

4-3 Ultrafast Recovery Diodes

V _{RM} (V)	I _F (AV) (A) <small>Values in parentheses are for the products with heatsinks</small>	Package Axial <small>(Body Diameter/Lead Diameter)</small>	Part Number	I _{FSM} (A) <small>50Hz Single Half Sine Wave</small>	T _J (°C)	T _{stg} (°C)	V _F (V) max	I _F (A)	I _R (μA) V _R =V _{RM} max	I _R (H) (mA) V _R =V _{RM} max	T _a (°C)	trr ⁽¹⁾ (ns)		trr ⁽²⁾ (ns)		R _{th(j-l)} (°C/W)	Mass (g)
												I _F /I _{RP} (mA)	I _F /I _{RP} (mA)				
200	10.0	TO-220F(Center-tap)	FMXB-2102	150	-40 to +150	0.98	10.0	200	50	150(T _J)	30	500/500	25	500/1000	4.0	2.1	
	10.0	TO-220F(Center-tap)	FML-22S	65	-40 to +150	0.98	5.0	250	1	100	40	100/100	30	100/200	4.0	2.1	
	10.0	TO-220F(Center-tap)	FMG-22S, R	65	-40 to +150	1.8	5.0	500	1.5	100	100	100/100	50	100/200	4.0	2.1	
	10.0	TO-220F(Center-tap)	FMX-22S	65	-40 to +150	0.98	5.0	100	20	100	30	100/100	25	100/200	4.0	2.1	
	10.0	TO-220F2Pin	FML-G22S	150	-40 to +150	0.98	10.0	500	2	100	40	500/500	30	500/1000	4.0	2.1	
	10.0	TO-220F2Pin	FMX-G22S	150	-40 to +150	0.98	10.0	200	50	100	30	500/500	25	500/1000	4.0	2.1	
	15.0	TO-220F(Center-tap)	FMX-22SL	100	-40 to +150	0.98	7.5	150	30	100	30	500/500	25	500/1000	4.0	2.1	
	20.0	TO-220F2Pin	FM2-2202	110	-40 to +150	0.98	10.0	200	400	150(T _J)	50	100/100	35	100/200	4.0	2.1	
20.0	TO-220F2Pin	FMXA-2202S	100	-40 to +150	1.2	10.0	100	30	150	25	500/500	—	—	4.0	2.1		
300	5.0	TO-220F(Center-tap)	FMG-13S, R	35	-40 to +150	1.8	2.5	500	1.5	100	100	100/100	50	100/200	4.0	2.1	
	5.0	TO-220F(Center-tap)	FML-13S	40	-40 to +150	1.3	2.5	50	0.1	100	50	100/100	35	100/200	4.0	2.1	
	5.0	TO-220F2Pin	FML-G13S	70	-40 to +150	1.3	5.0	100	0.2	100	50	100/100	35	100/200	4.0	2.1	
	10.0	TO-220F(Center-tap)	FMG-23S, R	65	-40 to +150	1.8	5.0	500	1.5	100	100	100/100	50	100/200	4.0	2.1	
	10.0	TO-220F(Center-tap)	FML-23S	70	-40 to +150	1.3	5.0	100	0.5	100	50	100/100	35	100/200	4.0	2.1	
	10.0	TO-220F(Center-tap)	FMX-23S	65	-40 to +150	1.3	5.0	50	15	150	30	100/100	25	100/200	4.0	2.1	
	15.0	TO-220F(Center-tap)	FMXA-2153S	75	-40 to +150	1.3	7.5	75	23	150(T _J)	25	500/500	—	—	4.0	2.1	
	20.0	TO-220F(Center-tap)	FMX-2203	100	-40 to +150	1.3	10.0	100	30	150	30	500/500	25	500/1000	4.0	2.1	
	20.0	TO-220F(Center-tap)	FMXA-2203S	100	-40 to +150	1.3	10.0	100	30	150	25	500/500	—	—	4.0	2.1	
20.0	TO-3PF(Center-tap)	FMXA-4203S	100	-40 to +150	1.3	10.0	100	30	150(T _J)	25	500/500	—	—	2.0	6.5		
400	0.7	Axial(φ2.4/φ0.6)	AG01	15	-40 to +150	1.8	0.7	100	0.5	100	100	100/100	50	100/200	22	0.13	
	0.7	Axial(φ2.7/φ0.6)	EG01	15	-40 to +150	2.0	0.7	50	0.3	100	100	100/100	50	100/200	20	0.2	
	0.8	Axial(φ2.7/φ0.78)	EG 1	15	-40 to +150	1.8	0.8	50	0.3	100	100	100/100	50	100/200	17	0.3	
	1.0	Axial(φ2.4/φ0.6)	AL01	20	-40 to +150	1.4	1.0	10	0.5	150(T _J)	50	100/100	35	100/200	22	0.13	
	1.2	Axial(φ4.0/φ0.78)	RG 10	50	-40 to +150	1.8	1.5	500	2.5	100	100	100/100	50	100/200	15	0.4	
	1.2	Axial(φ4.0/φ0.98)	RG 2	50	-40 to +150	1.8	1.5	500	2.5	100	100	100/100	50	100/200	12	0.6	
	1.5	Axial(φ2.7/φ0.78)	EL 1	20	-40 to +150	1.3	1.5	10	0.05	100	100	100/100	50	100/200	17	0.3	
	2.0	Axial(φ4.0/φ0.98)	RL 2	40	-40 to +150	1.3	2.0	10	0.1	150(T _J)	50	100/100	35	100/200	12	0.6	
	1.0(3.0)	Axial(φ6.5/φ1.4)	RG 4S	80	-40 to +150	1.8	3.0	500	2.5	100	100	100/100	50	100/200	8	1.2	
	3.5	Axial(φ5.2/φ1.2)	RL 3	80	-40 to +150	1.3	3.5	100	0.2	150(T _J)	50	100/100	35	100/200	10	1.0	
	5.0	TO-220F(Center-tap)	FMG-14S, R	35	-40 to +150	2.0	2.5	500	1.5	100	100	100/100	50	100/200	4.0	2.1	
	5.0	TO-220F(Center-tap)	FML-14S	40	-40 to +150	1.3	2.5	50	0.1	100	50	100/100	35	100/200	4.0	2.1	
	5.0	TO-220F2Pin	FMXA-1054S	50	-40 to +150	1.5	5.0	50	15	150	20	500/500	—	—	4.0	2.1	
	5.0	TO-220F2Pin	FMX-G14S	70	-40 to +150	1.3	5.0	50	15	150	30	100/100	25	100/200	4.0	2.1	
	5.0	TO-220F2Pin	FML-G14S	70	-40 to +150	1.3	5.0	100	0.2	100	50	100/100	35	100/200	4.0	2.1	
	5.0	TO-220F2Pin	FMN-G14S	70	-40 to +150	1.0	5.0	50	10	150(T _J)	100	100/100	50	100/200	4.0	2.1	
	8.0	TO-220F(Center-tap)	FMG-24S, R	65	-40 to +150	2.0	5.0	500	2.5	100	100	100/100	50	100/200	4.0	2.1	
10.0	TO-220F(Center-tap)	FML-24S	70	-40 to +150	1.3	5.0	100	0.2	100	50	100/100	35	100/200	4.0	2.1		
10.0	TO-220F2Pin	FMXA-1104S	100	-40 to +150	1.5	10.0	100	30	150(T _J)	25	500/500	—	—	4.0	2.1		
16.0	TO-220F(Center-tap)	FMXJ-2146S	100	-40 to +150	1.4	8.0	100	20	150(T _J)	18	500/500	—	—	4.0	2.1		
600	0.5	Axial(φ2.7/φ0.6)	EG01A	10	-40 to +150	2.0	0.5	100	0.5	100	100	100/100	50	100/200	20	0.2	
	0.5	Axial(φ2.4/φ0.6)	AG01A	15	-40 to +150	1.8	0.5	100	0.5	100	100	100/100	50	100/200	22	0.13	
	0.6	Axial(φ2.7/φ0.78)	EG 1A	10	-40 to +150	2.0	0.6	100	0.5	100	100	100/100	50	100/200	17	0.3	
	1.0	Axial(φ4.0/φ0.78)	RG 10A	50	-40 to +150	2.0	1.0	500	2.5	100	100	100/100	50	100/200	15	0.4	
	1.0	Axial(φ4.0/φ0.98)	RG 2A	50	-40 to +150	2.0	1.0	500	2.5	100	100	100/100	50	100/200	12	0.6	
	1.2	Axial(φ4.0/φ0.98)	RD 2A	30	-40 to +150	1.55	1.2	50	0.1	150(T _J)	50	100/100	35	100/200	12	0.6	
	2.0	Axial(φ5.2/φ1.2)	RL 3A	60	-40 to +150	1.7	3.0	50	0.2	150(T _J)	50	100/100	35	100/200	10	1.0	
	3.0	TO-220F(Two elements)	FMC-26U	50	-40 to +150	2.0	3.0	500	3	150(T _J)	70	500/500	35	500/1000	4.0	2.1	
	3.0	Axial(φ6.5/φ1.4)	RL 4A	80	-40 to +150	1.5	3.0	50	0.1	150(T _J)	50	500/500	35	500/1000	8	1.2	
	4.0	TO-220F2Pin	FMG-G26S	50	-40 to +150	2.5	4.0	500	3	100	100	100/100	50	100/200	4.0	2.1	
	5.0	TO-220F2Pin	FMX-G16S	50	-40 to +150	1.5	5.0	50	15	150	30	100/100	25	100/200	4.0	2.1	
	5.0	TO-220F2Pin	FML-G16S	50	-40 to +150	1.5	5.0	100	0.5	100	50	500/500	35	500/1000	4.0	2.1	
	5.0	TO-220F2Pin	FMN-G16S	50	-40 to +150	1.2	5.0	50	10	150(T _J)	100	100/100	50	100/200	4.0	2.1	
6.0	TO-220F(Center-tap)	FMG-26S, R	50	-40 to +150	2.2	3.0	500	3	100	100	100/100	50	100/200	4.0	2.1		

• No. 13 Axial ($\phi 2.7/\phi 0.6$)

Silicon Varistors (Symmetrical)

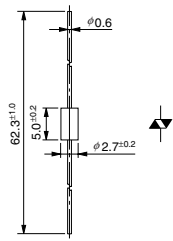

• No. 14 Axial ($\phi 2.7/\phi 0.78$)

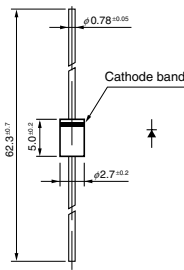

• No. 15 Axial ($\phi 4.0/\phi 0.78$)

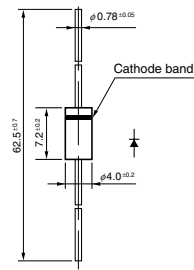

• No. 16 Axial ($\phi 4.0/\phi 0.98$)

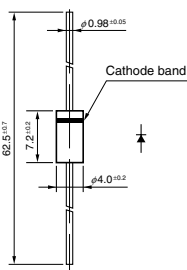

• No. 17 Axial ($\phi 5.2/\phi 1.2$)

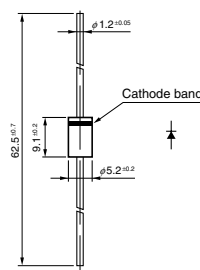

• No. 18 Axial ($\phi 6.5/\phi 1.4$)

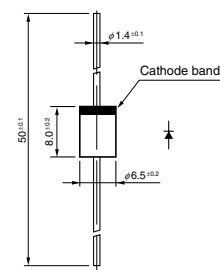

• No. 19 Axial ($\phi 10.0/\phi 1.3$)

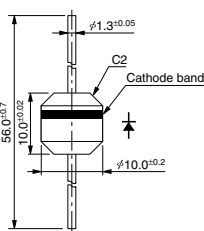

• No. 20 TO-220F (Two Elements)

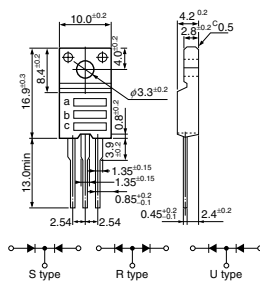

a: Part Number
b: Polarity
c: Lot No.

• No. 21 TO-220F (Center-tap)

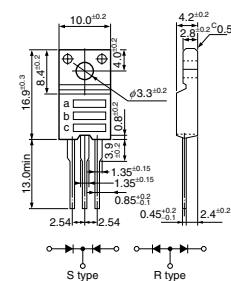

a: Part Number
b: Polarity
c: Lot No.

• No. 22 TO-220F2Pin

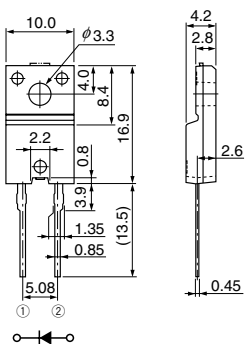

• No. 23 TO-220F2Pin (Two Elements)

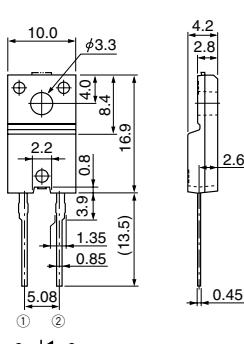

• No. 24 TO-3PF

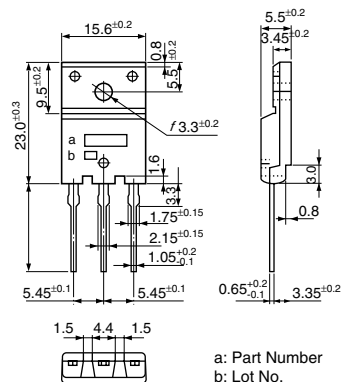

a: Part Number
b: Lot No.