



Muffin XL - MD12B2 - 028868 - No
 (Family) (Model) (Part #) (In Stock)

Electrical Specifications

| | |
|----------------------|--------------|
| Operating Voltage: | 12 Volts |
| Voltage Range: | 6 - 14 Volts |
| Power Supply: | 6.0 Watts |
| Line Current: | 0.50 Amps |
| Locked Rotor Current | 1.65 Amps |
| Nominal Speed: | 3330 RPM |



Mechanical Specifications

| | |
|-------------------------------------|---------------------------|
| Dimensions: | 4.7 x 4.7 x 1.5 in |
| Weight | 21.52 oz |
| Max Airflow @ 0 in H ₂ O | 110.0 CFM |
| Max Pressure @ 0 CFM | 0.278 in H ₂ O |
| Noise | 50.0 dBA |



Mechanical Drawing

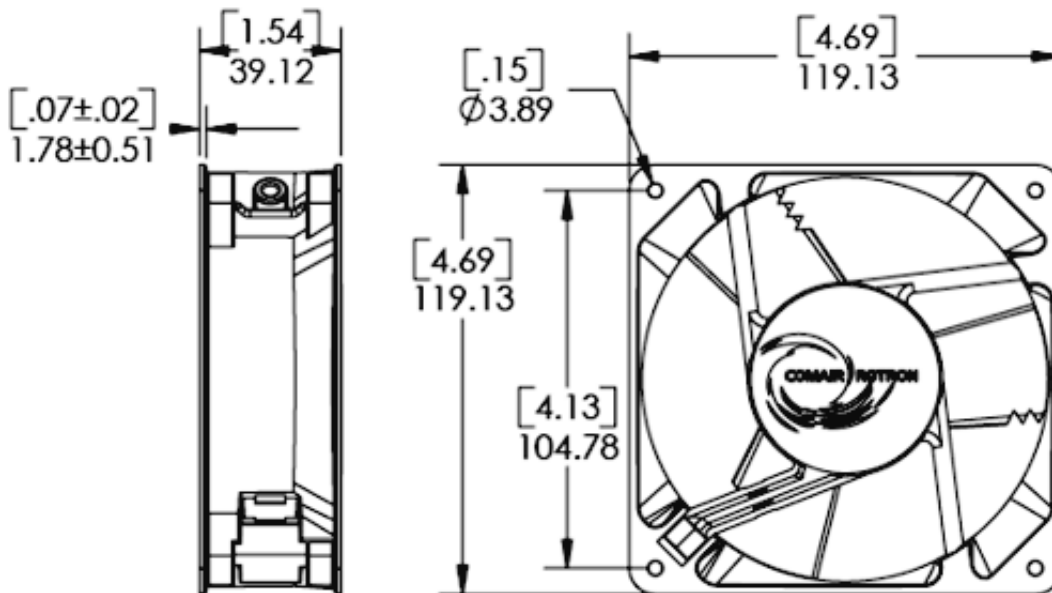

Comair Rotron, Inc.
 Phone: 619.651.2000
 sales@comairrotron.com

Comair Rotron Europe, Ltd.
 Phone: +44.1527.520525
 saleseurope@comairrotron.com

Comair Rotron Fan Company Ltd.
 Phone: +86.21.52260581
 salesasia@comairrotron.com

Print Date: Thursday, March 22, 2012 at 23:15:29 - DC Fan Datasheet - Web Version 1.0 Rev. B



Fan Performance Curve

Fan Configuration Options

Muffin XL (Family) **MD12B2** (Model) / **028868** (Part #) **No** (In Stock) **Terminals** (Features)

Fan Speed: 3330 RPM **Fan Bearings:** Ball Bearings
Fan Airflow Direction: Flow L (CW Rotation) **Fan Termination:** Terminals

Fan Monitoring Options: No Fan Monitoring Options Selected

Fan Speed Control Option: No ThermaPro-V Fan Speed Control Options Selected

Environmental Protection Options: No Enviroshield Options Selected

Comair Rotron, Inc.
 Phone: 619.651.2000
 sales@comairrotron.com

Comair Rotron Europe, Ltd.
 Phone: +44.1527.520525
 saleseurope@comairrotron.com

Comair Rotron Fan Company Ltd.
 Phone: +86.21.52260581
 salesasia@comairrotron.com

Print Date: Thursday, March 22, 2012 at 23:15:29 - DC Fan Datasheet - Web Version 1.0 Rev. B



Accessories (Click on part number for detailed drawing.)

571064
Plug and Cord



550113
Mounting Clip

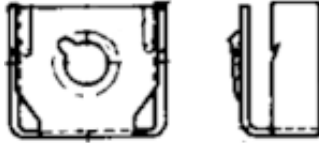

551590
Filter Assembly
Mounting Bracket Filter Frame
Filter Element
Fan Venturi Edge

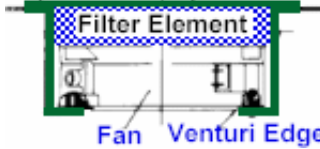

554148
Filter Guard Assembly

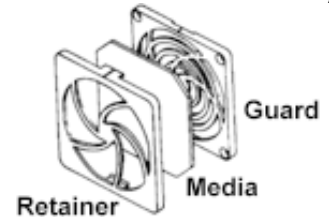

552934
Finger Guard



476042
Finger Guard

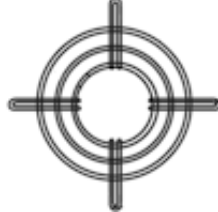

550481
Finger Guard

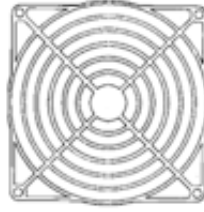

551147
Finger Guard

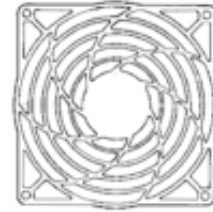

Comair Rotron, Inc.
Phone: 619.651.2000
sales@comairrotron.com

Comair Rotron Europe, Ltd.
Phone: +44.1527.520525
saleseurope@comairrotron.com

Comair Rotron Fan Company Ltd.
Phone: +86.21.52260581
salesasia@comairrotron.com

Print Date: Thursday, March 22, 2012 at 23:15:29 - DC Fan Datasheet - Web Version 1.0 Rev. B