

# Analog Devices Welcomes Hittite Microwave Corporation

NO CONTENT ON THE ATTACHED DOCUMENT HAS CHANGED



**THIS PAGE INTENTIONALLY LEFT BLANK**

### Typical Applications

The HMC1063LP3E is ideal for:

- Point-to-Point and Point-to-Multi-Point Radio
- Military Radar, EW & ELINT
- Satellite Communications
- Sensors

### Features

- Low LO Power: 10 dBm
- Wide IF Bandwidth: DC - 3 GHz
- Image Rejection: 21 dBc
- LO / RF Isolation: 40 dB
- High Input IP3: 17 dBm
- 16 Lead 3x3 mm SMT Package: 9 mm<sup>2</sup>

### Functional Diagram

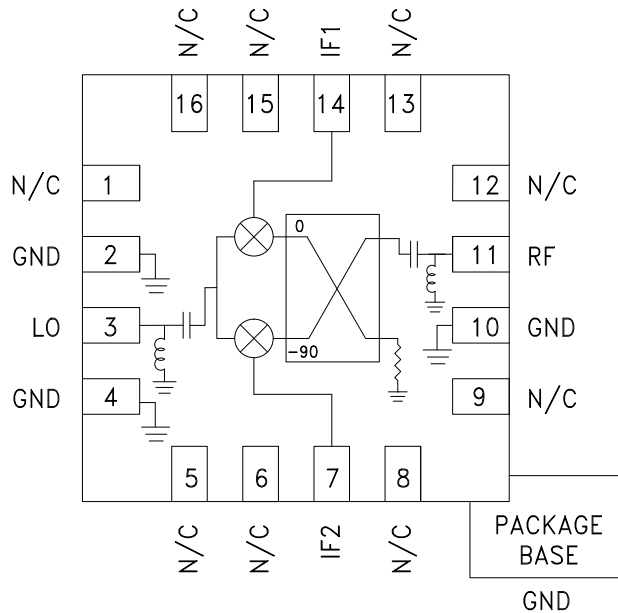

### General Description

The HMC1063LP3E is a compact I/Q MMIC mixer in a leadless "Pb free" SMT package, which can be used as either an Image Reject Mixer or a Single Sideband Upconverter. The mixer utilizes two standard Hittite double balanced mixer cells and a 90 degree hybrid fabricated in a GaAs Schottky diode process. A low frequency quadrature hybrid was used to produce a 1000 MHz LSB IF output. This product is a much smaller alternative to hybrid style Image Reject Mixers and Single Sideband Upconverter assemblies. The HMC1063LP3E eliminates the need for wire bonding and allows the use of surface mount manufacturing techniques.

### Electrical Specifications <sup>[1][2]</sup>, $T_A = +25^\circ\text{C}$ , $IF = 1000\text{ MHz}$ , $LSB$ , $LO = +10\text{ dBm}$

Parameter	Min.	Typ.	Max.	Min.	Typ.	Max.	Units
Frequency Range, RF		24 - 27			27 - 28		GHz
Frequency Range, LO		21 - 30			24 - 31		GHz
Frequency Range, IF		DC - 3			DC - 3		GHz
Conversion Gain	-11.5	-9.5		-11.5	-9.5		dB
Image Rejection	15	21		13	21		dBc
LO to RF Isolation	30	42		28	36		dB
LO to IF Isolation		40			40		dB
IP3 (Input)		18			16		dBm
Amplitude Balance <sup>[2]</sup>		1			1		dB
Phase Balance <sup>[2]</sup>		-2			+2		Deg

[1] Unless otherwise noted all measurements performed as downconverter.

[2] Data taken without external 90° hybrid.

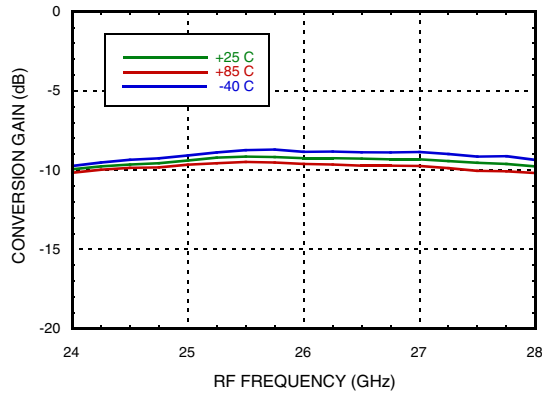
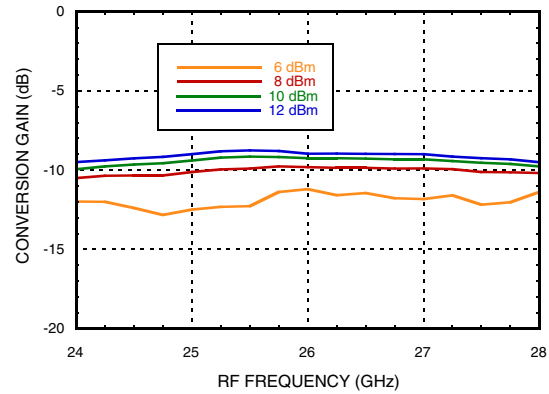
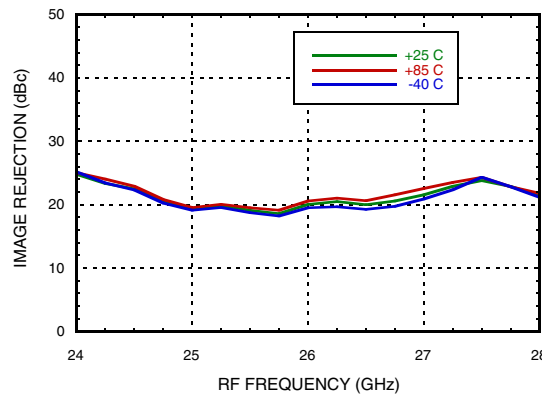
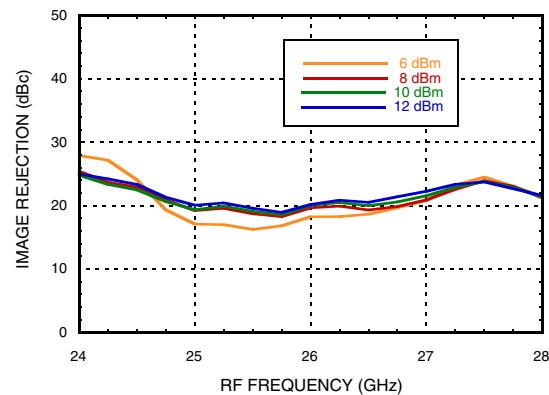
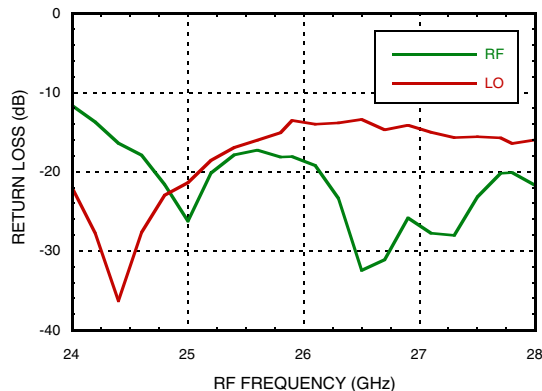
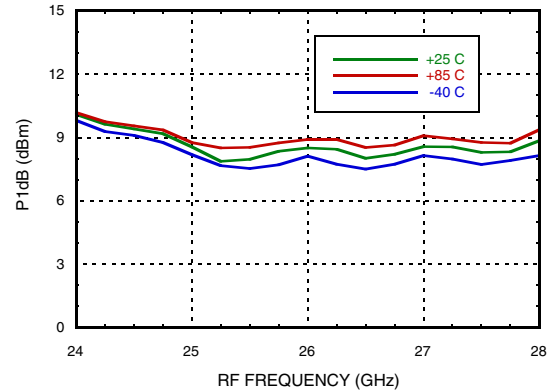

**Data Taken as SSB Downconverter with External IF 90° Hybrid, IF = 1000 MHz**

**Conversion Gain, LSB vs. Temperature**

**Conversion Gain, LSB vs. LO Drive**

**Image Rejection, LSB vs. Temperature**

**Image Rejection, LSB vs. LO Drive**

**Return Loss**

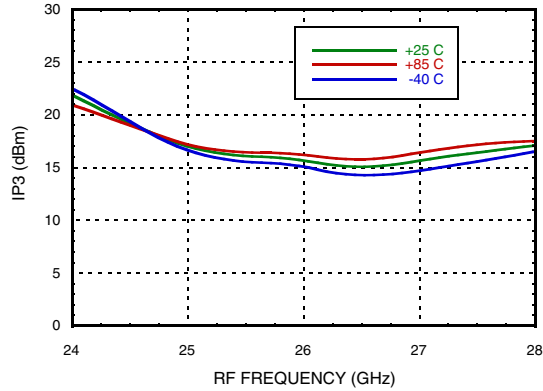
**Input P1dB, LSB vs. Temperature**

[1] Data taken without external IF 90° hybrid



Data Taken as SSB Downconverter with External IF 90° Hybrid, IF = 1000 MHz

**Input IP3, LSB vs. Temperature**



**Input IP3, LSB vs. LO Drive**

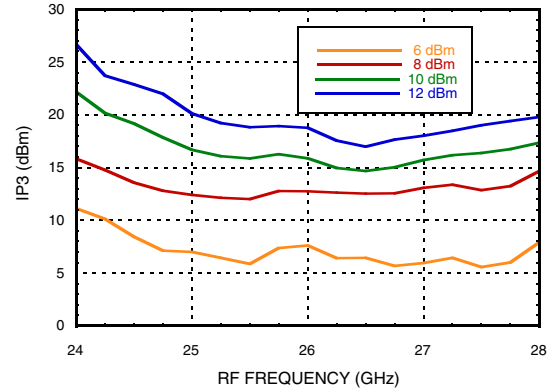

**Isolations**

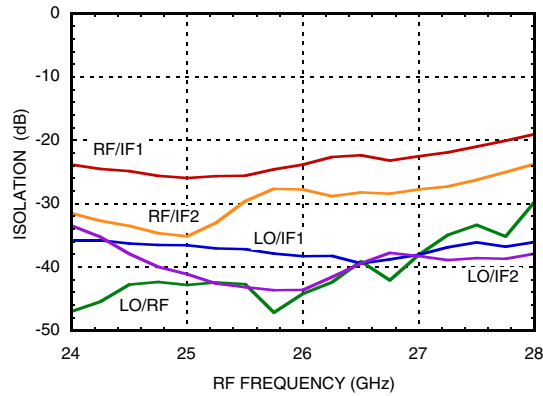

**IF Bandwidth\***

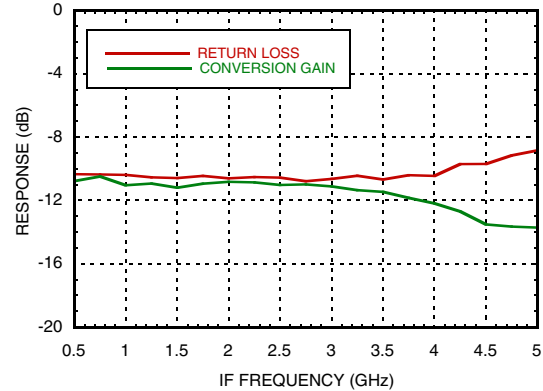

**Amplitude Balance, LSB vs. LO Drive**

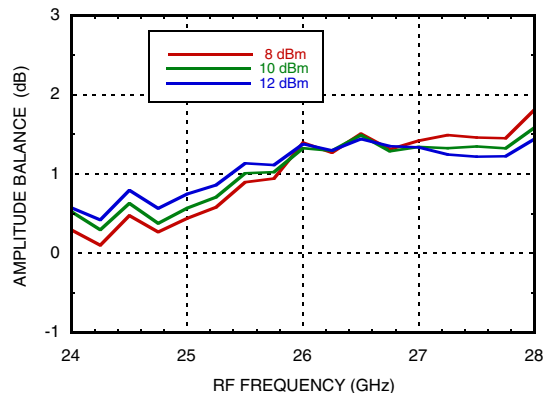

**Phase Balance, LSB vs. LO Drive**

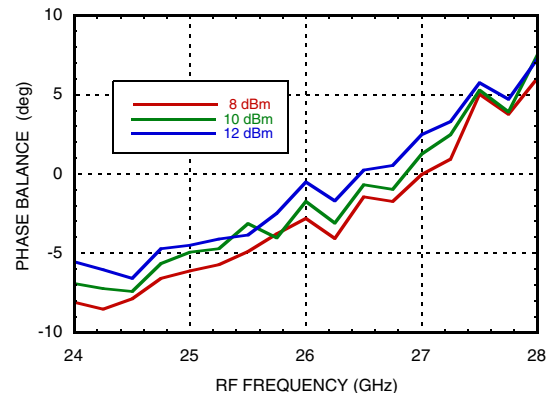

\* Conversion gain data taken with external IF hybrid.



**Data Taken as SSB Downconverter with External IF 90° Hybrid, IF = 1000 MHz**

**Upconverter Performance, Conversion Gain, LSB vs. LO Drive**

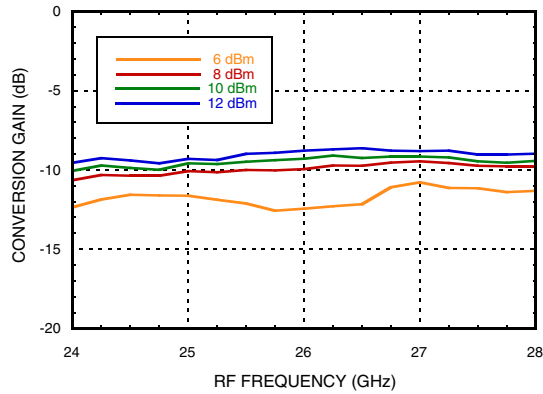

**Upconverter Performance, Sideband Rejection, LSB vs. LO Drive,**

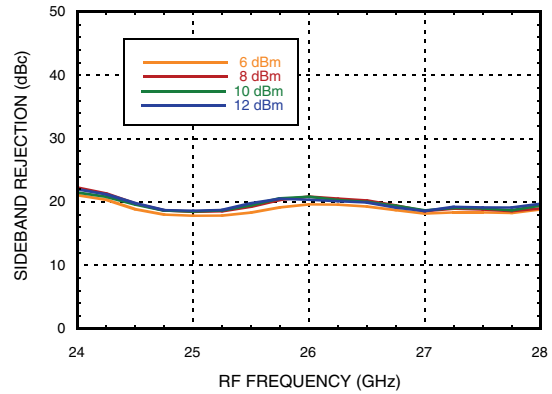

**Conversion Gain, USB vs. Temperature**

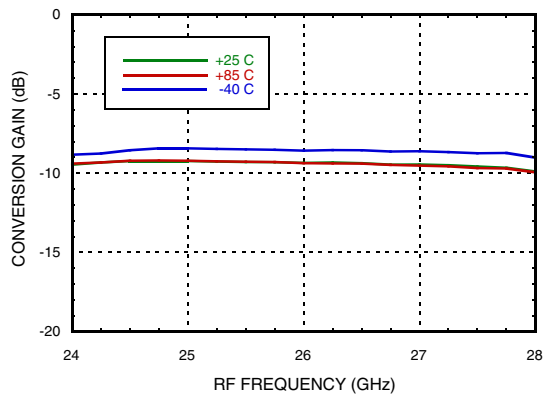

**Conversion Gain, USB vs. LO Drive**

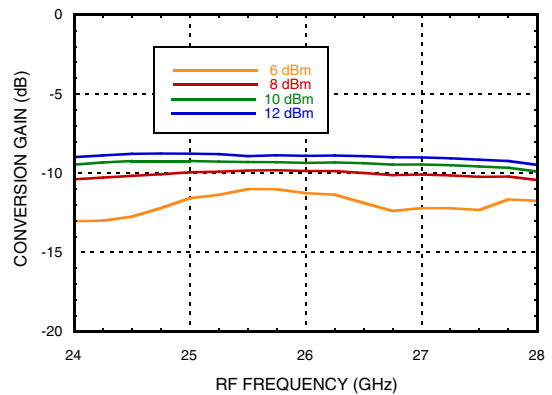

**Image Rejection, USB vs. Temperature**

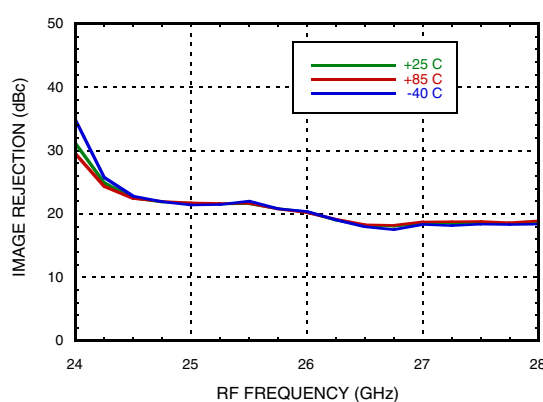

**Image Rejection, USB vs. LO Drive**

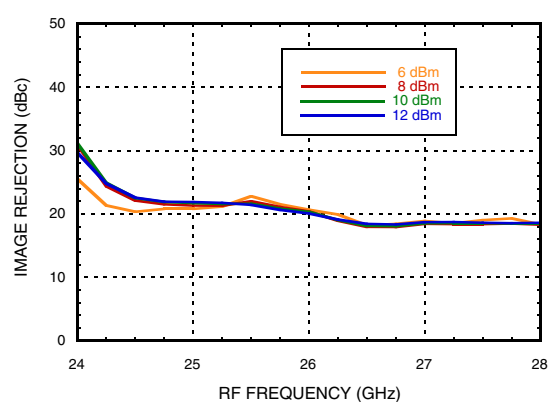



Data Taken as SSB Downconverter with External IF 90° Hybrid, IF = 1000 MHz

**Input P1dB, USB vs. Temperature**

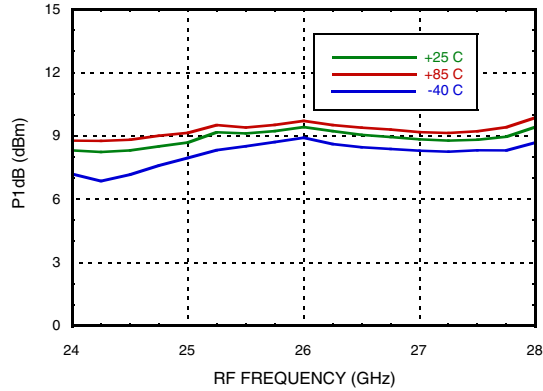

**Input IP3, USB vs. Temperature**

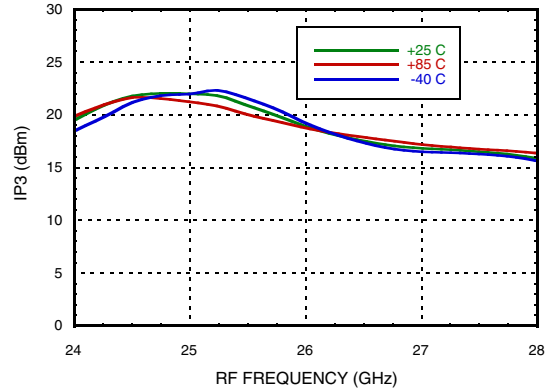

**Input IP3, USB vs. LO Drive**

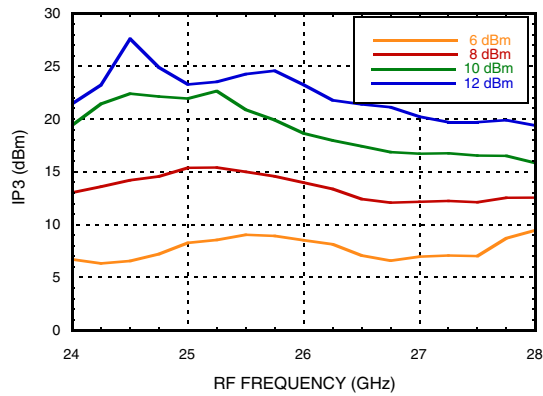

**Amplitude Balance, USB vs. LO Drive**

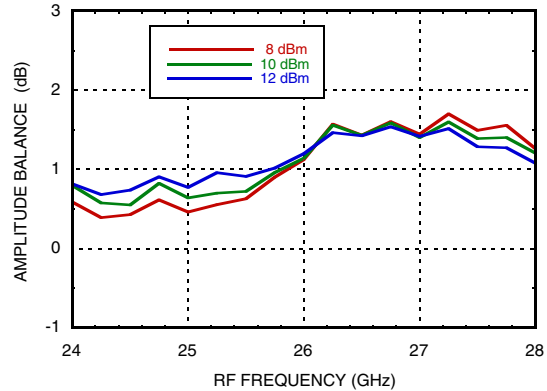

**Phase Balance, USB vs. LO Drive**

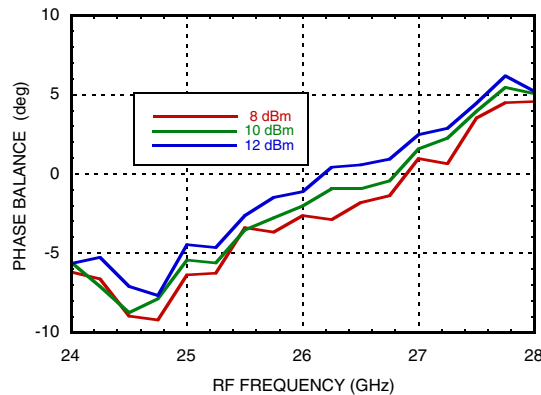



**Data Taken as SSB Upconverter with External IF 90° Hybrid, IF = 1000 MHz**

**Upconverter Performance, Conversion Gain, USB vs. LO Drive**

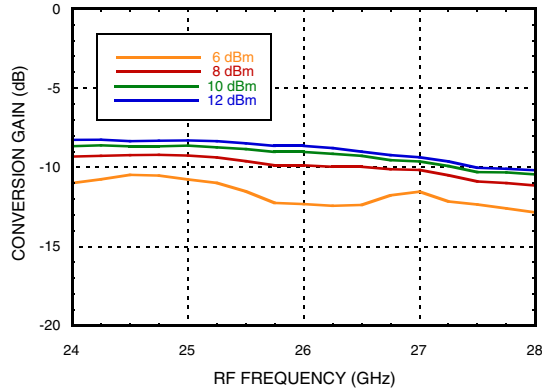

**Upconverter Performance, Sideband Rejection, USB vs. LO Drive,**

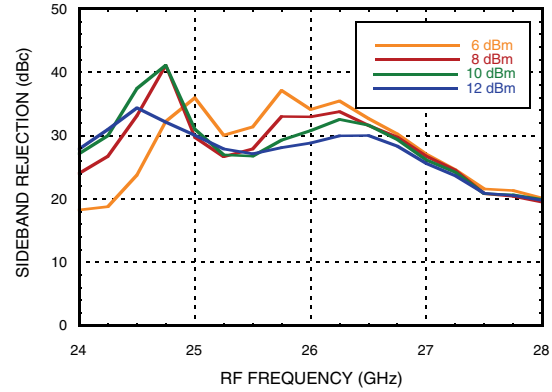





Data Taken as SSB Downconverter with External IF 90° Hybrid, IF = 3000 MHz

**Conversion Gain, LSB vs. Temperature**

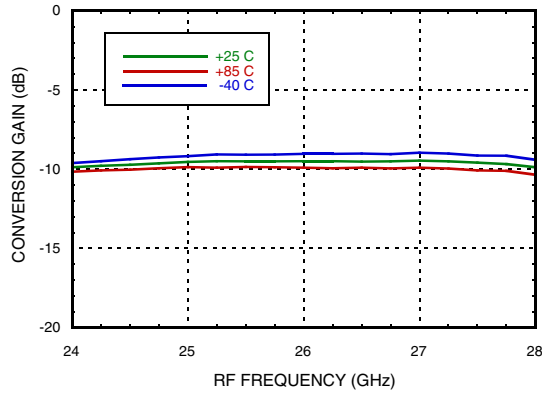

**Conversion Gain, LSB vs. LO Drive**

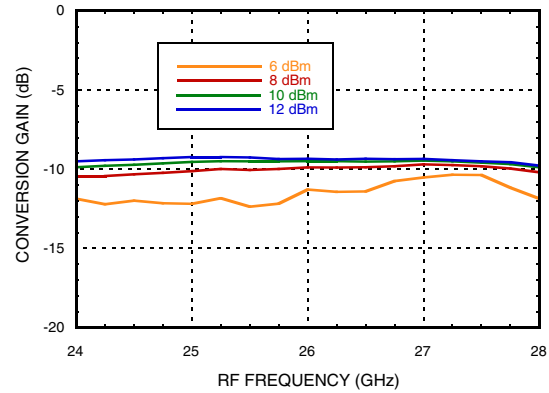

**Image Rejection, LSB vs. Temperature**

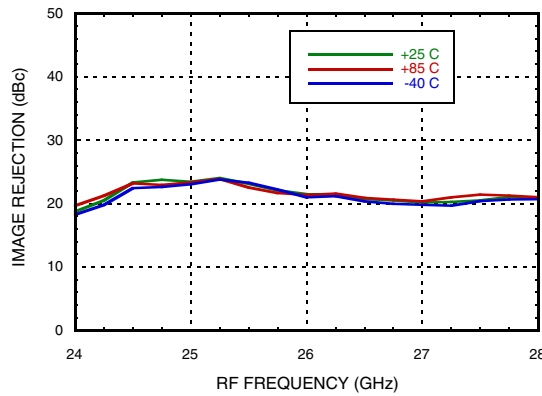

**Image Rejection, LSB vs. LO Drive**

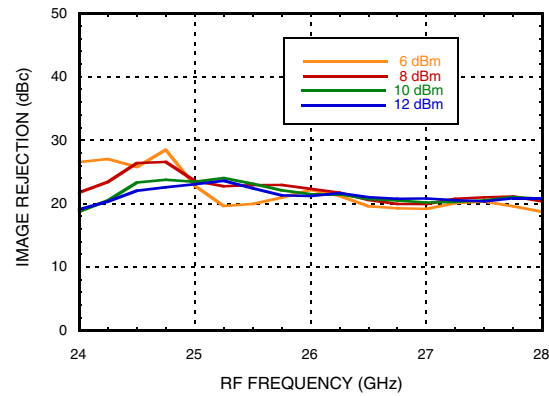

**Input IP3, LSB vs. Temperature**

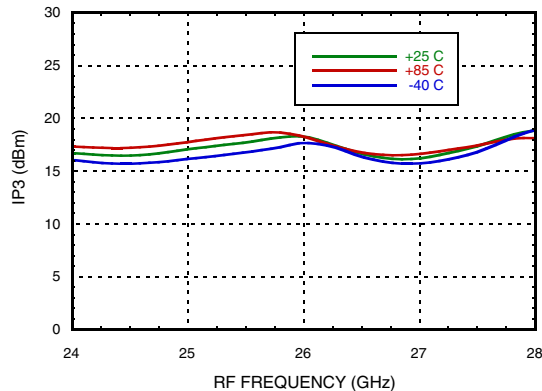

**Input IP3, LSB vs. LO Drive**

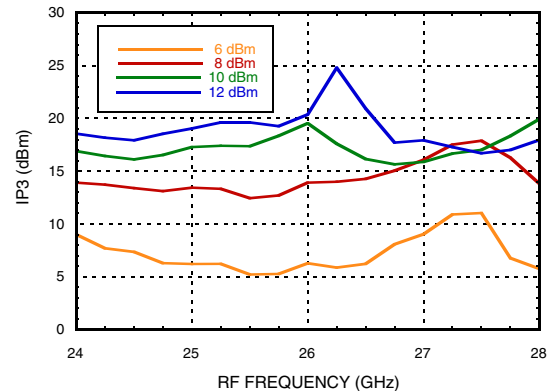



Data Taken as SSB Downconverter with External IF 90° Hybrid, IF = 3000 MHz

**Upconverter Performance, Conversion Gain, LSB vs. LO Drive**

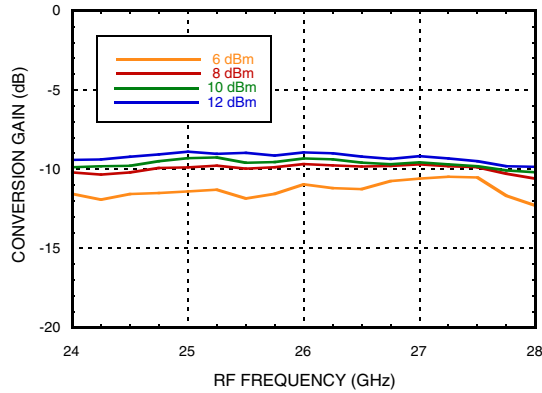

**Upconverter Performance, Sideband Rejection, LSB vs. LO Drive,**

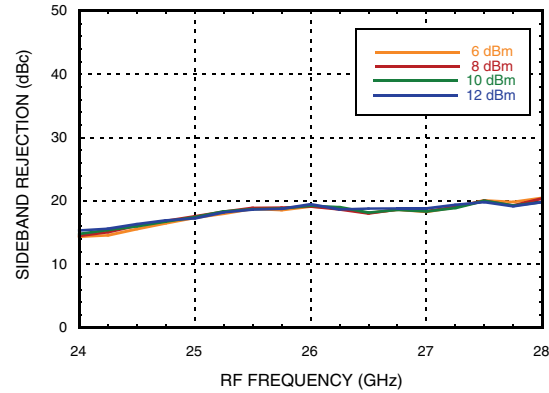

**Conversion Gain, USB vs. Temperature**

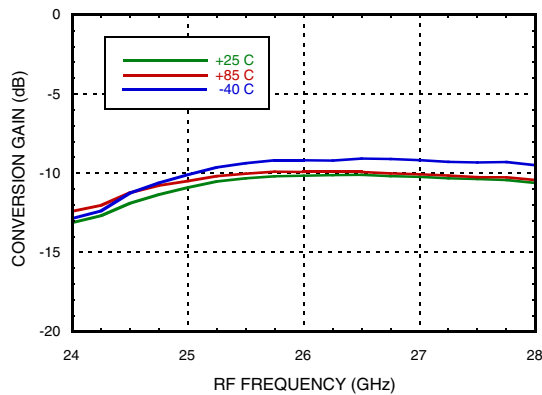

**Conversion Gain, USB vs. LO Drive**

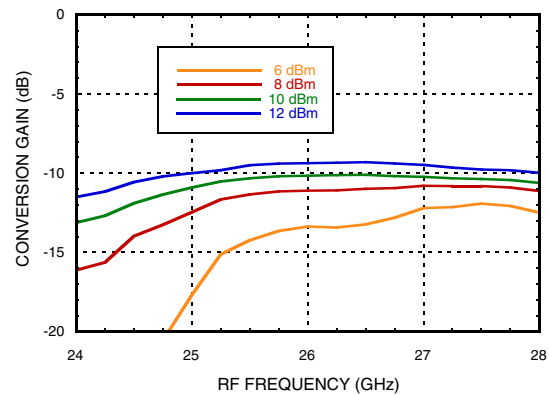

**Image Rejection, USB vs. Temperature**

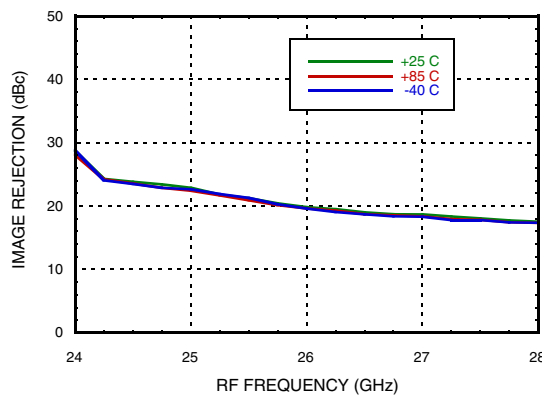

**Image Rejection, USB vs. LO Drive**

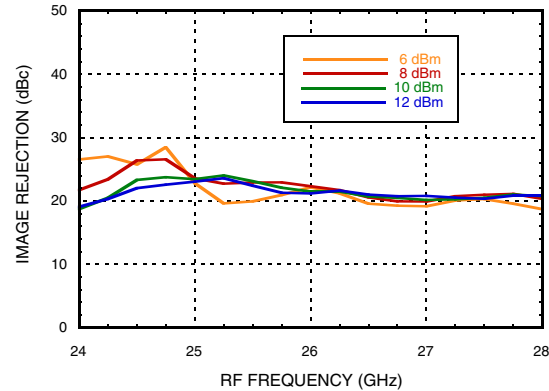



Data Taken as SSB Downconverter with External IF 90° Hybrid, IF = 3000 MHz

**Input IP3, USB vs. Temperature**

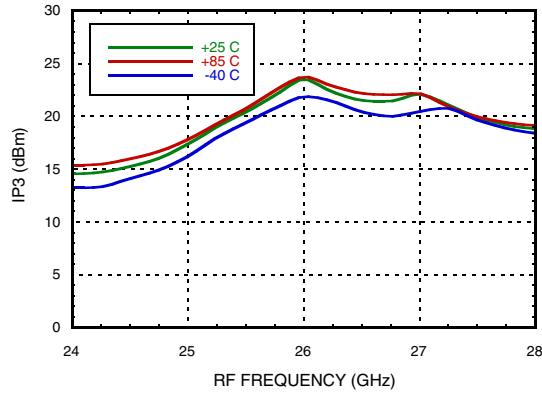

**Input IP3, USB vs. LO Drive**

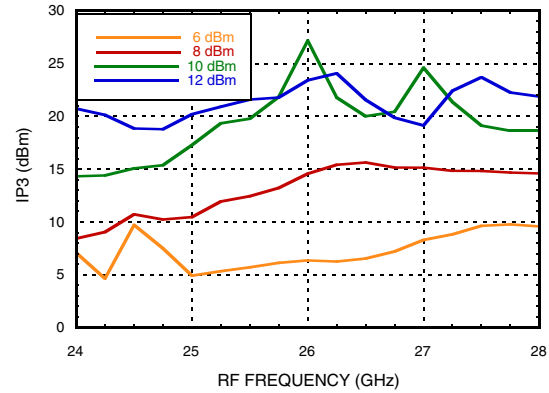

**Upconverter Performance, Conversion Gain, USB vs. LO Drive**

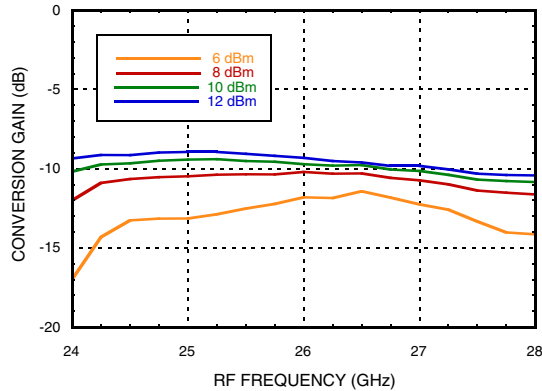

**Upconverter Performance, Sideband Rejection, USB vs. LO Drive**

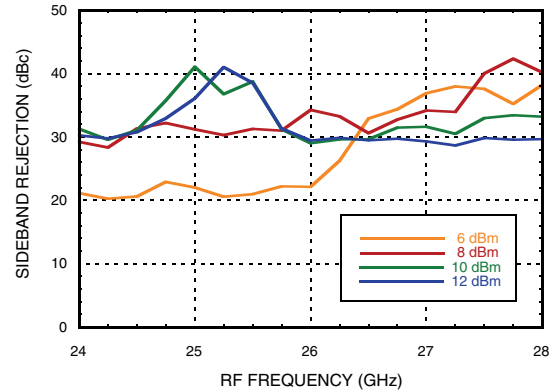

**Harmonics of LO**

LO Freq. (GHz)	nLO Spur at RF Port		
	1	2	3
23	36.6	43.3	x
24	33.8	46.4	x
25	32.1	49.4	x
26	29.6	x	x
27	31.8	x	x
28	32.8	x	x

LO = + 10 dBm  
Values in dBc below LO level measured at RF Port.

**MxN Spurious Outputs**

mRF	nLO				
	0	1	2	3	4
0	XX	1	28	x	x
1	8	0	34	60	x
2	95	53	51	58	87
3	x	97	97	97	97
4	x	x	x	97	97

RF = 22 GHz @ -10 dBm

LO = 23 GHz @ +10 dBm

Data taken without IF hybrid

All values in dBc below IF power level

**Absolute Maximum Ratings**

IF Input (At LO = 10 dBm and RF = -10 dBm)	+11.5 dBm
RF Input (At 10 dBm LO Power)	+13 dBm
LO Input (At -10 dBm RF Power)	+14.5 dBm
Channel Temperature	175 °C
Continuous Pdiss (T = 85°C) (derate 6 mW/°C above 85°C)	550 mW
Thermal Resistance (channel to ground paddle)	164 °C/W
Storage Temperature	-65 to +150 °C
Operating Temperature	-40 to +85 °C
ESD Sensitivity (HBM)	Class 1A

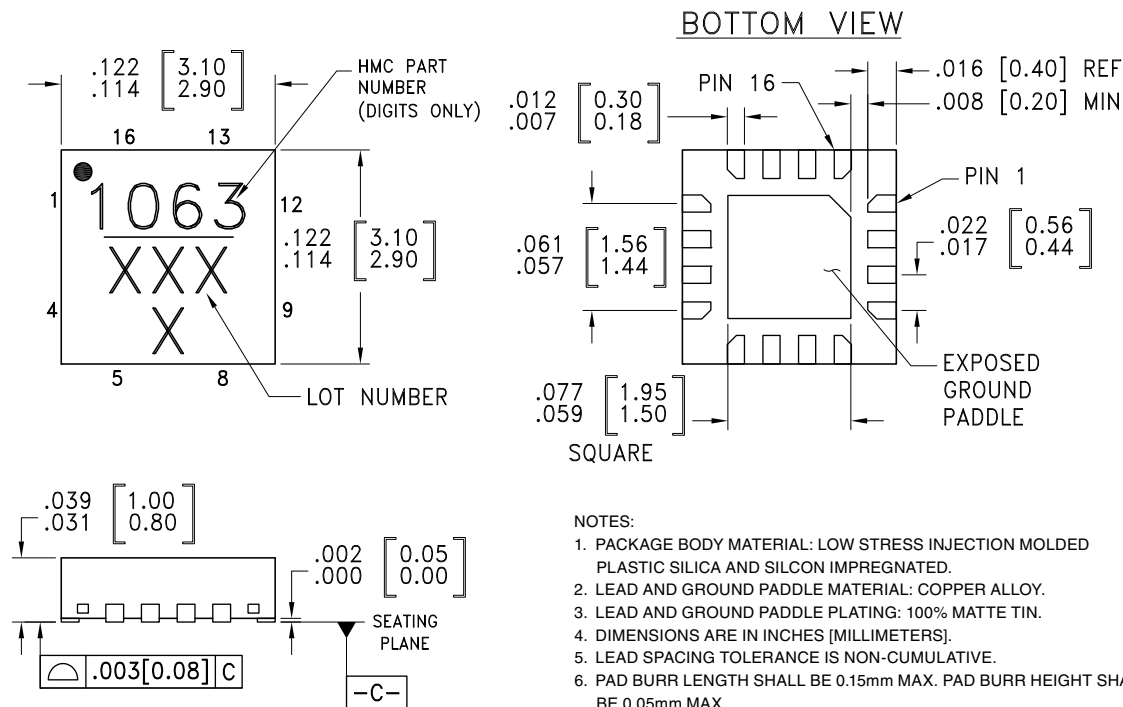
**ELECTROSTATIC SENSITIVE DEVICE  
OBSERVE HANDLING PRECAUTIONS**
**Outline Drawing**

**NOTES:**

1. PACKAGE BODY MATERIAL: LOW STRESS INJECTION MOLDED PLASTIC SILICA AND SILICON IMPREGNATED.
2. LEAD AND GROUND PADDLE MATERIAL: COPPER ALLOY.
3. LEAD AND GROUND PADDLE PLATING: 100% MATTE TIN.
4. DIMENSIONS ARE IN INCHES [MILLIMETERS].
5. LEAD SPACING TOLERANCE IS NON-CUMULATIVE.
6. PAD BURR LENGTH SHALL BE 0.15mm MAX. PAD BURR HEIGHT SHALL BE 0.05mm MAX.
7. PACKAGE WARP SHALL NOT EXCEED 0.05mm.
8. ALL GROUND LEADS AND GROUND PADDLE MUST BE SOLDERED TO PCB RF GROUND.

**Package Information**

Part Number	Package Body Material	Lead Finish	MSL Rating <sup>[2]</sup>	Package Marking <sup>[1]</sup>
HMC1063LP3E	RoHS-compliant Low Stress Injection Molded Plastic	100% matte Sn	MSL1	H1063 XXXX

[1] 4-Digit lot number XXXX

[2] Max peak reflow temperature of 260 °C

For price, delivery and to place orders: Hittite Microwave Corporation, 2 Elizabeth Drive, Chelmsford, MA 01824

Phone: 978-250-3343 Fax: 978-250-3373 Order On-line at [www.hittite.com](http://www.hittite.com)

Application Support: Phone: 978-250-3343 or [apps@hittite.com](mailto:apps@hittite.com)

**Pin Descriptions**

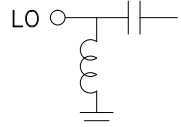
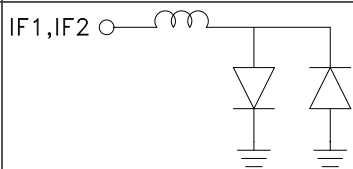
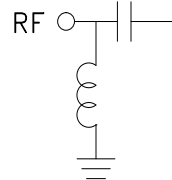
Pin Number	Function	Description	Interface Schematic
1, 5, 6, 8, 9, 12, 13, 15, 16	N/C	These pins are not connected internally; however, all data shown herein was measured with these pins connected to RF/DC ground externally.	
2, 4, 10	GND	These pins and exposed ground paddle must be connected to RF/DC ground	
3	LO	This pin is DC coupled and matched to 50 Ohms	
7	IF2	Differential IF input pins. For applications not requiring operation to DC, an off chip DC blocking capacitor should be used. For operation to DC this pin must not source/sink more than 3 mA of current or part non function and and possible part failure will result.	
14	IF1		
11	RFOUT	This pin is DC coupled and matched to 50 Ohms.	

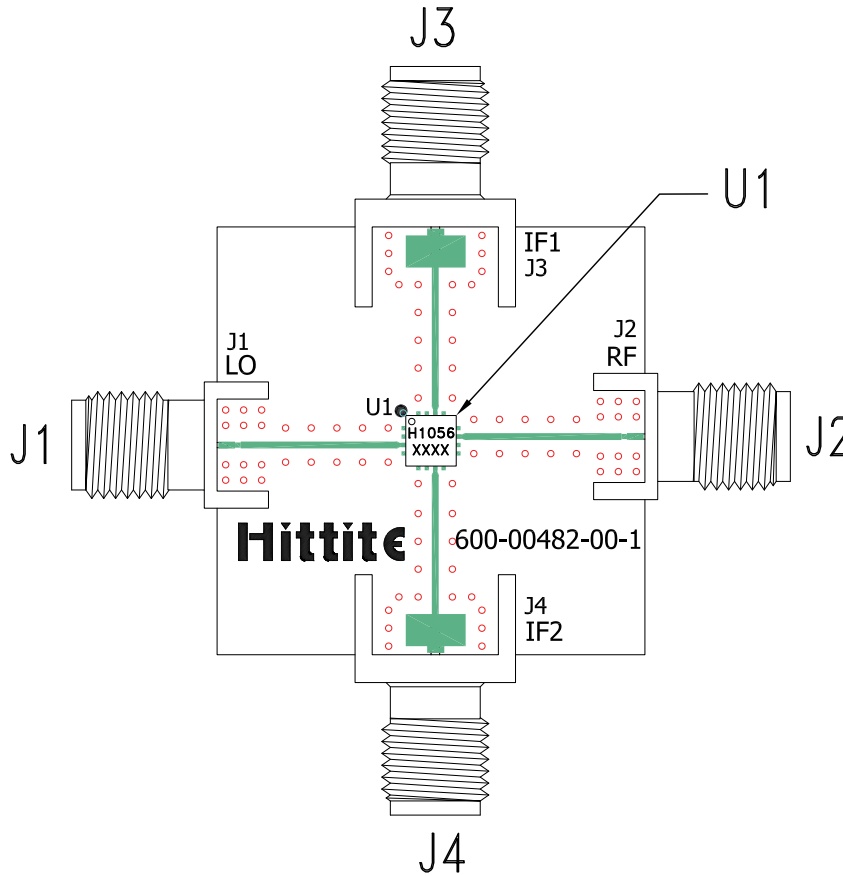
**Evaluation PCB**

**List of Materials for Evaluation PCB EVAL01-HMC1063LP3 [1]**

Item	Description
J1, J2	PCB mount K Connector SRI
J3, J4	PCB mount SMA Connector Johnson
U1	HMC1063LP3E Downconverter
PCB [2]	600-00482-00-1 Evaluation Board

[1] Reference this number when ordering complete evaluation PCB

[2] Circuit Board Material: Arlon 25FR, FR4 or Rogers 4350

The circuit board used in the application should use RF circuit design techniques. Signal lines should have 50 Ohm impedance while the package ground leads and exposed paddle should be connected directly to the ground plane similar to that shown. A sufficient number of via holes should be used to connect the top and bottom ground planes. The evaluation circuit board shown is available from Hittite upon request.



**Notes:**