

40MHz to 3.8GHz RF Power Detector with 75dB Dynamic Range

FEATURES

- Frequency Range: 40MHz to 3.8GHz
- 75dB Log Linear Dynamic Range
- Exceptional Accuracy over Temperature
- Linear DC Output vs. Input Power in dBm
- -72dBm Detection Sensitivity
- Single-ended RF Input
- Low Supply Current: 29mA
- Supply Voltage: 3V to 5.25V
- 8-lead DFN 3mm × 3mm package

APPLICATIONS

- Received Signal Strength Indication (RSSI)
- RF Power Measurement and Control
- RF/IF Power Detection
- Receiver RF/IF Gain Control
- Envelope Detection
- ASK Receiver

DESCRIPTION

The LT[®]5538 is a 40MHz to 3800MHz monolithic logarithmic RF power detector, capable of measuring RF signals over a wide dynamic range, from -75dBm to 10dBm. The RF signal in an equivalent decibel-scaled value is precisely converted into DC voltage on a linear scale. The wide linear dynamic range is achieved by measuring the RF signal using cascaded RF limiters and RF detectors. Their outputs are summed to generate an accurate linear DC voltage proportional to the input RF signal in dBm. The LT5538 delivers superior temperature stable output (within ±1dB over full temperature range) from 40MHz to 3.8GHz. The output is buffered with a low impedance driver.

LT, LT, LTC and LTM are registered trademarks of Linear Technology Corporation. All other trademarks are the property of their respective owners.

TYPICAL APPLICATION

40MHz - 3.8GHz Logarithmic RF Detector

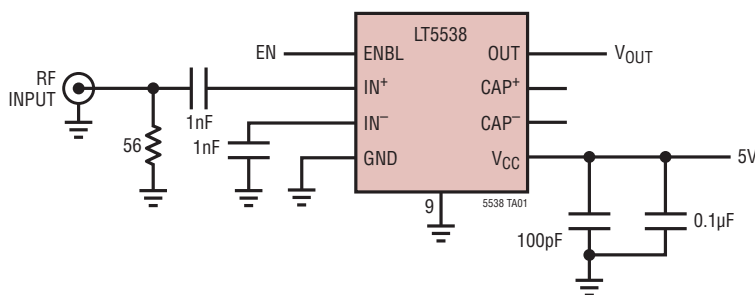

Output Voltage and Linearity Error vs Input Power

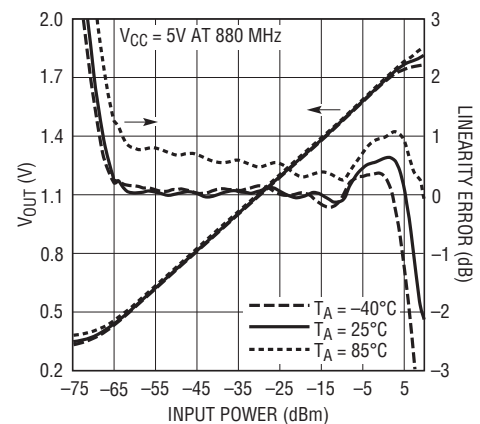

5538 TA02

ABSOLUTE MAXIMUM RATINGS

(Note 1)

Power Supply Voltage	5.5V
Enable Voltage	-0.3V, $V_{CC} + 0.3V$
RF Input Power	15dBm
Operating Ambient Temperature	-40°C to +85°C
Storage Temperature Range.....	-65°C to +125°C
Maximum Junction Temperature.....	150°C

PIN CONFIGURATION

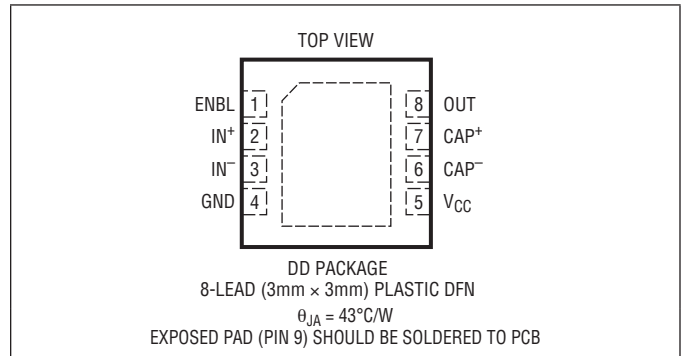

ORDER INFORMATION

LEAD FREE FINISH	TAPE AND REEL	PART MARKING	PACKAGE DESCRIPTION	TEMPERATURE RANGE
LT5538IDD#PBF	LT5538IDD#TRPBF	LCVCG	8-Lead (3mm × 3mm) Plastic DFN	-40°C to 85°C

Consult LTC Marketing for parts specified with wider operating temperature ranges.

Consult LTC Marketing for information on non-standard lead based finish parts.

For more information on lead free part marking, go to: <http://www.linear.com/leadfree/>

For more information on tape and reel specifications, go to: <http://www.linear.com/tapeandreeel/>

ELECTRICAL CHARACTERISTICS

The ● denotes the specifications which apply over the full operating temperature range, otherwise specifications are at $T_A = 25^{\circ}\text{C}$, $V_{CC} = 5V$, $ENBL = 5V$. (Note 2)

SYMBOL	PARAMETER	CONDITIONS	MIN	TYP	MAX	UNITS
RF Input						
	Input Frequency Range			40 to 3800		MHz
	DC Common Mode Voltage			$V_{CC} - 0.5$		V
	Input Resistance			394		Ω
$f_{RF} = 40\text{ MHz}$						
	RF Input Power Range			-75 to 10		dBm
	Linear Dynamic Range	±1dB Linearity Error (Note 3)		76		dB
	Output Slope			19.9		mV/dB
	Logarithmic Intercept	(Note 5)		-87.5		dBm
	Sensitivity			-72		dBm
	Output Variation vs Temperature	Normalized to Output at 25°C $P_{IN} = -50\text{dBm}; -40^{\circ}\text{C} < T_A < 85^{\circ}\text{C}$ $P_{IN} = -30\text{dBm}; -40^{\circ}\text{C} < T_A < 85^{\circ}\text{C}$ $P_{IN} = -10\text{dBm}; -40^{\circ}\text{C} < T_A < 85^{\circ}\text{C}$	● ● ●	0.1/0.6 -0.1/0.6 -0.2/0.6		dB dB dB

ELECTRICAL CHARACTERISTICS The ● denotes the specifications which apply over the full operating temperature range, otherwise specifications are at $T_A = 25^\circ\text{C}$, $V_{CC} = 5\text{V}$, $\text{ENBL} = 5\text{V}$. (Note 2)

SYMBOL	PARAMETER	CONDITIONS	MIN	TYP	MAX	UNITS
	2nd Order Harmonic Distortion	$P_{\text{in}} = -10\text{dBm}$; At RF Input		-62		dBc
	3rd Order Harmonic Distortion	$P_{\text{in}} = -10\text{dBm}$; At RF Input		-61		dBc
$f_{\text{RF}} = 450\text{ MHz}$						
	RF Input Power Range			-75 to 10		dBm
	Linear Dynamic Range	$\pm 1\text{ dB}$ Linearity Error (Note 3)		75		dB
	Output Slope			19.6		mV/dB
	Logarithmic Intercept	(Note 5)		-87.3		dBm
	Sensitivity			-71.5		dBm
	Output Variation vs Temperature	Normalized to Output at 25°C $P_{\text{IN}} = -50\text{dBm}$; $-40^\circ\text{C} < T_A < 85^\circ\text{C}$ ● $P_{\text{IN}} = -30\text{dBm}$; $-40^\circ\text{C} < T_A < 85^\circ\text{C}$ ● $P_{\text{IN}} = -10\text{dBm}$; $-40^\circ\text{C} < T_A < 85^\circ\text{C}$ ●		0.1/0.6 0.1/0.5 -0.1/0.5		dB dB dB
	2nd Order Harmonic Distortion	$P_{\text{in}} = -10\text{dBm}$; At RF Input		-43		dBc
	3rd Order Harmonic Distortion	$P_{\text{in}} = -10\text{dBm}$; At RF Input		-44		dBc
$f_{\text{RF}} = 880\text{ MHz}$						
	RF Input Power Range			-75 to 10		dBm
	Linear Dynamic Range	$\pm 1\text{ dB}$ Linearity Error (Note 3)		75		dB
	Output Slope			19.0		mV/dB
	Logarithmic Intercept	(Note 5)		-88.8		dBm
	Sensitivity			-71.5		dBm
	Output Variation vs Temperature	Normalized to Output at 25°C $P_{\text{IN}} = -50\text{dBm}$; $-40^\circ\text{C} < T_A < 85^\circ\text{C}$ ● $P_{\text{IN}} = -30\text{dBm}$; $-40^\circ\text{C} < T_A < 85^\circ\text{C}$ ● $P_{\text{IN}} = -10\text{dBm}$; $-40^\circ\text{C} < T_A < 85^\circ\text{C}$ ●		0.1/0.7 0.1/0.4 0.1/0.4		dB dB dB
	2nd Order Harmonic Distortion	$P_{\text{in}} = -10\text{dBm}$; At RF Input		-37		dBc
	3rd Order Harmonic Distortion	$P_{\text{in}} = -10\text{dBm}$; At RF Input		-40		dBc
$f_{\text{RF}} = 2140\text{ MHz}$						
	RF Input Power Range			-72 to 10		dBm
	Linear Dynamic Range	$\pm 1\text{ dB}$ Linearity Error (Note 3)		70		dB
	Output Slope			17.7		mV/dB
	Logarithmic Intercept	(Note 5)		-89.0		dBm
	Sensitivity			-69.0		dBm
	Output Variation vs Temperature	Normalized to Output at 25°C $P_{\text{IN}} = -50\text{dBm}$; $-40^\circ\text{C} < T_A < 85^\circ\text{C}$ ● $P_{\text{IN}} = -30\text{dBm}$; $-40^\circ\text{C} < T_A < 85^\circ\text{C}$ ● $P_{\text{IN}} = -10\text{dBm}$; $-40^\circ\text{C} < T_A < 85^\circ\text{C}$ ●		0.3/0.4 0.4/0.1 0.7/0.5		dB dB dB
$f_{\text{RF}} = 2700\text{ MHz}$						
	RF Input Power Range			-72 to 10		dBm
	Linear Dynamic Range	$\pm 1\text{ dB}$ Linearity Error (Note 3)		65		dB
	Output Slope			17.6		mV/dB
	Logarithmic Intercept	(Note 5)		-87.5		dBm

ELECTRICAL CHARACTERISTICS

The ● denotes the specifications which apply over the full operating temperature range, otherwise specifications are at $T_A = 25^\circ\text{C}$, $V_{CC} = 5\text{V}$, $\text{ENBL} = 5\text{V}$. (Note 2)

SYMBOL	PARAMETER	CONDITIONS	MIN	TYP	MAX	UNITS
	Sensitivity			-69.5		dBm
	Output Variation vs Temperature	Normalized to Output at 25°C $P_{IN} = -50\text{dBm}; -40^\circ\text{C} < T_A < 85^\circ\text{C}$ $P_{IN} = -30\text{dBm}; -40^\circ\text{C} < T_A < 85^\circ\text{C}$ $P_{IN} = -10\text{dBm}; -40^\circ\text{C} < T_A < 85^\circ\text{C}$	● ● ●	0.3/0.3 0.7/-0.3 1.1/-0.9		dB dB dB

$f_{RF} = 3600\text{ MHz}$

	RF Input Power Range			-65 to 10		dBm
	Linear Dynamic Range	$\pm 1\text{ dB}$ Linearity Error (Note 3)		57		dB
	Output Slope			18		mV/dB
	Logarithmic Intercept	(Note 5)		-81.4		dBm
	Sensitivity			-63		dBm
	Output Variation vs Temperature	Normalized to Output at 25°C $P_{IN} = -45\text{dBm}; -40^\circ\text{C} < T_A < 85^\circ\text{C}$ $P_{IN} = -25\text{dBm}; -40^\circ\text{C} < T_A < 85^\circ\text{C}$ $P_{IN} = -5\text{dBm}; -40^\circ\text{C} < T_A < 85^\circ\text{C}$	● ● ●	0.6/-0.3 0.9/-0.6 1.4/-1.2		dB dB dB

Output Interface

	Output DC Voltage	No RF Signal Present		0.350		V
	Output Impedance			150		Ω
	Source Current			10		mA
	Sink Current			200		μA
	Rise Time	0.5V to 1.6V, 10% to 90%, $f_{RF} = 880\text{ MHz}$		100		ns
	Fall Time	1.6V to 0.5V, 10% to 90%, $f_{RF} = 880\text{ MHz}$		180		ns

Power Up/Down

	ENBL = High (On)		●	1		V
	ENBL = Low (Off)		●		0.3	V
	ENBL Input Current	$V_{ENBL} = 5\text{V}$		205		μA
	Turn ON time			300		ns
	Turn OFF Time			1		μs

Power Supply

	Supply Voltage			3	5.25	V
	Supply Current			29	36	mA
	Shutdown Current	ENBL = Low		1	100	μA

Note 1: Stresses beyond those listed under Absolute Maximum Ratings may cause permanent damage to the device. Exposure to any Absolute Maximum Rating condition for extended periods may affect device reliability and lifetime.

Note 2: Specifications over the -40°C to 85°C temperature range are assured by design, characterization and correlation with statistical process control.

Note 3: The linearity error is calculated by the difference between the incremental slope of the output and the average slope from -50dBm

to -20dBm . The dynamic range is defined as the range over which the linearity error is within $\pm 1\text{dB}$.

Note 4: Sensitivity is defined as the minimum input power required for the linearity error within 3dB of the ideal log-linear transfer curve.

Note 5: Logarithmic Intercept is an extrapolated input power level from the best-fitted log-linear straight line, where the output voltage is 0V.

TYPICAL PERFORMANCE CHARACTERISTICS (Test Circuit shown in Figure 5)

Supply Current vs Supply Voltage

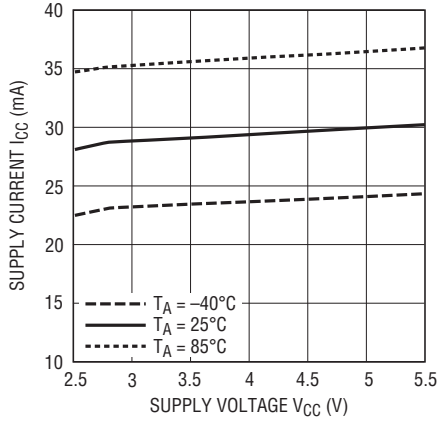

Output Voltage, Linearity Error vs Input Power at 40MHz

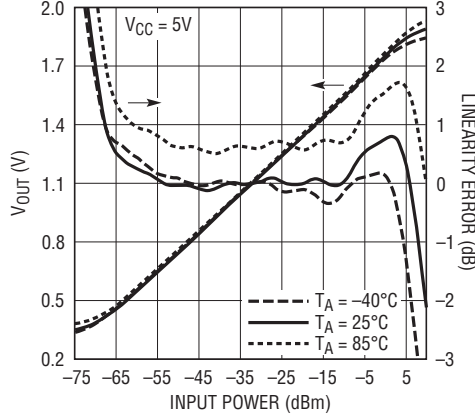

VOUT Variation vs Input Power at 40MHz

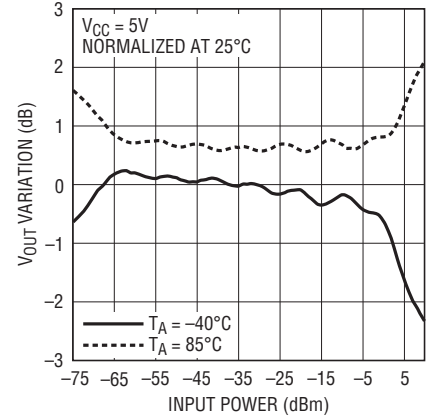

Output Voltage, Linearity Error vs Input Power at 450MHz

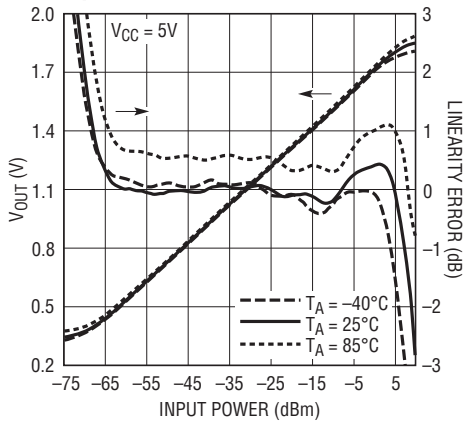

VOUT Variation vs Input Power at 450MHz

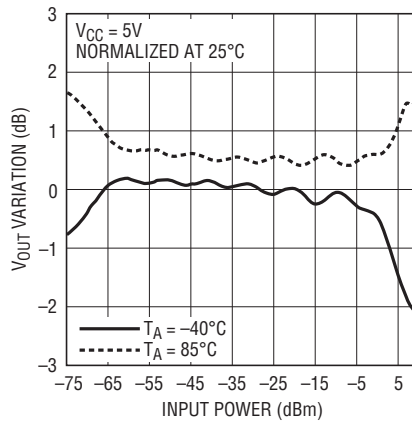

Output Voltage, Linearity Error vs Input Power at 880MHz

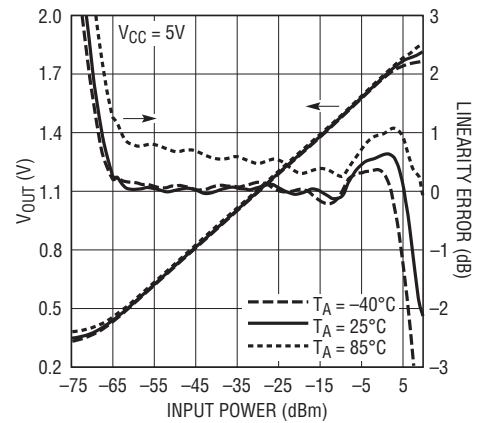

VOUT Variation vs Input Power at 880MHz

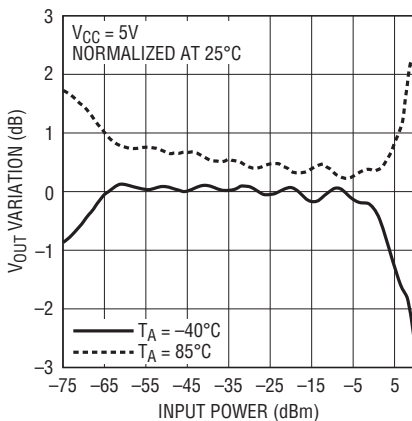

Output Voltage, Linearity Error vs Input Power at 2.14GHz

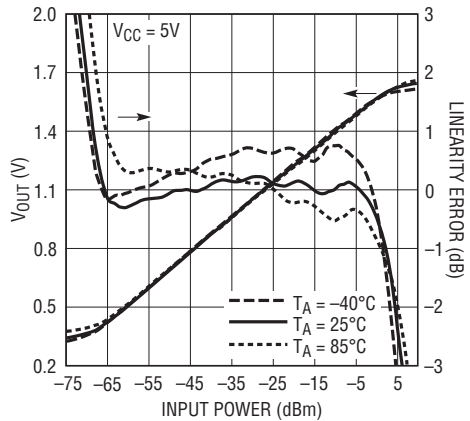

VOUT Variation vs Input Power at 2.14GHz

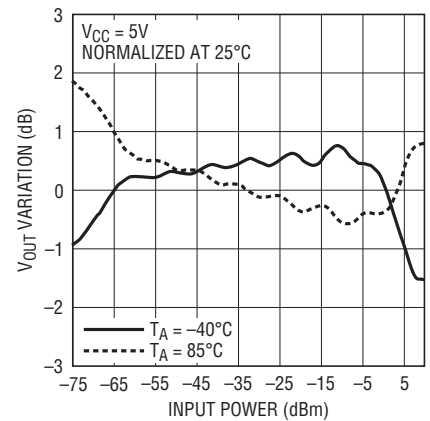

TYPICAL PERFORMANCE CHARACTERISTICS (Test Circuit shown in Figure 5)

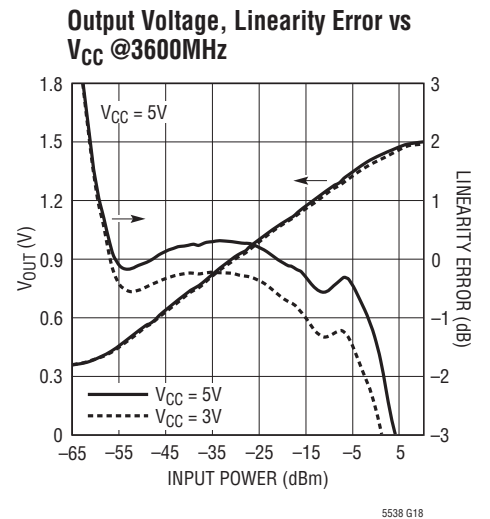
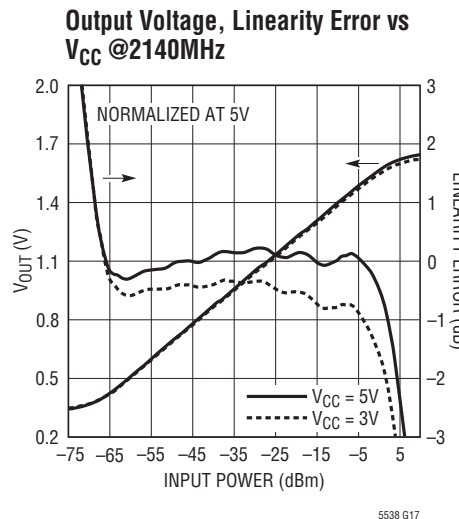
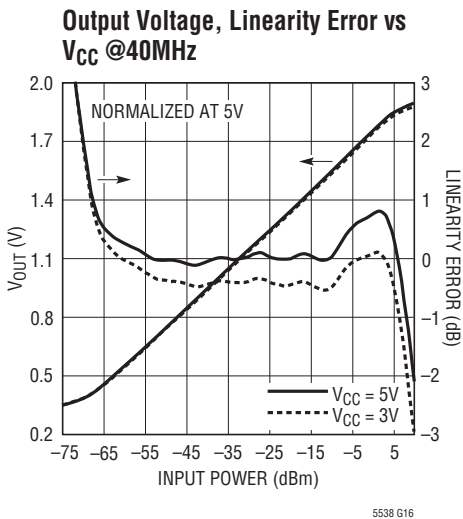
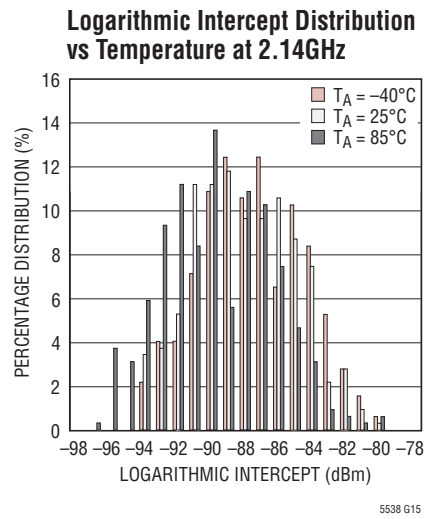
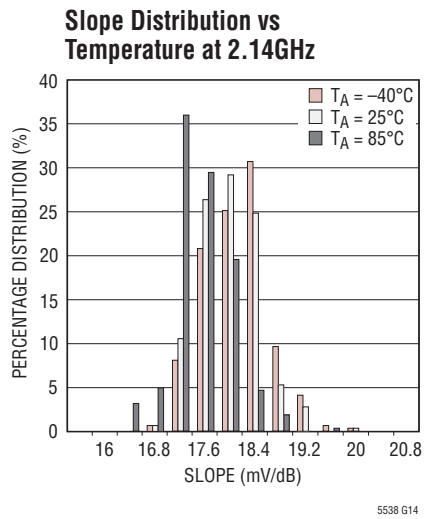
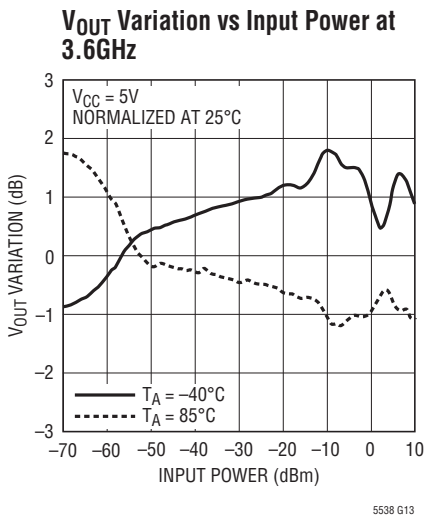
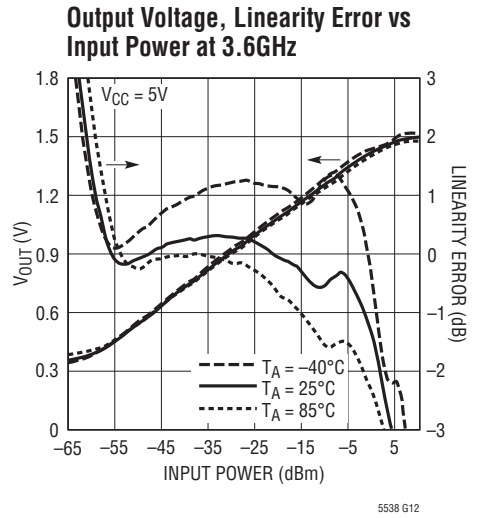
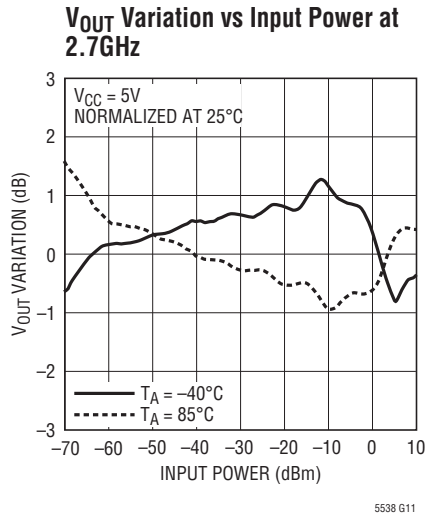
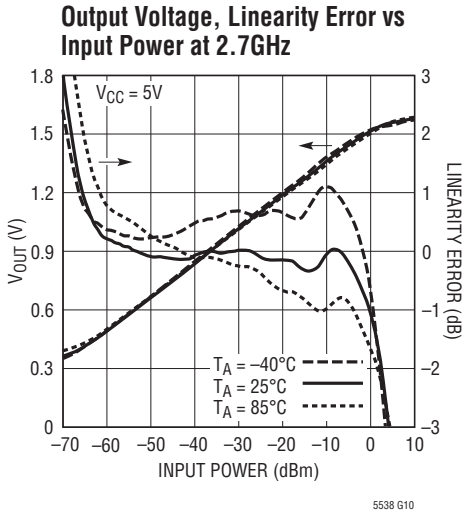

PIN FUNCTIONS

ENBL (Pin 1): Enable Pin. An applied voltage above 1V will activate the bias for the IC. For an applied voltage below 0.3V, the circuits will be shut down (disabled) with a corresponding reduction in power supply current. If the enable function is not required, then this pin can be connected to V_{CC} . Typical enable pin input currents are 100 μ A for EN = 3V and 200 μ A for EN = 5V, respectively. Note that at no time should the ENBL pin voltage be allowed to exceed V_{CC} by more than 0.3V.

IN⁺ (Pin 2): RF Input Pin. The pin is internally biased to $V_{CC} - 0.5V$ and should be DC blocked externally. The input is connected via internal 394 Ω resistor to the IN⁻ pin which should be connected to ground with an ac-decoupling capacitor.

IN⁻ (Pin 3): AC Ground Pin. The pin is internally biased to $V_{CC} - 0.5V$ and coupled to ground via internal 20pF capacitor.

This pin should be connected to ground with an external ac-decoupling capacitor for low frequency operation.

GND (Pin 4, Exposed Pad Pin 9): Circuit Ground Return for the entire IC. This pin must be soldered to the printed circuit board ground plane.

V_{CC} (Pin 5): Power Supply Pin. This pin should be decoupled using 100pF and 0.1 μ F capacitors.

CAP⁻, CAP⁺ (Pins 6, 7): Optional Filter Capacitor Pins. These pins are internally connected to the detector outputs in front of the output buffer amplifier. An external low-pass filtering can be formed by connecting a capacitor to V_{CC} from each pin for filtering a low frequency modulation signal. See the Applications Information section for detail.

OUT (Pin 8): Detector DC Output Pin.

BLOCK DIAGRAM

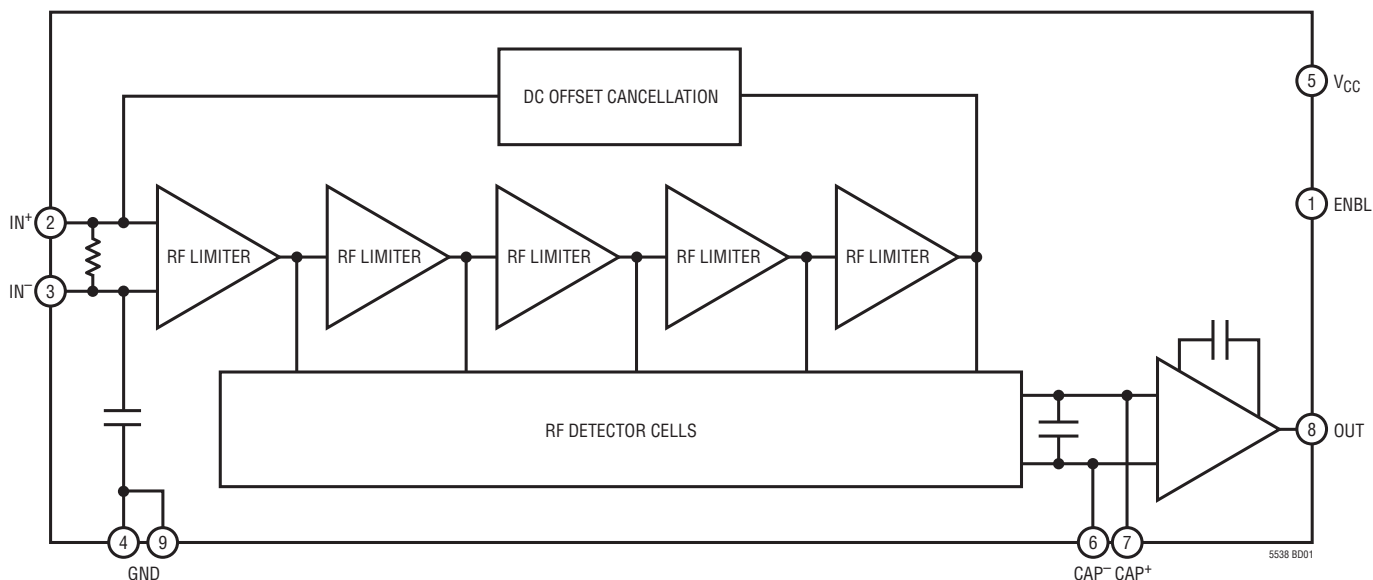

APPLICATIONS INFORMATION

The LT5538 is a 40MHz to 3.8 GHz logarithmic RF power detector. It consists of cascaded limiting amplifiers and RF detectors. The output currents from every RF detector are combined and low-pass filtered before applied to the output buffer amplifier. As a result, the final DC output voltage approximates the logarithm of the amplitude of the input signal. The LT5538 is able to accurately measure an RF signal over a 70dB dynamic range (–68dBm to 2dBm at 2.1GHz) with 50Ω single-ended input impedance. The slope of linear to log transfer function is about 17.7mV/dB at 2.1GHz. Within the linear dynamic range, very stable output is achieved over the full temperature range from –40°C to 85°C and over the full operating frequency range from 40MHz to 3.8GHz. The absolute variation over temperature is typically within ±1dB over 65dB dynamic range at 2.1GHz.

RF INPUT

The simplified schematic of the input circuit is shown in Figure 1. The IN⁺ and IN[–] pins are internally biased to V_{CC} –0.5V. The IN[–] pin is internally coupled to ground via 20pF capacitor. An external capacitor of 1nF is needed to connect this pin to ground for low frequency operation. The impedance between IN⁺ and IN[–] is about 394Ω. The RF input pin IN⁺ should be DC blocked when connected to ground or other matching components. A 56Ω resistor (R1) connected to ground will provide better than 10dB input return loss over the operating frequency range up to 1.5GHz. At higher operating frequency, additional LC

matching elements are needed for a proper impedance matching to a 50Ω source as shown in Figure 2. Refer to Figure 6 for the circuit schematic of the input matching network. The input impedance vs frequency of the RF input port IN⁺ is detailed in Table 1.

Table 1. RF Input Impedance

FREQUENCY (MHz)	RF INPUT IMPEDANCE (Ω)	S11	
		MAG	ANGLE(°)
40	47.3 + j129.7	0.800	38.5
100	246.6 + j210.7	0.790	11.5
200	408.7 – j37.8	0.785	–1.5
400	192.9 – j190.9	0.772	–14.9
600	105.6 – j158.4	0.756	–25.3
800	69.3 – j127.4	0.737	–34.4
1000	51.8 – j106.2	0.720	–42.7
1200	41.5 – j90.9	0.707	–50.6
1400	34.2 – j78.7	0.697	–58.2
1600	29.2 – j60.0	0.687	–65.6
1800	25.4 – j60.7	0.678	–73.1
2000	22.6 – j53.8	0.669	–80.4
2200	20.5 – j47.7	0.659	–87.7
2400	18.9 – j42.4	0.649	–94.6
2600	17.9 – j37.6	0.638	–101.5
2800	17.1 – j33.4	0.627	–108.2
3000	16.4 – j29.5	0.615	–114.7
3200	16.1 – j26.0	0.602	–121.0
3400	15.9 – j22.8	0.589	–127.0
3600	15.9 – j20.0	0.574	–132.8
3800	15.9 – j17.5	0.560	–137.9

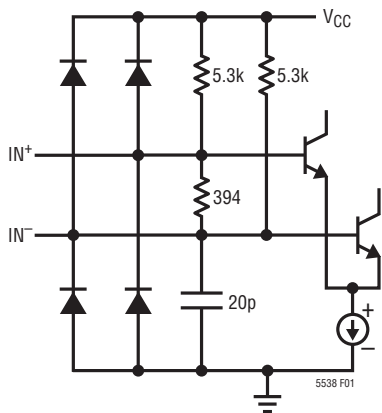

Figure 1. Simplified Schematic of the Input Circuit

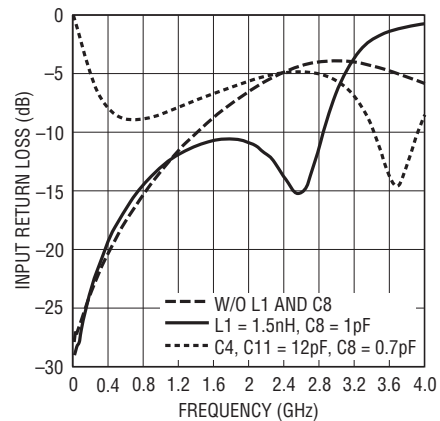

Figure 2. Input Return Loss with Additional LC Matching Network

APPLICATIONS INFORMATION

OUTPUT INTERFACE

The output interface of the LT5538 is shown in Figure 3. This output buffer circuit can source 10mA current to the load and sink 200 μ A current from the load. The small-signal output bandwidth is approximately 4MHz when the output is resistively terminated or open. The full-scaled 10% to 90% rise and fall times are 100nS and 180nS, respectively. The output transient responses at varied input power levels are shown in Figure 4.

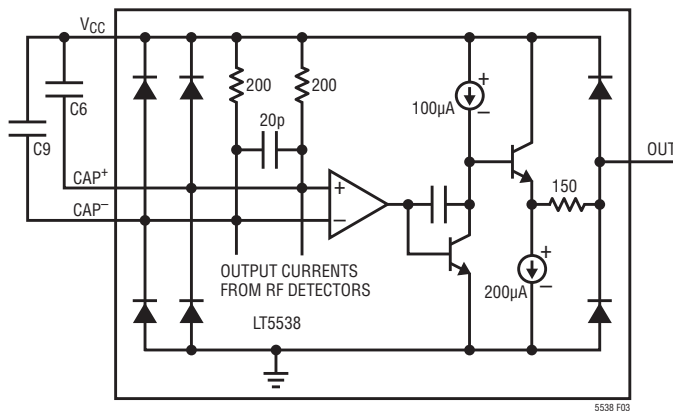

Figure 3. Simplified Schematic of the Output Interface

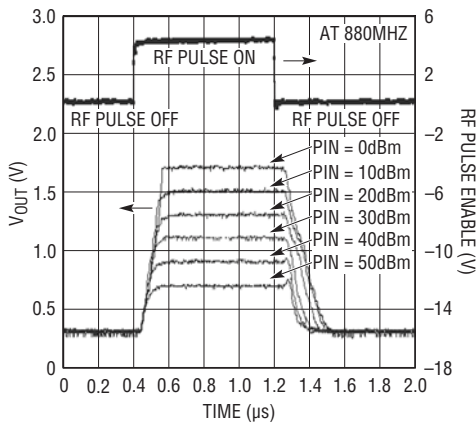

Figure 4. Simplified Circuit Schematic of the Output Interface

When the part is enabled, the output impedance is about 150 Ω . When it is disabled, the output impedance is about 29.5k Ω referenced to ground.

EXTERNAL FILTERING AT CAP+, CAP-

The CAP+ and CAP- Pins are internally biased at $V_{CC} - 0.36V$ via a 200 Ω resistor from voltage supply V_{CC} as shown in Figure 3. These two pins are connected to the differential outputs of the internal RF detector cells. In combination with the 20pF in parallel, a low-pass filter is formed with $-3dB$ corner frequency of 20MHz. The high frequency rectified signals (particularly second-order harmonic of the RF signal) from the detector cells are filtered and then the DC output is amplified by the output buffer amplifier. In some applications, the LT5538 may be used to measure a modulated RF signal with low frequency AM content (lower than 20MHz), a large modulation signal may be present at these two pins due to insufficient low-pass filtering, resulting in output voltage fluctuation at the LT5538's output. Its DC content may also vary depending upon the modulation frequency. To assure stable DC output of the LT5538, external capacitors C6 and C9 can be connected from CAP+ and CAP- to V_{CC} to filter out this low frequency AM modulation signal. Assume the modulation frequency of the RF signal is f_{MOD} , the capacitor value in Farads of C6 and C9 can be chosen by the following formula:

$$C6 \text{ (or } C9) \geq 10 / (2\pi \cdot 200 \cdot f_{MOD})$$

Do not connect these two filtering capacitors to ground or any other low voltage reference at any time to avoid an abnormal start-up condition.

APPLICATIONS INFORMATION

ENBL (ENABLE) PIN OPERATION

A simplified circuit schematic of the ENBL Pin is shown in Figure 5. The enable voltage necessary to turn on the LT5538 is 1V. The current drawn by the ENBL pin varies with the voltage applied at the pin. When the ENBL voltage is 3V, the ENBL current is typically 100 μ A. When the ENBL voltage is 5V, the ENBL current is increased to 200

μ A. To disable or turn off the chip, this voltage should be below 0.3V. It is important that the voltage applied to the ENBL pin should never exceed V_{CC} by more than 0.3V. Otherwise, the supply current may be sourced through the upper ESD protection diode connected at the ENBL pin. Under no circumstances should voltage be applied to the ENBL Pin before the supply voltage is applied to the V_{CC} pin. If this occurs, damage to the IC may result.

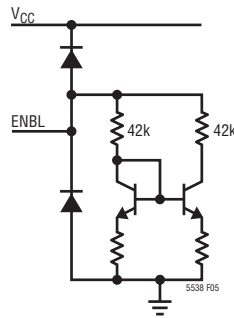

Figure 5. Simplified Schematic of the Enable Circuit

TEST CIRCUIT

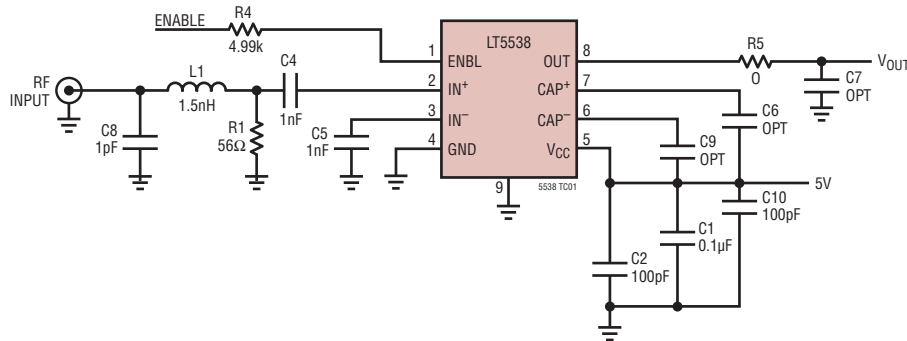

Figure 6. Evaluation Board Circuit Schematic

40MHz to 2.7GHz

REF DES	VALUE	SIZE	PART NUMBER
C1	0.1 μ F	0603	AVX 0603ZC104KAT
C2, C10	100pF	0402	AVX 0402YC101KAT
C4, C5	1nF	0603	AVX 0402ZC102K
C8	1pF	0402	AVX 0402YA1ROCAT
R1	56	0402	VISHAY, CRCW040256ROFKED
R4	4.99k	0402	VISHAY, CRCW04024K99FKED
L1	1.5nH	0402	TOKO, LL1005-FH2IN5S

3.6GHz to 3.8GHz

REF DES	VALUE	SIZE	PART NUMBER
C4, C11	12pF	0402	MURATA, GRM155C1H120JZ01B
C8	0.7pF	0402	MURATA, GJR155C1HR70BB01
C5	OPEN		

NOTE: Replace L₁ with C₁₁.

RELATED PARTS

PART NUMBER	DESCRIPTION	COMMENTS
Infrastructure		
LT5514	Ultralow Distortion, IF Amplifier/ADC Driver with Digitally Controlled Gain	850MHz Bandwidth, 47 dBm OIP3 at 100MHz, 10.5dB to 33dB Gain Control Range
LT5515	1.5GHz to 2.5GHz Direct Conversion Quadrature Demodulator	20dBm IIP3, Integrated LO Quadrature Generator
LT5516	0.8GHz to 1.5GHz Direct Conversion Quadrature Demodulator	21.5dBm IIP3, Integrated LO Quadrature Generator
LT5517	40MHz to 900MHz Quadrature Demodulator	21dBm IIP3, Integrated LO Quadrature Generator
LT5518	1.5GHz to 2.4GHz High Linearity Direct Quadrature Modulator	22.8dBm OIP3 at 2GHz, -158.2dBm/Hz Noise Floor, 50Ω Single-Ended RF and LO Ports, 4-Channel W-CDMA ACPR = -64dBc at 2.14GHz
LT5519	0.7GHz to 1.4GHz High Linearity Upconverting Mixer	17.1dBm IIP3 at 1GHz, Integrated RF Output Transformer with 50Ω Matching, Single-Ended LO and RF Ports Operation
LT5520	1.3GHz to 2.3GHz High Linearity Upconverting Mixer	15.9dBm IIP3 at 1.9GHz, Integrated RF Output Transformer with 50Ω Matching, Single-Ended LO and RF Ports Operation
LT5521	10MHz to 3700MHz High Linearity Upconverting Mixer	24.2dBm IIP3 at 1.95GHz, NF = 12.5dB, 3.15V to 5.25V Supply, Single-Ended LO Port Operation
LT5522	600 MHz to 2.7GHz High Signal Level Downconverting Mixer	4.5V to 5.25V Supply, 25dBm IIP3 at 900MHz, NF = 12.5dB, 50Ω Single-Ended RF and LO Ports
LT5524	Low Power, Low Distortion ADC Driver with Digitally Programmable Gain	450MHz Bandwidth, 40dBm OIP3, 4.5dB to 27dB Gain Control
LT5525	High Linearity, Low Power Downconverting Mixer	Single-Ended 50Ω RF and LO Ports, 17.6dBm IIP3 at 1900MHz, I _{CC} = 28mA
LT5526	High Linearity, Low Power Downconverting Mixer	3V to 5.3V Supply, 16.5dBm IIP3, 100kHz to 2GHz RF, NF = 11dB, I _{CC} = 28mA, -65dBm LO-RF Leakage
LT5527	400MHz to 3.7GHz High Signal Level Downconverting Mixer	IIP3 = 23.5dBm and NF = 12.5dBm at 1900MHz, 4.5V to 5.25V Supply, I _{CC} = 78mA, Conversion Gain = 2dB
LT5528	1.5GHz to 2.4GHz High Linearity Direct Quadrature Modulator	21.8dBm OIP3 at 2GHz, -159.3dBm/Hz Noise Floor, 50Ω, 0.5V _{DC} Baseband Interface, 4-Channel W-CDMA ACPR = -66dBc at 2.14GHz
LT5557	400MHz to 3.8GHz, 3.3V High Signal Level Downconverting Mixer	IIP3 = 23.7dBm at 2600MHz, 23.5dBm at 3600MHz, I _{CC} = 82mA at 3.3V
LT5560	Ultra-Low Power Active Mixer	10mA Supply Current, 10dBm IIP3, 10dB NF, Usable as Up- or Down-Converter.
LT5568	700MHz to 1050MHz High Linearity Direct Quadrature Modulator	22.9dBm OIP3 at 850MHz, -160.3dBm/Hz Noise Floor, 50Ω, 0.5V _{DC} Baseband Interface, 3-Ch CDMA2000 ACPR = -71.4dBc at 850MHz
LT5572	1.5GHz to 2.5GHz High Linearity Direct Quadrature Modulator	21.6dBm OIP3 at 2GHz, -158.6dBm/Hz Noise Floor, High-Ohmic 0.5V _{DC} Baseband Interface, 4-Ch W-CDMA ACPR = -67.7dBc at 2.14GHz
LT5575	800MHz to 2.7GHz High Linearity Direct Conversion I/Q Demodulator	50Ω, Single-Ended RF and LO Inputs. 28dBm IIP3 at 900MHz, 13.2dBm P1dB, 0.04dB I/Q Gain Mismatch, 0.4° I/Q Phase Mismatch
RF Power Detectors		
LTC®5505	RF Power Detectors with >40dB Dynamic Range	300MHz to 3GHz, Temperature Compensated, 2.7V to 6V Supply
LTC5507	100kHz to 1000MHz RF Power Detector	100kHz to 1GHz, Temperature Compensated, 2.7 to 6V Supply
LTC5508	300MHz to 7GHz RF Power Detector	44dB Dynamic Range, Temperature Compensated, SC70 Package
LTC5509	300MHz to 3GHz RF Power Detector	36dB Dynamic Range, Low Power Consumption, SC70 Package
LTC5530	300MHz to 7GHz Precision RF Power Detector	Precision V _{OUT} Offset Control, Shutdown, Adjustable Gain
LTC5531	300MHz to 7GHz Precision RF Power Detector	Precision V _{OUT} Offset Control, Shutdown, Adjustable Offset
LTC5532	300MHz to 7GHz Precision RF Power Detector	Precision V _{OUT} Offset Control, Adjustable Gain and Offset
LT5534	50MHz to 3GHz Log RF Power Detector with 60dB Dynamic Range	±1dB Output Variation over Temperature, 38ns Response Time, Log Linear Response
LTC5536	Precision 600MHz to 7GHz RF Power Detector with Fast Comparator Output	25ns Response Time, Comparator Reference Input, Latch Enable Input, -26dBm to +12dBm Input Range
LT5537	Wide Dynamic Range Log RF/IF Detector	Low Frequency to 1GHz, 83dB Log Linear Dynamic Range
LT5570	2.7GHz RMS Power Detector	Fast Responding, up to 60dB Dynamic Range, ±0.3dB Accuracy Over Temperature and Dynamic Range

5538f