

Distributed by:

JAMECO[®]
ELECTRONICS

www.Jameco.com ♦ 1-800-831-4242

The content and copyrights of the attached
material are the property of its owner.

Jameco Part Number 1745119

Single/Dual/Quad 100MHz,
 Rail-to-Rail Input and Output,
 Ultralow $1.9\text{nV}/\sqrt{\text{Hz}}$ Noise, Low Power Op Amps

FEATURES

- Low Noise Voltage: $1.9\text{nV}/\sqrt{\text{Hz}}$ (100kHz)
- Low Supply Current: 3mA/Amp Max
- Gain Bandwidth Product: 100MHz
- Dual LT6203 in Tiny DFN Package
- Low Distortion: -80dB at 1MHz
- Low Offset Voltage: 500 μV Max
- Wide Supply Range: 2.5V to 12.6V
- Input Common Mode Range Includes Both Rails
- Output Swings Rail-to-Rail
- Common Mode Rejection Ratio 90dB Typ
- Unity Gain Stable
- Low Noise Current: $1.1\text{pA}/\sqrt{\text{Hz}}$
- Output Current: 30mA Min
- Operating Temperature Range -40°C to 85°C

APPLICATIONS

- Low Noise, Low Power Signal Processing
- Active Filters
- Rail-to-Rail Buffer Amplifiers
- Driving A/D Converters
- DSL Receivers
- Battery Powered/Battery Backed Equipment

DESCRIPTION

The LT[®]6202/LT6203/LT6204 are single/dual/quad low noise, rail-to-rail input and output unity gain stable op amps that feature $1.9\text{nV}/\sqrt{\text{Hz}}$ noise voltage and draw only 2.5mA of supply current per amplifier. These amplifiers combine very low noise and supply current with a 100MHz gain bandwidth product, a 25V/ μs slew rate, and are optimized for low supply signal conditioning systems.

These amplifiers maintain their performance for supplies from 2.5V to 12.6V and are specified at 3V, 5V and $\pm 5\text{V}$ supplies. Harmonic distortion is less than -80dBc at 1MHz making these amplifiers suitable in low power data acquisition systems.

The LT6202 is available in the 5-pin SOT-23 and the 8-pin SO, while the LT6203 comes in 8-pin SO and MSOP packages with standard op amp pinouts. For compact layouts the LT6203 is also available in a tiny fine line leadless package (DFN), while the quad LT6204 is available in the 16-pin SSOP and 14-pin SO packages. These devices can be used as plug-in replacements for many op amps to improve input/output range and noise performance.

LT, LTC and LT are registered trademarks of Linear Technology Corporation.

TYPICAL APPLICATION

Low Noise 4- to 2-Wire Local Echo Cancellation Differential Receiver

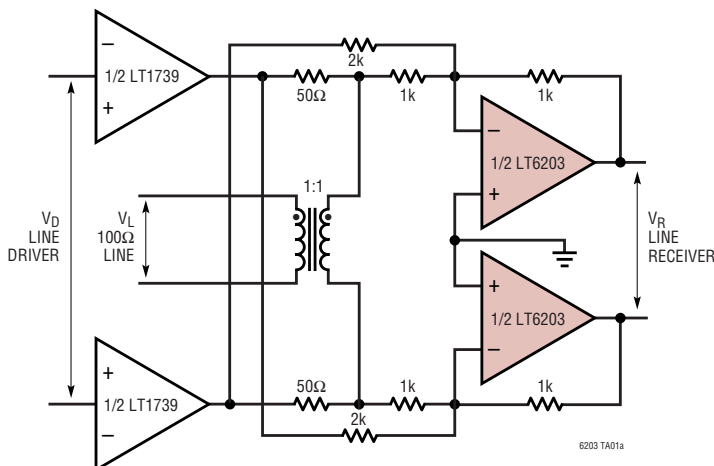

Line Receiver Integrated Noise 25kHz to 150kHz

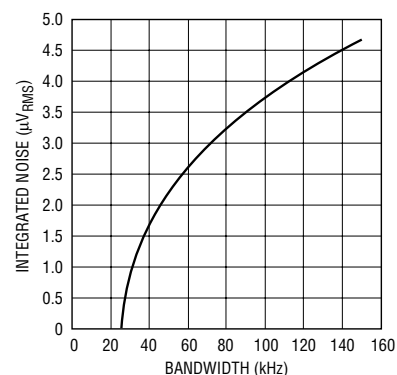

LT6202/LT6203/LT6204

ABSOLUTE MAXIMUM RATINGS (Note 1)

Total Supply Voltage (V^+ to V^-) 12.6V
 Input Current (Note 2) $\pm 40\text{mA}$
 Output Short-Circuit Duration (Note 3) Indefinite
 Operating Temperature Range (Note 4) ... -40°C to 85°C
 Specified Temperature Range (Note 5) -40°C to 85°C
 Junction Temperature 150°C

Junction Temperature (DD Package) 125°C
 Storage Temperature Range -65°C to 150°C
 Storage Temperature Range
 (DD Package) -65°C to 125°C
 Lead Temperature (Soldering, 10 sec) 300°C

PACKAGE/ORDER INFORMATION

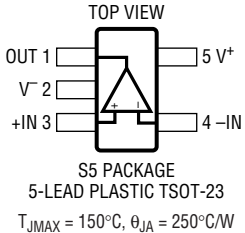
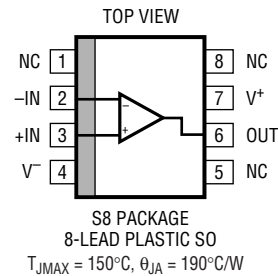
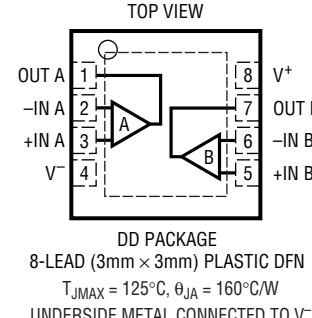
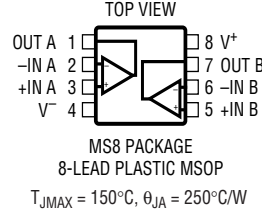
 <p>TOP VIEW OUT 1 5 V^+ V^- 2 +IN 3 4 -IN S5 PACKAGE 5-LEAD PLASTIC TSOT-23 $T_{JMAX} = 150^\circ\text{C}$, $\theta_{JA} = 250^\circ\text{C/W}$</p>		 <p>TOP VIEW NC 1 8 NC -IN 2 7 V^+ +IN 3 6 OUT V^- 4 5 NC S8 PACKAGE 8-LEAD PLASTIC SO $T_{JMAX} = 150^\circ\text{C}$, $\theta_{JA} = 190^\circ\text{C/W}$</p>			
ORDER PART NUMBER	S5 PART MARKING*	ORDER PART NUMBER	S8 PART MARKING		
LT6202CS5 LT6202IS5	LTG6	LT6202CS8 LT6202IS8	6202 6202I		
 <p>TOP VIEW OUT A 1 8 V^+ -IN A 2 7 OUT B +IN A 3 6 -IN B V^- 4 5 +IN B DD PACKAGE 8-LEAD (3mm \times 3mm) PLASTIC DFN $T_{JMAX} = 125^\circ\text{C}$, $\theta_{JA} = 160^\circ\text{C/W}$ UNDERSIDE METAL CONNECTED TO V^-</p>		 <p>TOP VIEW OUT A 1 8 V^+ -IN A 2 7 OUT B +IN A 3 6 -IN B V^- 4 5 +IN B MS8 PACKAGE 8-LEAD PLASTIC MSOP $T_{JMAX} = 150^\circ\text{C}$, $\theta_{JA} = 250^\circ\text{C/W}$</p>			
ORDER PART NUMBER	DD PART MARKING*	ORDER PART NUMBER	MS8 PART MARKING	ORDER PART NUMBER	S8 PART MARKING
LT6203CDD LT6203IDD	LAAP	LT6203CMS8 LT6203IMS8	LTB2 LTB3	LT6203CS8 LT6203IS8	6203 6203I

*The temperature grades are identified by a label on the shipping container.

PACKAGE/ORDER INFORMATION

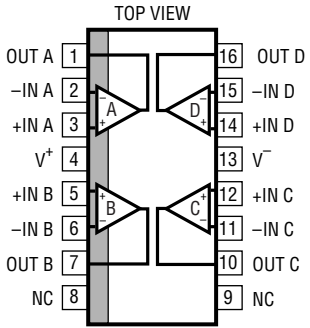
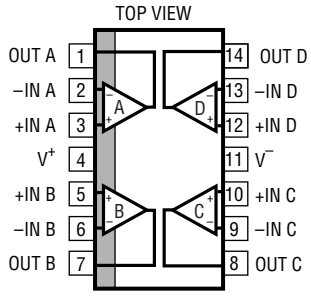
 <p>GN PACKAGE 16-LEAD NARROW PLASTIC SSOP $T_{JMAX} = 150^{\circ}C, \theta_{JA} = 135^{\circ}C/W$</p>	ORDER PART NUMBER	 <p>S PACKAGE 14-LEAD PLASTIC SO $T_{JMAX} = 150^{\circ}C, \theta_{JA} = 150^{\circ}C/W$</p>	ORDER PART NUMBER
	LT6204CGN LT6204IGN		LT6204CS LT6204IS
	GN PART MARKING		
	6204 6204I		

Consult LTC Marketing for parts specified with wider operating temperature ranges.

ELECTRICAL CHARACTERISTICS $T_A = 25^{\circ}C, V_S = 5V, 0V; V_S = 3V, 0V; V_{CM} = V_{OUT} = \text{half supply, unless otherwise noted.}$

SYMBOL	PARAMETER	CONDITIONS	MIN	TYP	MAX	UNITS
V_{OS}	Input Offset Voltage	$V_S = 5V, 0V, V_{CM} = \text{Half Supply}$ LT6203, LT6204, LT6202S8 LT6202 SOT-23		0.1	0.5	mV
				0.1	0.7	mV
		$V_S = 3V, 0V, V_{CM} = \text{Half Supply}$ LT6203, LT6204, LT6202S8 LT6202 SOT-23		0.6	1.5	mV
				0.6	1.7	mV
	Input Offset Voltage Match (Channel-to-Channel) (Note 6)	$V_S = 5V, 0V, V_{CM} = V^+ \text{ to } V^-$ LT6203, LT6204, LT6202S8 LT6202 SOT-23		0.25	2.0	mV
				0.25	2.2	mV
		$V_S = 3V, 0V, V_{CM} = V^+ \text{ to } V^-$ LT6203, LT6204, LT6202S8 LT6202 SOT-23		1.0	3.5	mV
				1.0	3.7	mV
I_B	Input Bias Current	$V_{CM} = \text{Half Supply}$	-7.0	-1.3		μA
		$V_{CM} = V^+$		1.3	2.5	μA
		$V_{CM} = V^-$	-8.8	-3.3		μA
ΔI_B	I_B Shift	$V_{CM} = V^- \text{ to } V^+$		4.7	11.3	μA
	I_B Match (Channel-to-Channel) (Note 6)			0.1	0.6	μA
I_{OS}	Input Offset Current	$V_{CM} = \text{Half Supply}$		0.12	1	μA
		$V_{CM} = V^+$		0.07	1	μA
		$V_{CM} = V^-$		0.12	1.1	μA
	Input Noise Voltage	0.1Hz to 10Hz		800		nV _{p-p}
e_n	Input Noise Voltage Density	$f = 100kHz, V_S = 5V$		2		nV/ \sqrt{Hz}
		$f = 10kHz, V_S = 5V$		2.9	4.5	nV/ \sqrt{Hz}
i_n	Input Noise Current Density, Balanced Input Noise Current Density, Unbalanced	$f = 10kHz, V_S = 5V$		0.75		pA/ \sqrt{Hz}
				1.1		pA/ \sqrt{Hz}
	Input Resistance	Common Mode		4		M Ω
		Differential Mode		12		k Ω

620234fa

LT6202/LT6203/LT6204

ELECTRICAL CHARACTERISTICS

$T_A = 25^\circ\text{C}$, $V_S = 5\text{V}, 0\text{V}$; $V_S = 3\text{V}, 0\text{V}$; $V_{CM} = V_{OUT} = \text{half supply}$, unless otherwise noted.

SYMBOL	PARAMETER	CONDITIONS	MIN	TYP	MAX	UNITS
C_{IN}	Input Capacitance	Common Mode		1.8		pF
		Differential Mode		1.5		pF
A_{VOL}	Large Signal Gain	$V_S = 5\text{V}, V_O = 0.5\text{V to } 4.5\text{V}, R_L = 1\text{k to } V_S/2$	40	70		V/mV
		$V_S = 5\text{V}, V_O = 1\text{V to } 4\text{V}, R_L = 100\text{ to } V_S/2$	8.0	14		V/mV
		$V_S = 3\text{V}, V_O = 0.5\text{V to } 2.5\text{V}, R_L = 1\text{k to } V_S/2$	17	40		V/mV
CMRR	Common Mode Rejection Ratio	$V_S = 5\text{V}, V_{CM} = V^- \text{ to } V^+$	60	83		dB
		$V_S = 5\text{V}, V_{CM} = 1.5\text{V to } 3.5\text{V}$	80	100		dB
		$V_S = 3\text{V}, V_{CM} = V^- \text{ to } V^+$	56	80		dB
	CMRR Match (Channel-to-Channel) (Note 6)	$V_S = 5\text{V}, V_{CM} = 1.5\text{V to } 3.5\text{V}$	85	120		dB
PSRR	Power Supply Rejection Ratio	$V_S = 2.5\text{V to } 10\text{V}, V_{CM} = 0\text{V}$	60	74		dB
	PSRR Match (Channel-to-Channel) (Note 6)	$V_S = 2.5\text{V to } 10\text{V}, V_{CM} = 0\text{V}$	70	100		dB
	Minimum Supply Voltage (Note 7)		2.5			V
V_{OL}	Output Voltage Swing LOW Saturation (Note 8)	No Load		5	50	mV
		$I_{SINK} = 5\text{mA}$		85	190	mV
		$V_S = 5\text{V}, I_{SINK} = 20\text{mA}$		240	460	mV
		$V_S = 3\text{V}, I_{SINK} = 15\text{mA}$		185	350	mV
V_{OH}	Output Voltage Swing HIGH Saturation (Note 8)	No Load		25	75	mV
		$I_{SOURCE} = 5\text{mA}$		90	210	mV
		$V_S = 5\text{V}, I_{SOURCE} = 20\text{mA}$		325	600	mV
		$V_S = 3\text{V}, I_{SOURCE} = 15\text{mA}$		225	410	mV
I_{SC}	Short-Circuit Current	$V_S = 5\text{V}$	± 30	± 45		mA
		$V_S = 3\text{V}$	± 25	± 40		mA
I_S	Supply Current per Amp	$V_S = 5\text{V}$		2.5	3.0	mA
		$V_S = 3\text{V}$		2.3	2.85	mA
GBW	Gain Bandwidth Product	Frequency = 1MHz, $V_S = 5\text{V}$		90		MHz
SR	Slew Rate	$V_S = 5\text{V}, A_V = -1, R_L = 1\text{k}, V_O = 4\text{V}$	17	24		V/ μs
FPBW	Full Power Bandwidth (Note 10)	$V_S = 5\text{V}, V_{OUT} = 3V_{P-P}$	1.8	2.5		MHz
t_S	Settling Time	0.1%, $V_S = 5\text{V}, V_{STEP} = 2\text{V}, A_V = -1, R_L = 1\text{k}$		85		ns

The ● denotes the specifications which apply over $0^\circ\text{C} < T_A < 70^\circ\text{C}$ temperature range. $V_S = 5\text{V}, 0\text{V}$; $V_S = 3\text{V}, 0\text{V}$; $V_{CM} = V_{OUT} = \text{half supply}$, unless otherwise noted.

SYMBOL	PARAMETER	CONDITIONS	MIN	TYP	MAX	UNITS
V_{OS}	Input Offset Voltage	$V_S = 5\text{V}, 0\text{V}, V_{CM} = \text{Half Supply}$ LT6203, LT6204, LT6202S8	●	0.2	0.7	mV
		LT6202 SOT-23	●	0.2	0.9	mV
		$V_S = 3\text{V}, 0\text{V}, V_{CM} = \text{Half Supply}$ LT6203, LT6204, LT6202S8	●	0.6	1.7	mV
		LT6202 SOT-23	●	0.6	1.9	mV
$V_{OS TC}$	Input Offset Voltage Drift (Note 9)	$V_S = 5\text{V}, 0\text{V}, V_{CM} = V^+ \text{ to } V^-$ LT6203, LT6204, LT6202S8	●	0.7	2.5	mV
		LT6202 SOT-23	●	0.7	2.7	mV
		$V_S = 3\text{V}, 0\text{V}, V_{CM} = V^+ \text{ to } V^-$ LT6203, LT6204, LT6202S8	●	1.2	4.0	mV
		LT6202 SOT-23	●	1.2	4.2	mV
	Input Offset Voltage Match (Channel-to-Channel) (Note 6)	$V_{CM} = \text{Half Supply}$	●	0.15	0.9	mV
		$V_{CM} = V^- \text{ to } V^+$	●	0.5	2.3	mV

620234fa

ELECTRICAL CHARACTERISTICS The ● denotes the specifications which apply over 0°C < T_A < 70°C temperature range. V_S = 5V, 0V; V_S = 3V, 0V; V_{CM} = V_{OUT} = half supply, unless otherwise noted.

SYMBOL	PARAMETER	CONDITIONS	MIN	TYP	MAX	UNITS	
I _B	Input Bias Current	V _{CM} = Half Supply	●	-7.0	-1.3	μA	
		V _{CM} = V ⁺	●		1.3	2.5	μA
		V _{CM} = V ⁻	●	-8.8	-3.3		μA
ΔI _B	I _B Shift	V _{CM} = V ⁻ to V ⁺	●	4.7	11.3	μA	
	I _B Match (Channel-to-Channel) (Note 6)		●	0.1	0.6	μA	
I _{OS}	Input Offset Current	V _{CM} = Half Supply	●	0.15	1	μA	
		V _{CM} = V ⁺	●	0.10	1	μA	
		V _{CM} = V ⁻	●	0.15	1.1	μA	
A _{VOL}	Large Signal Gain	V _S = 5V, V _O = 0.5V to 4.5V, R _L = 1k to V _S /2	●	35	60	V/mV	
		V _S = 5V, V _O = 1.5V to 3.5V, R _L = 100 to V _S /2	●	6.0	12	V/mV	
		V _S = 3V, V _O = 0.5V to 2.5V, R _L = 1k to V _S /2	●	15	36	V/mV	
CMRR	Common Mode Rejection Ratio	V _S = 5V, V _{CM} = V ⁻ to V ⁺	●	60	83	dB	
		V _S = 5V, V _{CM} = 1.5V to 3.5V	●	78	97	dB	
		V _S = 3V, V _{CM} = V ⁻ to V ⁺	●	56	75	dB	
	CMRR Match (Channel-to-Channel) (Note 6)	V _S = 5V, V _{CM} = 1.5V to 3.5V	●	83	100	dB	
PSRR	Power Supply Rejection Ratio	V _S = 3V to 10V, V _{CM} = 0V	●	60	70	dB	
		PSRR Match (Channel-to-Channel) (Note 6)	●	70	100	dB	
	Minimum Supply Voltage (Note 7)		●	3.0		V	
V _{OL}	Output Voltage Swing LOW Saturation (Note 8)	No Load	●	5.0	60	mV	
		I _{SINK} = 5mA	●	95	200	mV	
		I _{SINK} = 15mA	●	260	365	mV	
V _{OH}	Output Voltage Swing HIGH Saturation (Note 8)	No Load	●	50	100	mV	
		I _{SOURCE} = 5mA	●	115	230	mV	
		V _S = 5V, I _{SOURCE} = 20mA	●	360	635	mV	
		V _S = 3V, I _{SOURCE} = 15mA	●	260	430	mV	
I _{SC}	Short-Circuit Current	V _S = 5V	●	±20	±33	mA	
		V _S = 3V	●	±20	±30	mA	
I _S	Supply Current per Amp	V _S = 5V	●	3.1	3.85	mA	
		V _S = 3V	●	2.75	3.50	mA	
GBW	Gain Bandwidth Product	Frequency = 1MHz	●	87		MHz	
SR	Slew Rate	V _S = 5V, A _V = -1, R _L = 1k, V _O = 4V	●	15	21	V/μs	
FPBW	Full Power Bandwidth (Note 10)	V _S = 5V, V _{OUT} = 3V _{P-P}	●	1.6	2.2	MHz	

The ● denotes the specifications which apply over -40°C < T_A < 85°C temperature range. V_S = 5V, 0V; V_S = 3V, 0V; V_{CM} = V_{OUT} = half supply, unless otherwise noted. (Note 5)

SYMBOL	PARAMETER	CONDITIONS	MIN	TYP	MAX	UNITS
V _{OS}	Input Offset Voltage	V _S = 5V, 0V, V _{CM} = Half Supply LT6203, LT6204, LT6202S8 LT6202 SOT-23	●	0.2	0.8	mV
			●	0.2	1.0	mV
		V _S = 3V, 0V, V _{CM} = Half Supply LT6203, LT6204, LT6202S8 LT6202 SOT-23	●	0.6	2.0	mV
			●	0.6	2.2	mV
		V _S = 5V, 0V, V _{CM} = V ⁺ to V ⁻ LT6203, LT6204, LT6202S8 LT6202 SOT-23	●	1.0	3.0	mV
			●	1.0	3.5	mV
		V _S = 3V, 0V, V _{CM} = V ⁺ to V ⁻ LT6203, LT6204, LT6202S8 LT6202 SOT-23	●	1.4	4.5	mV
			●	1.4	4.7	mV

LT6202/LT6203/LT6204

ELECTRICAL CHARACTERISTICS The ● denotes the specifications which apply over $-40^{\circ}\text{C} < T_A < 85^{\circ}\text{C}$ temperature range. $V_S = 5\text{V}, 0\text{V}; V_S = 3\text{V}, 0\text{V}; V_{CM} = V_{OUT} = \text{half supply}$, unless otherwise noted. (Note 5)

SYMBOL	PARAMETER	CONDITIONS		MIN	TYP	MAX	UNITS	
$V_{OS\ TC}$	Input Offset Voltage Drift (Note 9)	$V_{CM} = \text{Half Supply}$	●		3.0	9.0	$\mu\text{V}/^{\circ}\text{C}$	
	Input Offset Voltage Match (Channel-to-Channel) (Note 6)	$V_{CM} = \text{Half Supply}$	●		0.3	1.0	mV	
$V_{CM} = V^- \text{ to } V^+$		●		0.7	2.5	mV		
I_B	Input Bias Current	$V_{CM} = \text{Half Supply}$	●	-7.0	-1.3		μA	
		$V_{CM} = V^+$	●		1.3	2.5	μA	
		$V_{CM} = V^-$	●	-8.8	-3.3		μA	
ΔI_B	I_B Shift	$V_{CM} = V^- \text{ to } V^+$	●		4.7	11.3	μA	
	I_B Match (Channel-to-Channel) (Note 6)		●		0.1	0.6	μA	
I_{OS}	Input Offset Current	$V_{CM} = \text{Half Supply}$	●		0.2	1	μA	
		$V_{CM} = V^+$	●		0.2	1.1	μA	
		$V_{CM} = V^-$	●		0.2	1.2	μA	
A_{VOL}	Large Signal Gain	$V_S = 5\text{V}, V_O = 0.5\text{V to } 4.5\text{V}, R_L = 1\text{k to } V_S/2$	●	32	60		V/mV	
		$V_S = 5\text{V}, V_O = 1.5\text{V to } 3.5\text{V}, R_L = 100 \text{ to } V_S/2$	●	4.0	10		V/mV	
		$V_S = 3\text{V}, V_O = 0.5\text{V to } 2.5\text{V}, R_L = 1\text{k to } V_S/2$	●	13	32		V/mV	
CMRR	Common Mode Rejection Ratio	$V_S = 5\text{V}, V_{CM} = V^- \text{ to } V^+$	●	60	80		dB	
		$V_S = 5\text{V}, V_{CM} = 1.5\text{V to } 3.5\text{V}$	●	75	95		dB	
		$V_S = 3\text{V}, V_{CM} = V^- \text{ to } V^+$	●	56	75		dB	
	CMRR Match (Channel-to-Channel) (Note 6)	$V_S = 5\text{V}, V_{CM} = 1.5\text{V to } 3.5\text{V}$	●	80	100		dB	
PSRR	Power Supply Rejection Ratio	$V_S = 3\text{V to } 10\text{V}, V_{CM} = 0\text{V}$	●	60	70		dB	
		PSRR Match (Channel-to-Channel) (Note 6)	$V_S = 3\text{V to } 10\text{V}, V_{CM} = 0\text{V}$	●	70	100		dB
		Minimum Supply Voltage (Note 7)		●	3.0			V
V_{OL}	Output Voltage Swing LOW Saturation (Note 8)	No Load	●		6	70	mV	
		$I_{SINK} = 5\text{mA}$	●		95	210	mV	
		$I_{SINK} = 15\text{mA}$	●		210	400	mV	
V_{OH}	Output Voltage Swing HIGH Saturation (Note 8)	No Load	●		55	110	mV	
		$I_{SOURCE} = 5\text{mA}$	●		125	240	mV	
		$V_S = 5\text{V}, I_{SOURCE} = 15\text{mA}$	●		370	650	mV	
		$V_S = 3\text{V}, I_{SOURCE} = 15\text{mA}$	●		270	650	mV	
I_{SC}	Short-Circuit Current	$V_S = 5\text{V}$	●	± 15	± 25		mA	
		$V_S = 3\text{V}$	●	± 15	± 23		mA	
I_S	Supply Current per Amp	$V_S = 5\text{V}$	●		3.3	4.1	mA	
		$V_S = 3\text{V}$	●		3.0	3.65	mA	
GBW	Gain Bandwidth Product	Frequency = 1MHz	●		83		MHz	
SR	Slew Rate	$V_S = 5\text{V}, A_V = -1, R_L = 1\text{k}, V_O = 4\text{V}$	●	12	17		V/ μs	
FPBW	Full Power Bandwidth (Note 10)	$V_S = 5\text{V}, V_{OUT} = 3V_{P-P}$	●	1.3	1.8		MHz	

ELECTRICAL CHARACTERISTICS $T_A = 25^\circ\text{C}$, $V_S = \pm 5\text{V}$; $V_{CM} = V_{OUT} = 0\text{V}$, unless otherwise noted.

SYMBOL	PARAMETER	CONDITIONS	MIN	TYP	MAX	UNITS
V_{OS}	Input Offset Voltage	LT6203, LT6204, LT6202S8 $V_{CM} = 0\text{V}$ $V_{CM} = V^+$ $V_{CM} = V^-$		1.0 2.6 2.3	2.5 5.5 5.0	mV mV mV
		LT6202 SOT-23 $V_{CM} = 0\text{V}$ $V_{CM} = V^+$ $V_{CM} = V^-$		1.0 2.6 2.3	2.7 6.0 5.5	mV mV mV
	Input Offset Voltage Match (Channel-to-Channel) (Note 6)	$V_{CM} = 0\text{V}$ $V_{CM} = V^-$ to V^+		0.2 0.4	1.0 2.0	mV mV
I_B	Input Bias Current	$V_{CM} = \text{Half Supply}$ $V_{CM} = V^+$ $V_{CM} = V^-$	-7.0 -9.5	-1.3 1.3 -3.8	3.0	μA μA μA
ΔI_B	I_B Shift	$V_{CM} = V^-$ to V^+		5.3	12.5	μA
	I_B Match (Channel-to-Channel) (Note 6)			0.1	0.6	μA
I_{OS}	Input Offset Current	$V_{CM} = \text{Half Supply}$ $V_{CM} = V^+$ $V_{CM} = V^-$		0.15 0.2 0.35	1 1.2 1.3	μA μA μA
		Input Noise Voltage	0.1Hz to 10Hz		800	$\text{nV}_{\text{P-P}}$
e_n	Input Noise Voltage Density	$f = 100\text{kHz}$		1.9		$\text{nV}/\sqrt{\text{Hz}}$
		$f = 10\text{kHz}$		2.8	4.5	$\text{nV}/\sqrt{\text{Hz}}$
i_n	Input Noise Current Density, Balanced Input Noise Current Density, Unbalanced	$f = 10\text{kHz}$		0.75		$\text{pA}/\sqrt{\text{Hz}}$
				1.1		$\text{pA}/\sqrt{\text{Hz}}$
	Input Resistance	Common Mode Differential Mode		4 12		$\text{M}\Omega$ $\text{k}\Omega$
C_{IN}	Input Capacitance	Common Mode Differential Mode		1.8 1.5		pF pF
		Large Signal Gain	$V_O = \pm 4.5\text{V}$, $R_L = 1\text{k}$ $V_O = \pm 2.5\text{V}$, $R_L = 100$	75 11	130 19	V/mV V/mV
CMRR	Common Mode Rejection Ratio	$V_{CM} = V^-$ to V^+ $V_{CM} = -2\text{V}$ to 2V	65 85	85 98		dB dB
		CMRR Match (Channel-to-Channel) (Note 6)	$V_{CM} = -2\text{V}$ to 2V	85	120	dB
PSRR	Power Supply Rejection Ratio	$V_S = \pm 1.25\text{V}$ to $\pm 5\text{V}$	60	74		dB
		PSRR Match (Channel-to-Channel) (Note 6)	$V_S = \pm 1.25\text{V}$ to $\pm 5\text{V}$	70	100	dB
V_{OL}	Output Voltage Swing LOW Saturation (Note 8)	No Load		5	50	mV
		$I_{\text{SINK}} = 5\text{mA}$		87	190	mV
		$I_{\text{SINK}} = 20\text{mA}$		245	460	mV
V_{OH}	Output Voltage Swing HIGH Saturation (Note 8)	No Load		40	95	mV
		$I_{\text{SOURCE}} = 5\text{mA}$		95	210	mV
		$I_{\text{SOURCE}} = 20\text{mA}$		320	600	mV
I_{SC}	Short-Circuit Current		± 30	± 40		mA
I_S	Supply Current per Amp			2.8	3.5	mA
GBW	Gain Bandwidth Product	Frequency = 1MHz	70	100		MHz
SR	Slew Rate	$A_V = -1$, $R_L = 1\text{k}$, $V_O = 4\text{V}$	18	25		$\text{V}/\mu\text{s}$
FPBW	Full Power Bandwidth (Note 10)	$V_{OUT} = 3\text{V}_{\text{P-P}}$	1.9	2.6		MHz
t_S	Settling Time	0.1%, $V_{\text{STEP}} = 2\text{V}$, $A_V = -1$, $R_L = 1\text{k}$		78		ns
dG	Differential Gain (Note 11)	$A_V = 2$, $R_F = R_G = 499\Omega$, $R_L = 2\text{k}$		0.05		%
dP	Differential Phase (Note 11)	$A_V = 2$, $R_F = R_G = 499\Omega$, $R_L = 2\text{k}$		0.03		DEG

LT6202/LT6203/LT6204

ELECTRICAL CHARACTERISTICS

The ● denotes the specifications which apply over 0°C < T_A < 70°C temperature range. V_S = ±5V; V_{CM} = V_{OUT} = 0V, unless otherwise noted.

SYMBOL	PARAMETER	CONDITIONS	MIN	TYP	MAX	UNITS
V _{OS}	Input Offset Voltage	LT6203, LT6204, LT6202S8 V _{CM} = 0V V _{CM} = V ⁺ V _{CM} = V ⁻	● ● ●	1.6 3.2 2.8	2.8 6.8 5.8	mV mV mV
		LT6202 SOT-23 V _{CM} = 0V V _{CM} = V ⁺ V _{CM} = V ⁻	● ● ●	1.6 3.2 2.8	3.0 7.3 6.3	mV mV mV
V _{OS TC}	Input Offset Voltage Drift (Note 9)	V _{CM} = Half Supply	●	7.5	24	μV/°C
I _B	Input Bias Current	V _{CM} = Half Supply V _{CM} = V ⁺ V _{CM} = V ⁻	● ● ●	-7.0 -1.4 -10	-1.4 3.6 -4.3	μA μA μA
		ΔI _B	I _B Shift	V _{CM} = V ⁻ to V ⁺	●	5.4
I _{OS}	Input Offset Current	V _{CM} = Half Supply V _{CM} = V ⁺ V _{CM} = V ⁻	● ● ●	0.1 0.2 0.4	1 1.2 1.4	μA μA μA
		A _{VOL}	Large Signal Gain	V _O = ±4.5V, R _L = 1k V _O = ±2V, R _L = 100	● ●	70 10
CMRR	Common Mode Rejection Ratio			V _{CM} = V ⁻ to V ⁺ V _{CM} = -2V to 2V	● ●	65 83
		CMRR Match (Channel-to-Channel) (Note 6)	V _{CM} = -2V to 2V	●	83	110
PSRR	Power Supply Rejection Ratio	V _S = ±1.5V to ±5V	●	60	70	dB
		PSRR Match (Channel-to-Channel) (Note 6)	V _S = ±1.5V to ±5V	●	70	100
V _{OL}	Output Voltage Swing LOW Saturation (Note 8)	No Load	●	6	70	mV
		I _{SINK} = 5mA	●	95	200	mV
		I _{SINK} = 15mA	●	210	400	mV
V _{OH}	Output Voltage Swing HIGH Saturation (Note 8)	No Load	●	65	120	mV
		I _{SOURCE} = 5mA	●	125	240	mV
		I _{SOURCE} = 20mA	●	350	625	mV
I _{SC}	Short-Circuit Current		●	±25	±34	mA
I _S	Supply Current per Amp		●	3.5	4.3	mA
GBW	Gain Bandwidth Product	Frequency = 1MHz	●	95		MHz
SR	Slew Rate	A _V = -1, R _L = 1k, V _O = 4V	●	16	22	V/μs
FPBW	Full Power Bandwidth (Note 10)	V _{OUT} = 3V _{P-P}	●	1.7	2.3	MHz

The ● denotes the specifications which apply over -40°C < T_A < 85°C temperature range. V_S = ±5V; V_{CM} = V_{OUT} = 0V, unless otherwise noted. (Note 5)

SYMBOL	PARAMETER	CONDITIONS	MIN	TYP	MAX	UNITS
V _{OS}	Input Offset Voltage	LT6203, LT6204, LT6202S8 V _{CM} = 0V V _{CM} = V ⁺ V _{CM} = V ⁻	● ● ●	1.7 3.8 3.5	3.0 7.5 6.6	mV mV mV
		LT6202 SOT-23 V _{CM} = 0V V _{CM} = V ⁺ V _{CM} = V ⁻	● ● ●	1.7 3.8 3.5	3.2 7.7 6.7	mV mV mV

620234fa

ELECTRICAL CHARACTERISTICS The ● denotes the specifications which apply over $-40^{\circ}\text{C} < T_A < 85^{\circ}\text{C}$ temperature range. $V_S = \pm 5\text{V}$; $V_{CM} = V_{OUT} = 0\text{V}$, unless otherwise noted. (Note 5)

SYMBOL	PARAMETER	CONDITIONS	MIN	TYP	MAX	UNITS
$V_{OS\ TC}$	Input Offset Voltage Drift (Note 9)	$V_{CM} = \text{Half Supply}$	●	7.5	24	$\mu\text{V}/^{\circ}\text{C}$
	Input Offset Voltage Match (Channel-to-Channel) (Note 6)	$V_{CM} = 0\text{V}$ $V_{CM} = V^- \text{ to } V^+$	● ●	0.3 0.6	1.0 2.5	mV mV
I_B	Input Bias Current	$V_{CM} = \text{Half Supply}$	●	-7.0	-1.4	μA
		$V_{CM} = V^+$	●		1.8	μA
		$V_{CM} = V^-$	●	-10	-4.5	μA
ΔI_B	I_B Shift	$V_{CM} = V^- \text{ to } V^+$	●	5.4	13	μA
	I_B Match (Channel-to-Channel) (Note 6)		●	0.15	0.7	μA
I_{OS}	Input Offset Current	$V_{CM} = \text{Half Supply}$	●	0.15	1	μA
		$V_{CM} = V^+$	●	0.3	1.2	μA
		$V_{CM} = V^-$	●	0.5	1.6	μA
A_{VOL}	Large Signal Gain	$V_O = \pm 4.5\text{V}$, $R_L = 1\text{k}$	●	60	110	V/mV
		$V_O = \pm 1.5\text{V}$, $R_L = 100$	●	6.0	13	V/mV
CMRR	Common Mode Rejection Ratio	$V_{CM} = V^- \text{ to } V^+$ $V_{CM} = -2\text{V to } 2\text{V}$	● ●	65 80	84 95	dB dB
	CMRR Match (Channel-to-Channel) (Note 6)	$V_{CM} = -2\text{V to } 2\text{V}$	●	80	110	dB
PSRR	Power Supply Rejection Ratio	$V_S = \pm 1.5\text{V to } \pm 5\text{V}$	●	60	70	dB
	PSRR Match (Channel-to-Channel) (Note 6)	$V_S = \pm 1.5\text{V to } \pm 5\text{V}$	●	70	100	dB
V_{OL}	Output Voltage Swing LOW Saturation (Note 8)	No Load	●	7	75	mV
		$I_{SINK} = 5\text{mA}$	●	98	205	mV
		$I_{SINK} = 15\text{mA}$	●	260	500	mV
V_{OH}	Output Voltage Swing HIGH Saturation (Note 8)	No Load	●	70	130	mV
		$I_{SOURCE} = 5\text{mA}$	●	130	250	mV
		$I_{SOURCE} = 15\text{mA}$	●	360	640	mV
I_{SC}	Short-Circuit Current		●	± 15	± 25	mA
I_S	Supply Current per Amp		●	3.8	4.5	mA
GBW	Gain Bandwidth Product	Frequency = 1MHz	●	90		MHz
SR	Slew Rate	$A_V = -1$, $R_L = 1\text{k}$, $V_O = 4\text{V}$	●	13	18	V/ μs
FPBW	Full Power Bandwidth (Note 10)	$V_{OUT} = 3V_{P-P}$	●	1.4	1.9	MHz

Note 1: Absolute maximum ratings are those values beyond which the life of the device may be impaired.

Note 2: Inputs are protected by back-to-back diodes and diodes to each supply. If the inputs are taken beyond the supplies or the differential input voltage exceeds 0.7V, the input current must be limited to less than 40mA.

Note 3: A heat sink may be required to keep the junction temperature below the absolute maximum rating when the output is shorted indefinitely.

Note 4: The LT6202C/LT6202I, LT6203C/LT6203I and LT6204C/LT6204I are guaranteed functional over the temperature range of -40°C and 85°C .

Note 5: The LT6202C/LT6203C/LT6204C are guaranteed to meet specified performance from 0°C to 70°C . The LT6202C/LT6203C/LT6204C are designed, characterized and expected to meet specified performance from -40°C to 85°C , but are not tested or QA sampled at these temperatures.

The LT6202I/LT6203I/LT6204I are guaranteed to meet specified performance from -40°C to 85°C .

Note 6: Matching parameters are the difference between the two amplifiers A and D and between B and C of the LT6204; between the two amplifiers of the LT6203. CMRR and PSRR match are defined as follows: CMRR and PSRR are measured in $\mu\text{V/V}$ on the identical amplifiers. The difference is calculated between the matching sides in $\mu\text{V/V}$. The result is converted to dB.

Note 7: Minimum supply voltage is guaranteed by power supply rejection ratio test.

Note 8: Output voltage swings are measured between the output and power supply rails.

Note 9: This parameter is not 100% tested.

Note 10: Full-power bandwidth is calculated from the slew rate: $FPBW = SR/2\pi V_P$

Note 11: Differential gain and phase are measured using a Tektronix TSG120YC/NTSC signal generator and a Tektronix 1780R Video Measurement Set. The resolution of this equipment is 0.1% and 0.1° . Ten identical amplifier stages were cascaded giving an effective resolution of 0.01% and 0.01° .

TYPICAL PERFORMANCE CHARACTERISTICS

V_{OS} Distribution, $V_{CM} = V^+/2$

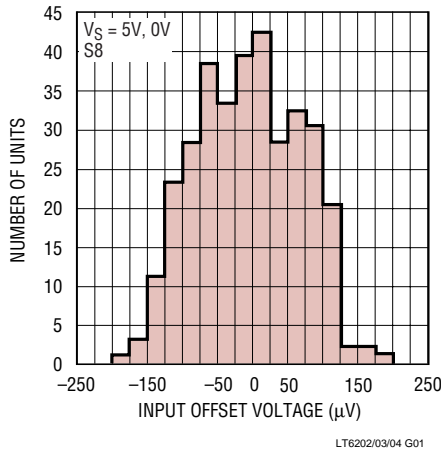

V_{OS} Distribution, $V_{CM} = V^+$

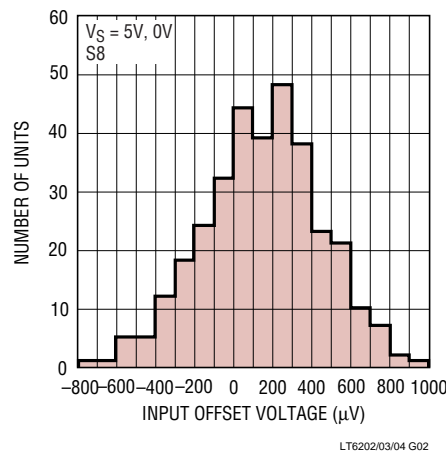

V_{OS} Distribution, $V_{CM} = V^-$

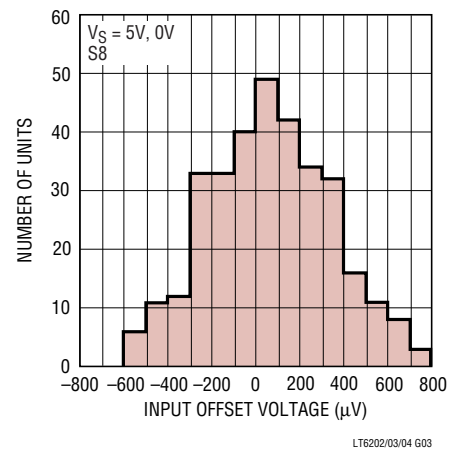

Supply Current vs Supply Voltage (Both Amplifiers)

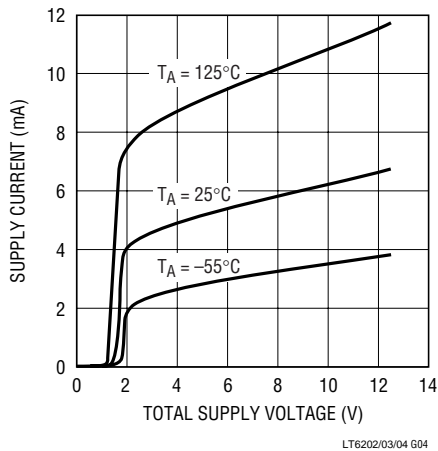

Offset Voltage vs Input Common Mode Voltage

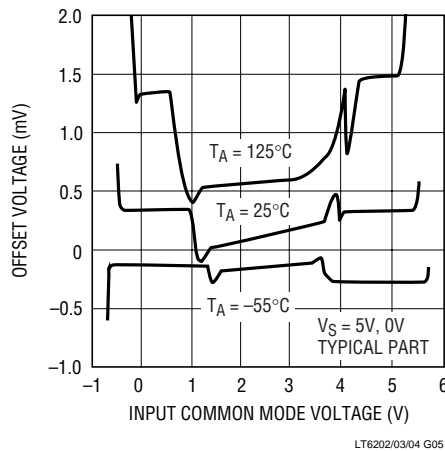

Input Bias Current vs Common Mode Voltage

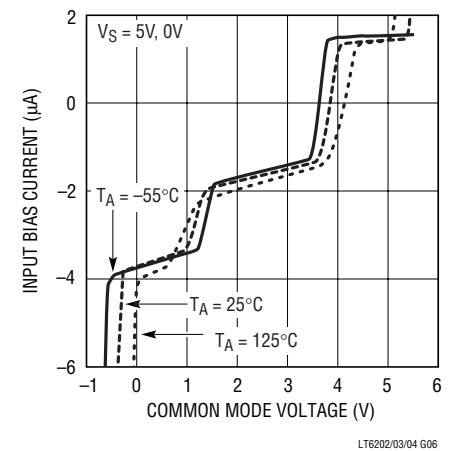

Input Bias Current vs Temperature

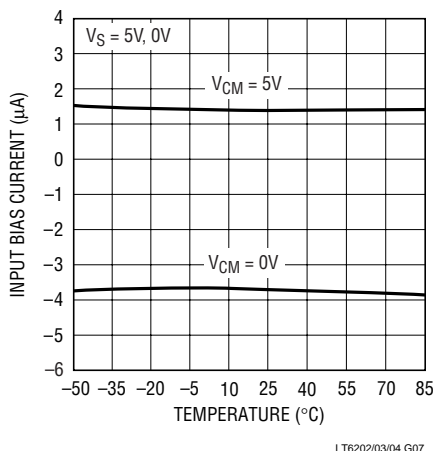

Output Saturation Voltage vs Load Current (Output Low)

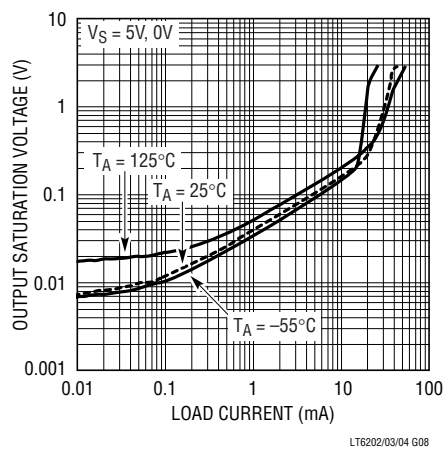

Output Saturation Voltage vs Load Current (Output High)

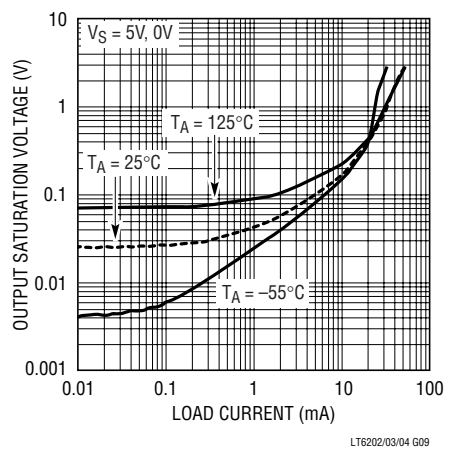

TYPICAL PERFORMANCE CHARACTERISTICS

Minimum Supply Voltage

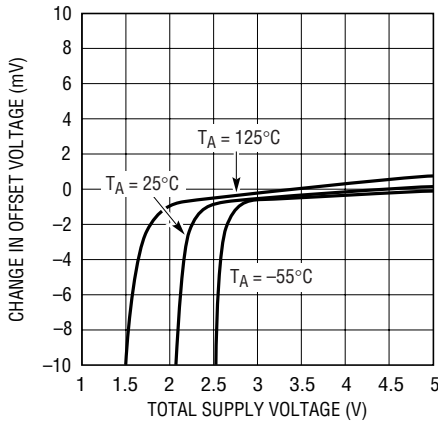

LT6202/03/04 G10

Output Short-Circuit Current vs Power Supply Voltage

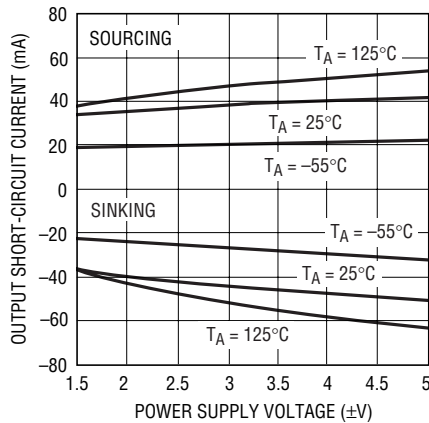

LT6202/03/04 G11

Open-Loop Gain

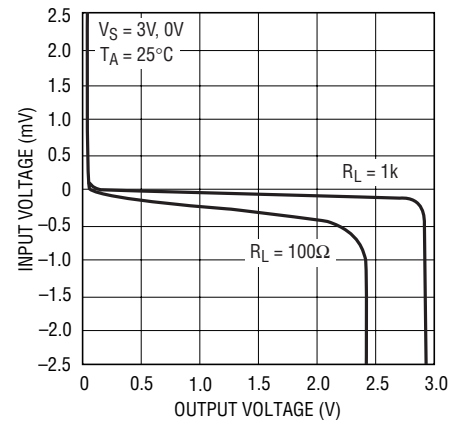

LT6202/03/04 G12

Open-Loop Gain

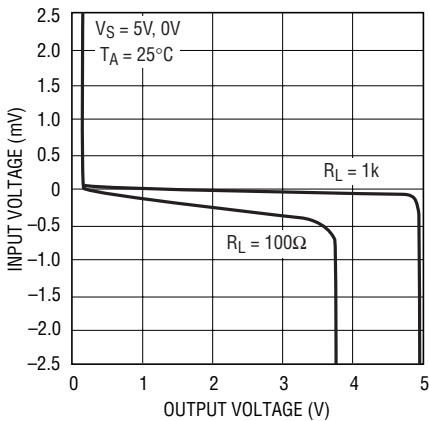

LT6202/03/04 G13

Open-Loop Gain

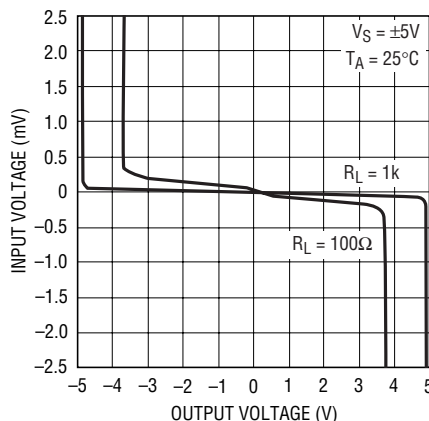

LT6202/03/04 G14

Offset Voltage vs Output Current

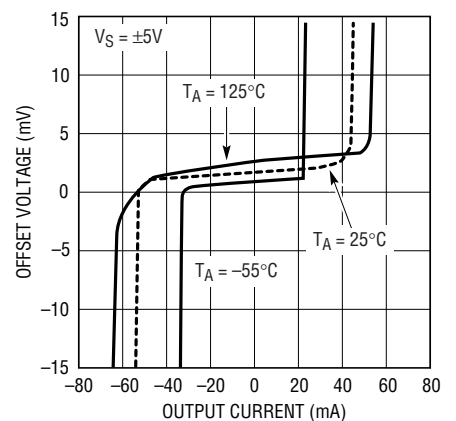

LT6202/03/04 G15

Warm-Up Drift vs Time (LT6203S8)

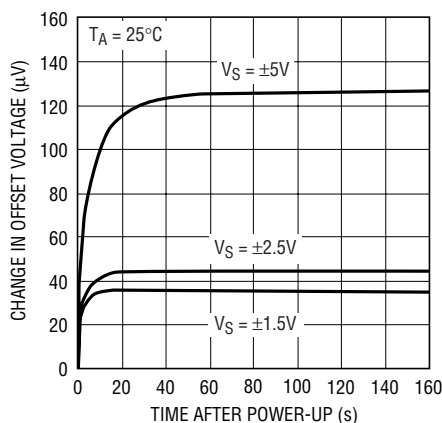

LT6202/03/04 G16

Total Noise vs Total Source Resistance

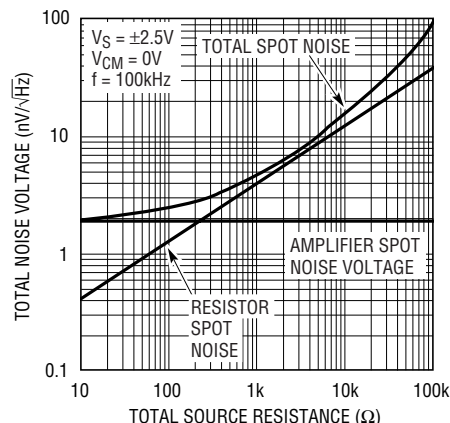

LT6202/03/04 G17

Input Noise Voltage vs Frequency

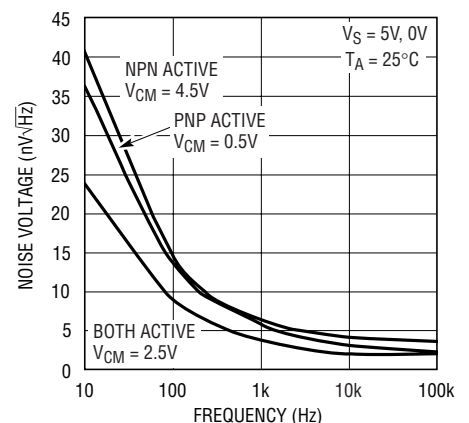

LT6202/03/04 G18

TYPICAL PERFORMANCE CHARACTERISTICS

Balanced Noise Current vs Frequency

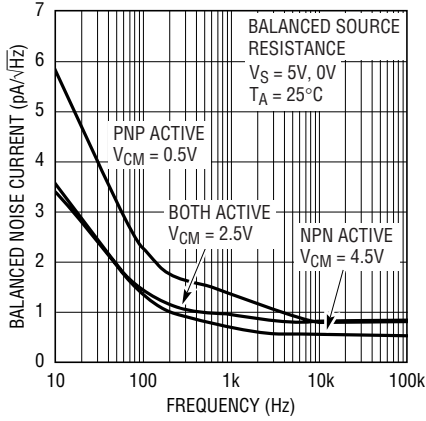

LT6202/03/04 G19

Unbalanced Noise Current vs Frequency

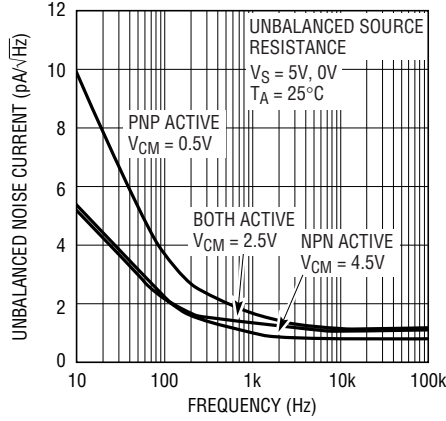

LT6202/03/04 G19.1

0.1Hz to 10Hz Output Voltage Noise

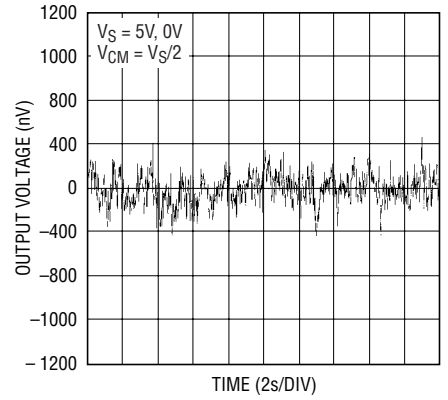

LT6202/03/04 G20

Gain Bandwidth and Phase Margin vs Temperature

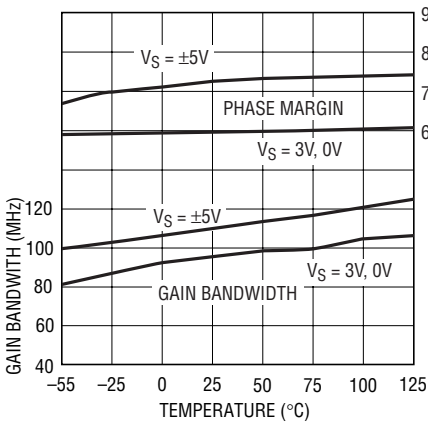

LT6202/03/04 G21

Open-Loop Gain vs Frequency

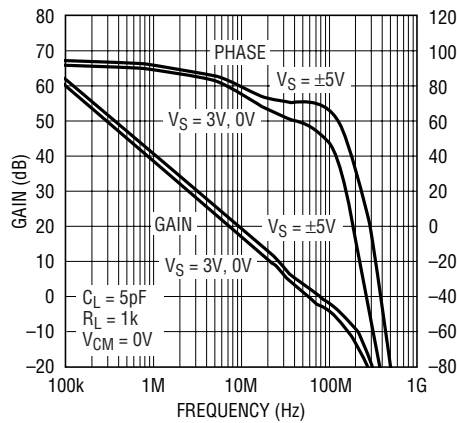

LT6202/03/04 G22

Open-Loop Gain vs Frequency

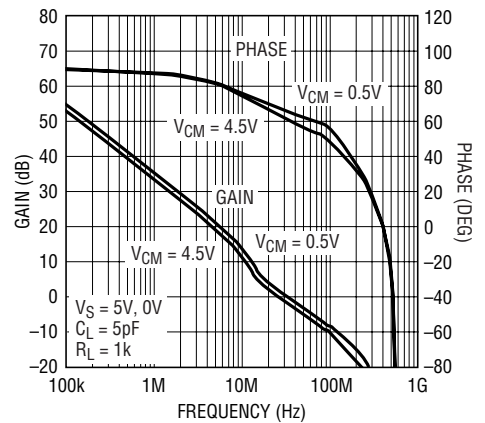

LT6202/03/04 G23

Gain Bandwidth and Phase Margin vs Supply Voltage

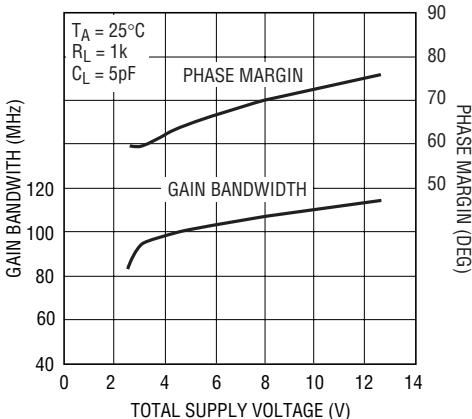

LT6202/03/04 G24

Slew Rate vs Temperature

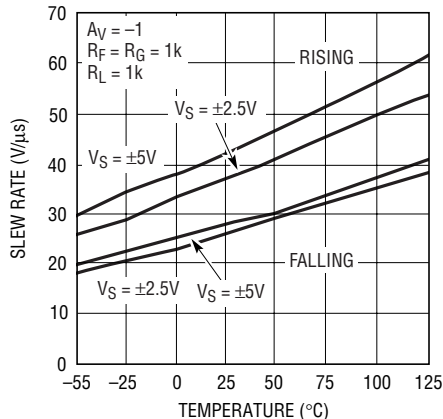

LT6202/03/04 G25

Output Impedance vs Frequency

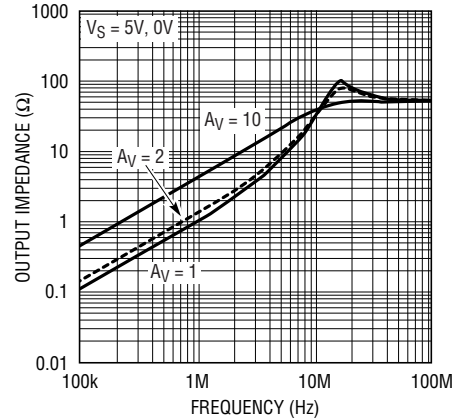

LT6202/03/04 G26

TYPICAL PERFORMANCE CHARACTERISTICS

Common Mode Rejection Ratio vs Frequency

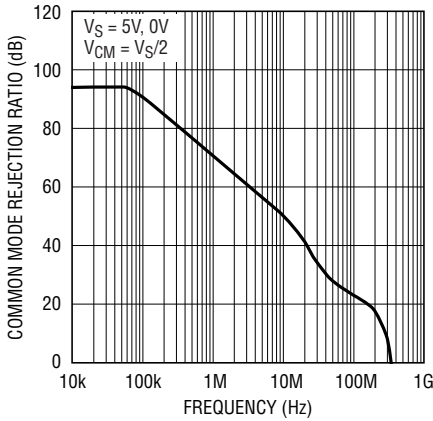

LT6202/03/04 G27

Channel Separation vs Frequency

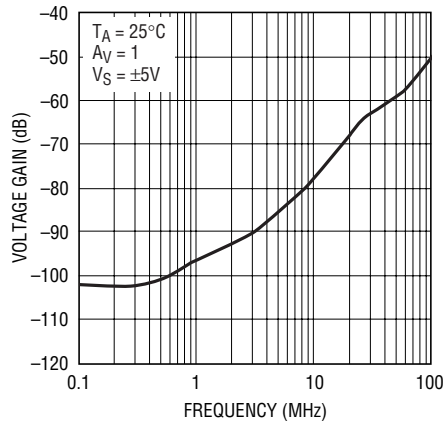

LT6202/03/04 G27.1

Power Supply Rejection Ratio vs Frequency

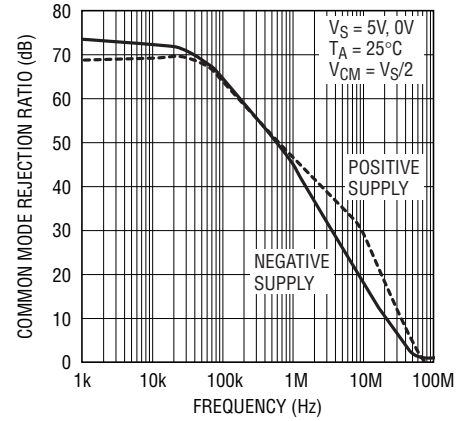

LT6202/03/04 G28

Series Output Resistor vs Capacitive Load

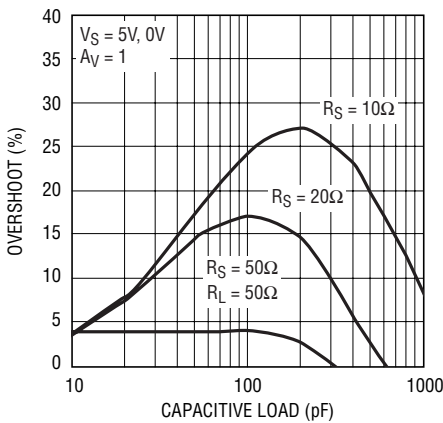

LT6202/03/04 G29

Series Output Resistor vs Capacitive Load

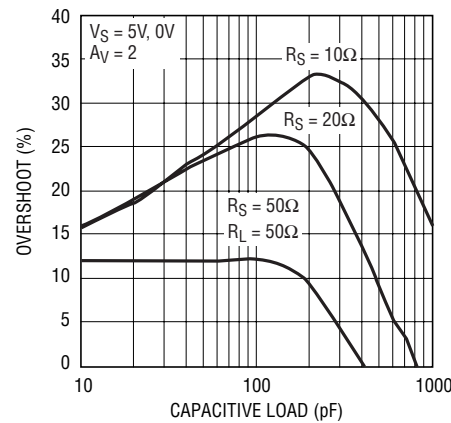

LT6202/03/04 G30

Settling Time vs Output Step (Noninverting)

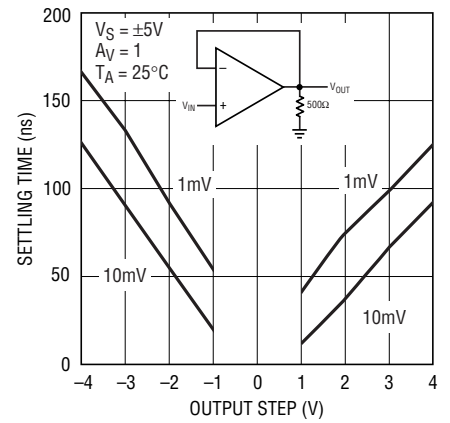

LT6202/03/04 G31

Settling Time vs Output Step (Inverting)

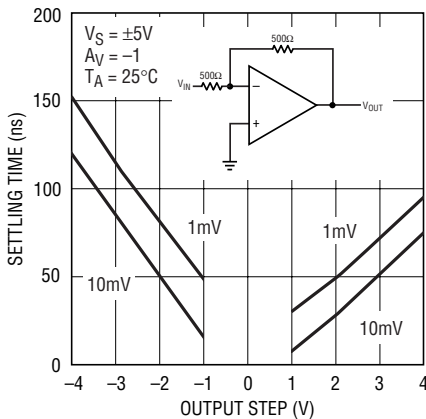

LT6202/03/04 G32

Maximum Undistorted Output Signal vs Frequency

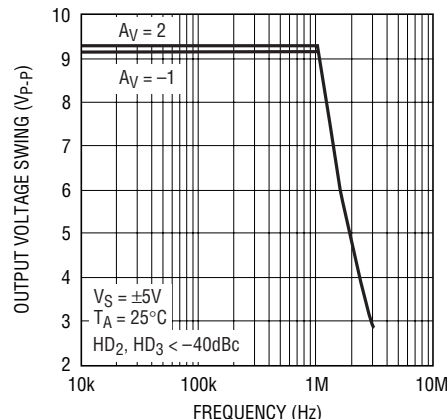

LT6202/03/04 G33

Distortion vs Frequency

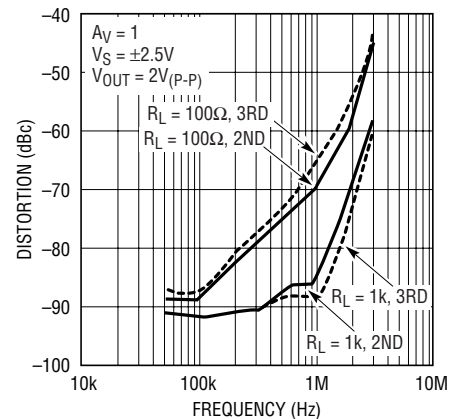

LT6202/03/04 G34

TYPICAL PERFORMANCE CHARACTERISTICS

Distortion vs Frequency

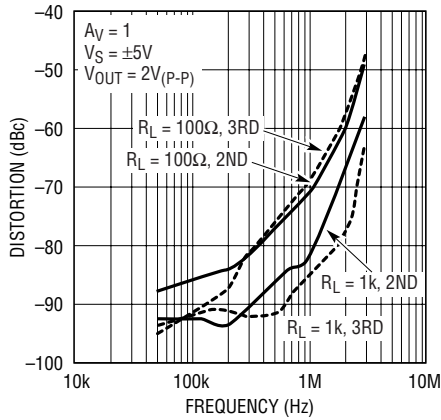

Distortion vs Frequency

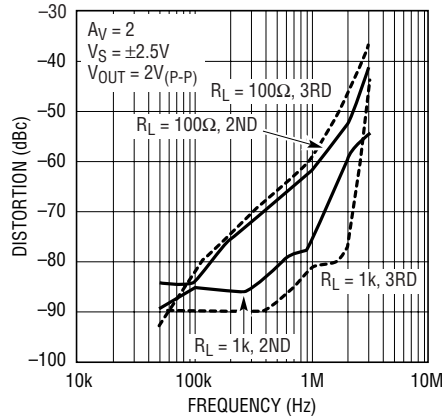

Distortion vs Frequency

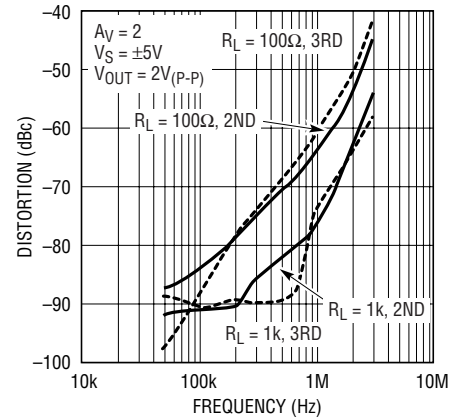

5V Large-Signal Response

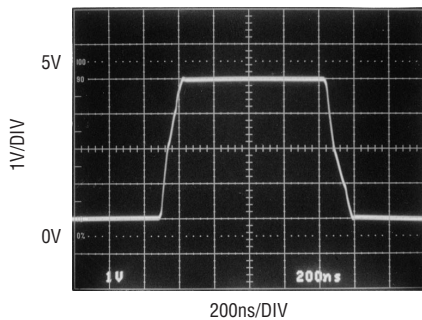

5V Small-Signal Response

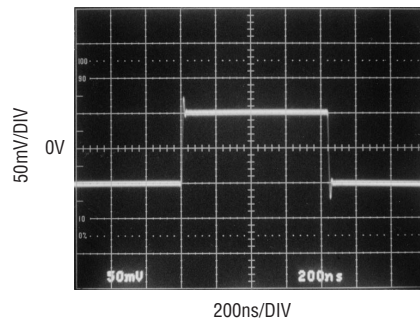

±5V Large-Signal Response

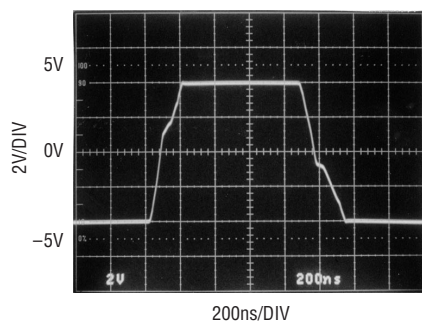

Output-Overdrive Recovery

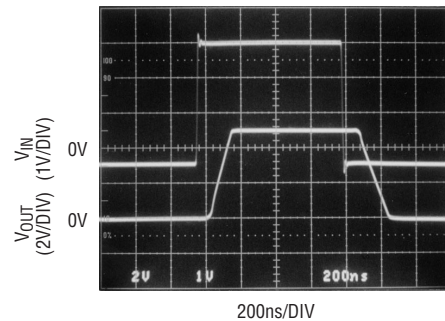

APPLICATIONS INFORMATION

Amplifier Characteristics

Figure 1 shows a simplified schematic of the LT6202/LT6203/LT6204, which has two input differential amplifiers in parallel that are biased on simultaneously when the common mode voltage is at least 1.5V from either rail. This topology allows the input stage to swing from the positive supply voltage to the negative supply voltage. As the common mode voltage swings beyond $V_{CC} - 1.5V$, current source I_1 saturates and current in Q1/Q4 is zero. Feedback is maintained through the Q2/Q3 differential amplifier, but with an input g_m reduction of 1/2. A similar effect occurs with I_2 when the common mode voltage swings within 1.5V of the negative rail. The effect of the g_m reduction is a shift in the V_{OS} as I_1 or I_2 saturate.

Input bias current normally flows out of the + and – inputs. The magnitude of this current increases when the input common mode voltage is within 1.5V of the negative rail, and only Q1/Q4 are active. The polarity of this current reverses when the input common mode voltage is within 1.5V of the positive rail and only Q2/Q3 are active.

The second stage is a folded cascode and current mirror that converts the input stage differential signals to a single ended output. Capacitor C_1 reduces the unity cross frequency and improves the frequency stability without degrading the gain bandwidth of the amplifier. The differential drive generator supplies current to the output transistors that swing from rail-to-rail.

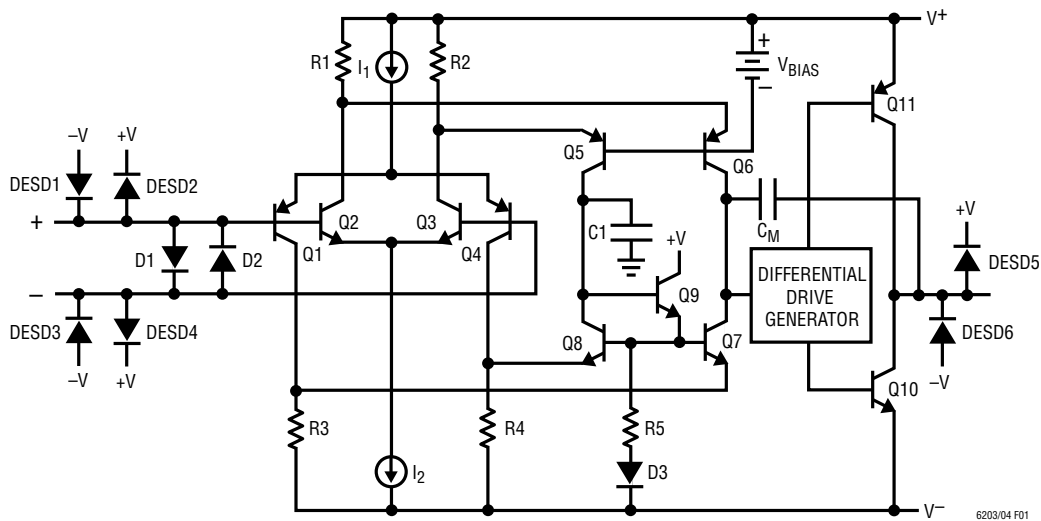

Figure 1. Simplified Schematic

APPLICATIONS INFORMATION

Input Protection

There are back-to-back diodes, D1 and D2, across the + and – inputs of these amplifiers to limit the differential input voltage to $\pm 0.7V$. The inputs of the LT6202/LT6203/LT6304 do not have internal resistors in series with the input transistors. This technique is often used to protect the input devices from over voltage that causes excessive currents to flow. The addition of these resistors would significantly degrade the low noise voltage of these amplifiers. For instance, a 100Ω resistor in series with each input would generate $1.8nV/\sqrt{Hz}$ of noise, and the total amplifier noise voltage would rise from $1.9nV/\sqrt{Hz}$ to $2.6nV/\sqrt{Hz}$. Once the input differential voltage exceeds $\pm 0.7V$, steady state current conducted through the protection diodes should be limited to $\pm 40mA$. This implies 25Ω of protection resistance per volt of continuous overdrive beyond $\pm 0.7V$. The input diodes are rugged enough to handle transient currents due to amplifier slew rate overdrive or momentary clipping without these resistors.

Figure 2 shows the input and output waveforms of the amplifier driven into clipping while connected in a gain of $A_V = 1$. When the input signal goes sufficiently beyond the power supply rails, the input transistors will saturate. When saturation occurs, the amplifier loses a stage of phase inversion and the output tries to change states. Diodes D1 and D2 forward bias and hold the output within

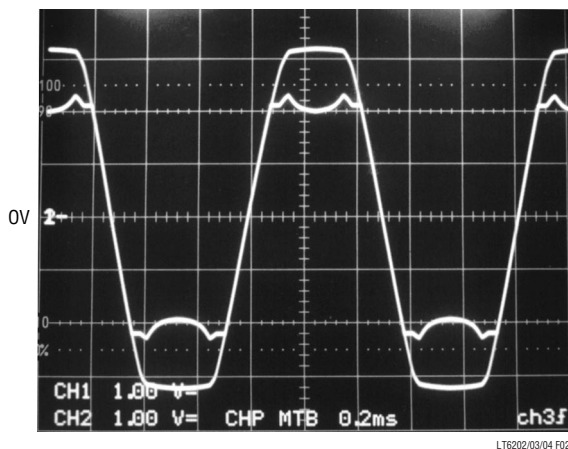

Figure 2. $V_S = \pm 2.5V$, $A_V = 1$ with Large Overdrive

a diode drop of the input signal. In this photo, the input signal generator is clipping at $\pm 35mA$, and the output transistors supply this generator current through the protection diodes.

With the amplifier connected in a gain of $A_V \geq 2$, the output can invert with very heavy input overdrive. To avoid this inversion, limit the input overdrive to $0.5V$ beyond the power supply rails.

ESD

The LT6202/LT6203/LT6204 have reverse-biased ESD protection diodes on all inputs and outputs as shown in Figure 1. If these pins are forced beyond either supply, unlimited current will flow through these diodes. If the current is transient and limited to one hundred milliamps or less, no damage to the device will occur.

Noise

The noise voltage of the LT6202/LT6203/LT6204 is equivalent to that of a 225Ω resistor, and for the lowest possible noise it is desirable to keep the source and feedback resistance at or below this value, i.e. $R_S + R_G \parallel R_{FB} \leq 225\Omega$. With $R_S + R_G \parallel R_{FB} = 225\Omega$ the total noise of the amplifier is: $e_n = \sqrt{(1.9nV)^2 + (1.9nV)^2} = 2.7nV$. Below this resistance value, the amplifier dominates the noise, but in the resistance region between 225Ω and approximately $10k\Omega$, the noise is dominated by the resistor thermal noise. As the total resistance is further increased, beyond $10k$, the noise current multiplied by the total resistance eventually dominates the noise.

The product of $e_n \cdot \sqrt{I_{SUPPLY}}$ is an interesting way to gauge low noise amplifiers. Many low noise amplifiers with low e_n have high I_{SUPPLY} current. In applications that require low noise with the lowest possible supply current, this product can prove to be enlightening. The LT6202/LT6203/LT6204 have an $e_n \cdot \sqrt{I_{SUPPLY}}$ product of 3.2 per amplifier, yet it is common to see amplifiers with similar noise specifications have an $e_n \cdot \sqrt{I_{SUPPLY}}$ product of 4.7 to 13.5.

For a complete discussion of amplifier noise, see the LT1028 data sheet.

TYPICAL APPLICATIONS

Low Noise, Low Power 1MΩ AC Photodiode Transimpedance Amplifier

Figure 3 shows the LT6202 applied as a transimpedance amplifier (TIA). The LT6202 forces the BF862 ultralow-noise JFET source to 0V, with R3 ensuring that the JFET has an I_{DRAIN} of 1mA. The JFET acts as a source follower, buffering the input of the LT6202 and making it suitable for the high impedance feedback elements R1 and R2. The BF862 has a minimum I_{DSS} of 10mA and a pinchoff voltage between $-0.3V$ and $-1.2V$. The JFET gate and the LT6202

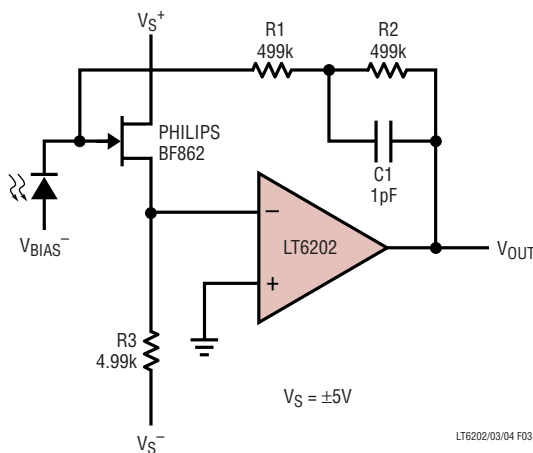

Figure 3. Low Noise, Low Power 1MΩ AC Photodiode Transimpedance Amplifier

output therefore sit at a point slightly higher than one pinchoff voltage below ground (typically about $-0.6V$). When the photodiode is illuminated, the current must come from the LT6202's output through R1 and R2, as in a normal TIA. Amplifier input noise density and gain-bandwidth product were measured at $2.4nV/Hz$ and $100MHz$, respectively. Note that because the JFET has a high g_m , approximately $1/80\Omega$, its attenuation looking into R3 is only about 2%. Gain-bandwidth product was measured at $100MHz$ and the closed-loop bandwidth using a $3pF$ photodiode was approximately $1.4MHz$.

Precision Low Noise, Low Power, 1MΩ Photodiode Transimpedance Amplifier

Figure 4 shows the LT6202 applied as a transimpedance amplifier (TIA), very similar to that shown in Figure 3. In this case, however, the JFET is not allowed to dictate the DC-bias conditions. Rather than being grounded, the LT6202's noninverting input is driven by the LTC2050 to the exact state necessary for zero JFET gate voltage. The noise performance is nearly identical to that of the circuit in Figure 3, with the additional benefit of excellent DC performance. Input offset was measured at under $200\mu V$ and output noise was within $2mV_{P-P}$ over a $20MHz$ bandwidth.

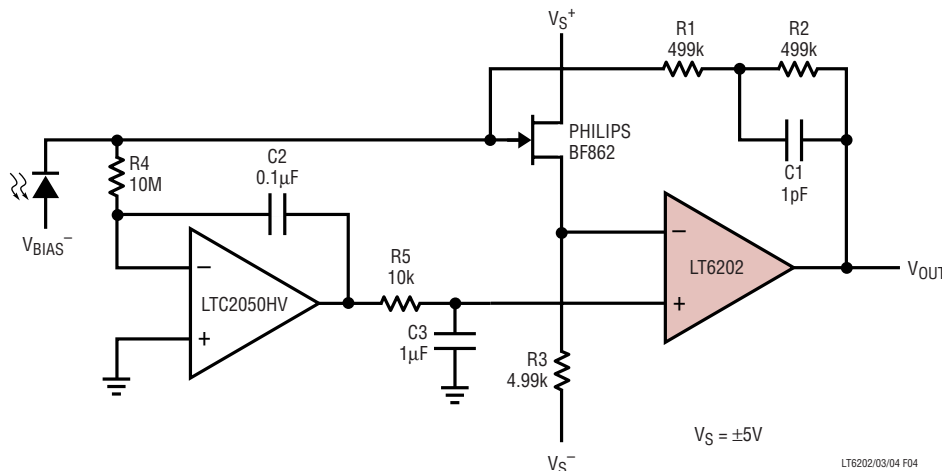

Figure 4. Precision Low Noise, Low Power Transimpedance Amplifier

TYPICAL APPLICATIONS

Single-Supply 16-Bit ADC Driver

Figure 5 shows the LT6203 driving an LTC1864 unipolar 16-bit A/D converter. The bottom half of the LT6203 is in a gain-of-one configuration and buffers the 0V negative full-scale signal V_{LOW} into the negative input of the LTC1864. The top half of the LT6203 is in a gain-of-ten configuration referenced to the buffered voltage V_{LOW} and drives the positive input of the LTC1864. The input range of the LTC1864 is 0V to 5V, but for best results the input range of V_{IN} should be from V_{LOW} (about 0.4V) to about 0.82V. Figure 6 shows an FFT obtained with a 10.1318kHz coherent input waveform, from 8192 samples with no windowing or averaging. Spurious free dynamic range is seen to be about 100dB.

Although the LTC1864 has a sample rate far below the gain bandwidth of the LT6203, using this amplifier is not necessarily a case of overkill. The designer is reminded that A/D converters have sample apertures that are vanishingly small (ideally, infinitesimally small) and make demands on the upstream circuitry far in excess of what is implied by the innocent-looking sample rate. In addition, when an A/D converter takes a sample, it applies a small capacitor to its inputs with a fair amount of glitch energy and expects the voltage on the capacitor to settle to the true value very quickly. Finally, the LTC1864 has a 20MHz analog input bandwidth and can be used in undersampling applications, again requiring a source bandwidth higher than Nyquist.

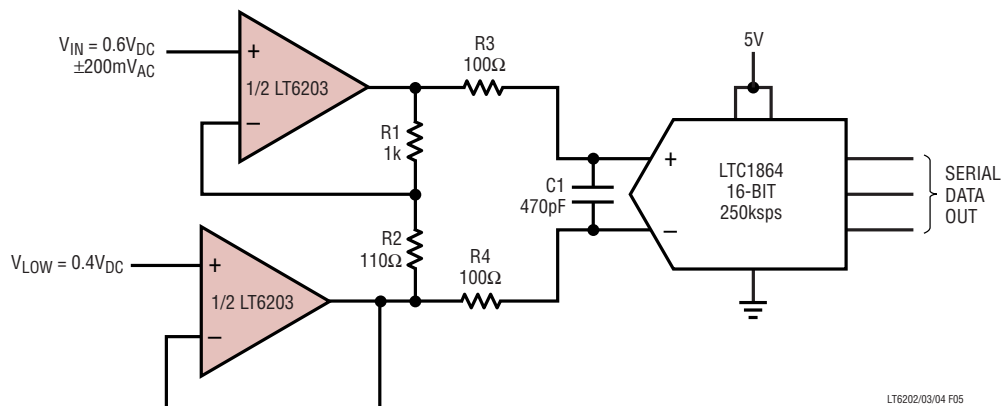

Figure 5. Single-Supply 16-Bit ADC Driver

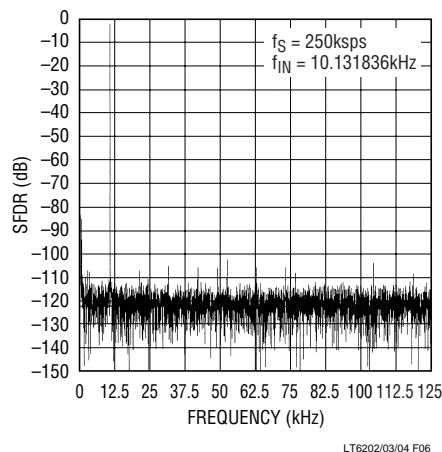
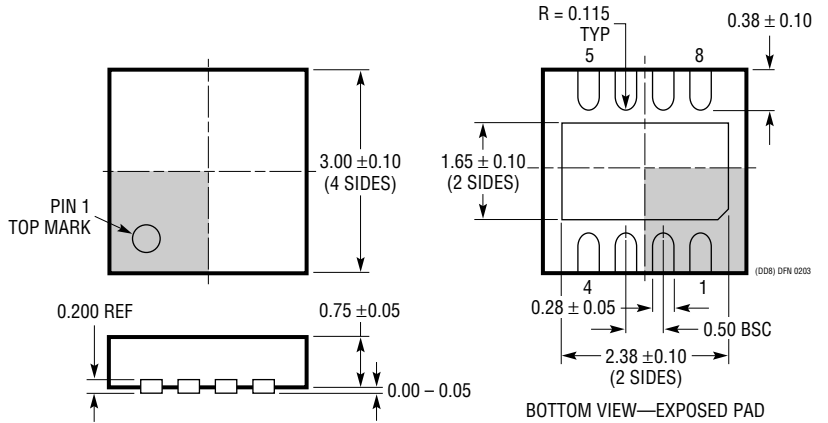
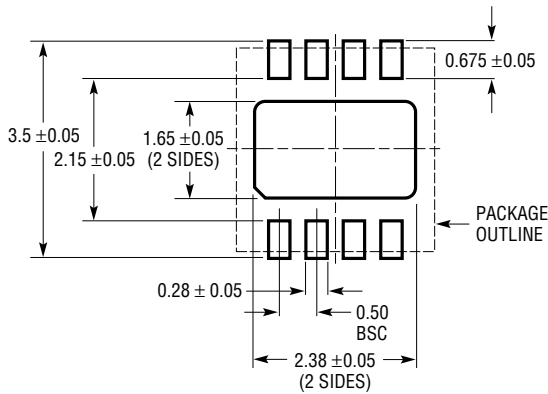

Figure 6. FFT Showing 100dB SFDR

PACKAGE DESCRIPTION

DD Package 8-Lead Plastic DFN (3mm × 3mm) (Reference LTC DWG # 05-08-1698)



- NOTE:
1. DRAWING TO BE MADE A JEDEC PACKAGE OUTLINE M0-229 VARIATION OF (WEED-1)
 2. ALL DIMENSIONS ARE IN MILLIMETERS
 3. DIMENSIONS OF EXPOSED PAD ON BOTTOM OF PACKAGE DO NOT INCLUDE MOLD FLASH. MOLD FLASH, IF PRESENT, SHALL NOT EXCEED 0.15mm ON ANY SIDE
 4. EXPOSED PAD SHALL BE SOLDER PLATED

GN Package 16-Lead Plastic SSOP (Narrow .150 Inch) (Reference LTC DWG # 05-08-1641)

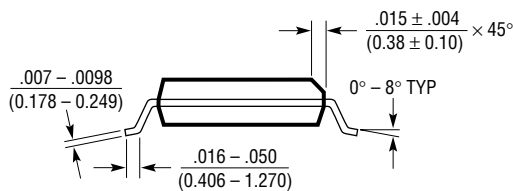
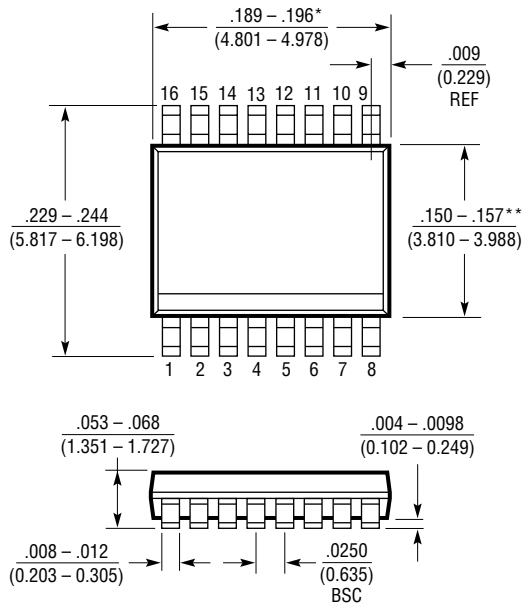
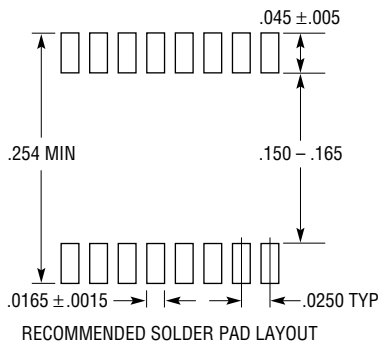

- NOTE:
1. CONTROLLING DIMENSION: INCHES
 2. DIMENSIONS ARE IN $\frac{\text{INCHES}}{\text{MILLIMETERS}}$
 3. DRAWING NOT TO SCALE
- *DIMENSION DOES NOT INCLUDE MOLD FLASH. MOLD FLASH SHALL NOT EXCEED 0.006" (0.152mm) PER SIDE
- **DIMENSION DOES NOT INCLUDE INTERLEAD FLASH. INTERLEAD FLASH SHALL NOT EXCEED 0.010" (0.254mm) PER SIDE

GN16 (SSOP) 0502

PACKAGE DESCRIPTION

MS8 Package
8-Lead Plastic MSOP
 (Reference LTC DWG # 05-08-1660)

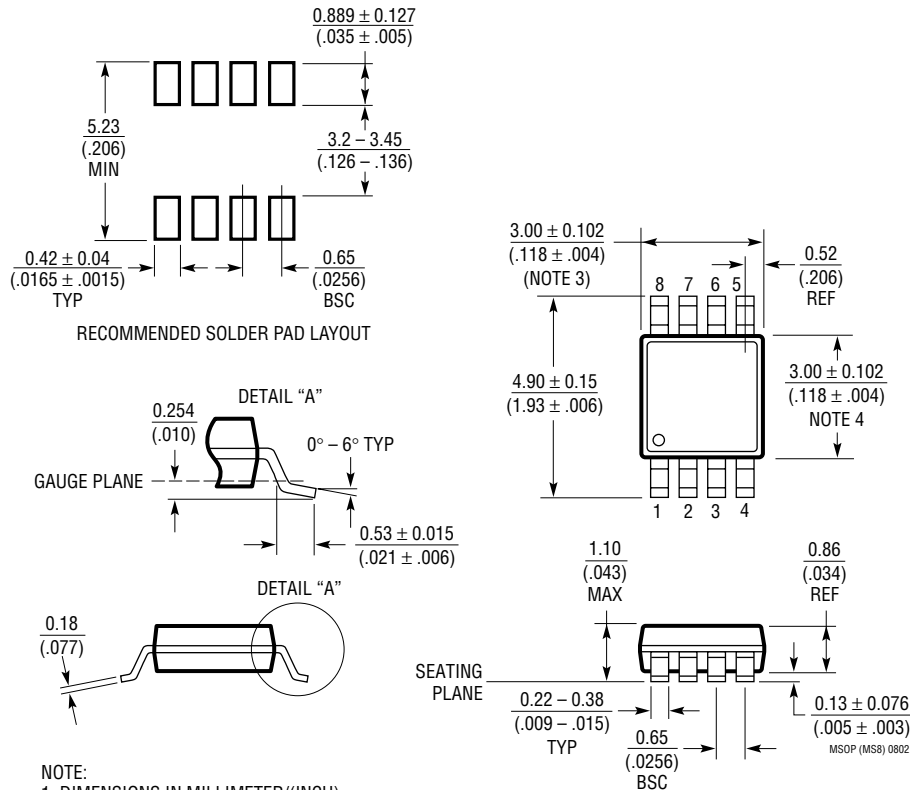

- NOTE:
1. DIMENSIONS IN MILLIMETER/(INCH)
 2. DRAWING NOT TO SCALE
 3. DIMENSION DOES NOT INCLUDE MOLD FLASH, PROTRUSIONS OR GATE BURRS. MOLD FLASH, PROTRUSIONS OR GATE BURRS SHALL NOT EXCEED 0.152mm (.006") PER SIDE
 4. DIMENSION DOES NOT INCLUDE INTERLEAD FLASH OR PROTRUSIONS. INTERLEAD FLASH OR PROTRUSIONS SHALL NOT EXCEED 0.152mm (.006") PER SIDE
 5. LEAD COPLANARITY (BOTTOM OF LEADS AFTER FORMING) SHALL BE 0.102mm (.004") MAX

PACKAGE DESCRIPTION

S8 Package
8-Lead Plastic Small Outline (Narrow .150 Inch)
 (Reference LTC DWG # 05-08-1610)

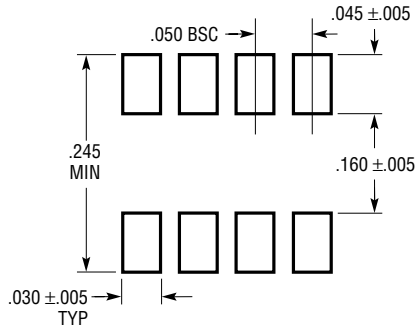

RECOMMENDED SOLDER PAD LAYOUT

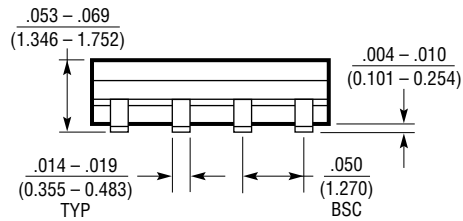
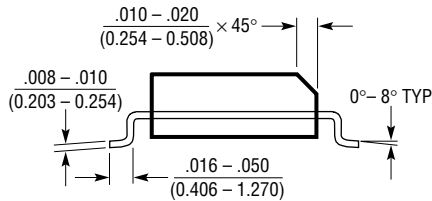
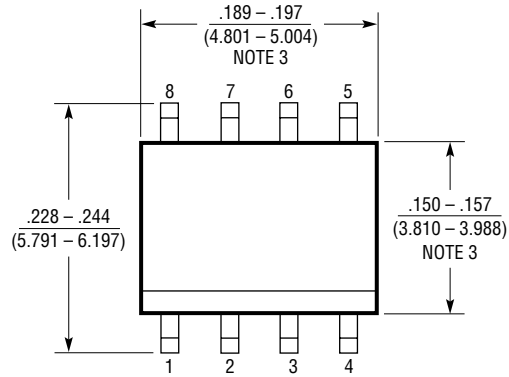

- NOTE:
 1. DIMENSIONS IN $\frac{\text{INCHES}}{\text{MILLIMETERS}}$
 2. DRAWING NOT TO SCALE
 3. THESE DIMENSIONS DO NOT INCLUDE MOLD FLASH OR PROTRUSIONS.
 MOLD FLASH OR PROTRUSIONS SHALL NOT EXCEED .006" (0.15mm)

S08 0303

PACKAGE DESCRIPTION

S Package 14-Lead Plastic Small Outline (Narrow .150 Inch) (Reference LTC DWG # 05-08-1610)

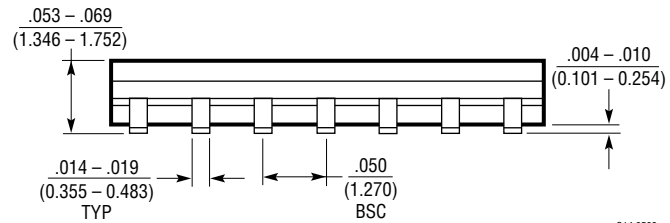
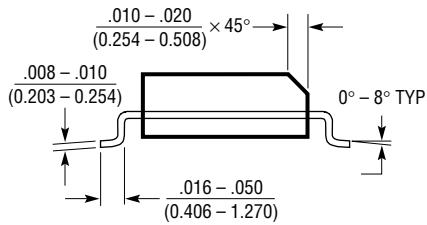
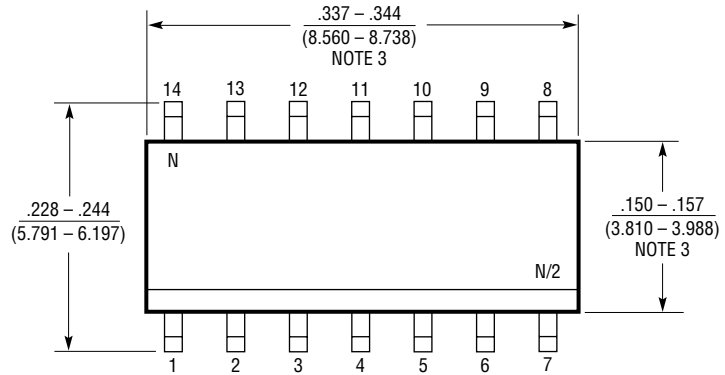
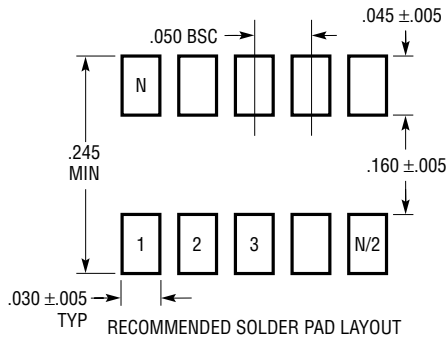

- NOTE:
 1. DIMENSIONS IN $\frac{\text{INCHES}}{\text{MILLIMETERS}}$
 2. DRAWING NOT TO SCALE
 3. THESE DIMENSIONS DO NOT INCLUDE MOLD FLASH OR PROTRUSIONS.
 MOLD FLASH OR PROTRUSIONS SHALL NOT EXCEED $.006''$ (0.15mm)

S14 0502

PACKAGE DESCRIPTION

S5 Package
5-Lead Plastic TSOT-23
 (Reference LTC DWG # 05-08-1635)

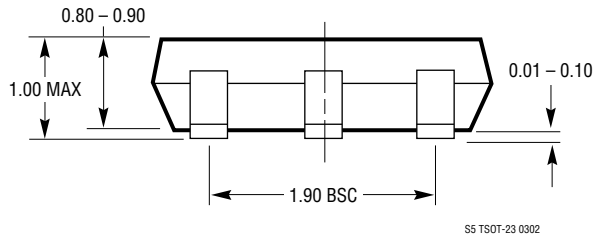
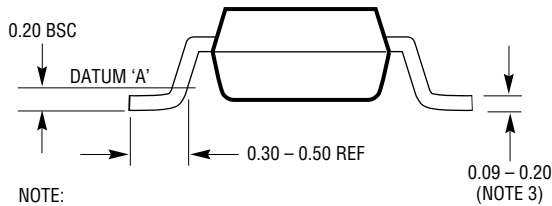
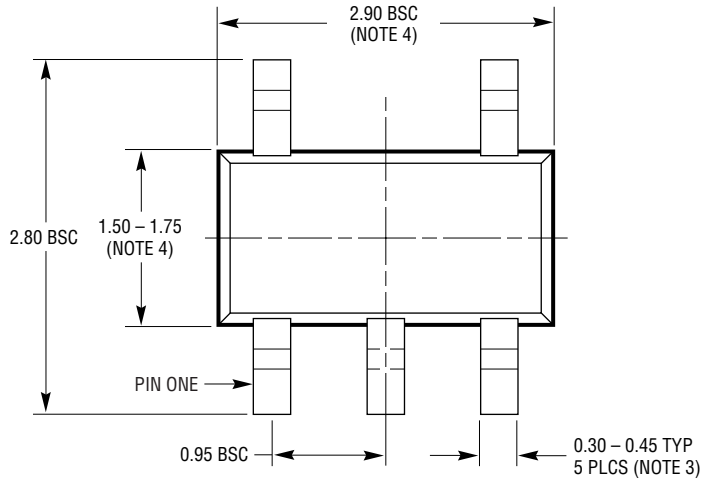
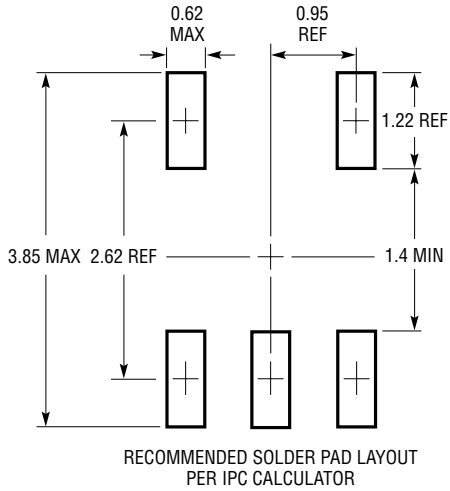

- NOTE:
1. DIMENSIONS ARE IN MILLIMETERS
 2. DRAWING NOT TO SCALE
 3. DIMENSIONS ARE INCLUSIVE OF PLATING
 4. DIMENSIONS ARE EXCLUSIVE OF MOLD FLASH AND METAL BURR
 5. MOLD FLASH SHALL NOT EXCEED 0.254mm
 6. JEDEC PACKAGE REFERENCE IS MO-193

S5 TSOT-23 0302

TYPICAL APPLICATION

Low Noise Differential Amplifier with Gain Adjust and Common Mode Control

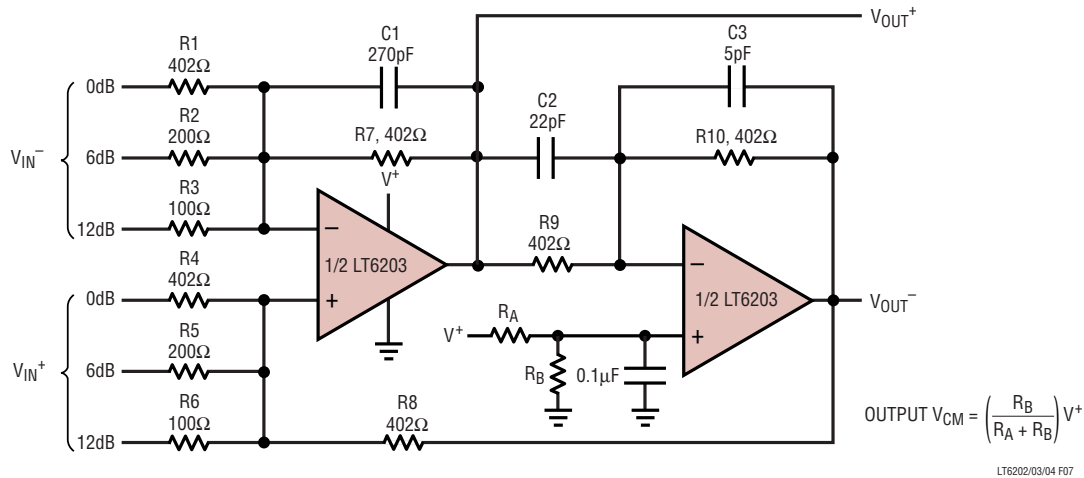

Low Noise Differential Amplifier Frequency Response

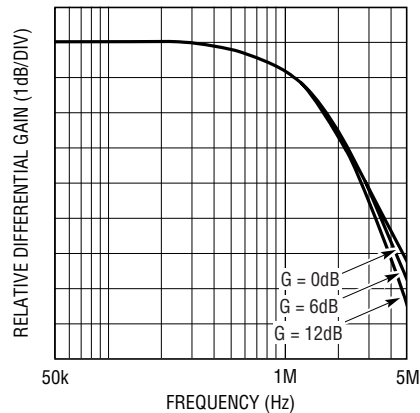

RELATED PARTS

PART NUMBER	DESCRIPTION	COMMENTS
LT1028	Single, Ultralow Noise 50MHz Op Amp	1.1nV/ $\sqrt{\text{Hz}}$
LT1677	Single, Low Noise Rail-to-Rail Amplifier	3V Operation, 2.5mA, 4.5nV/ $\sqrt{\text{Hz}}$, 60 μV Max V_{OS}
LT1722/LT1723/LT1724	Single/Dual/Quad Low Noise Precision Op Amps	70V/ μs Slew Rate, 400 μV Max V_{OS} , 3.8nV/ $\sqrt{\text{Hz}}$, 3.7mA
LT1800/LT1801/LT1802	Single/Dual/Quad Low Power 80MHz Rail-to-Rail Op Amps	8.5nV/ $\sqrt{\text{Hz}}$, 2mA Max Supply
LT1806/LT1807	Single/Dual, Low Noise 325MHz Rail-to-Rail Amplifiers	2.5V Operation, 550 μV Max V_{OS} , 3.5nV/ $\sqrt{\text{Hz}}$
LT6200	Single Ultralow Noise Rail-to-Rail Amplifier	0.95nV/ $\sqrt{\text{Hz}}$, 165MHz Gain Bandwidth