

# NON-ISOLATED DC/DC CONVERTERS

3 Vdc – 14.4 Vdc Input, 0.6 Vdc - 5.5 Vdc /3 A Outputs



Jul. 13, 2015

Bel Power Inc., a subsidiary of Bel Fuse Inc.

SLAN-03D2Ax

RoHS Compliant

Rev.B

## Features

- Non-Isolated
- Power Good signal
- Remote On/Off
- Overtemperature protection
- Compliant to IPC-9592 (September 2008), Category 2, Class II
- Compliant to RoHS EU Directive 2002/95/EC
- Compatible in a Pb-free or SnPb reflow environment
- Output voltage programmable from 0.6Vdc to 5.5Vdc via external resistor.
- Tunable Loop™ to optimize dynamic output voltage response
- Output overcurrent protection (non-latching)
- Wide operating temperature range [-40°C to 85°C]
- Wide Input voltage range (3Vdc-14.4Vdc). Ref.to Figure 41 for corresponding output range.
- UL60950-1 Recognized (UL/cUL)
- Small size: 12.2mm × 12.2mm × 6.25mm (0.48 in × 0.48 in × 0.246 in)
- ISO 9001 and ISO 14001 certified manufacturing facilities
- Cost efficient open frame design
- Ability to sink and source current
- DOSA based
- Fixed switching frequency

## Applications

- Distributed power architectures
- Intermediate bus voltage applications
- Telecommunications equipment
- Servers and storage applications
- Networking equipment
- Industrial equipment



## Description

The SLAN-03D2Ax modules are non-isolated dc-dc converters that can deliver up to 3A of output current. These modules operate over a wide range of input voltage ( $V_{in} = 3 \text{ Vdc} - 14.4 \text{ Vdc}$ ) and provide a precisely regulated output voltage from 0.6 Vdc to 5.5 Vdc, programmable via an external resistor. Features include remote On/Off, adjustable output voltage, over current and over temperature protection. The Tunable Loop™ feature allows the user to optimize the dynamic response of the converter to match the load with reduced amount of output capacitance leading to savings on cost and PWB area.

## Part Selection

Output Voltage	Input Voltage	Max. Output Current	Max. Output Power	Typical Efficiency	Model Number Active High	Model Number Active Low
0.6 - 5.5 Vdc	3 - 14.4 Vdc	3 A	16.5W	93.9%	SLAN-03D2A0	SLAN-03D2AL

- Notes:**
1. Add "R" suffix at the end of the model number to indicate tape and reel packaging (Standard).
  2. Add "G" suffix at the end of the model number to indicate tray packaging (Option).

# NON-ISOLATED DC/DC CONVERTERS

3 Vdc – 14.4 Vdc Input, 0.6 Vdc - 5.5 Vdc /3 A Outputs



Jul. 13, 2015

Bel Power Inc., a subsidiary of Bel Fuse Inc.

## Ordering Part Number

**S** LAN - 03 **D** 2A 0 x  
 1 2 3 4 5 6 7

1---Surface mount

2---Series code

3---Output current (3A)

4---Wide input voltage range (3-14.4V)

5---Without sequencing

6---Enable, active high, change "0" to "L" means active low

7---Package

## Absolute Maximum Ratings

Parameter	Min	Max	Unit	Notes
Continuous Input Voltage	-0.3	15	V	
Operating Ambient Temperature	-40	85	°C	see Thermal Considerations section
Storage Temperature	-55	125	°C	
Altitude	-	2000	m	

**Note:** Stresses in excess of the absolute maximum ratings can cause permanent damage to the device. These are absolute stress ratings only, functional operation of the device is not implied at these or any other conditions in excess of those given in the operations sections of the data sheet. Exposure to absolute maximum ratings for extended periods can adversely affect the device reliability.

## Input Specifications

Parameter	Min	Typ	Max	Unit	Notes
Operating Input Voltage	3	-	14.4	V	
Input Current (full load)	-	-	2.4	A	$V_{IN}=3V$ to $14V$ , $I_O=I_{Omax}$
Input Current (no load)	-	17	-	mA	$V_{O,set} = 0.6$ Vdc
	-	38	-	mA	$V_{O,set} = 5$ Vdc
Input Stand-by Current	-	0.8	-	mA	$V_{IN} = 12V$ , module disabled
Input Reflected Ripple Current (pk-pk)	-	15	-	mAp-p	5Hz to 20MHz, $1\mu H$ source impedance; $V_{IN} = 0$ to $14V$ , $I_O=I_{Omax}$ ; See Test Configurations
I <sup>2</sup> t Inrush Current Transient	-	-	1	A <sup>2</sup> s	
Input Ripple Rejection (120Hz)	-	-60	-	dB	

**Note:** Unless otherwise indicated, specifications apply over all operating input voltage, resistive load, and temperature conditions.

## Output Specifications

Parameter	Min	Typ	Max	Unit	Notes
Output Voltage Set Point	-1.0	-	+1.0	% $V_{O,set}$	with 0.1% tolerance for external resistor used to set output voltage
Output Voltage	-3.0	-	+3.0	% $V_{O,set}$	Over all operating input voltage, resistive load, and temperature conditions until end of life
Adjustment Range	0.6	-	5.5	V	1. selected by an external resistor. 2. Some output voltages may not be possible depending on the input voltage – see Feature Descriptions Section.
Remote Sense Range	-	-	0.5	V	
Load Regulation	$V_O \geq 2.5V$	-	10	mV	$I_O=I_{O, min}$ to $I_{O, max}$
	$V_O < 2.5V$	-	10	mV	

# NON-ISOLATED DC/DC CONVERTERS

3 Vdc – 14.4 Vdc Input, 0.6 Vdc - 5.5 Vdc /3 A Outputs



Jul. 13, 2015

Bel Power Inc., a subsidiary of Bel Fuse Inc.

## Output Specifications (continued)

Parameter	Min	Typ	Max	Unit	Notes
Line Regulation $V_o \geq 2.5V$ $V_o < 2.5V$	- -	- -	0.4 5	% $V_{o,set}$ mV	$V_{IN}=V_{IN, min}$ to $V_{IN, max}$
Temperature Regulation	-	-	0.4	% $V_{o,set}$	$T_{ref}=T_{A, min}$ to $T_{A, max}$
Ripple and Noise (pk-pk)	-	50	100	mV	5Hz to 20MHz BW, $V_{IN}=V_{IN, nom}$ and $I_o=I_{o, min}$ to $I_{o, max}$ , $C_o = 0.1\mu F // 22 \mu F$ ceramic capacitors)
Ripple and Noise (rms)	-	20	38	mV	
Output Short-Circuit Current	-	0.5	-	A	$V_o \leq 250mV$ , Hiccup Mode
Output Capacitance <sup>1</sup> $ESR \geq 1 m\Omega$ $ESR \geq 0.15 m\Omega$ $ESR \geq 10 m\Omega$	10 10 10	- - -	22 1000 3000	$\mu F$ $\mu F$ $\mu F$	Without the Tunable Loop™ With the Tunable Loop™ With the Tunable Loop™
Output Current	0	-	3	A	In either sink or source mode
Output Current Limit Inception	-	200	-	% $I_{o, max}$	1. Hiccup Mode 2. Current limit does not operate in sink mode
Output voltage overshoot	-	-	3.0	% $V_{o, set}$	$V_{in} = V_{in, min}$ to $V_{in, max}$ , $I_o = I_{o, min}$ to $I_{o, max}$ , $T_A=25^\circ C$ With or without maximum external capacitance
Turn-On Delay Times $(V_{IN}=V_{IN, nom}, I_o=I_{o, max}, V_o$ to within $\pm 1\%$ of steady state)	-	4	-	msec	Case 1: On/Off input is enabled and then input power is applied (delay from instant at which $V_{IN} = V_{IN, min}$ until $V_o = 10\%$ of $V_{o, set}$ )
	-	4.8	-	msec	Case 2: Input power is applied for at least one second and then the On/Off input is enabled (delay from instant at which On/Off is enabled until $V_o = 10\%$ of $V_{o, set}$ )
Output voltage Rise time	-	2.8	-	msec	Time for $V_o$ to rise from 10% of $V_{o, set}$ to 90% of $V_{o, set}$ .

**Notes:** <sup>1</sup> External capacitors may require using the new Tunable Loop™ feature to ensure that the module is stable as well as getting the best transient response. See the Tunable Loop™ section for details.

## General Specifications

Parameter	Min	Typ	Max	Unit	Notes
Efficiency $V_o=0.6V(8Vin)$ $V_o=1.2V$ $V_o=1.8V$ $V_o=2.5V$ $V_o=3.3V$ $V_o=5.0V$	- - - - - -	75.0 82.8 88.2 89.9 91.6 93.9	- - - - - -	% % % % % %	$V_{in} = 12Vdc$ , $T_A=25^\circ C$ $I_o=I_{o, max}$ , $V_o= V_{o, set}$
Switching Frequency	-	600	-	kHz	
Input Undervoltage Lockout					
Turn-on Threshold	-	-	3.0	V	
Turn-off Threshold	-	2.69	-	V	
Hysteresis	-	0.2	-	V	
Over Temperature Protection	-	135	-	$^\circ C$	

**NON-ISOLATED DC/DC CONVERTERS**  
 3 Vdc – 14.4 Vdc Input, 0.6 Vdc - 5.5 Vdc /3 A Outputs



Jul. 13, 2015

*Bel Power Inc., a subsidiary of Bel Fuse Inc.*

**General Specifications(continued)**

Parameter	Min	Typ	Max	Unit	Notes
PGOOD (Power Good)					
Overvoltage threshold for PGOOD	-	112.5	-	%V <sub>O, set</sub>	Signal Interface Open Drain, V <sub>supply</sub> ≤ 5Vdc
Undervoltage threshold for PGOOD	-	87.5	-	%V <sub>O, set</sub>	
Pulldown resistance of PGOOD pin	-	30	-	Ω	
Weight	-	0.89	-	g	
MTBF	19,508,839			hours	Calculated MTBF (I <sub>O</sub> =0.8I <sub>O, max</sub> , T <sub>A</sub> =40°C) Telecordia Issue 2 Method 1 Case 3
Dimensions				-	
Inches (L × W × H)	0.48 x 0.48 x 0.246				
Millimeters (L × W × H)	12.2 x 12.2 x 6.25				

**Note:** Unless otherwise indicated, specifications apply over all operating input voltage, resistive load, and temperature conditions. See Feature Descriptions for additional information.

# NON-ISOLATED DC/DC CONVERTERS

3 Vdc – 14.4 Vdc Input, 0.6 Vdc - 5.5 Vdc /3 A Outputs



Jul. 13, 2015  
Efficiency Data

Bel Power Inc., a subsidiary of Bel Fuse Inc.

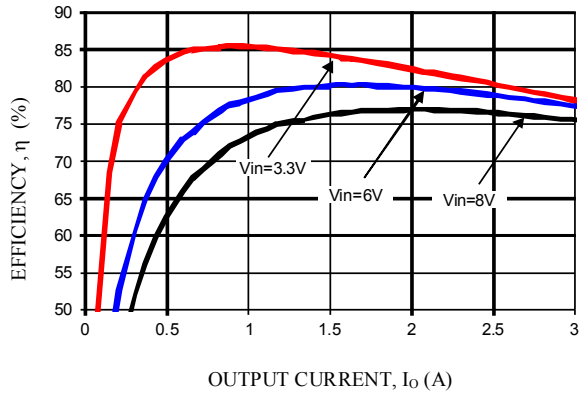

**Vo=0.6V**

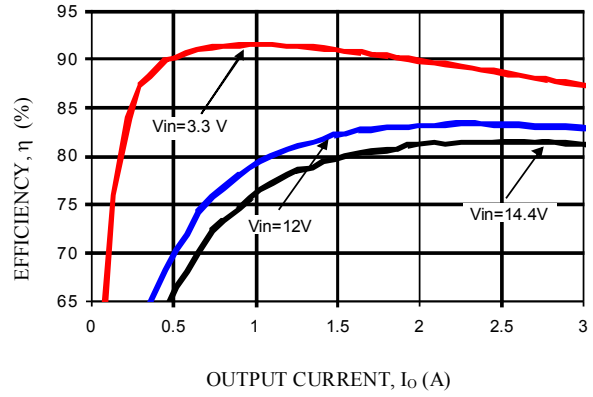

**Vo=1.2V**

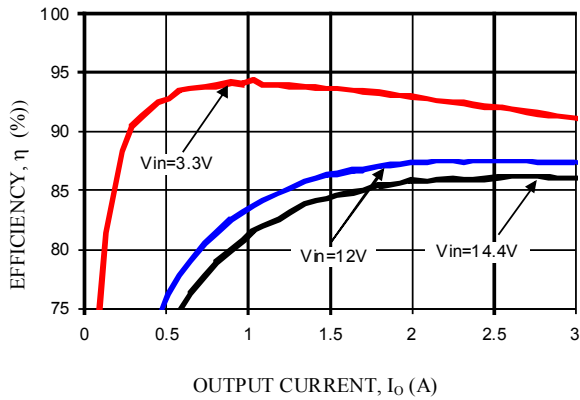

**Vo=1.8V**

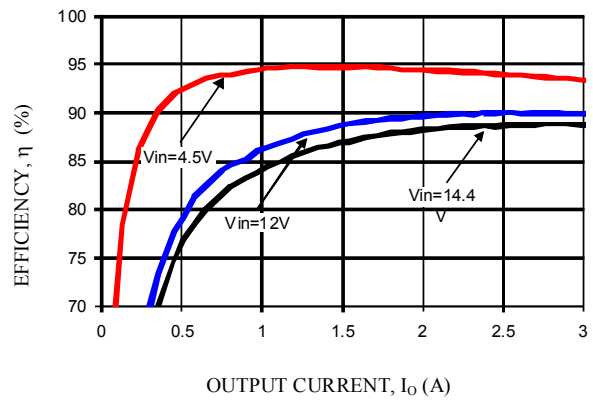

**Vo=2.5V**

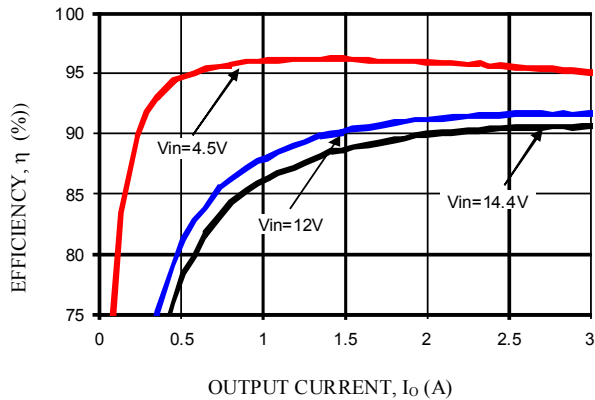

**Vo=3.3V**

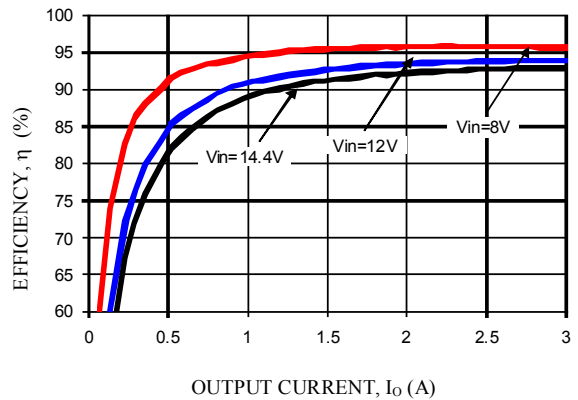

**Vo=5.0V**

# NON-ISOLATED DC/DC CONVERTERS

3 Vdc – 14.4 Vdc Input, 0.6 Vdc - 5.5 Vdc /3 A Outputs



Jul. 13, 2015

Bel Power Inc., a subsidiary of Bel Fuse Inc.

## Thermal Derating Curves

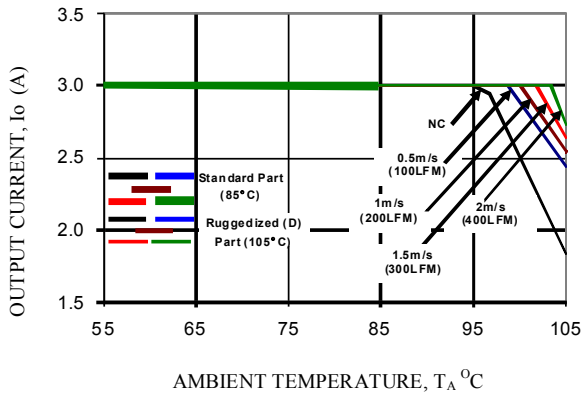

$V_o=0.6V$

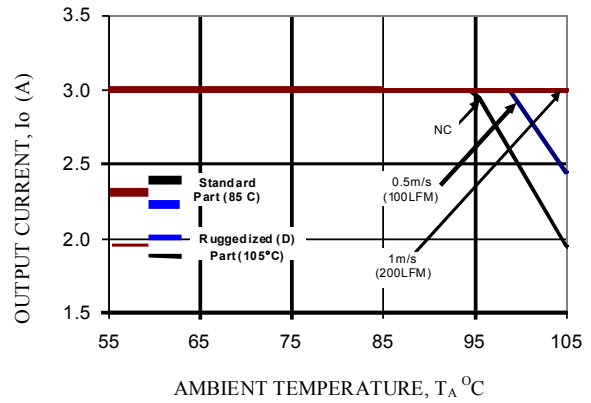

$V_o=1.2V$

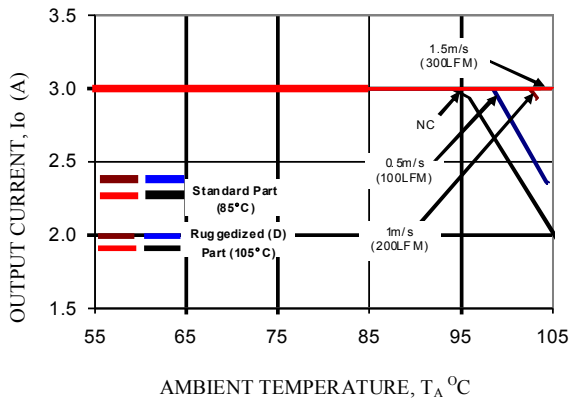

$V_o=1.8V$

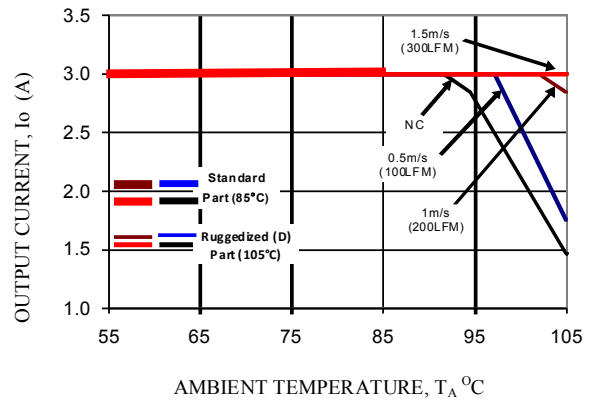

$V_o=2.5V$

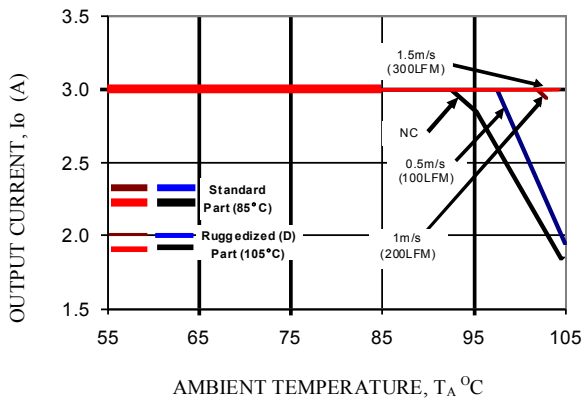

$V_o=3.3V$

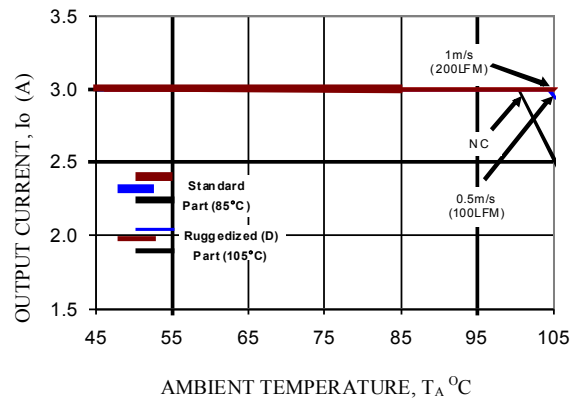

$V_o=5.0V$

# NON-ISOLATED DC/DC CONVERTERS

3 Vdc – 14.4 Vdc Input, 0.6 Vdc - 5.5 Vdc /3 A Outputs



Jul. 13, 2015

Bel Power Inc., a subsidiary of Bel Fuse Inc.

## Output ripple and Noise Waveforms

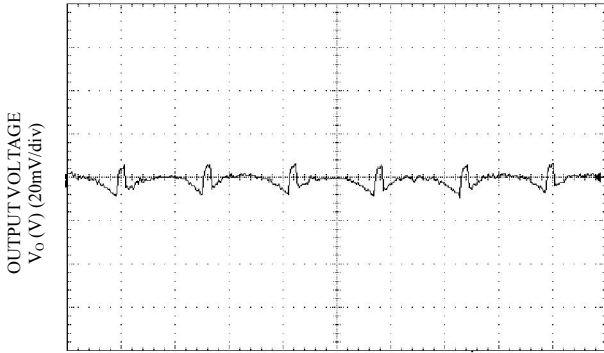

TIME, t (1µs/div)

**Vo=0.6V, Io = Io,max, Vin=8V**

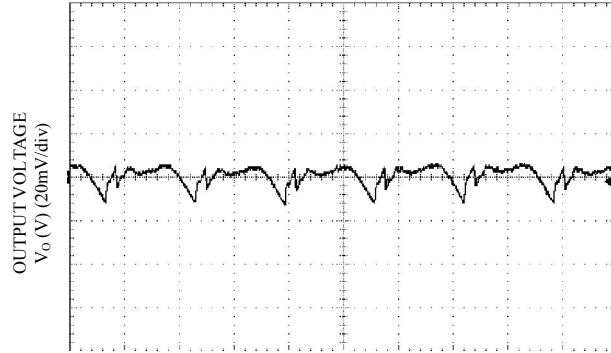

TIME, t (1µs/div)

**Vo=1.2V, Io = Io,max, Vin=12V**

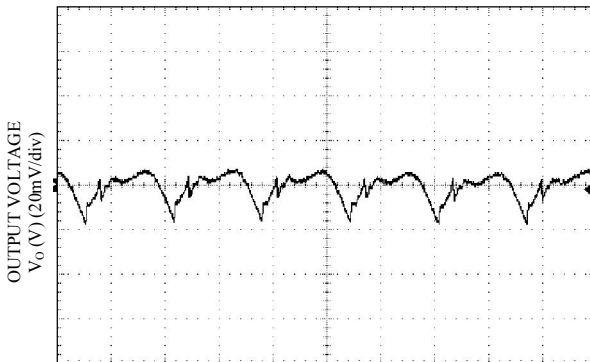

TIME, t (1µs/div)

**Vo=1.8V, Io = Io,max, Vin=12V**

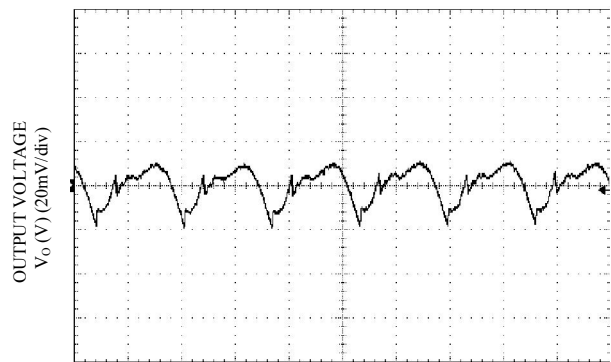

TIME, t (1µs/div)

**Vo=2.5V, Io = Io,max, Vin=12V**

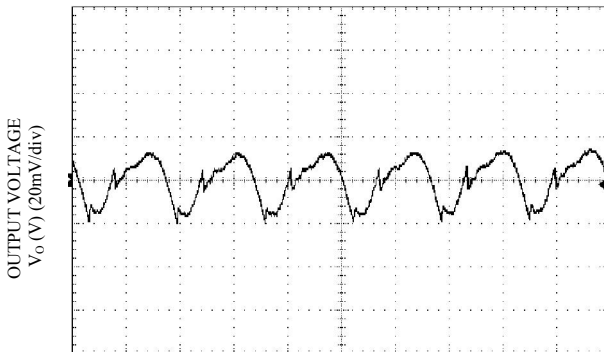

TIME, t (1µs/div)

**Vo=3.3V, Io = Io,max, Vin=12V**

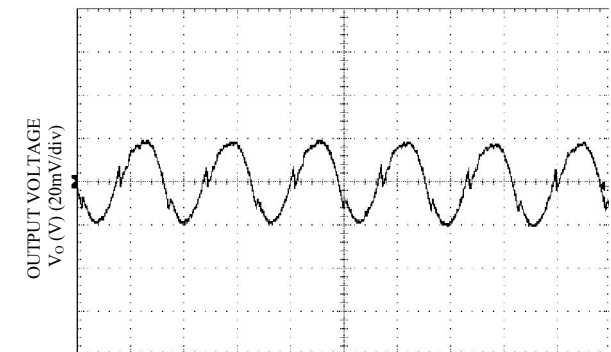

TIME, t (1µs/div)

**Vo=5.0V, Io = Io,max, Vin=12V**

**Note:**  $C_O=10\mu\text{F}$  ceramic

# NON-ISOLATED DC/DC CONVERTERS

3 Vdc – 14.4 Vdc Input, 0.6 Vdc - 5.5 Vdc /3 A Outputs



Jul. 13, 2015

Bel Power Inc., a subsidiary of Bel Fuse Inc.

## Transient Response Waveforms

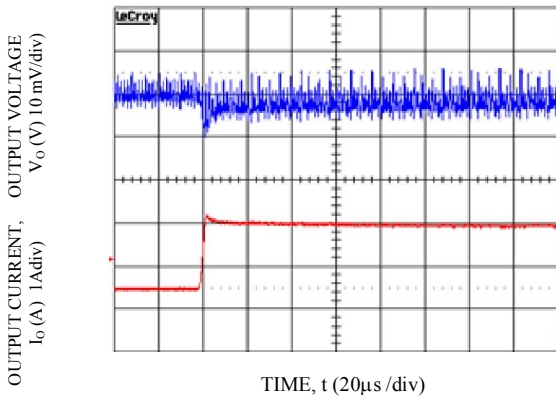

Transient Response to Dynamic Load Change from 50% to 100% at 8Vin, Cout-1x47uF+2x330uF, CTune-27nF, RTune-178. Vo=0.6V

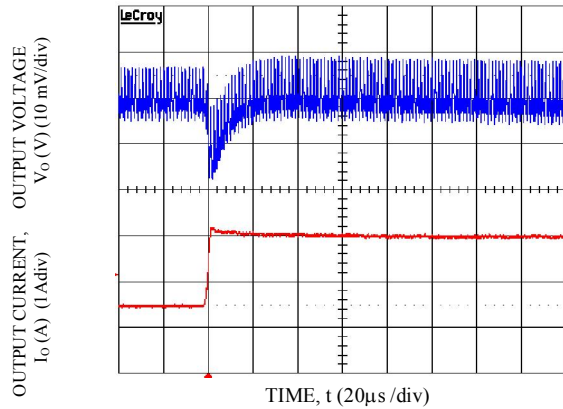

Transient Response to Dynamic Load Change from 50% to 100% at 12Vin, Cout-1x47uF+1x330uF, CTune-10nF & RTune-261. Vo=1.2V

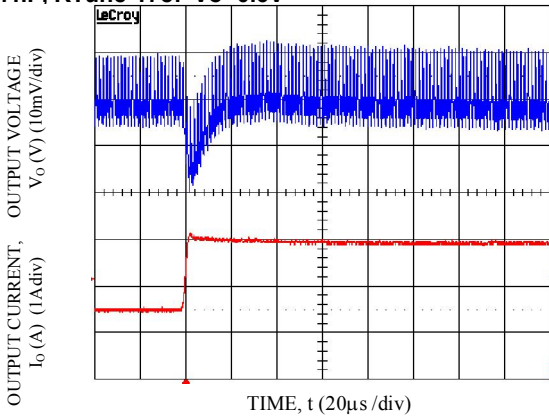

Transient Response to Dynamic Load Change from 50% to 100% at 12Vin, Cout-1x47uF+1x330uF, CTune-10nF & RTune-261. Vo=1.8V

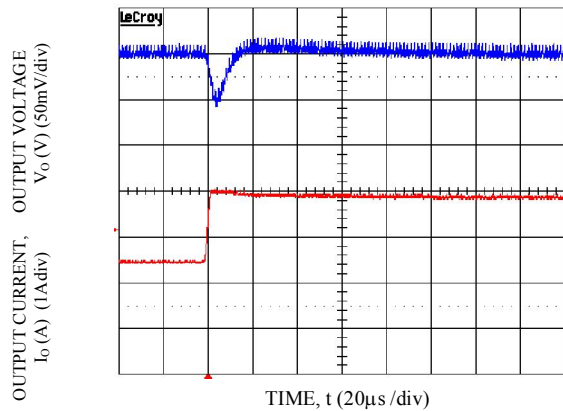

Transient Response to Dynamic Load Change from 50% to 100% at 12Vin, Cout-2x47uF, CTune-2700pF & RTune-261. Vo=2.5V

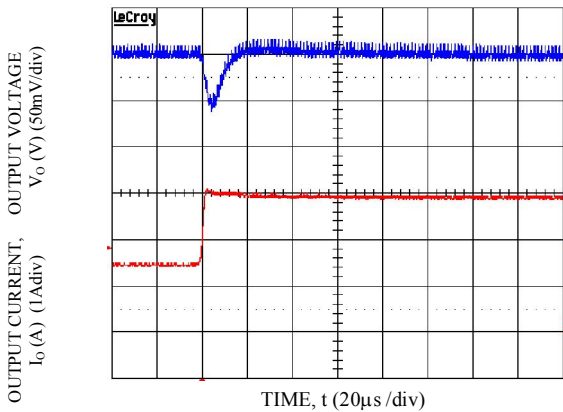

Transient Response to Dynamic Load Change from 50% to 100% at 12Vin, Cout-2x47uF, CTune-2200pF & RTune-261. Vo=3.3V

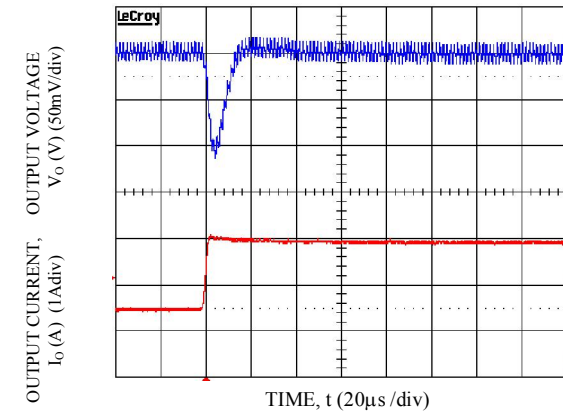

Transient Response to Dynamic Load Change from 50% to 100% at 12Vin, Cout-1x47uF, CTune-820pF & RTune-261. Vo=5V

# NON-ISOLATED DC/DC CONVERTERS

3 Vdc – 14.4 Vdc Input, 0.6 Vdc - 5.5 Vdc /3 A Outputs



Jul. 13, 2015

Bel Power Inc., a subsidiary of Bel Fuse Inc.

## Startup Time

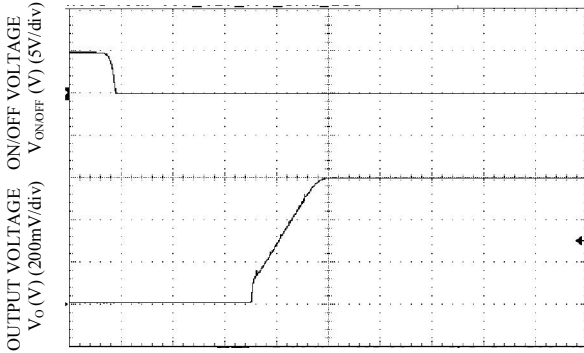

TIME, t (2 ms/div)

Start-up Using On/Off Voltage ( $I_o = I_{o,max}$ ),  $V_o=0.6V$

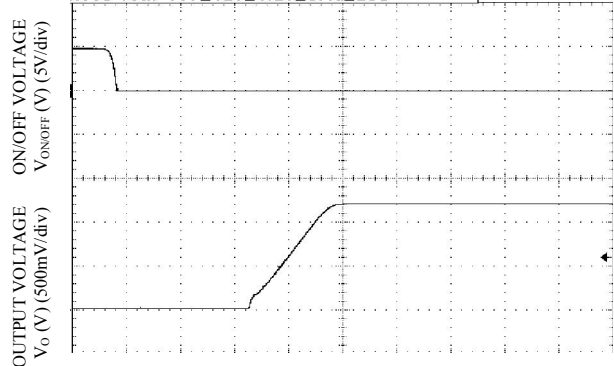

TIME, t (2 ms/div)

Start-up Using On/Off Voltage ( $I_o = I_{o,max}$ ),  $V_o=1.2V$

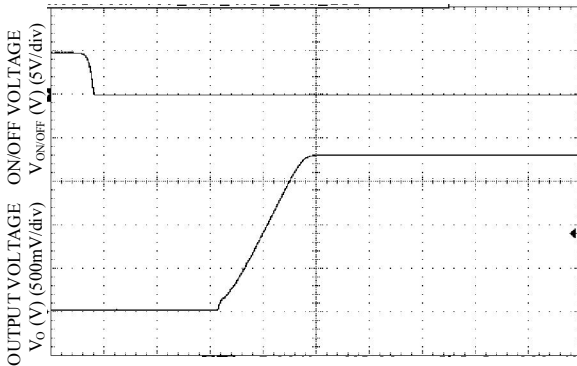

TIME, t (2 ms/div)

Start-up Using On/Off Voltage ( $I_o = I_{o,max}$ ),  $V_o=1.8V$

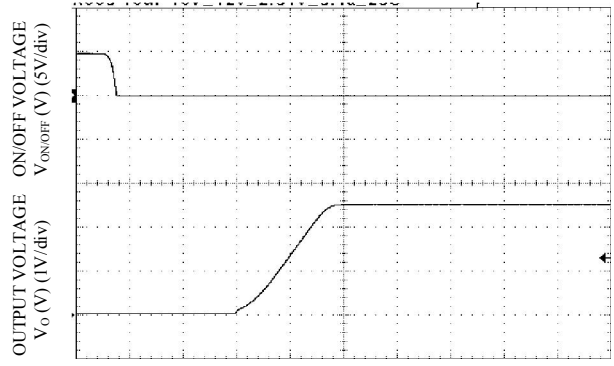

TIME, t (2 ms/div)

Start-up Using On/Off Voltage ( $I_o = I_{o,max}$ ),  $V_o=2.5V$

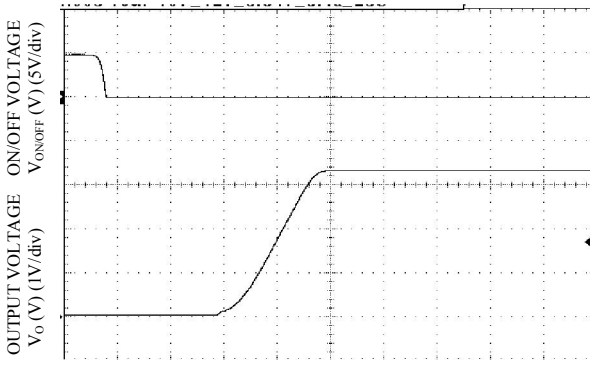

TIME, t (2 ms/div)

Start-up Using On/Off Voltage ( $I_o = I_{o,max}$ ),  $V_o=3.3V$

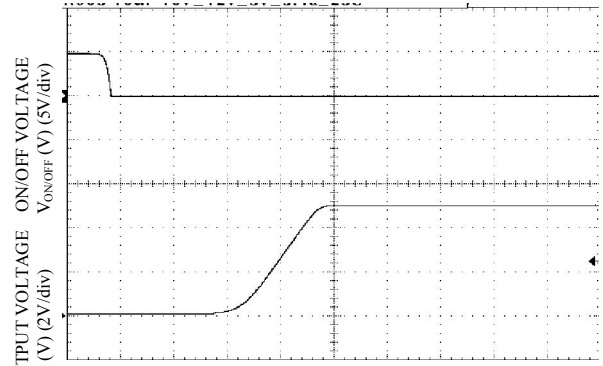

TIME, t (2 ms/div)

Start-up Using On/Off Voltage ( $I_o = I_{o,max}$ ),  $V_o=5.0V$

# NON-ISOLATED DC/DC CONVERTERS

3 Vdc – 14.4 Vdc Input, 0.6 Vdc - 5.5 Vdc /3 A Outputs



Jul. 13, 2015

Bel Power Inc., a subsidiary of Bel Fuse Inc.

## Startup Time (continued)

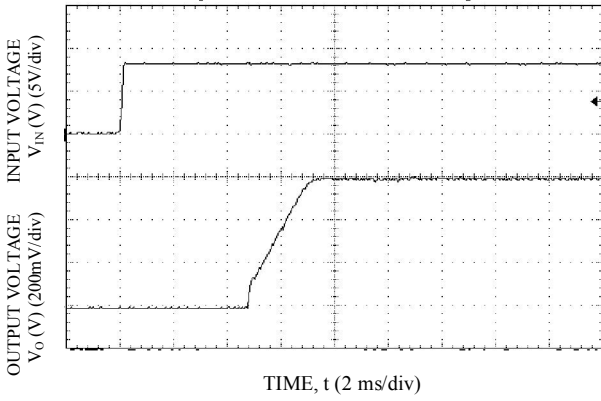

TIME, t (2 ms/div)  
**Start-up Using Input Voltage ( $V_{IN} = 8V$ ,  $I_o = I_{o,max}$ ),  
 $V_o = 0.6V$**

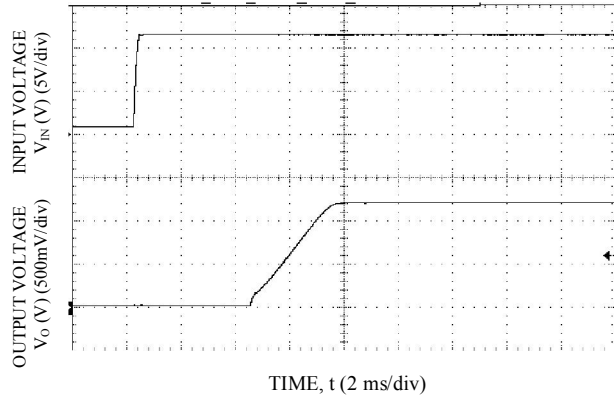

TIME, t (2 ms/div)  
**Start-up Using Input Voltage ( $V_{IN} = 12V$ ,  $I_o = I_{o,max}$ ),  
 $V_o = 1.2V$**

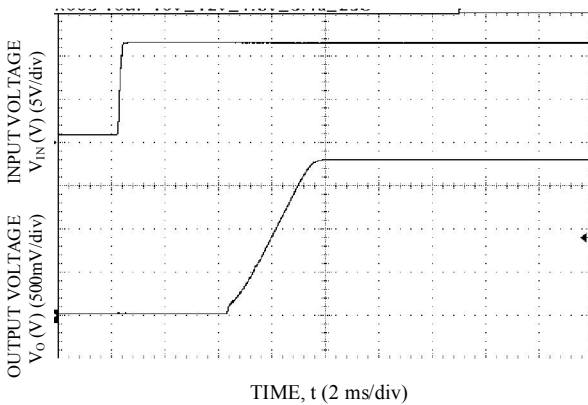

TIME, t (2 ms/div)  
**Start-up Using Input Voltage ( $V_{IN} = 12V$ ,  $I_o = I_{o,max}$ ),  
 $V_o = 1.8V$**

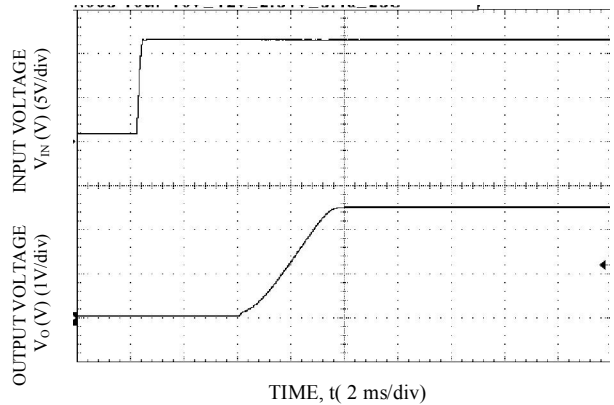

TIME, t (2 ms/div)  
**Start-up Using Input Voltage ( $V_{IN} = 12V$ ,  $I_o = I_{o,max}$ ),  
 $V_o = 2.5V$**

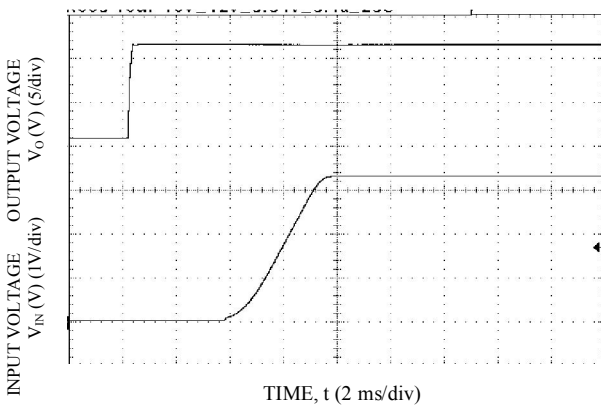

TIME, t (2 ms/div)  
**Start-up Using Input Voltage ( $V_{IN} = 12V$ ,  $I_o = I_{o,max}$ ),  
 $V_o = 3.3V$**

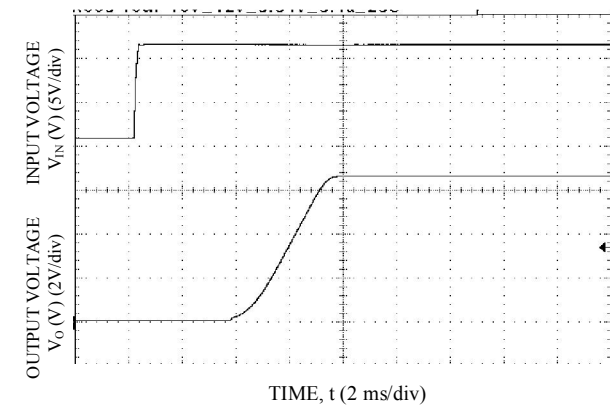

TIME, t (2 ms/div)  
**Start-up Using Input Voltage ( $V_{IN} = 12V$ ,  $I_o = I_{o,max}$ ),  
 $V_o = 5.0V$**

## Design Considerations

### Input Filtering

The SLAN-03D2Ax module should be connected to a low ac-impedance source. A highly inductive source can affect the stability of the module. An input capacitance must be placed directly adjacent to the input pin of the module, to minimize input ripple voltage and ensure module stability.

To minimize input voltage ripple, ceramic capacitors are recommended at the input of the module. Figure 37 shows the input ripple voltage for various output voltages at 3A of load current with 1x22 $\mu$ F or 2x22 $\mu$ F ceramic capacitors and an input of 12V.  
Figure 37

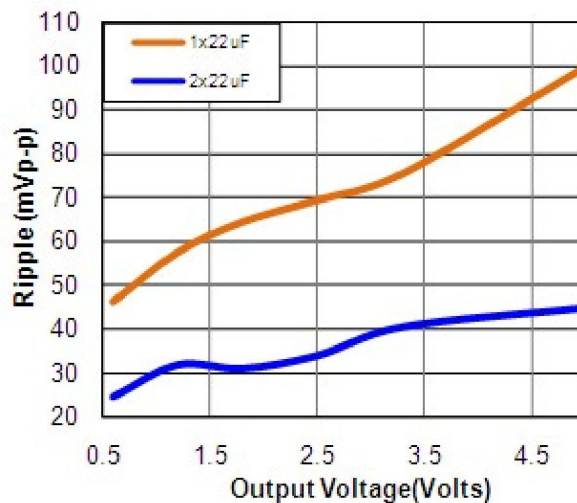

**Note:** Input ripple voltage for various output voltages with 1x22  $\mu$ F or 2x22  $\mu$ F ceramic capacitors at the input (3A load). Input voltage is 12V.

### Output Filtering

These modules are designed for low output ripple voltage and will meet the maximum output ripple specification with 0.1  $\mu$ F ceramic and 10  $\mu$ F ceramic capacitors at the output of the module. However, additional output filtering may be required by the system designer for a number of reasons. First, there may be a need to further reduce the output ripple and noise of the module. Second, the dynamic response characteristics may need to be customized to a particular load step change.

To reduce the output ripple and improve the dynamic response to a step load change, additional capacitance at the output can be used. Low ESR polymer and ceramic capacitors are recommended to improve the dynamic response of the module. Figure 38 provides output ripple information for different external capacitance values at various  $V_o$  and a full load current of 3A. For stable operation of the module, limit the capacitance to less than the maximum output capacitance as specified in the electrical specification table. Optimal performance of the module can be achieved by using the Tunable Loop™ feature described later in this data sheet.

## NON-ISOLATED DC/DC CONVERTERS

3 Vdc – 14.4 Vdc Input, 0.6 Vdc - 5.5 Vdc /3 A Outputs



Jul. 13, 2015

*Bel Power Inc., a subsidiary of Bel Fuse Inc.*

### Output Filtering (continued)

Figure 38

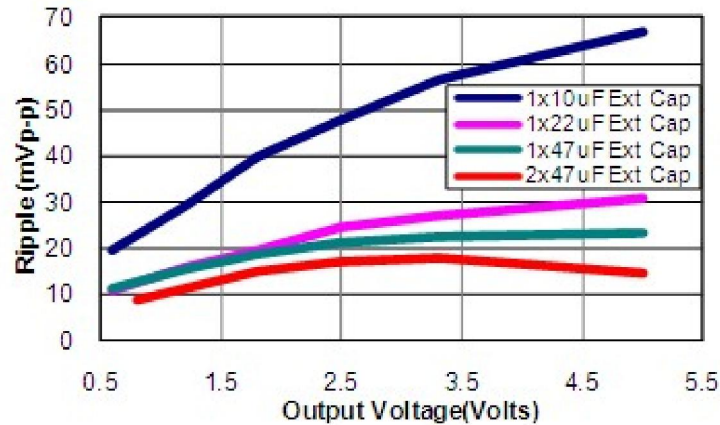

**Note:** Output ripple voltage for various output voltages with external 1x10uF, 1x22uF, 1x47uF and 2x47uF ceramic capacitors at the output (3A load). Input voltage is 12V.

### Safety Considerations

For safety agency approval the power module must be installed in compliance with the spacing and separation requirements of the end-use safety agency standards, i.e., UL 60950-1 2nd, CSA C22.2 No. 60950-1-07, DIN EN 60950-1:2006 + A11 (VDE0805 Teil 1 + A11):2009-11; EN 60950-1:2006 + A11:2009-03.

For the converter output to be considered meeting the requirements of safety extra-low voltage (SELV), the input must meet SELV requirements. The power module has extra-low voltage (ELV) outputs when all inputs are ELV.

The input to these units is to be provided with a fast-acting fuse with a maximum rating of 5A, 125Vdc in the positive input lead.

# NON-ISOLATED DC/DC CONVERTERS

3 Vdc – 14.4 Vdc Input, 0.6 Vdc - 5.5 Vdc /3 A Outputs



Jul. 13, 2015

Bel Power Inc., a subsidiary of Bel Fuse Inc.

## Feature Descriptions

### Remote On/Off

Parameter		Min	Typ	Max	Unit	Notes
Signal Low (Unit On)	Active Low	-0.2	-	0.4	V	The remote on/off pin open, Unit off.
Signal High (Unit Off)		3.0	-	$V_{in,max}$	V	
Signal Low (Unit Off)	Active High	-0.2	-	0.3	V	The remote on/off pin open, Unit on.
Signal High (Unit On)		3.0	-	$V_{in,max}$	V	

The SLAN-03D2Ax power modules feature an On/Off pin for remote On/Off operation. Two On/Off logic options are available. In the Positive Logic On/Off option, (device code suffix “0” – see Ordering Information), the module turns ON during a logic High on the On/Off pin and turns OFF during a logic Low. With the Negative Logic On/Off option, (device code suffix “L” – see Ordering Information), the module turns OFF during logic High and ON during logic Low. The On/Off signal should be always referenced to ground. For either On/Off logic option, leaving the On/Off pin disconnected will turn the module ON when input voltage is present.

For positive logic modules, the circuit configuration for using the On/Off pin is shown in Figure 39. When the external transistor Q1 is in the OFF state, the internal PWM Enable signal is pulled high through an internal resistor and the external pullup resistor and the module is ON. When transistor Q1 is turned ON, the On/Off pin is pulled low and the module is OFF. A suggested value for  $R_{pullup}$  is 20k $\Omega$ .

Figure 39

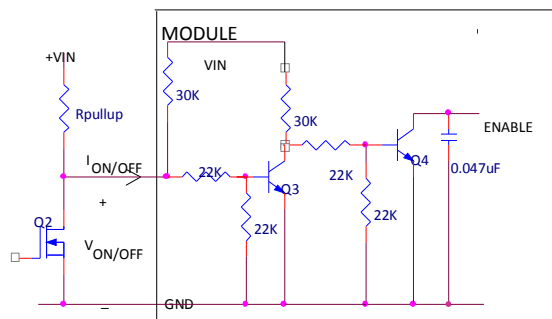

Circuit configuration for using positive On/Off logic.

For negative logic On/Off modules, the circuit configuration is shown in Fig. 40. The On/Off pin should be pulled high with an external pull-up resistor (suggested value for the 3V to 14.4V input range is 20k $\Omega$ ). When transistor Q1 is in the OFF state, the On/Off pin is pulled high, internal transistor Q4 is turned ON and the module is OFF. To turn the pin the module ON, Q1 is turned ON pulling the On/Off pin low, turning transistor Q4 OFF resulting in the PWM Enable pin going high and the module turning ON.

Figure 40

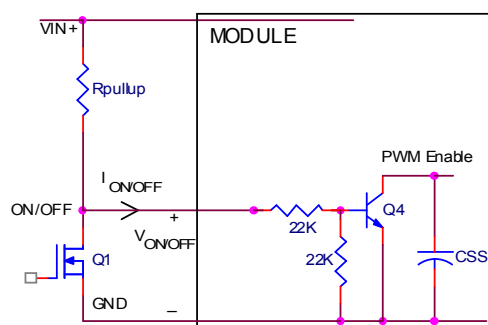

Circuit configuration for using negative On/Off logic.

### Monotonic Start-up and Shutdown

The SLAN-03D2Ax has monotonic start-up and shutdown behavior for any combination of rated input voltage, output current and operating temperature range.

### Startup into Pre-biased Output

The SLAN-03D2Ax can start into a prebiased output as long as the prebias voltage is 0.5V less than the set output voltage.

### Output Voltage Programming

The output voltage of the module is programmable to any voltage from 0.6dc to 5.5Vdc by connecting a resistor between the Trim and GND pins of the module. Certain restrictions apply on the output voltage set point depending on the input voltage. These are shown in the Output Voltage vs. Input Voltage Set Point Area plot in Fig. 41. The Upper Limit curve shows that for output voltages lower than 1V, the input voltage must be lower than the maximum of 12V. The Lower Limit curve shows that for output voltages higher than 0.6V, the input voltage needs to be larger than the minimum of 3V.

Figure 41

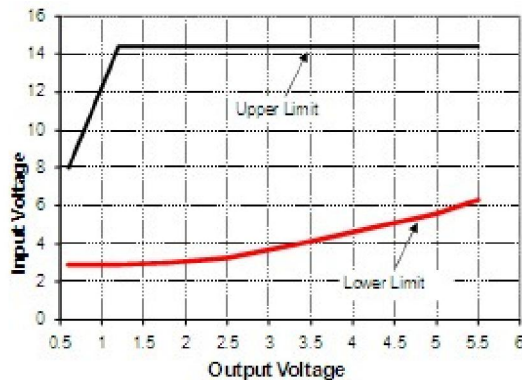

Output Voltage vs. Input Voltage Set Point Area plot showing limits where the output voltage can be set for different input voltages.

Figure 42

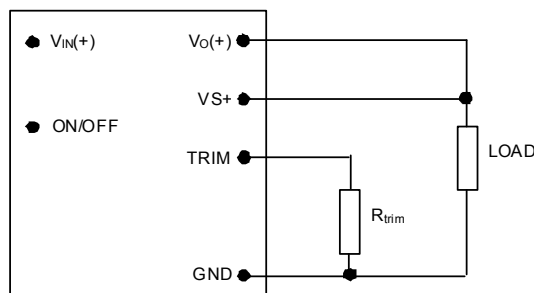

Circuit configuration for programming output voltage using an external resistor.

# NON-ISOLATED DC/DC CONVERTERS

3 Vdc – 14.4 Vdc Input, 0.6 Vdc - 5.5 Vdc /3 A Outputs



Jul. 13, 2015

*Bel Power Inc., a subsidiary of Bel Fuse Inc.*

## Output Voltage Programming(continued)

Without an external resistor between Trim and GND pins, the output of the module will be 0.6Vdc. To calculate the value of the trim resistor,  $R_{trim}$  for a desired output voltage, should be as per the following equation:

$$R_{trim} = \left[ \frac{12}{(V_o - 0.6)} \right] k\Omega$$

$R_{trim}$  is the external resistor in  $k\Omega$   
 $V_o$  is the desired output voltage.

Table1

$V_{o, set}$ (V)	$R_{trim}$ (K $\Omega$ )
0.6	Open
0.9	40
1.0	30
1.2	20
1.5	13.33
1.8	10
2.5	6.316
3.3	4.444
5.0	2.727

## Remote Sense

The power module has a Remote Sense feature to minimize the effects of distribution losses by regulating the voltage at the SENSE pin. The voltage between the SENSE pin and VOUT pin should not exceed 0.5V.

## Voltage Margining

Output voltage margining can be implemented in the module by connecting a resistor,  $R_{margin-up}$ , from the Trim pin to the ground pin for margining-up the output voltage and by connecting a resistor,  $R_{margin-down}$ , from the Trim pin to output pin for margining-down. Figure 43 shows the circuit configuration for output voltage margining. Please consult your local Bel Power technical representative for additional details.

Figure 43

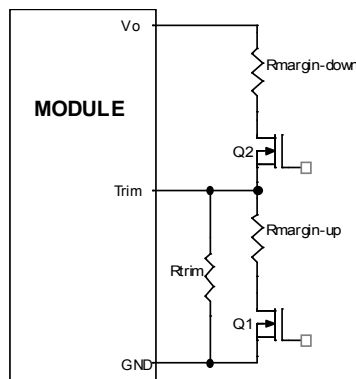

Circuit Configuration for margining Output voltage.

### Overcurrent Protection

To provide protection in a fault (output overload) condition, the unit is equipped with internal current-limiting circuitry and can endure current limiting continuously. At the point of current-limit inception, the unit enters hiccup mode. The unit operates normally once the output current is brought back into its specified range.

### Overtemperature Protection

To provide protection in a fault condition, the unit is equipped with a thermal shutdown circuit. The unit will shutdown if the overtemperature threshold of 135°C(typ) is exceeded at the thermal reference point  $T_{ref}$ . Once the unit goes into thermal shutdown it will then wait to cool before attempting to restart.

### Input Undervoltage Lockout

At input voltages below the input undervoltage lockout limit, the module operation is disabled. The module will begin to operate at an input voltage above the undervoltage lockout turn-on threshold.

### Power Good

The SLAN-03D2Ax provides a Power Good (PGOOD) signal that is implemented with an open-drain output to indicate that the output voltage is within the regulation limits of the power module. The PGOOD signal will be de-asserted to a low state if any condition such as overtemperature, overcurrent or loss of regulation occurs that would result in the output voltage going  $\pm 10\%$  outside the setpoint value. The PGOOD terminal can be connected through a pullup resistor (suggested value 100K $\Omega$ ) to a source of 5VDC or lower.

### Dual Layout

Identical dimensions and pin layout of Analog and Digital modules permit migration from one to the other without needing to change the layout. To support this, 2 separate Trim Resistor locations have to be provided in the layout. For the digital modules, the resistor is connected between the TRIM pad and SGND and in the case of the analog module it is connected between TRIM and GND.

Figure 44

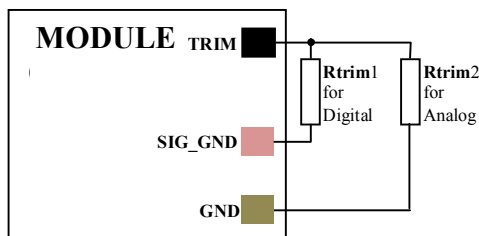

**Caution** – Do not connect SIG\_GND to GND elsewhere in the layout  
Layout to support either Analog or Digital on the same pad.

# NON-ISOLATED DC/DC CONVERTERS

3 Vdc – 14.4 Vdc Input, 0.6 Vdc - 5.5 Vdc /3 A Outputs



Jul. 13, 2015  
Tunable Loop™

Bel Power Inc., a subsidiary of Bel Fuse Inc.

The SLAN-03D2Ax modules have a feature that optimizes transient response of the module called Tunable Loop™.

External capacitors are usually added to the output of the module for two reasons: to reduce output ripple and noise (see Figure 38) and to reduce output voltage deviations from the steady-state value in the presence of dynamic load current changes. Adding external capacitance however affects the voltage control loop of the module, typically causing the loop to slow down with sluggish response. Larger values of external capacitance could also cause the module to become unstable.

The Tunable Loop™ allows the user to externally adjust the voltage control loop to match the filter network connected to the output of the module. The Tunable Loop™ is implemented by connecting a series R-C between the SENSE and TRIM pins of the module, as shown in Fig. 45. This R-C allows the user to externally adjust the voltage loop feedback compensation of the module.

Figure 45

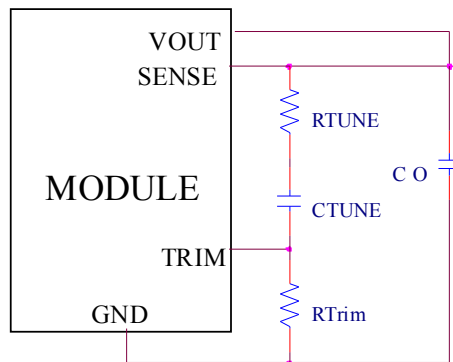

Circuit diagram showing connection of  $R_{TUNE}$  and  $C_{TUNE}$  to tune the control loop of the module.

Recommended values of  $R_{TUNE}$  and  $C_{TUNE}$  for different output capacitor combinations are given in Tables 2 and 3. Table 2 shows the recommended values of  $R_{TUNE}$  and  $C_{TUNE}$  for different values of ceramic output capacitors up to 1000uF that might be needed for an application to meet output ripple and noise requirements. Selecting  $R_{TUNE}$  and  $C_{TUNE}$  according to Table 2 will ensure stable operation of the module.

In applications with tight output voltage limits in the presence of dynamic current loading, additional output capacitance will be required. Table 3 lists recommended values of  $R_{TUNE}$  and  $C_{TUNE}$  in order to meet 2% output voltage deviation limits for some common output voltages in the presence of a 1.5A to 3A step change (50% of full load), with an input voltage of 12V.

Please contact your Bel Power technical representative to obtain more details of this feature as well as for guidelines on how to select the right value of external R-C to tune the module for best transient performance and stable operation for other output capacitance values or input voltages other than 12V.

Table 2

Co	1x47µF	2x47µF	4x47µF	6x47µF	10x47µF
$R_{TUNE}$	270	220	180	180	180
$C_{TUNE}$	1500pF	1800pF	3300pF	4700pF	4700pF

General recommended values of  $R_{TUNE}$  and  $C_{TUNE}$  for  $V_{in}=12V$  and various external ceramic capacitor combinations.

# NON-ISOLATED DC/DC CONVERTERS

3 Vdc – 14.4 Vdc Input, 0.6 Vdc - 5.5 Vdc /3 A Outputs



Jul. 13, 2015

*Bel Power Inc., a subsidiary of Bel Fuse Inc.*

## Tunable Loop™(continued)

Table 3

Vo	5V	3.3V	2.5V	1.8V	1.2V	0.6V
Co	1x47µF	1x47µF	2x47µF	1x330µF Polymer	1x330µF Polymer	2x330µF Polymer
R <sub>TUNE</sub>	270	220	180	180	180	180
C <sub>TUNE</sub>	1500pF	1800pF	3300pF	8200pF	8200pF	33nF
ΔV	68mV	60mV	37mV	18mV	18mV	10mV

Recommended values of R<sub>TUNE</sub> and C<sub>TUNE</sub> to obtain transient deviation of 2% of Vout for a 1.5A step load with Vin=12V.

**Note:** The capacitors used in the Tunable Loop tables are 47 µF/3 mΩ ESR ceramic and 330 µF/12 mΩ ESR polymer capacitors.

## Thermal Consideration

Power modules operate in a variety of thermal environments; however, sufficient cooling should always be provided to help ensure reliable operation.

Considerations include ambient temperature, airflow, module power dissipation, and the need for increased reliability. A reduction in the operating temperature of the module will result in an increase in reliability. The thermal data presented here is based on physical measurements taken in a wind tunnel. The test set-up is shown in Figure 46. The preferred airflow direction for the module is in Figure 47.

Figure 46

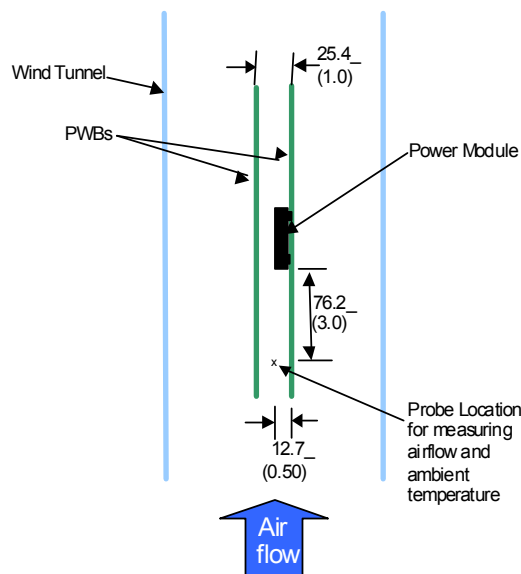

## Thermal Test Setup

The thermal reference points, T<sub>ref</sub> used in the specifications are also shown in Figure 47. For reliable operation the temperatures at these points should not exceed 120°C. The output power of the module should not exceed the rated power of the module (Vo,set x Io,max).

# NON-ISOLATED DC/DC CONVERTERS

3 Vdc – 14.4 Vdc Input, 0.6 Vdc - 5.5 Vdc /3 A Outputs



Jul. 13, 2015

Bel Power Inc., a subsidiary of Bel Fuse Inc.

## Thermal Consideration(continued)

Figure 47

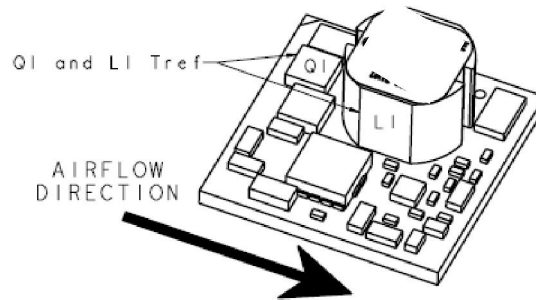

Preferred airflow direction and location of hot-spot of the module (Tref).

## Example Application Circuit

Requirements:

- Vin: 12V
- Vout: 1.8V
- Iout: 2.25A max., worst case load transient is from 1.5A to 2.25A
- $\Delta V_{out}$ : 1.5% of Vout (27mV) for worst case load transient
- Vin, ripple: 1.5% of Vin (180mV, p-p)

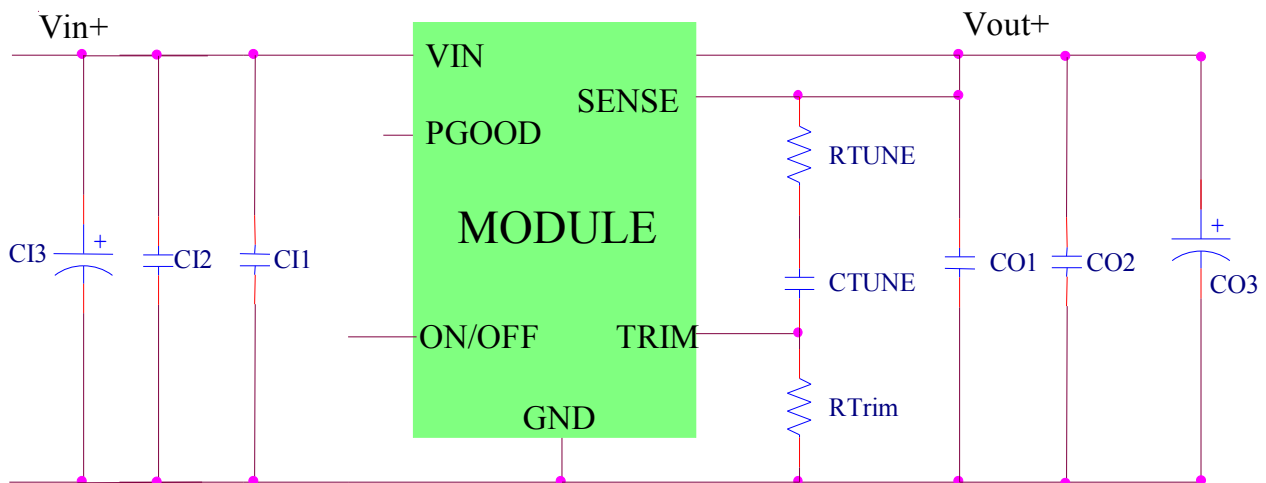

- C11 Decoupling cap - 1x0.047 $\mu$ F/16V ceramic capacitor (e.g. Murata LLL185R71C473MA01)
- C12 1x22 $\mu$ F/16V ceramic capacitor (e.g. Murata GRM32ER61C226KE20 or equivalent)
- C13 47 $\mu$ F/16V bulk electrolytic
- CO1 Decoupling cap - 1x0.047 $\mu$ F/16V ceramic capacitor (e.g. Murata LLL185R71C473MA01)
- CO2 2 x 47 $\mu$ F/6.3V ceramic capacitor (e.g. Murata GRM31CR60J476ME19 or equivalent)
- CO3 None
- CTune 2200pF ceramic capacitor (can be 1206, 0805 or 0603 size)
- RTune 261 ohms SMT resistor (can be 1206, 0805 or 0603 size)
- RTrim 10k $\Omega$  SMT resistor (can be 1206, 0805 or 0603 size, recommended tolerance of 0.1%)

# NON-ISOLATED DC/DC CONVERTERS

3 Vdc – 14.4 Vdc Input, 0.6 Vdc - 5.5 Vdc /3 A Outputs



Jul. 13, 2015

*Bel Power Inc., a subsidiary of Bel Fuse Inc.*

## Mechanical Outline

Dimensions are in millimeters and (inches).

Tolerances: x.x mm ± 0.5 mm (x.xx in. ± 0.02 in.) [unless otherwise indicated]

x.xx mm ± 0.25 mm (x.xxx in. ± 0.010 in.)

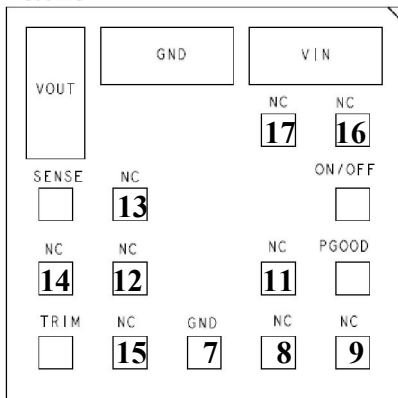
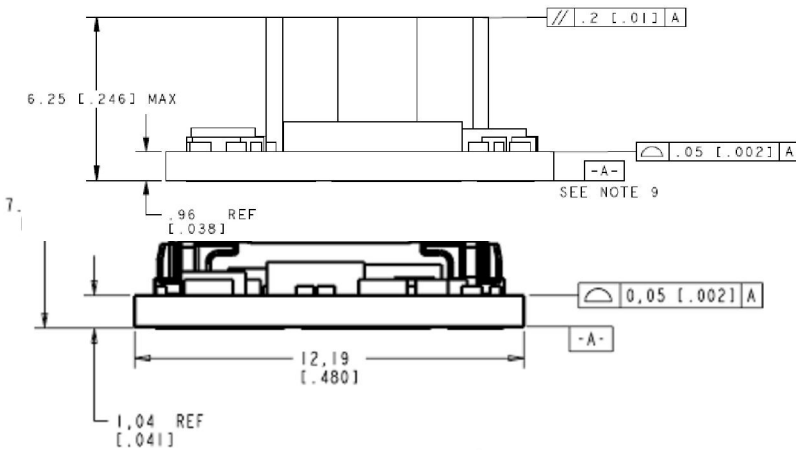
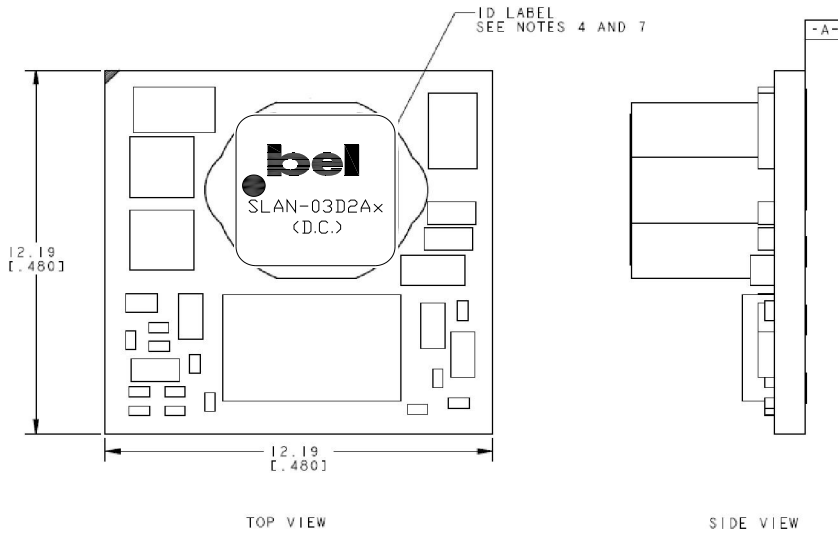

PIN	FUNCTION	PIN	FUNCTION
1	ON/OFF	10	PGOOD
2	VIN	11	NC
3	GND	12	NC
4	VOUT	13	NC
5	VS+ (SENSE)	14	NC
6	TRIM	15	NC
7	GND	16	NC
8	NC	17	NC
9	NC		

# NON-ISOLATED DC/DC CONVERTERS

3 Vdc – 14.4 Vdc Input, 0.6 Vdc - 5.5 Vdc /3 A Outputs



Jul. 13, 2015

Bel Power Inc., a subsidiary of Bel Fuse Inc.

## Recommended Pad Layout

Dimensions are in millimeters and (inches).

Tolerances: x.x mm ± 0.5 mm (x.xx in. ± 0.02 in.) [unless otherwise indicated]

x.xx mm ± 0.25 mm (x.xxx in ± 0.010 in.)

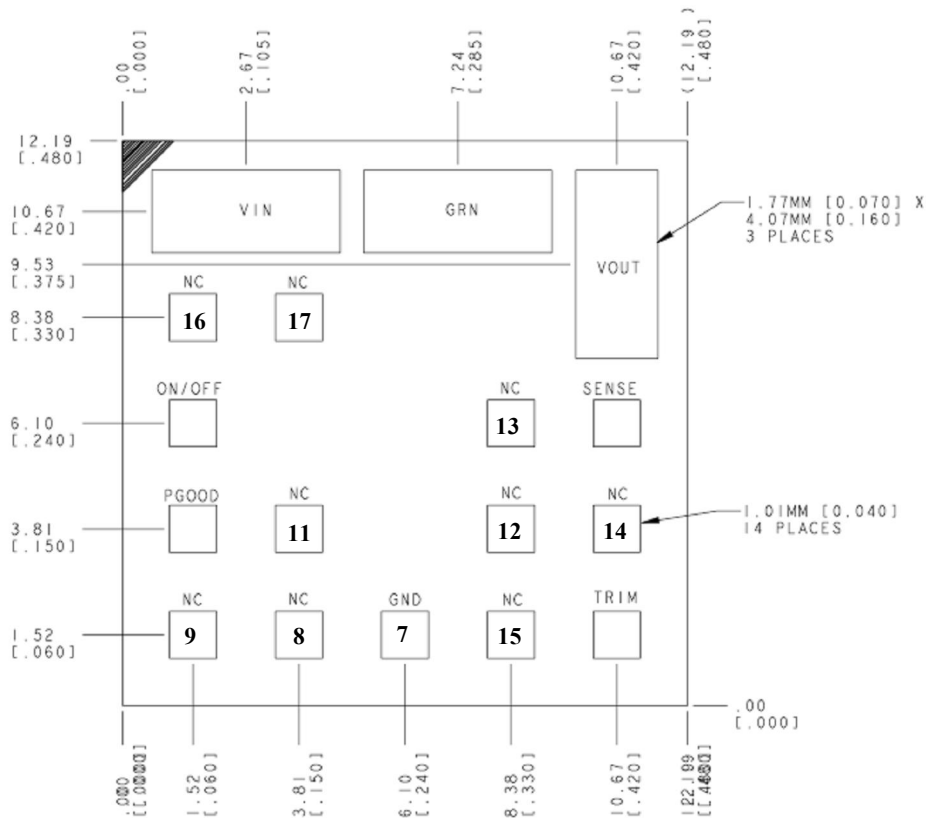

RECOMMENDED FOOTPRINT  
-THROUGH THE BOARD-

PIN	FUNCTION	PIN	FUNCTION
1	ON/OFF	10	PGOOD
2	VIN	11	NC
3	GND	12	NC
4	VOUT	13	NC
5	VS+ (SENSE)	14	NC
6	TRIM	15	NC
7	GND	16	NC
8	NC	17	NC
9	NC		

# NON-ISOLATED DC/DC CONVERTERS

3 Vdc – 14.4 Vdc Input, 0.6 Vdc - 5.5 Vdc /3 A Outputs



Jul. 13, 2015

*Bel Power Inc., a subsidiary of Bel Fuse Inc.*

## Packaging Details

The SLAN-03D2Ax modules are supplied in tape & reel as standard.

All Dimensions are in millimeters and (in inches).

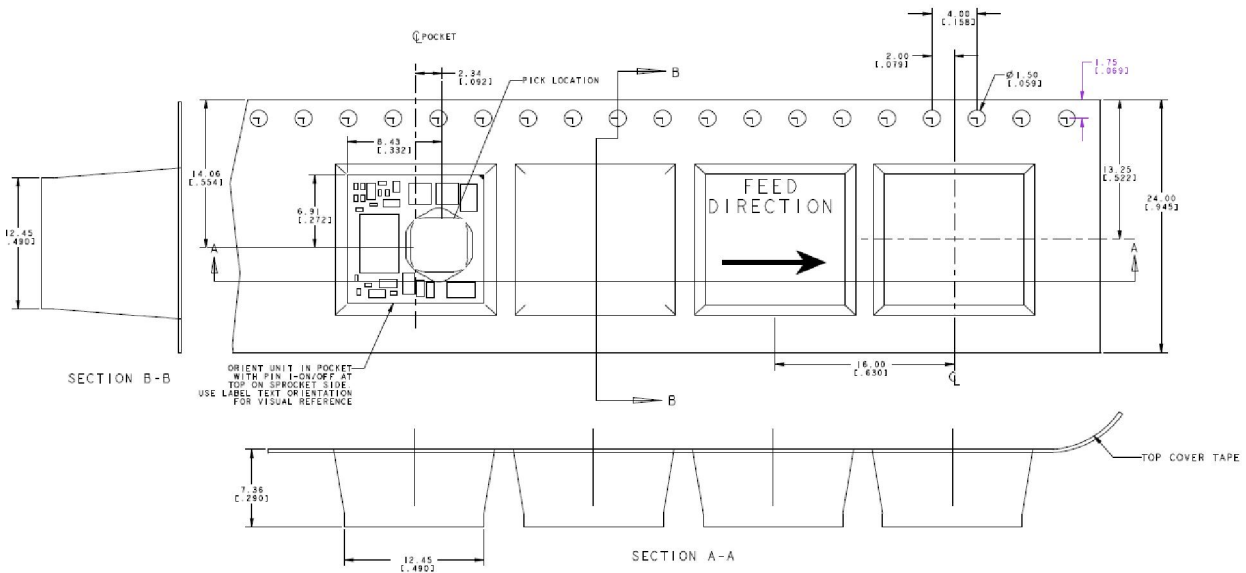
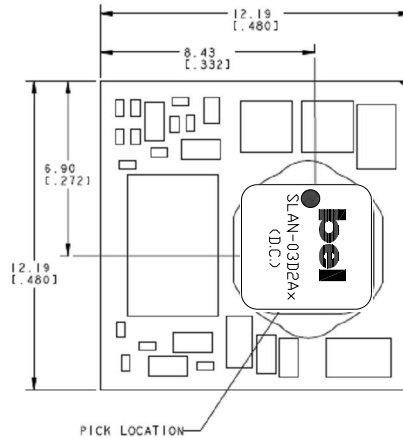

### Reel Dimensions:

Outside Dimensions: 330.2 mm (13.00)

Inside Dimensions: 177.8 mm (7.00")

Tape Width: 24.00 mm (0.945")

## NON-ISOLATED DC/DC CONVERTERS

3 Vdc – 14.4 Vdc Input, 0.6 Vdc - 5.5 Vdc /3 A Outputs



Jul. 13, 2015

*Bel Power Inc., a subsidiary of Bel Fuse Inc.*

### Surface Mount Information

#### Pick and Place

The SLAN-03D2Ax modules use an open frame construction and are designed for a fully automated assembly process. The modules are fitted with a label designed to provide a large surface area for pick and place operations. The label meets all the requirements for surface mount processing, as well as safety standards, and is able to withstand reflow temperatures of up to 300°C. The label also carries product information such as product code, serial number and the location of manufacture.

#### Nozzle Recommendations

The weight has been kept to a minimum by using open frame construction. Variables such as nozzle size, tip style, vacuum pressure and placement speed should be considered to optimize this process. The minimum recommended inside nozzle diameter for reliable operation is 3mm. The maximum nozzle outer diameter, which will safely fit within the allowable component spacing, is 7 mm.

#### Bottom Side / First Side Assembly

This module is not recommended for assembly on the bottom side of a customer board. If such an assembly is attempted, components may fall off the module during the second reflow process.

#### Lead Free Soldering

The SLAN-03D2Ax modules are lead-free (Pb-free) and RoHS compliant and are both forward and backward compatible in a Pb-free and a SnPb soldering process. Failure to observe the instructions below may result in the failure of or cause damage to the modules and can adversely affect long-term reliability.

#### Pb-free Reflow Profile

Power Systems will comply with J-STD-020 Rev. C (Moisture/Reflow Sensitivity Classification for Nonhermetic Solid State Surface Mount Devices) for both Pb-free solder profiles and MSL classification procedures. This standard provides a recommended forced-air-convection reflow profile based on the volume and thickness of the package (table 5-2). The suggested Pb-free solder paste is Sn/Ag/Cu (SAC). For questions regarding LGA, solder volume; please contact Bel Power for special manufacturing process instructions.

The recommended linear reflow profile using Sn/Ag/Cu solder is shown in Fig. 48. Soldering outside of the recommended profile requires testing to verify results and performance.

It is recommended that the pad layout include a test pad where the output pin is in the ground plane. The thermocouple should be attached to this test pad since this will be the coolest solder joints. The temperature of this point should be: Maximum peak temperature is 260 C.

Minimum temperature is 235 C.

Dwell time above 217 C: 60 seconds minimum.

Dwell time above 235 C: 5 to 15 second.

#### MSL Rating

The SLAN-03D2Ax modules have a MSL rating of 2A.

## NON-ISOLATED DC/DC CONVERTERS

3 Vdc – 14.4 Vdc Input, 0.6 Vdc - 5.5 Vdc /3 A Outputs



Jul. 13, 2015

*Bel Power Inc., a subsidiary of Bel Fuse Inc.*

### Storage and Handling

The recommended storage environment and handling procedures for moisture-sensitive surface mount packages is detailed in J-STD-033 Rev. B (Handling, Packing, Shipping and Use of Moisture/Reflow Sensitive Surface Mount Devices). Moisture barrier bags (MBB) with desiccant are required for MSL ratings of 2 or greater. These sealed packages should not be broken until time of use. Once the original package is broken, the floor life of the product at conditions of  $\leq 30^{\circ}\text{C}$  and 60% relative humidity varies according to the MSL rating (see J-STD-033A). The shelf life for dry packed SMT packages will be a minimum of 12 months from the bag seal date, when stored at the following conditions:  $< 40^{\circ}\text{C}$ ,  $< 90\%$  relative humidity.

Figure48

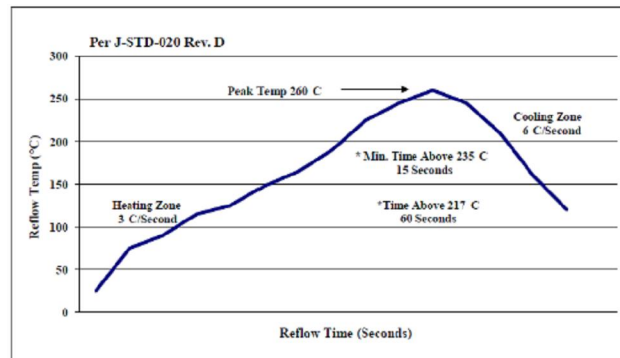

Recommended linear reflow profile using Sn/Ag/Cu solder.

### Post Solder Cleaning and Drying Considerations

Post solder cleaning is usually the final circuit-board assembly process prior to electrical board testing. The result of inadequate cleaning and drying can affect both the reliability of a power module and the testability of the finished circuit-board assembly. For guidance on appropriate soldering, cleaning and drying procedures, refer to Board Mounted Power Modules: Soldering and Cleaning Application Note (AN04-001).

# NON-ISOLATED DC/DC CONVERTERS

3 Vdc – 14.4 Vdc Input, 0.6Vdc - 5.5 Vdc /3 A Outputs



Jul. 13, 2015

*Bel Power Inc., a subsidiary of Bel Fuse Inc.*

## Revision History

Date	Revision	Changes Detail	Approval
2012-03-20	A	First release	HL LU
2015-7-13	B	Update part selection, absolute maximum ratings, Input specifications, output specifications, general specifications, transient response waveforms, safety considerations, remote on/off, voltage margining, over temperature protection, example application circuit, MSL rating and packaging details.	XF Jiang

### RoHS Compliance

Complies with the European Directive 2011/65/EU, calling for the elimination of lead and other hazardous substances from electronic products.



©2015 Bel Fuse Inc. Specifications subject to change without notice. 071315

25

#### CORPORATE

**Bel Fuse Inc.**  
206 Van Vorst Street  
Jersey City, NJ 07302  
Tel 201-432-0463  
Fax 201-432-9542  
[www.belfuse.com](http://www.belfuse.com)

#### FAR EAST

**Bel Fuse Ltd.**  
8F/ 8 Luk Hop Street  
San Po Kong  
Kowloon, Hong Kong  
Tel 852-2328-5515  
Fax 852-2352-3706  
[www.belfuse.com](http://www.belfuse.com)

#### EUROPE

**Bel Fuse Europe Ltd.**  
Preston Technology Management Centre  
Marsh Lane, Suite G7, Preston  
Lancashire, PR1 8UD, U.K.  
Tel 44-1772-556601  
Fax 44-1772-888366  
[www.belfuse.com](http://www.belfuse.com)