



Features

- Ultra-low lead (Pb) content*
- Green technology
- High reliability and stability
- Thick film paste on high grade ceramic substrate
- RoHS compliant** without exemptions
- Halogen free***

Applications

- General purpose
- Consumer
- Industrial
- Telecommunications
- Computer technology

CR-PF Series Ultra-Low Lead Content Thick Film Resistor

Electrical Characteristics

Characteristic	Model				
	CR0402-PF	CR0603-PF	CR0805-PF	CR1206-PF	
Power Rating @ 70 °C	0.0625 W	0.10 W	0.125 W	0.25 W	
Operating Temperature Range	-55 °C to +155 °C				
Derated to Zero Load at	+155 °C				
Maximum Working Voltage	50 V	75 V	150 V	200 V	
Maximum Overload Voltage	100 V	150 V	300 V	400 V	
Resistance Range (±1 %, E24 + E96 Series)	1 Ω ≤ R ≤ 9.76 Ω -200 to +500 PPM/°C		1 Ω ≤ R ≤ 9.76 Ω ±400 PPM/°C		
	10 Ω ≤ R ≤ 100 Ω ±200 PPM/°C		10 Ω ≤ R ≤ 1 MΩ ±100 PPM/°C		
	100 Ω ≤ R ≤ 1 MΩ ±100 PPM/°C		--	--	--
	1 MΩ ≤ R ≤ 10 MΩ ±200 PPM/°C				
Resistance Range (±5 %, E24 Series)	1 Ω ≤ R ≤ 9.1 Ω -200 to +500 PPM/°C		1 Ω ≤ R ≤ 9.1 Ω ±400 PPM/°C		
	10 Ω ≤ R ≤ 10 MΩ ±200 PPM/°C				
Zero Ohm Jumper ≤ 0.05 Ω Rated/Maximum Current	1 A / 2.5 A		2 A / 5 A		

For Standard Values Used in Capacitors, Inductors and Resistors, [click here](#).

Product Dimensions

Model	L	W	C	d	t
CR0402-PF	$\frac{1.00 \pm 0.10}{(0.039 \pm 0.004)}$	$\frac{0.50 \pm 0.05}{(0.020 \pm 0.002)}$	$\frac{0.20 \pm 0.10}{(0.008 \pm 0.004)}$	$\frac{0.25 \pm 0.10}{(0.010 \pm 0.004)}$	$\frac{0.32 \pm 0.05}{(0.013 \pm 0.002)}$
CR0603-PF	$\frac{1.60 \pm 0.10}{(0.063 \pm 0.004)}$	$\frac{0.80 \pm 0.05}{(0.031 \pm 0.002)}$	$\frac{0.30 \pm 0.20}{(0.012 \pm 0.008)}$	$\frac{0.30 \pm 0.20}{(0.012 \pm 0.008)}$	$\frac{0.45 \pm 0.10}{(0.018 \pm 0.004)}$
CR0805-PF	$\frac{2.00 \pm 0.10}{(0.079 \pm 0.004)}$	$\frac{1.25 \pm 0.10}{(0.049 \pm 0.004)}$	$\frac{0.40 \pm 0.20}{(0.016 \pm 0.008)}$	$\frac{0.40 \pm 0.20}{(0.016 \pm 0.008)}$	$\frac{0.50 \pm 0.10}{(0.020 \pm 0.004)}$
CR1206-PF	$\frac{3.10 \pm 0.10}{(0.122 \pm 0.004)}$	$\frac{1.55 \pm 0.10}{(0.061 \pm 0.004)}$	$\frac{0.50 \pm 0.30}{(0.020 \pm 0.012)}$	$\frac{0.40 \pm 0.20}{(0.016 \pm 0.008)}$	$\frac{0.55 \pm 0.10}{(0.022 \pm 0.004)}$

DIMENSIONS: $\frac{\text{MM}}{\text{(INCHES)}}$

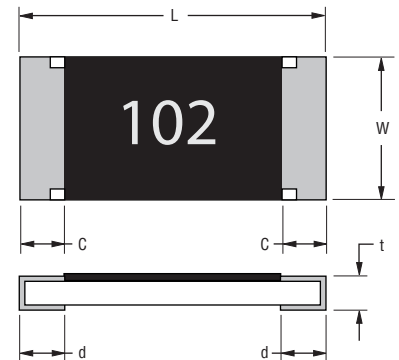

Recommended Solder Pad Layout

Model	a	b	c
CR0402-PF	$\frac{0.5 \sim 0.6}{(0.020 \sim 0.024)}$	$\frac{1.4 \sim 1.6}{(0.055 \sim 0.063)}$	$\frac{0.4 \sim 0.6}{(0.016 \sim 0.024)}$
CR0603-PF	$\frac{0.7 \sim 0.9}{(0.028 \sim 0.035)}$	$\frac{2.0 \sim 2.2}{(0.079 \sim 0.087)}$	$\frac{0.8 \sim 1.0}{(0.031 \sim 0.039)}$
CR0805-PF	$\frac{1.0 \sim 1.4}{(0.039 \sim 0.055)}$	$\frac{3.2 \sim 3.8}{(0.126 \sim 0.150)}$	$\frac{0.9 \sim 1.4}{(0.035 \sim 0.055)}$
CR1206-PF	$\frac{2.0 \sim 2.4}{(0.079 \sim 0.094)}$	$\frac{4.4 \sim 5.0}{(0.173 \sim 0.197)}$	$\frac{1.2 \sim 1.8}{(0.047 \sim 0.071)}$

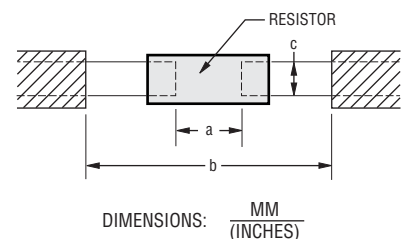

DIMENSIONS: $\frac{\text{MM}}{\text{(INCHES)}}$

* Such products may contain trace amounts of lead of less than 100 ppm.

** RoHS Directive 2015/863, Mar 31, 2015 and Annex.

*** Bourns considers a product to be "halogen free" if (a) the Bromine (Br) content is 900 ppm or less; (b) the Chlorine (Cl) content is 900 ppm or less; and (c) the total Bromine (Br) and Chlorine (Cl) content is 1500 ppm or less.

Specifications are subject to change without notice. Users should verify actual device performance in their specific applications. The products described herein and this document are subject to specific legal disclaimers as set forth on the last page of this document, and at www.bourns.com/docs/legal/disclaimer.pdf



WARNING
Cancer and Reproductive Harm
www.P65Warnings.ca.gov

CR-PF Series Ultra-Low Lead Content Thick Film Resistor

BOURNS®

Construction

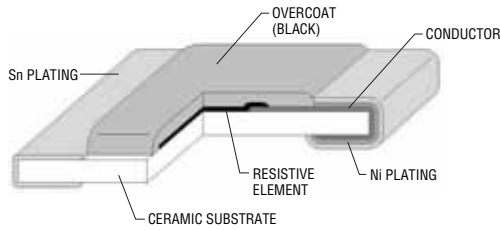

Rated Voltage

The rated voltage is calculated by the following formula:

$$V = \sqrt{P \times R}$$

V: Rated Voltage (V)

P: Rated Power (W)

R: Resistance Value (Ω)

Environmental Characteristics

Moisture Sensitivity Level..... 1
 ESD Classification (HBM)..... 1A
 Storage Conditions
 Temperature +5 °C ~ +35 °C
 Humidity 40 % ~ 75 %
 Shelf Life..... 2 years from manufacturing date
 Solder Recommendations..... Reflow profile
 (Solder: Sn96.5 / Ag3 / Cu05)

Derating Curve

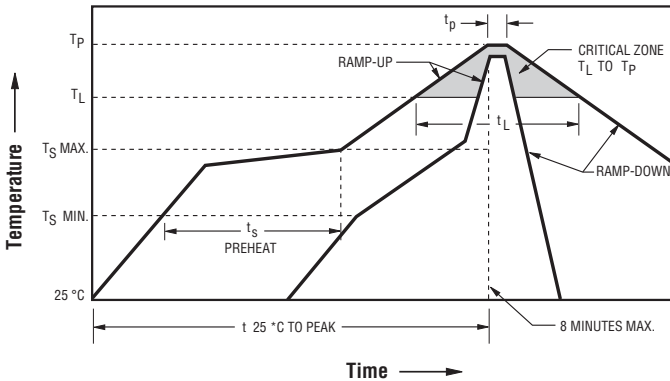
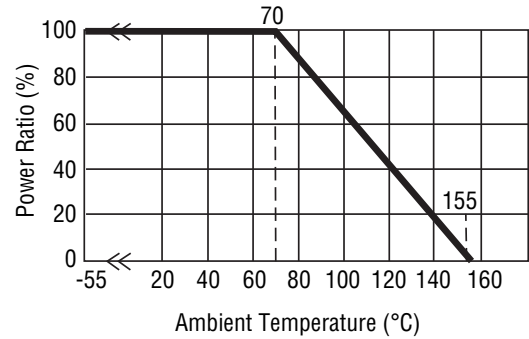

Solder Profile	Lead Free Assembly
Average ramp-up rate (T _{smax} to T _p)	3 °C / second max.
Preheat: - Temperature Min. (T _{smin}) - Temperature Max. (T _{smax}) - Time (T _{smin} to T _{smax}) (t _s)	150 °C 200 °C 60~150 seconds
Time maintained above: - Temperature (T _L) - Time (T _L)	217 °C 60~120 seconds
Peak Temperature (T _p)	260 °C
Time within +0/-5 °C of actual Peak Temperature (T _p) ²	10 seconds
Ramp-down rate	6 °C / second max.
Time 25 °C to Peak Temperature	8 minutes max.

Specifications are subject to change without notice.

Users should verify actual device performance in their specific applications.

The products described herein and this document are subject to specific legal disclaimers as set forth on the last page of this document, and at www.bourns.com/docs/legal/disclaimer.pdf.

CR-PF Series Ultra-Low Lead Content Thick Film Resistor

BOURNS®

How to Order

CR 0402 - F X - 1003 G PF

Model _____
CR = Thick Film Fixed Resistor Chip

Size _____
0402 = 0402 Size
0603 = 0603 Size
0805 = 0805 Size
1206 = 1206 Size

Resistance Tolerance _____
F = $\pm 1\%$
J = $\pm 5\%$

TCR (See Electrical Characteristics chart) _____
W = ± 200 PPM/ $^{\circ}$ C
X = ± 100 PPM/ $^{\circ}$ C
/ = Used for zero ohm (jumper) and values from 1 ohm through 9.1 ohms

Resistance Value _____
1 % Tolerance:
<100 ohms.....“R” represents decimal point (*example: 24R3 = 24.3 ohms*)
 ≥ 100 ohms.....First three digits are significant, fourth digit represents number of zeros to follow
(*example: 8252 = 82.5K ohms*)

5 % Tolerance:
<10 ohms.....“R” represents decimal point (*example: 4R7 = 4.7 ohms*)
 ≥ 10 ohms.....First two digits are significant, third digit represents number of zeros to follow
(*example: 474 = 470K ohms; 000 = Jumper*)

Packaging _____
G = 10,000 pieces on 180 mm (7 inch) plastic reel, paper tape - CR0402-PF
E = 5,000 pieces on 180 mm (7 inch) plastic reel, paper tape - CR0603-PF, CR0805-PF, CR1206-PF

Feature _____
PF = Ultra-low Lead Content

Specifications are subject to change without notice.

Users should verify actual device performance in their specific applications.

The products described herein and this document are subject to specific legal disclaimers as set forth on the last page of this document, and at www.bourns.com/docs/legal/disclaimer.pdf.

Performance Characteristics

Test	Specification	Procedure	Test Limits ΔR
Temperature Coefficient of Resistance	IEC 60115-1-4.8 JIS-C5201-4.8	+25 °C ~ +125 °C	--
Short Time Overload	IEC 60115-1-4.13 JIS-C5201-1-4.13	2.5 times rated power for 5 seconds	$\pm(1\% + 0.05\ \Omega)$ <i>Remarks:</i> 0402: $\pm(2\% + 0.1\ \Omega)$ 0 Ω : 50 m Ω or less
Intermittent Overload	IEC 60115-1-4.39 JIS-C5201-1-4.39	3 times rated voltage or max. overloading voltage, 1 second "ON", 25 seconds "OFF", 10,000 cycles <i>Remarks:</i> 0402: 2.5 times rated voltage or max. overloading voltage	$\pm(5\% + 0.1\ \Omega)$ <i>Remarks:</i> 0 Ω : 50 m Ω or less
Endurance (Load Life)	IEC 60115-1-4.25.1 JIS-C5201-1-4.25.1	1000 hours at rated voltage, +70 °C, 1.5 hours "ON", 0.5 hour "OFF"	1 %: $\pm(1\% + 0.05\ \Omega)$ 5 %: $\pm(3\% + 0.1\ \Omega)$ <i>Remarks:</i> 0402: $\pm(3\% + 0.1\ \Omega)$ 0 Ω : 100 m Ω or less
Load Life with Humidity	IEC 60115-1-4.24 JIS-C5201-1-4.24	1000 hours at rated voltage, +40 ± 2 °C, 90~95 % RH, 1.5 hours "ON", 0.5 hour "OFF"	1 %: $\pm(1\% + 0.05\ \Omega)$ 5 %: $\pm(3\% + 0.1\ \Omega)$ <i>Remarks:</i> 0402: $\pm(3\% + 0.1\ \Omega)$ 0 Ω : 100 m Ω or less
Rapid Change of Temperature	IEC 60115-1-4.19 JIS-C5201-1-4.19	-55 °C (30 minutes) / +155 °C (30 minutes) 5 cycles	1 %: $\pm(0.5\% + 0.05\ \Omega)$ 5 %: $\pm(1\% + 0.05\ \Omega)$ <i>Remarks:</i> 0 Ω : 50 m Ω or less
Solderability	IEC 60115-1-4.17 JIS-C5201-1-4.17	245 ± 5 °C solder for 2 ± 0.5 seconds; Solder: Sn96.5 / Ag3.0 / Cu0.5	At least 95 % of surface area of electrode shall be covered with new solder.
Moisture No Load	IEC 60115-1-4.24.2.1a JIS-C5201-1-4.24.2.1a	+85 °C, 85 % RH, 1000 hours	< $\pm 0.5\%$
Temperature Cycle	IEC 60115-1-4.19 JIS-C5201-1-4.19	-55 °C and +155 °C, 100 cycles, 15 minutes per extreme condition	< $\pm 0.5\%$
Resistance to Soldering Heat	IEC 60115-1-4.18 JIS-C5201-1-4.18	260 ± 5 °C for 10 ± 1 seconds	< $\pm 0.5\%$
Robustness of Termination (Bending)	IEC 60115-1-4.33 JIS-C5201-1-4.33	3 mm deflection	1 %: $\pm(0.5\% + 0.05\ \Omega)$ 5 %: $\pm(1\% + 0.05\ \Omega)$ <i>Remarks:</i> 0 Ω : 50 m Ω or less
Dielectric Withstanding Voltage (Voltage Proof)	IEC 60115-1-4.7 JIS-C5201-1-4.7	Applied voltage for 1 minute: 0402 & 0603: 300 V 0805 & 1206: 500 V	No abnormalities such as flashover, burning, or dielectric breakdown shall occur.
Insulation Resistance	IEC 60115-1-4.6 JIS-C5201-1-4.6	Applied voltage for 1 minute: 100 V	$\geq 1\ \text{G}\Omega$
Resistance to Dry Heat	IEC 60115-1-4.23.2 JIS-C5201-1-4.23.2	155 ± 5 °C for 96 ± 4 hours	1 %: $\pm(1\% + 0.05\ \Omega)$ 5 %: $\pm(2\% + 0.1\ \Omega)$ <i>Remarks:</i> 0 Ω : 50 m Ω or less
Resistance to Solder Heat	IEC 60115-1-4.18 JIS-C5201-1-4.18	270 ± 5 °C solder for 10 ± 1 seconds	1 %: $\pm(0.5\% + 0.05\ \Omega)$ 5 %: $\pm(1\% + 0.05\ \Omega)$ <i>Remarks:</i> 0 Ω : 50 m Ω or less

Specifications are subject to change without notice.

Users should verify actual device performance in their specific applications.

The products described herein and this document are subject to specific legal disclaimers as set forth on the last page of this document, and at www.bourns.com/docs/legal/disclaimer.pdf.

CR-PF Series Ultra-Low Lead Content Thick Film Resistor



Typical Part Marking

±5 % (E24):

CR0603-PF, CR0805-PF, CR1206-PF

Resistance value is expressed by 3 digits. The first two digits represent the significant figures of the nominal resistance value in ohms; the third digit represents the exponent for a base of 10.

Example: 102 = 10 x 10² = 1000 ohms = 1K ohms

Note: "R" represents the decimal point for CR1206-PF.

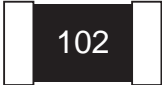

±1 % (E96):

CR0603-PF

In cases where the marking space is too small to accommodate 4 digits, the marking shall consist of 2 digits followed by an alpha character multiplier.

Example: 01A = 100 x 100 = 100 ohms



Code	R Value	Code	R Value	Code	R Value	Code	R Value	Code	R Value	Code	R Value	Code	R Value	Code	R Value
01	100	13	133	25	178	37	237	49	316	61	422	73	562	85	750
02	102	14	137	26	182	38	243	50	324	62	432	74	576	86	768
03	105	15	140	27	187	39	249	51	332	63	442	75	590	87	787
04	107	16	143	28	191	40	255	52	340	64	453	76	604	88	806
05	110	17	147	29	196	41	261	53	348	65	464	77	619	89	825
06	113	18	150	30	200	42	267	54	357	66	475	78	634	90	845
07	115	19	154	31	205	43	274	55	365	67	487	79	649	91	866
08	118	20	158	32	210	44	280	56	374	68	499	80	665	92	887
09	121	21	162	33	215	45	287	57	383	69	511	81	681	93	909
10	124	22	165	34	221	46	294	58	392	70	523	82	698	94	931
11	127	23	169	35	226	47	301	59	402	71	536	83	715	95	953
12	130	24	174	36	232	48	309	60	412	72	549	84	732	96	976

This table shows the first two digits for the three-digit E96 part marking scheme. The third character is a letter multiplier: A=10⁰ B=10¹ C=10² D=10³ E=10⁴ F=10⁵ G=10⁶ H=10⁷ X=10⁻¹ Y=10⁻² Z=10⁻³

Note: When the resistance value is not in the E96 table, the marking shall consist of 3 digits as in E24 series, with underline.

Example: 121 = 0603, 120 ohms, 1 %



Jumper:

CR0603-PF, CR0805-PF, CR1206-PF

Example: 0 = 0 ohms



No Marking:

CR0402-PF



CR-PF Series Ultra-Low Lead Content Thick Film Resistor



Packaging Dimensions (Conforms to EIA RS-481A)

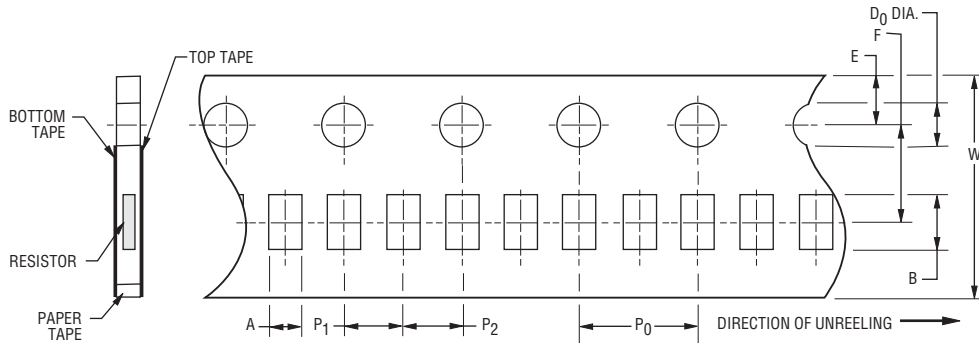

Model	A	B	W	F	E	P ₁	P ₂	P ₀	D ₀	T
CR0402-PF	0.70 ± 0.05 (.028 ± .002)	1.20 ± 0.05 (.047 ± .002)				2.00 ± 0.10 (.079 ± .004)	2.00 ± 0.10 (.079 ± .004)			0.45 ± 0.10 (.018 ± .004)
	1.10 ± 0.10 (.043 ± .004)	1.90 ± 0.10 (.075 ± .004)				4.00 ± 0.10 (.158 ± .004)	2.00 ± 0.05 (.079 ± .002)			0.64 ± 0.10 (.025 ± .004)
CR0603-PF	1.10 ± 0.10 (.043 ± .004)	1.90 ± 0.10 (.075 ± .004)	8.00 ± 0.20 (.315 ± .008)	3.50 ± 0.05 (.138 ± .002)	1.75 ± 0.10 (.069 ± .004)	4.00 ± 0.10 (.158 ± .004)	2.00 ± 0.05 (.079 ± .002)	4.00 ± 0.10 (.158 ± .004)	1.50 ± 0.10 (.066 ± .004)	0.84 ± 0.10 (.033 ± .004)
CR0805-PF	1.60 ± 0.15 (.063 ± .006)	2.40 ± 0.20 (.094 ± .008)								0.84 ± 0.10 (.033 ± .004)
CR1206-PF	2.00 ± 0.15 (.079 ± .006)	3.60 ± 0.20 (.142 ± .008)								0.84 ± 0.10 (.033 ± .004)

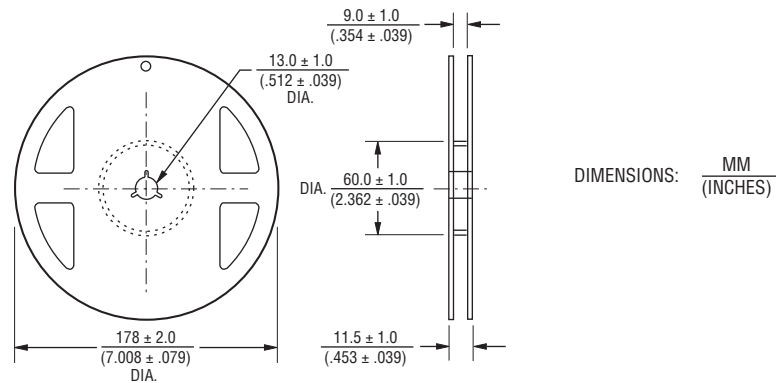

Asia-Pacific: Tel: +886-2 2562-4117 • Email: asiacus@bourns.com

EMEA: Tel: +36 88 885 877 • Email: eurocus@bourns.com

The Americas: Tel: +1-951 781-5500 • Email: americus@bourns.com

www.bourns.com

09/19

Specifications are subject to change without notice.

Users should verify actual device performance in their specific applications.

The products described herein and this document are subject to specific legal disclaimers as set forth on the last page of this document, and at www.bourns.com/docs/legal/disclaimer.pdf.

This legal disclaimer applies to purchasers and users of Bourns® products manufactured by or on behalf of Bourns, Inc. and its affiliates (collectively, “Bourns”).

Unless otherwise expressly indicated in writing, Bourns® products and data sheets relating thereto are subject to change without notice. Users should check for and obtain the latest relevant information and verify that such information is current and complete before placing orders for Bourns® products.

The characteristics and parameters of a Bourns® product set forth in its data sheet are based on laboratory conditions, and statements regarding the suitability of products for certain types of applications are based on Bourns’ knowledge of typical requirements in generic applications. The characteristics and parameters of a Bourns® product in a user application may vary from the data sheet characteristics and parameters due to (i) the combination of the Bourns® product with other components in the user’s application, or (ii) the environment of the user application itself. The characteristics and parameters of a Bourns® product also can and do vary in different applications and actual performance may vary over time. Users should always verify the actual performance of the Bourns® product in their specific devices and applications, and make their own independent judgments regarding the amount of additional test margin to design into their device or application to compensate for differences between laboratory and real world conditions.

Unless Bourns has explicitly designated an individual Bourns® product as meeting the requirements of a particular industry standard (e.g., ISO/TS 16949) or a particular qualification (e.g., UL listed or recognized), Bourns is not responsible for any failure of an individual Bourns® product to meet the requirements of such industry standard or particular qualification. Users of Bourns® products are responsible for ensuring compliance with safety-related requirements and standards applicable to their devices or applications.

Bourns® products are not recommended, authorized or intended for use in nuclear, lifesaving, life-critical or life-sustaining applications, nor in any other applications where failure or malfunction may result in personal injury, death, or severe property or environmental damage. Unless expressly and specifically approved in writing by two authorized Bourns representatives on a case-by-case basis, use of any Bourns® products in such unauthorized applications might not be safe and thus is at the user’s sole risk. Life-critical applications include devices identified by the U.S. Food and Drug Administration as Class III devices and generally equivalent classifications outside of the United States.

Bourns expressly identifies those Bourns® standard products that are suitable for use in automotive applications on such products’ data sheets in the section entitled “Applications.” Unless expressly and specifically approved in writing by two authorized Bourns representatives on a case-by-case basis, use of any other Bourns® standard products in an automotive application might not be safe and thus is not recommended, authorized or intended and is at the user’s sole risk. If Bourns expressly identifies a sub-category of automotive application in the data sheet for its standard products (such as infotainment or lighting), such identification means that Bourns has reviewed its standard product and has determined that if such Bourns® standard product is considered for potential use in automotive applications, it should only be used in such sub-category of automotive applications. Any reference to Bourns® standard product in the data sheet as compliant with the AEC-Q standard or “automotive grade” does not by itself mean that Bourns has approved such product for use in an automotive application.

Bourns® standard products are not tested to comply with United States Federal Aviation Administration standards generally or any other generally equivalent governmental organization standard applicable to products designed or manufactured for use in aircraft or space applications. Bourns expressly identifies Bourns® standard products that are suitable for use in aircraft or space applications on such products’ data sheets in the section entitled “Applications.” Unless expressly and specifically approved in writing by two authorized Bourns representatives on a case-by-case basis, use of any other Bourns® standard product in an aircraft or space application might not be safe and thus is not recommended, authorized or intended and is at the user’s sole risk.

The use and level of testing applicable to Bourns® custom products shall be negotiated on a case-by-case basis by Bourns and the user for which such Bourns® custom products are specially designed. Absent a written agreement between Bourns and the user regarding the use and level of such testing, the above provisions applicable to Bourns® standard products shall also apply to such Bourns® custom products.

Users shall not sell, transfer, export or re-export any Bourns® products or technology for use in activities which involve the design, development, production, use or stockpiling of nuclear, chemical or biological weapons or missiles, nor shall they use Bourns® products or technology in any facility which engages in activities relating to such devices. The foregoing restrictions apply to all uses and applications that violate national or international prohibitions, including embargos or international regulations. Further, Bourns® products and Bourns technology and technical data may not under any circumstance be exported or re-exported to countries subject to international sanctions or embargoes. Bourns® products may not, without prior authorization from Bourns and/or the U.S. Government, be resold, transferred, or re-exported to any party not eligible to receive U.S. commodities, software, and technical data.

To the maximum extent permitted by applicable law, Bourns disclaims (i) any and all liability for special, punitive, consequential, incidental or indirect damages or lost revenues or lost profits, and (ii) any and all implied warranties, including implied warranties of fitness for particular purpose, non-infringement and merchantability.

For your convenience, copies of this Legal Disclaimer Notice with German, Spanish, Japanese, Traditional Chinese and Simplified Chinese bilingual versions are available at:

Web Page: <http://www.bourns.com/legal/disclaimers-terms-and-policies>

PDF: <http://www.bourns.com/docs/Legal/disclaimer.pdf>