

# Power Chokes – Vertical Mount



The Coilcraft PCV power chokes are low cost power inductors whose simple design provides rugged reliability and performance. They feature 130°C class insulation and are available in a wide range of standard values.

The open core construction provides the highest saturation current available in a low cost power choke. These parts use a ferrite bobbin core to provide the highest possible inductance at the lowest cost. The PCV-1 Series incorporates a plastic mounting header for maximum lead protection and consistency.

Coilcraft **Designer's Kit P405** contains samples of the part numbers shown in bold from the PCV-0 and PCV-2 series. Contact Coilcraft or visit <http://order.coilcraft.com> to purchase on-line.

## PCV-0 Series

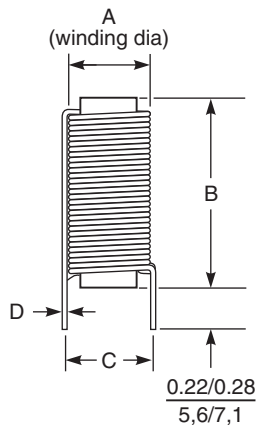

## PCV-1 Series

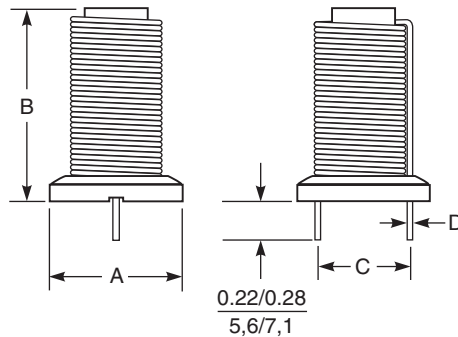

## PCV-2 Series

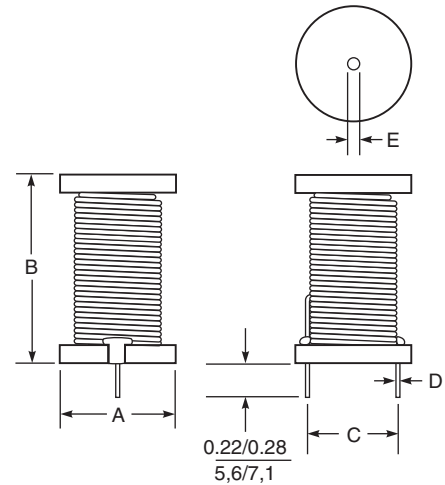

Dimensions are in  $\frac{\text{inches}}{\text{mm}}$

**Terminations:** Tin-silver (96.5/3.5) over copper  
See last page for packaging information.



**US** +1-847-639-6400 sales@coilcraft.com  
**UK** +44-1236-730595 sales@coilcraft-europe.com  
**Taiwan** +886-2-2264 3646 sales@coilcraft.com.tw  
**China** +86-21-6218 8074 sales@coilcraft.com.cn  
**Singapore** + 65-6484 8412 sales@coilcraft.com.sg

Document 135-1 Revised 07/10/14

© Coilcraft Inc. 2014  
This product may not be used in medical or high risk applications without prior Coilcraft approval. Specification subject to change without notice. Please check web site for latest information.



# Power Chokes – Vertical Mount

Part number	Inductance <sup>1</sup> (µH)	Irms <sup>2</sup> (A)	DCR max (Ohms)	A max (in/mm)	B max (in/mm)	C ±0.015/0,38 (in/mm)	D ±0.004/0,10 (in/mm)	Weight (g)
<b>PCV-0 Series</b>								
PCV-0-102-25L	1.0 ±15%	21.8	0.002	0.60/15,2	0.68/17,3	0.42/10,7	0.068/1,73	5.6
PCV-0-102-10L	1.0 ±15%	16.7	0.003	0.50/12,7	0.75/19,1	0.42/10,7	0.054/1,37	4.2
PCV-0-332-10L	3.3 ±15%	12.7	0.005	0.50/12,7	1.0/25,4	0.42/10,7	0.054/1,37	6.7
<b>PCV-0-472-03L</b>	4.7 ±15%	7.4	0.021	0.51/13,0	0.75/19,1	0.42/10,7	0.035/0,89	3.7
<b>PCV-0-472-05L</b>	4.7 ±15%	8.9	0.012	0.50/12,7	0.75/19,1	0.42/10,7	0.042/1,07	5.0
<b>PCV-0-472-10L</b>	4.7 ±15%	11.9	0.012	0.50/12,7	1.0/25,4	0.42/10,7	0.054/1,37	7.5
PCV-0-472-20L	4.7 ±15%	16.4	0.004	0.53/13,5	1.2/30,5	0.42/10,7	0.068/1,73	11.9
<b>PCV-0-103-03L</b>	10 ±10%	5.9	0.023	0.50/12,7	0.75/19,1	0.42/10,7	0.035/0,89	4.4
<b>PCV-0-103-05L</b>	10 ±10%	7.1	0.017	0.50/12,7	0.75/19,1	0.42/10,7	0.042/1,07	6.4
<b>PCV-0-103-10L</b>	10 ±10%	11.8	0.015	0.52/13,2	1.0/25,4	0.42/10,7	0.054/1,37	9.5
PCV-0-103-20L	10 ±10%	17.0	0.006	0.75/19,1	1.8/45,7	0.60/15,2	0.075/1,91	28.6
PCV-0-153-03L	15 ±10%	6.8	0.025	0.50/12,7	1.0/25,4	0.42/10,7	0.035/0,89	5.9
PCV-0-153-10L	15 ±10%	9.8	0.020	0.52/13,2	1.0/25,4	0.42/10,7	0.054/1,37	11.3
<b>PCV-0-223-03L</b>	22 ±10%	7.4	0.035	0.50/12,7	1.0/25,4	0.42/10,7	0.035/0,89	6.4
<b>PCV-0-223-05L</b>	22 ±10%	8.9	0.023	0.50/12,7	1.0/25,4	0.42/10,7	0.042/1,07	9.3
<b>PCV-0-223-10L</b>	22 ±10%	13.0	0.015	0.66/16,8	1.3/33,0	0.42/10,7	0.060/1,52	21.0
PCV-0-273-05L	27 ±10%	7.1	0.024	0.50/12,7	1.0/25,4	0.49/12,5	0.042/1,07	10.3
PCV-0-333-12L	33 ±10%	11.0	0.017	0.70/17,8	1.3/33,0	0.55/14,0	0.060/1,52	29.3
<b>PCV-0-473-03L</b>	47 ±10%	4.3	0.050	0.55/14,0	1.0/25,4	0.42/10,7	0.035/0,89	8.5
<b>PCV-0-473-05L</b>	47 ±10%	6.0	0.035	0.65/16,5	1.1/28,0	0.70/17,8	0.042/1,07	13.1
<b>PCV-0-473-10L</b>	47 ±10%	8.7	0.022	0.85/21,6	1.3/33,0	0.70/17,8	0.060/1,52	31.4
PCV-0-823-03L	82 ±10%	2.8	0.110	0.50/12,7	0.65/16,5	0.375/9,5	0.028/0,71	7.0
PCV-0-104-01L	100 ±10%	1.8	0.190	0.40/10,2	0.90/22,9	0.30/7,6	0.020/0,51	5.0
<b>PCV-0-104-03L</b>	100 ±10%	3.8	0.072	0.55/14,0	1.2/30,5	0.70/17,8	0.035/0,89	11.6
<b>PCV-0-104-05L</b>	100 ±10%	5.5	0.055	0.65/16,5	1.3/33,0	0.70/17,8	0.042/1,07	21.3
PCV-0-154-03L	150 ±10%	2.8	0.140	0.60/15,2	1.2/30,5	0.43/10,9	0.028/0,71	11.8
PCV-0-154-05L	150 ±10%	5.2	0.065	0.65/16,5	1.3/33,0	0.70/17,8	0.042/1,07	26.4
PCV-0-184-05L	180 ±10%	3.3	0.110	0.60/15,2	1.2/30,5	0.43/10,9	0.035/0,89	17.9
PCV-0-224-03L	220 ±10%	2.1	0.210	0.55/14,0	1.2/30,5	0.42/10,7	0.025/0,64	8.9
PCV-0-274-04L	270 ±10%	2.1	0.250	0.95/24,0	0.72/18,3	0.71/18,0	0.030/0,76	26.8
PCV-0-274-10L	270 ±10%	3.6	0.160	1.1/28,0	1.0/25,4	0.72/18,3	0.038/0,97	38.8
PCV-0-394-03L	390 ±10%	3.0	0.250	1.1/28,0	1.0/25,4	0.72/18,3	0.035/0,89	37.1
PCV-0-394-05L	390 ±10%	3.1	0.190	1.1/28,0	1.0/25,4	0.72/18,3	0.038/0,97	45.4
<b>PCV-1 Series</b>								
PCV-1-152-15L	1.5 ±15%	18.2	0.003	0.65/16,5	0.90/22,9	0.42/10,7	0.068/1,73	8.0
PCV-1-182-10L	1.8 ±15%	18.2	0.006	0.65/16,5	1.1/27,9	0.42/10,7	0.054/1,37	6.2
PCV-1-182-15L	1.8 ±15%	19.3	0.003	0.65/16,5	1.1/27,9	0.42/10,7	0.068/1,73	8.5
PCV-1-472-03L	4.7 ±15%	7.5	0.021	0.62/15,7	0.85/21,6	0.42/10,7	0.035/0,89	5.2
PCV-1-472-05L	4.7 ±15%	9.1	0.012	0.62/15,7	0.85/21,6	0.42/10,7	0.042/1,07	5.6
PCV-1-472-10L	4.7 ±15%	11.8	0.012	0.62/15,7	1.1/27,9	0.42/10,7	0.054/1,37	8.5
PCV-1-103-03L	10 ±10%	6.0	0.026	0.63/16,0	0.85/21,6	0.42/10,7	0.035/0,89	4.4
PCV-1-103-05L	10 ±10%	7.1	0.020	0.62/15,7	0.85/21,6	0.42/10,7	0.042/1,07	7.5
PCV-1-103-10L	10 ±10%	10.9	0.013	0.63/16,0	1.1/27,9	0.42/10,7	0.054/1,37	5.2
PCV-1-153-10L	15 ±10%	11.8	0.020	0.70/17,8	1.4/35,6	0.42/10,7	0.060/1,52	18.4
PCV-1-223-03L	22 ±10%	5.5	0.035	0.62/15,7	1.1/27,9	0.42/10,7	0.035/0,89	7.4
PCV-1-223-05L	22 ±10%	6.9	0.023	0.62/15,7	1.1/27,9	0.42/10,7	0.042/1,07	10.2
PCV-1-223-10L	22 ±10%	10.4	0.018	0.70/17,8	1.4/35,6	0.42/10,7	0.060/1,52	21.8
PCV-1-473-03L	47 ±10%	5.3	0.050	0.65/16,5	1.1/27,9	0.42/10,7	0.035/0,89	9.6
PCV-1-473-05L	47 ±10%	6.3	0.033	0.90/22,9	1.2/30,5	0.70/17,8	0.042/1,07	14.9
PCV-1-473-10L	47 ±10%	8.2	0.022	0.90/22,9	1.4/35,6	0.70/17,8	0.060/1,52	32.9
PCV-1-104-03L	100 ±10%	3.4	0.072	0.90/22,9	1.3/33,1	0.70/17,8	0.035/0,89	13.3
PCV-1-104-05L	100 ±10%	4.9	0.055	0.90/22,9	1.4/35,6	0.70/17,8	0.042/1,07	22.9
PCV-1-184-03L	180 ±10%	2.8	0.150	0.63/16,0	1.2/30,5	0.42/10,7	0.028/0,71	10.7
PCV-1-304-05L	300 ±10%	3.4	0.160	1.1/27,9	1.0/25,4	0.70/17,8	0.038/0,97	41.1
PCV-1-394-05L	390 ±10%	3.0	0.190	1.1/27,9	1.0/25,4	0.70/17,8	0.038/0,97	47.3



www.coilcraft.com

US +1-847-639-6400 sales@coilcraft.com  
 UK +44-1236-730595 sales@coilcraft-europe.com  
 Taiwan +886-2-2264 3646 sales@coilcraft.com.tw  
 China +86-21-6218 8074 sales@coilcraft.com.cn  
 Singapore + 65-6484 8412 sales@coilcraft.com.sg

Document 135-2 Revised 07/10/14

© Coilcraft Inc. 2014

This product may not be used in medical or high risk applications without prior Coilcraft approval. Specification subject to change without notice. Please check web site for latest information.



# Power Chokes – Vertical Mount

Part number	Inductance <sup>1</sup> ±10% (µH)	I <sub>rms</sub> <sup>2</sup> (A)	DCR max (Ohms)	A max (in/mm)	B max (in/mm)	C ±0.015/0,38 (in/mm)	D ±0.004/0,10 (in/mm)	E min (in/mm)	Weight (g)
<b>PCV-2 Series</b>									
PCV-2-103-05L	10	10.5	0.015	0.61/15,49	0.83/21,08	0.42/10,67	0.042/1,07	0.116/2,95	11.8
PCV-2-103-10L	10	11.8	0.010	0.61/15,49	0.83/21,08	0.50/12,70	0.054/1,37	0.116/2,95	11.8
PCV-2-223-05L	22	7.6	0.020	0.61/15,49	0.83/21,08	0.42/10,67	0.042/1,07	0.116/2,95	13.7
PCV-2-223-10L	22	10.3	0.015	0.86/21,84	0.83/21,08	0.58/14,73	0.054/1,37	0.116/2,95	23.3
PCV-2-473-05L	47	5.0	0.035	0.70/17,78	0.83/21,08	0.48/12,19	0.038/0,97	0.116/2,95	14.8
<b>PCV-2-473-10L</b>	47	9.6	0.020	1.00/25,40	0.83/21,08	0.70/17,78	0.054/1,37	0.116/2,95	36.9
PCV-2-104-03L	100	4.4	0.080	0.84/21,34	0.83/21,08	0.58/14,73	0.031/0,79	0.116/2,95	19.2
PCV-2-104-05L	100	5.6	0.048	0.84/21,34	0.83/21,08	0.70/17,78	0.042/1,07	0.116/2,95	19.0
PCV-2-104-10L	100	10.1	0.032	1.05/26,67	1.00/25,40	0.88/22,35	0.054/1,37	0.116/2,95	46.6
PCV-2-184-05L	180	4.0	0.092	0.80/20,32	0.90/22,86	0.58/14,73	0.035/0,89	0.116/2,95	25.1
PCV-2-184-10L	180	8.0	0.048	1.44/36,58	1.05/26,67	1.05/26,67	0.054/1,37	0.175/4,45	93.8
PCV-2-224-05L	220	6.6	0.075	1.05/26,67	1.00/25,40	0.75/19,05	0.042/1,07	0.116/2,95	40.0
<b>PCV-2-274-03L</b>	270	4.3	0.130	1.00/25,40	0.83/21,08	0.75/19,05	0.035/0,89	0.116/2,95	35.7
<b>PCV-2-274-05L</b>	270	5.2	0.080	1.05/26,67	1.00/25,40	0.80/20,32	0.042/1,07	0.116/2,95	47.8
<b>PCV-2-274-10L</b>	270	7.2	0.060	1.50/38,10	1.05/26,67	1.08/27,43	0.054/1,37	0.175/4,45	103.0
PCV-2-394-05L	390	3.9	0.130	1.10/29,34	0.83/21,08	0.85/21,59	0.038/0,97	0.116/2,95	42.3
PCV-2-564-02L	560	2.6	0.270	0.80/20,32	0.90/22,86	0.57/14,48	0.028/0,71	0.116/2,95	26.8
PCV-2-564-06L	560	4.0	0.170	1.21/30,73	1.05/26,67	0.90/22,86	0.038/0,97	0.116/2,95	66.4
PCV-2-564-08L	560	7.0	0.090	1.50/38,10	1.43/36,32	1.08/27,43	0.054/1,37	0.175/4,45	135.6
PCV-2-684-01L	680	1.3	0.700	0.70/17,78	0.83/21,08	0.50/12,70	0.018/0,46	0.116/2,95	12.5
PCV-2-105-02L	1000	2.3	0.370	1.00/25,40	0.83/21,08	0.72/18,29	0.028/0,71	0.116/2,95	39.2

1. Tested at 15.75 kHz, 0.1 V<sub>rms</sub>, with DC bias applied up to the I<sub>rms</sub> current.
2. Current that causes a 40°C temperature rise from 25°C ambient.
3. **Ambient temperature range:** -40°C to +85°C with I<sub>rms</sub> current
4. **Storage temperature range:** Component: -40°C to +125°C  
Tray packaging: -40°C to +80°C
5. Electrical specifications at 25°C.
6. Parts in bold type are included in Coilcraft Designer's Kit P405.

## PCV-0 Series

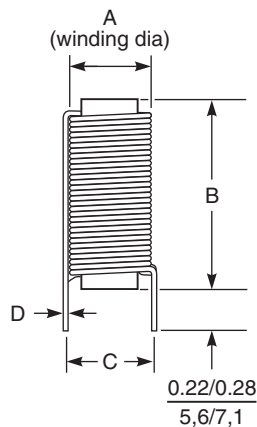

## PCV-1 Series

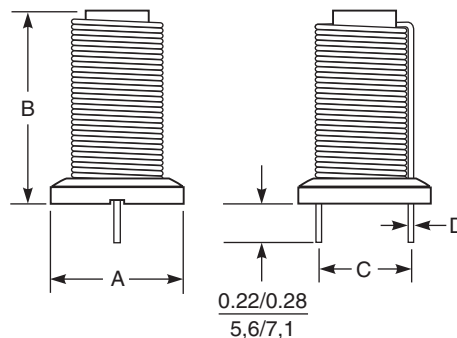

## PCV-2 Series

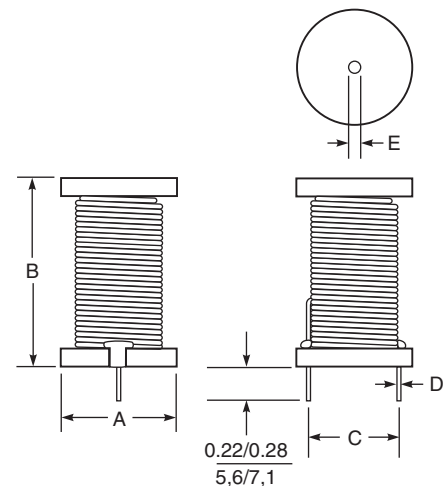

Dimensions are in  $\frac{\text{inches}}{\text{mm}}$

**Terminations:** Tin-silver over copper  
See last page for packaging information.



**US** +1-847-639-6400 sales@coilcraft.com  
**UK** +44-1236-730595 sales@coilcraft-europe.com  
**Taiwan** +886-2-2264 3646 sales@coilcraft.com.tw  
**China** +86-21-6218 8074 sales@coilcraft.com.cn  
**Singapore** + 65-6484 8412 sales@coilcraft.com.sg

Document 135-3 Revised 07/10/14  
 © Coilcraft Inc. 2014  
 This product may not be used in medical or high risk applications without prior Coilcraft approval. Specification subject to change without notice. Please check web site for latest information.



# Power Chokes – Vertical Mount

## Tray and carton packaging

Part number	Parts per tray	Maximum parts per carton	Part number	Parts per tray	Maximum parts per carton	Part number	Parts per tray	Maximum parts per carton
PCV-0-102-10L	49	245	PCV-1-103-03L	49	245	PCV-2-103-05L	49	245
PCV-0-102-25L	49	294	PCV-1-103-05L	49	245	PCV-2-103-10L	49	245
PCV-0-103-03L	49	245	PCV-1-103-10L	49	196	PCV-2-104-03L	49	245
PCV-0-103-05L	49	245	PCV-1-104-03L	49	245	PCV-2-104-05L	49	245
PCV-0-103-10L	49	196	PCV-1-104-05L	49	245	PCV-2-104-10L	49	245
PCV-0-103-20L	49	196	PCV-1-152-15L	49	245	PCV-2-105-02L	49	245
PCV-0-104-01L	49	245	PCV-1-153-10L	49	147	PCV-2-184-05L	49	245
PCV-0-104-03L	49	294	PCV-1-182-10L	49	196	PCV-2-184-10L	25	100
PCV-0-104-05L	98	392	PCV-1-182-15L	49	196	PCV-2-223-05L	49	245
PCV-0-153-03L	49	196	PCV-1-184-03L	49	196	PCV-2-223-10L	49	245
PCV-0-153-10L	49	196	PCV-1-223-03L	49	196	PCV-2-224-05L	49	245
PCV-0-154-03L	49	196	PCV-1-223-05L	49	196	PCV-2-274-03L	49	245
PCV-0-154-05L	49	245	PCV-1-223-10L	49	147	PCV-2-274-05L	49	245
PCV-0-184-05L	49	196	PCV-1-304-05L	49	245	PCV-2-274-10L	25	100
PCV-0-223-03L	49	196	PCV-1-394-05L	49	245	PCV-2-394-05L	25	125
PCV-0-223-05L	49	196	PCV-1-472-03L	49	245	PCV-2-473-05L	49	245
PCV-0-223-10L	49	147	PCV-1-472-05L	49	245	PCV-2-473-10L	49	245
PCV-0-224-03L	49	196	PCV-1-472-10L	49	196	PCV-2-564-02L	49	245
PCV-0-273-05L	49	196	PCV-1-473-03L	49	196	PCV-2-564-06L	25	100
PCV-0-274-04L	49	245	PCV-1-473-05L	49	245	PCV-2-564-08L	25	100
PCV-0-274-10L	49	245	PCV-1-473-10L	49	245	PCV-2-684-01L	49	245
PCV-0-332-10L	49	196						
PCV-0-333-12L	49	245						
PCV-0-394-03L	49	245						
PCV-0-394-05L	49	245						
PCV-0-472-03L	49	245						
PCV-0-472-05L	49	245						
PCV-0-472-10L	49	196						
PCV-0-472-20L	49	196						
PCV-0-473-03L	49	196						
PCV-0-473-05L	98	392						
PCV-0-473-10L	49	245						
PCV-0-823-03L	49	294						



www.coilcraft.com

**US** +1-847-639-6400 sales@coilcraft.com  
**UK** +44-1236-730595 sales@coilcraft-europe.com  
**Taiwan** +886-2-2264 3646 sales@coilcraft.com.tw  
**China** +86-21-6218 8074 sales@coilcraft.com.cn  
**Singapore** + 65-6484 8412 sales@coilcraft.com.sg

Document 135-4 Revised 07/10/14

© Coilcraft Inc. 2014

This product may not be used in medical or high risk applications without prior Coilcraft approval. Specification subject to change without notice. Please check web site for latest information.