

Distributed by:

**JAMECO**<sup>®</sup>  
ELECTRONICS

**www.Jameco.com ♦ 1-800-831-4242**

The content and copyrights of the attached  
material are the property of its owner.

Jameco Part Number 1539454

## COMPLEMENTARY PAIR ENHANCEMENT MODE FIELD EFFECT TRANSISTOR

NEW PRODUCT

### Features

- Low On-Resistance:  $R_{DS(ON)}$
- Low Gate Threshold Voltage
- Low Input Capacitance
- Fast Switching Speed
- Low Input/Output Leakage
- Complementary Pair
- Lead Free/RoHS Compliant (Note 2)**

### Mechanical Data

- Case: SOT-363
- Case Material: Molded Plastic. UL Flammability Classification Rating 94V-0
- Moisture Sensitivity: Level 1 per J-STD-020C
- Terminals: Solderable per MIL-STD-202, Method 208
- Lead Free Plating (Matte Tin Finish annealed over Alloy 42 leadframe). Please see Ordering Information, Note 5, on Page 5
- Terminal Connections: See Diagram
- Marking: KNP (See Page 5)
- Weight: 0.008 grams (approx.)

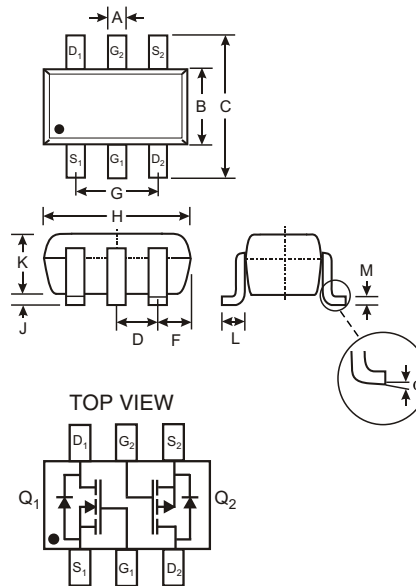

SOT-363		
Dim	Min	Max
A	0.10	0.30
B	1.15	1.35
C	2.00	2.20
D	0.65 Nominal	
F	0.30	0.40
H	1.80	2.20
J		0.10
K	0.90	1.00
L	0.25	0.40
M	0.10	0.25
	0	8°
All Dimensions in mm		

### Maximum Ratings - Total Device @ $T_A = 25\text{ C}$ unless otherwise specified

Characteristic	Symbol	Value	Units
Power Dissipation (Note 1)	$P_d$	200	mW
Thermal Resistance, Junction to Ambient	$R_{JA}$	625	°C/W
Operating and Storage Temperature Range	$T_j, T_{STG}$	-55 to +150	°C

### Maximum Ratings N-CHANNEL - $Q_1$ , 2N7002 Section @ $T_A = 25\text{ C}$ unless otherwise specified

Characteristic	Symbol	Value	Units
Drain-Source Voltage	$V_{DSS}$	60	V
Drain-Gate Voltage $R_{GS} = 1.0M$	$V_{DGR}$	60	V
Gate-Source Voltage	$V_{GSS}$	$\pm 20$ $\pm 40$	V
Drain Current (Note 1)	$I_D$	115 73 800	mA

### Maximum Ratings P-CHANNEL - $Q_2$ , BSS84 Section @ $T_A = 25\text{ C}$ unless otherwise specified

Characteristic	Symbol	Value	Units
Drain-Source Voltage	$V_{DSS}$	-50	V
Drain-Gate Voltage $R_{GS} = 20K$	$V_{DGR}$	-50	V
Gate-Source Voltage	$V_{GSS}$	20	V
Drain Current (Note 1)	$I_D$	-130	mA

- Note: 1. Device mounted on FR-4 PCB, 1 inch x 0.85 inch x 0.062 inch; pad layout as shown on Diodes Inc. suggested pad layout document AP02001, which can be found on our website at <http://www.diodes.com/datasheets/ap02001.pdf>.  
 2. No purposefully added lead.

### Electrical Characteristics N-CHANNEL - Q<sub>1</sub>, 2N7002 Section @ T<sub>A</sub> = 25 C unless otherwise specified

Characteristic	Symbol	Min	Typ	Max	Unit	Test Condition
<b>OFF CHARACTERISTICS (Note 3)</b>						
Drain-Source Breakdown Voltage	BV <sub>DSS</sub>	60	70		V	V <sub>GS</sub> = 0V, I <sub>D</sub> = 10 A
Zero Gate Voltage Drain Current	I <sub>DSS</sub>			1.0 500	μA	V <sub>DS</sub> = 60V, V <sub>GS</sub> = 0V @ T <sub>C</sub> = 25°C @ T <sub>C</sub> = 125°C
Gate-Body Leakage	I <sub>GSS</sub>			±10	nA	V <sub>GS</sub> = ±20V, V <sub>DS</sub> = 0V
<b>ON CHARACTERISTICS (Note 3)</b>						
Gate Threshold Voltage	V <sub>GS(th)</sub>	1.0		2.5	V	V <sub>DS</sub> = V <sub>GS</sub> , I <sub>D</sub> = 250 A
Static Drain-Source On-Resistance	R <sub>DS(ON)</sub>		3.2 4.4	7.5 13.5		V <sub>GS</sub> = 5.0V, I <sub>D</sub> = 0.05A V <sub>GS</sub> = 10V, I <sub>D</sub> = 0.5A @ T <sub>J</sub> = 25°C @ T <sub>J</sub> = 125°C
On-State Drain Current	I <sub>D(ON)</sub>	0.5	1.0		A	V <sub>GS</sub> = 10V, V <sub>DS</sub> = 7.5V
Forward Transconductance	g <sub>FS</sub>	80			mS	V <sub>DS</sub> = 10V, I <sub>D</sub> = 0.2A
<b>DYNAMIC CHARACTERISTICS</b>						
Input Capacitance	C <sub>iss</sub>		22	50	pF	V <sub>DS</sub> = 25V, V <sub>GS</sub> = 0V f = 1.0MHz
Output Capacitance	C <sub>oss</sub>		11	25	pF	
Reverse Transfer Capacitance	C <sub>rss</sub>		2.0	5.0	pF	
<b>SWITCHING CHARACTERISTICS</b>						
Turn-On Delay Time	t <sub>D(ON)</sub>		7.0	20	ns	V <sub>DD</sub> = 30V, I <sub>D</sub> = 0.2A, R <sub>L</sub> = 150 Ω, V <sub>GEN</sub> = 10V, R <sub>GEN</sub> = 25 Ω
Turn-Off Delay Time	t <sub>D(OFF)</sub>		11	20	ns	

### Electrical Characteristics P-CHANNEL - Q<sub>2</sub>, BSS84 Section @ T<sub>A</sub> = 25 C unless otherwise specified

Characteristic	Symbol	Min	Typ	Max	Unit	Test Condition
<b>OFF CHARACTERISTICS (Note 3)</b>						
Drain-Source Breakdown Voltage	BV <sub>DSS</sub>	-50			V	V <sub>GS</sub> = 0V, I <sub>D</sub> = -250μA
Zero Gate Voltage Drain Current	I <sub>DSS</sub>			-15 -60 -100	μA μA nA	V <sub>DS</sub> = -50V, V <sub>GS</sub> = 0V, T <sub>J</sub> = 25 C V <sub>DS</sub> = -50V, V <sub>GS</sub> = 0V, T <sub>J</sub> = 125 C V <sub>DS</sub> = -25V, V <sub>GS</sub> = 0V, T <sub>J</sub> = 25 C
Gate-Body Leakage	I <sub>GSS</sub>			10	nA	V <sub>GS</sub> = 20V, V <sub>DS</sub> = 0V
<b>ON CHARACTERISTICS (Note 3)</b>						
Gate Threshold Voltage	V <sub>GS(th)</sub>	-0.8		-2.0	V	V <sub>DS</sub> = V <sub>GS</sub> , I <sub>D</sub> = -1mA
Static Drain-Source On-Resistance	R <sub>DS(ON)</sub>			10		V <sub>GS</sub> = -5V, I <sub>D</sub> = -0.100A
Forward Transconductance	g <sub>FS</sub>	.05			S	V <sub>DS</sub> = -25V, I <sub>D</sub> = -0.1A
<b>DYNAMIC CHARACTERISTICS</b>						
Input Capacitance	C <sub>iss</sub>			45	pF	V <sub>DS</sub> = -25V, V <sub>GS</sub> = 0V f = 1.0MHz
Output Capacitance	C <sub>oss</sub>			25	pF	
Reverse Transfer Capacitance	C <sub>rss</sub>			12	pF	
<b>SWITCHING CHARACTERISTICS</b>						
Turn-On Delay Time	t <sub>D(ON)</sub>		10		ns	V <sub>DD</sub> = -30V, I <sub>D</sub> = -0.27A, R <sub>GEN</sub> = 50 Ω, V <sub>GS</sub> = -10V
Turn-Off Delay Time	t <sub>D(OFF)</sub>		18		ns	

Note: 3. Short duration test pulse used to minimize self-heating effect.

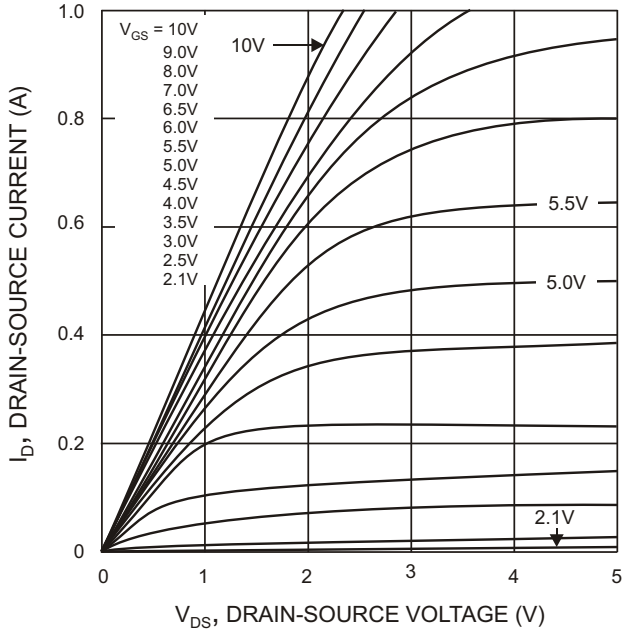

$V_{GS}$ , DRAIN-SOURCE VOLTAGE (V)  
Fig. 1 On-Region Characteristics

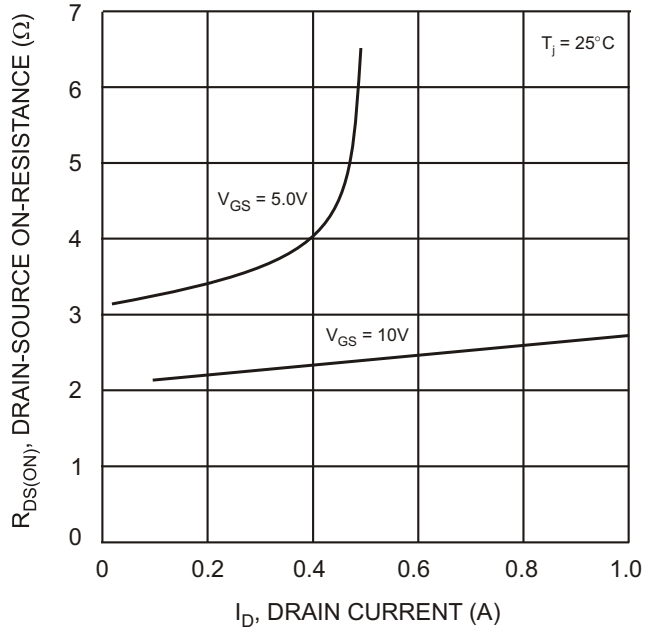

$T_J = 25^\circ\text{C}$   
 $V_{GS} = 5.0\text{V}$   
 $V_{GS} = 10\text{V}$   
 $I_D$ , DRAIN CURRENT (A)  
Fig. 2 On-Resistance vs Drain Current

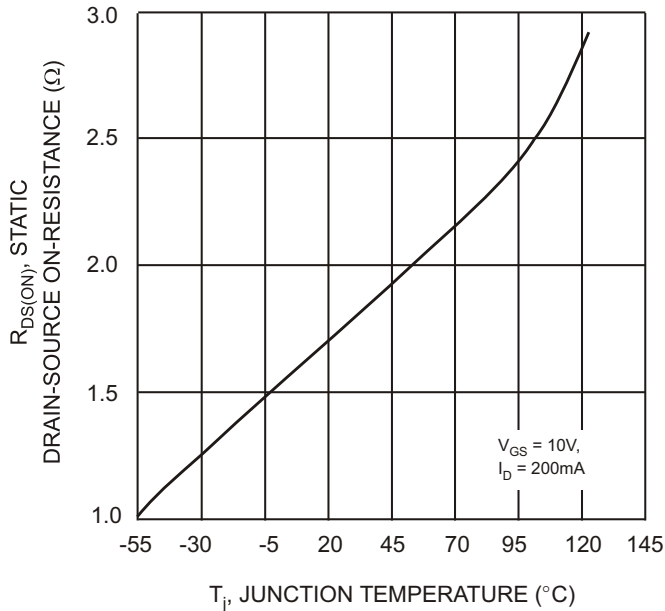

$T_J$ , JUNCTION TEMPERATURE ( $^\circ\text{C}$ )  
Fig. 3 On-Resistance vs Junction Temperature

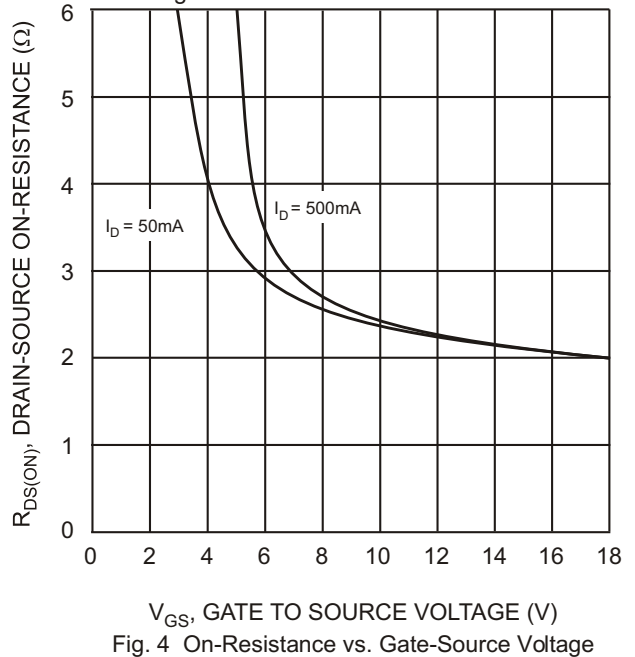

$V_{GS}$ , GATE TO SOURCE VOLTAGE (V)  
Fig. 4 On-Resistance vs. Gate-Source Voltage

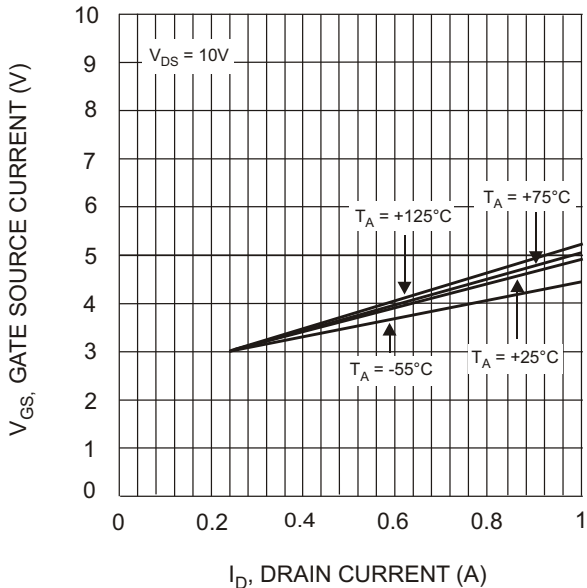

$V_{GS}$ , GATE SOURCE VOLTAGE (V)  
 $V_{DS} = 10\text{V}$   
 $T_A = +125^\circ\text{C}$   
 $T_A = +75^\circ\text{C}$   
 $T_A = +25^\circ\text{C}$   
 $T_A = -55^\circ\text{C}$   
 $I_D$ , DRAIN CURRENT (A)  
Fig. 5 Typical Transfer Characteristics

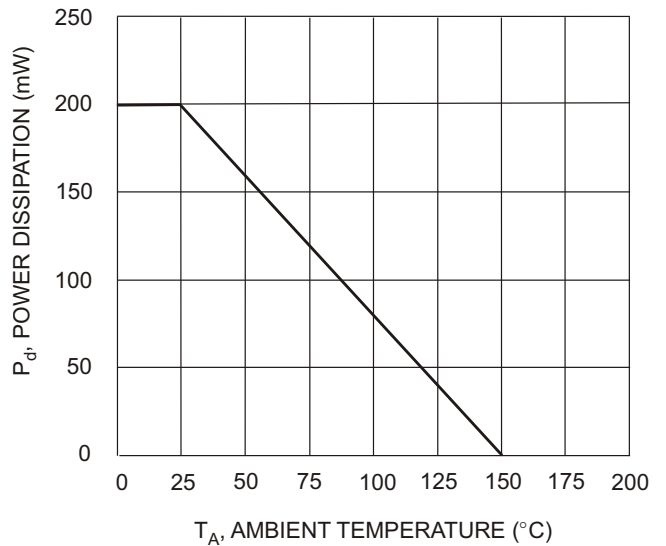

$P_D$ , POWER DISSIPATION (mW)  
 $T_A$ , AMBIENT TEMPERATURE ( $^\circ\text{C}$ )  
Fig. 6 Max Power Dissipation vs. Ambient Temperature

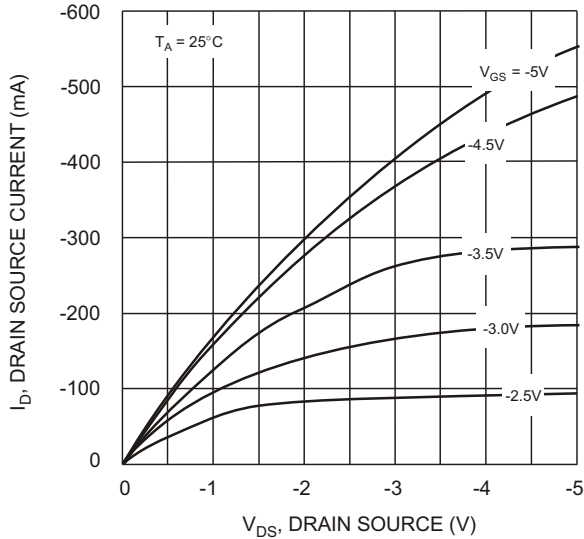

Fig. 7, Drain Source Current vs. Drain Source Voltage

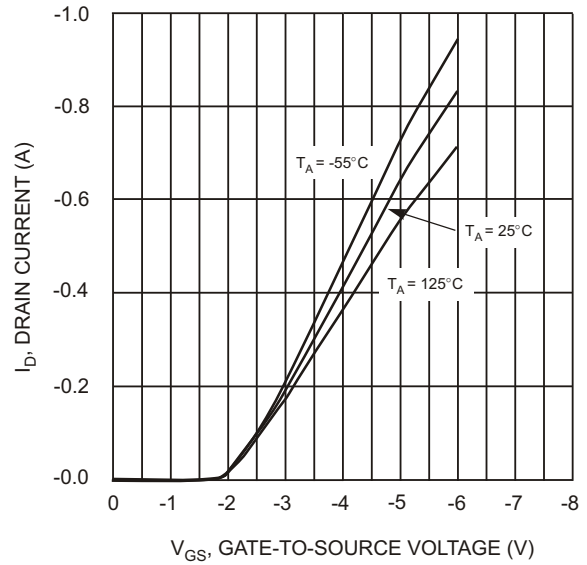

Fig. 8, Drain Current vs. Gate Source Voltage

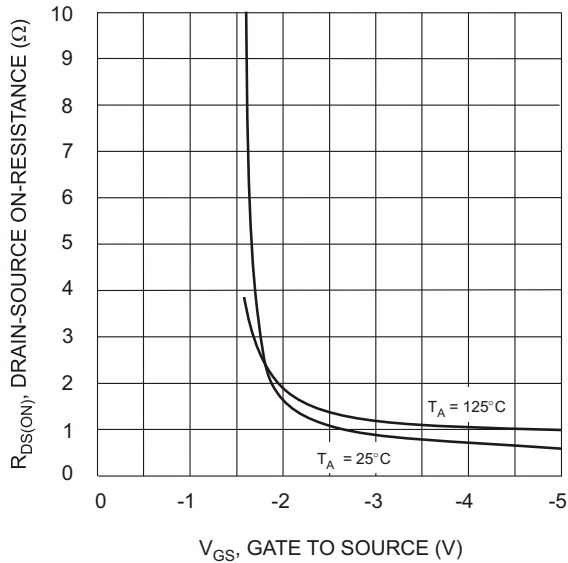

Fig. 9, On Resistance vs. Gate Source Voltage

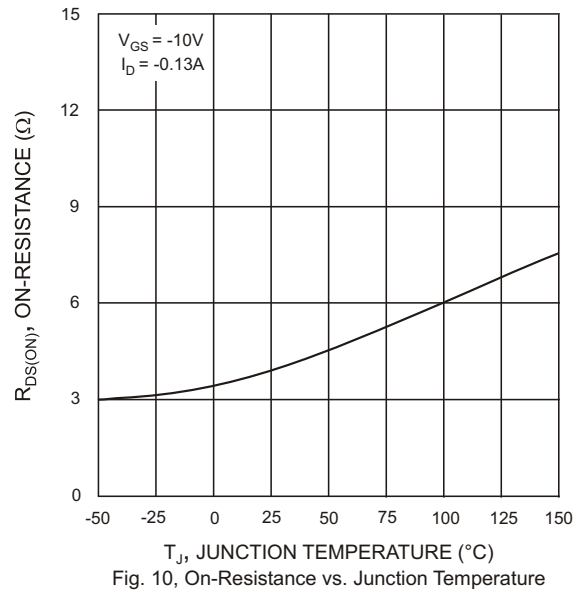

Fig. 10, On-Resistance vs. Junction Temperature

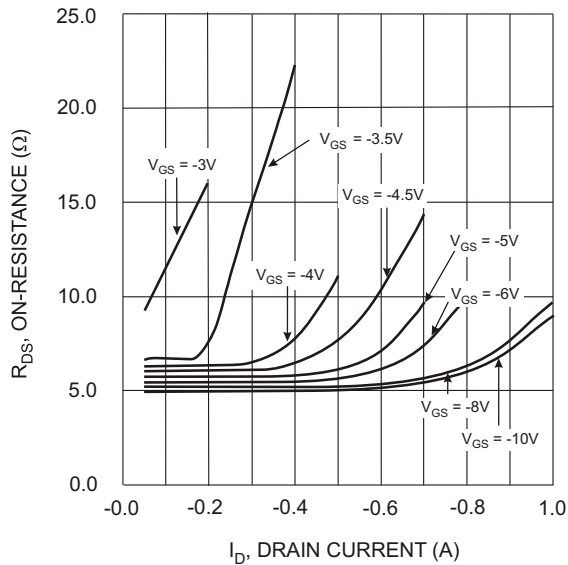

Fig. 11, On-Resistance vs. Drain Current

**Ordering Information** (Note 4)

Device	Packaging	Shipping
BSS8402DW-7-F	SOT-363	3000/Tape & Reel

Notes: 4. For Packaging Details, go to our website at <http://www.diodes.com/datasheets/ap02007.pdf>.

**Marking Information**

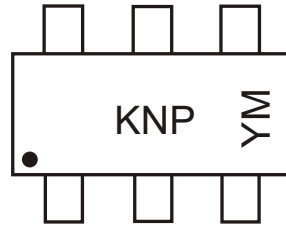

KNP = Product Type Marking Code  
 YM = Date Code Marking  
 Y = Year ex: R = 2004  
 M = Month ex: 9 = September

Date Code Key

Year	2003	2004	2005	2006	2007	2008	2009
Code	P	R	S	T	U	V	W

Month	Jan	Feb	March	Apr	May	Jun	Jul	Aug	Sep	Oct	Nov	Dec
Code	1	2	3	4	5	6	7	8	9	O	N	D

**IMPORTANT NOTICE**

Diodes, Inc. and its subsidiaries reserve the right to make changes without further notice to any product herein to make corrections, modifications, enhancements, improvements, or other changes. Diodes, Inc. does not assume any liability arising out of the application or use of any product described herein; neither does it convey any license under its patent rights, nor the rights of others. The user of products in such applications shall assume all risks of such use and will agree to hold Diodes Incorporated and all the companies whose products are represented on our website, harmless against all damages.

**LIFE SUPPORT**

The products located on our website at [www.diodes.com](http://www.diodes.com) are not recommended for use in life support systems where a failure or malfunction of the component may directly threaten life or cause injury without the express written approval of Diodes Incorporated.