

PNP Silicon Darlington Transistor

- High collector current
- Low collector-emitter saturation voltage
- Complementary types: BSP50...BSP52 (NPN)
- Pb-free (RoHS compliant) package ¹⁾
- Qualified according AEC Q101

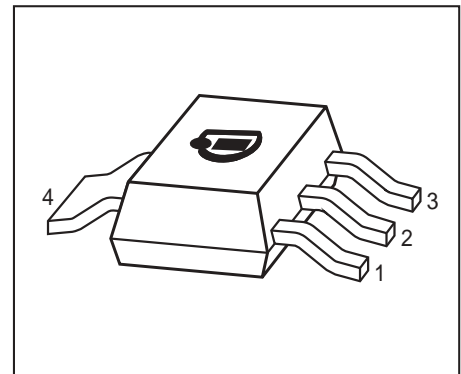

Type	Marking	Pin Configuration						Package
		1=B	2=C	3=E	4=C	-	-	
BSP60	BSP60	1=B	2=C	3=E	4=C	-	-	SOT223
BSP61	BSP61	1=B	2=C	3=E	4=C	-	-	SOT223
BSP62	BSP62	1=B	2=C	3=E	4=C	-	-	SOT223

Maximum Ratings

Parameter	Symbol	Value	Unit
Collector-emitter voltage	V_{CEO}		V
BSP60		45	
BSP61		60	
BSP62		80	
Collector-base voltage	V_{CBO}		
BSP60		60	
BSP61		80	
BSP62		90	
Emitter-base voltage	V_{EBO}	5	
Collector current	I_C	1	A
Peak collector current	I_{CM}	2	
Base current	I_B	100	mA
Total power dissipation- $T_S \leq 124 \text{ }^\circ\text{C}$	P_{tot}	1.5	W
Junction temperature	T_j	150	$^\circ\text{C}$
Storage temperature	T_{stg}	-65 ... 150	

¹Pb-containing package may be available upon special request

Thermal Resistance

Parameter	Symbol	Value	Unit
Junction - soldering point ¹⁾	R_{thJS}	≤ 17	K/W

Electrical Characteristics at $T_A = 25^\circ\text{C}$, unless otherwise specified

Parameter	Symbol	Values			Unit
		min.	typ.	max.	

DC Characteristics

Collector-emitter breakdown voltage $I_C = 10 \text{ mA}$, $I_B = 0$, BSP60 $I_C = 10 \text{ mA}$, $I_B = 0$, BSP61 $I_C = 10 \text{ mA}$, $I_B = 0$, BCP62	$V_{(BR)CEO}$	45 60 80	- - -	- - -	V
Collector-base breakdown voltage $I_C = 100 \mu\text{A}$, $I_E = 0$, BSP60 $I_C = 100 \mu\text{A}$, $I_E = 0$, BSP61 $I_C = 100 \mu\text{A}$, $I_E = 0$, BSP62	$V_{(BR)CBO}$	60 80 90	- - -	- - -	
Emitter-base breakdown voltage $I_E = 100 \mu\text{A}$, $I_C = 0$	$V_{(BR)EBO}$	5	-	-	
Collector-emitter cutoff current $V_{CE} = V_{CE0max}$, $V_{BE} = 0$	I_{CES}	-	-	10	μA
Emitter-base cutoff current $V_{EB} = 4 \text{ V}$, $I_C = 0$	I_{EBO}	-	-	10	μA
DC current gain ²⁾ $I_C = 150 \text{ mA}$, $V_{CE} = 10 \text{ V}$ $I_C = 500 \text{ mA}$, $V_{CE} = 10 \text{ V}$	h_{FE}	1000 2000	- -	- -	-
Collector-emitter saturation voltage ²⁾ $I_C = 500 \text{ mA}$, $I_B = 0.55 \text{ mA}$ $I_C = 1 \text{ A}$, $I_B = 1 \text{ mA}$	V_{CEsat}	- -	- -	1.3 1.8	V
Base emitter saturation voltage ²⁾ $I_C = 500 \text{ mA}$, $I_B = 0.5 \text{ mA}$ $I_C = 1 \text{ A}$, $I_B = 1 \text{ mA}$	V_{BEsat}	- -	- -	1.9 2.2	

AC Characteristics

Transition frequency $I_C = 100 \text{ mA}$, $V_{CE} = 5 \text{ V}$, $f = 100 \text{ MHz}$	f_T	-	200	-	MHz
---	-------	---	-----	---	-----

¹⁾For calculation of R_{thJA} please refer to Application Note Thermal Resistance

²⁾Pulse test: $t < 300 \mu\text{s}$; $D < 2\%$

Switching time test circuit

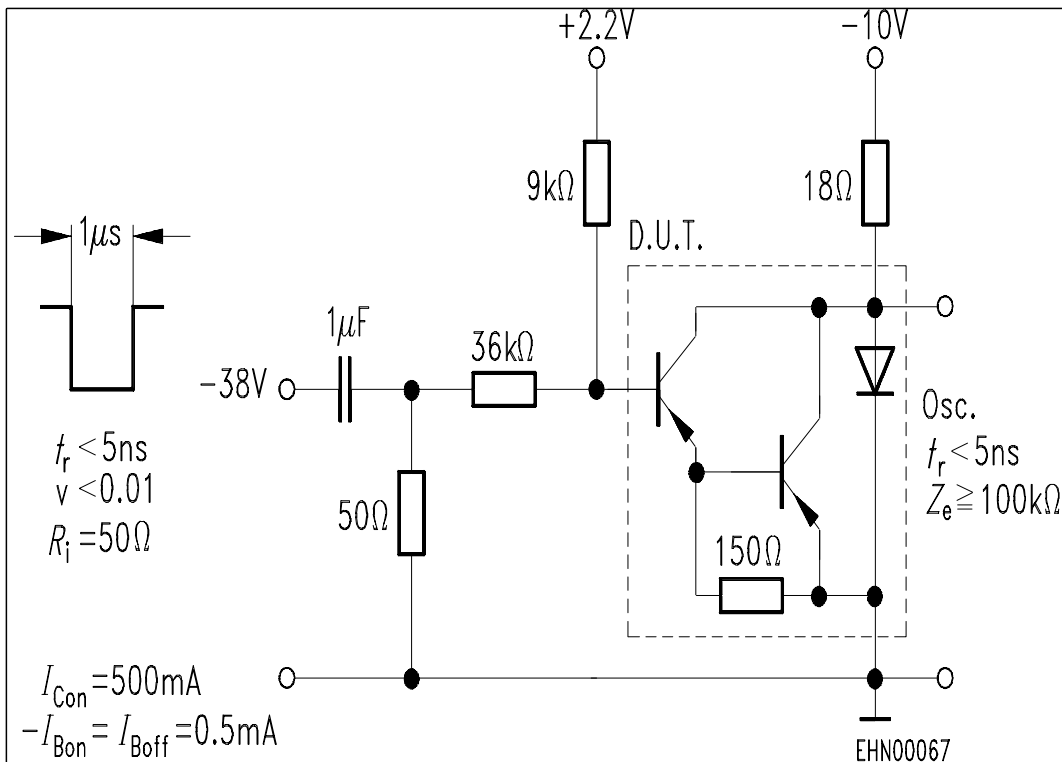

Switching time waveform

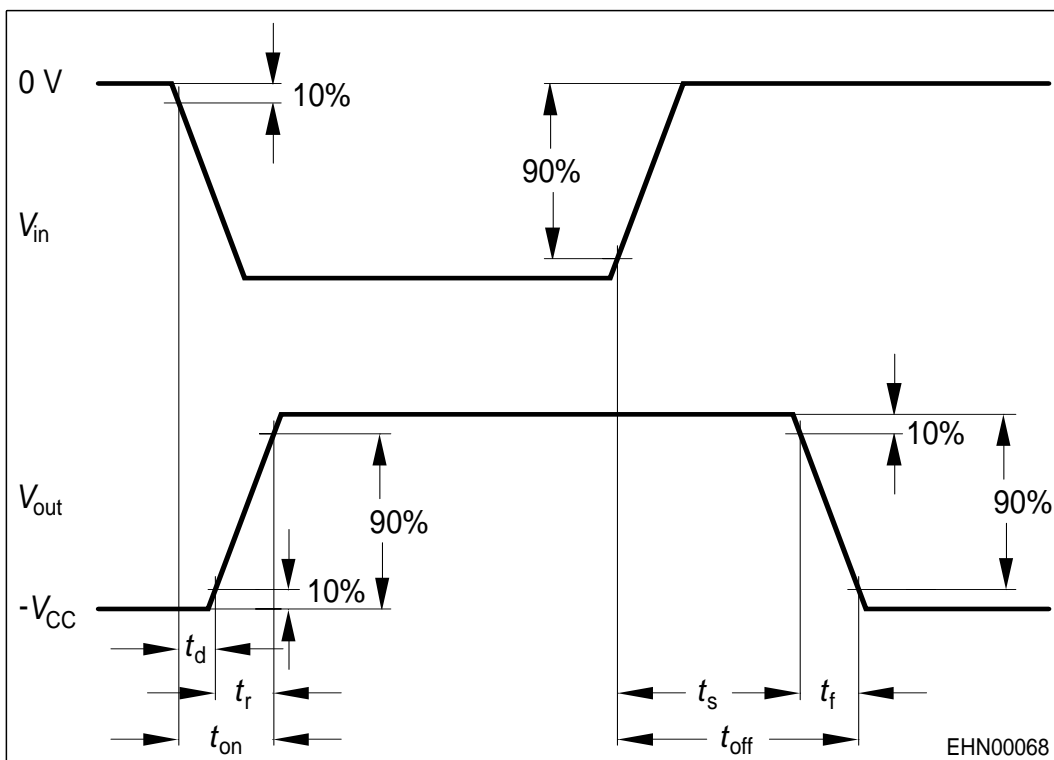

DC current gain $h_{FE} = f(I_C)$

$V_{CE} = 10\text{ V}$

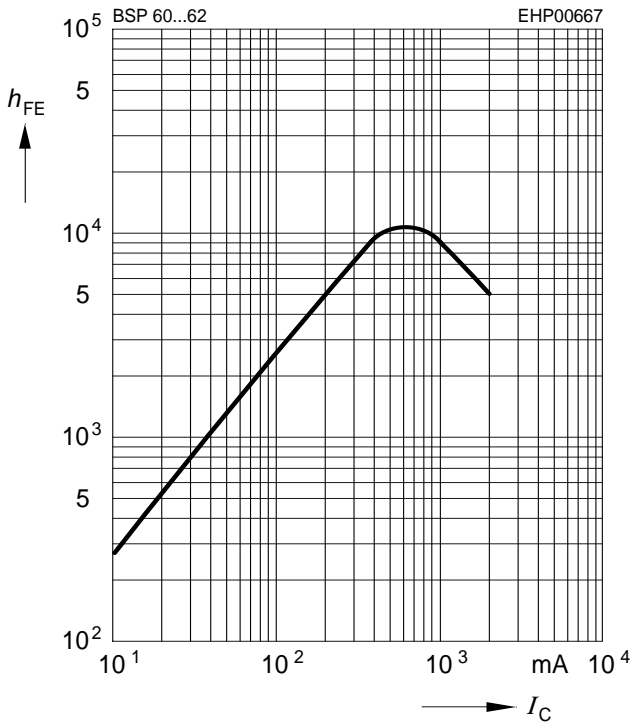

Collector-emitter saturation voltage

$I_C = f(V_{CEsat}), I_B = \text{Parameter}$

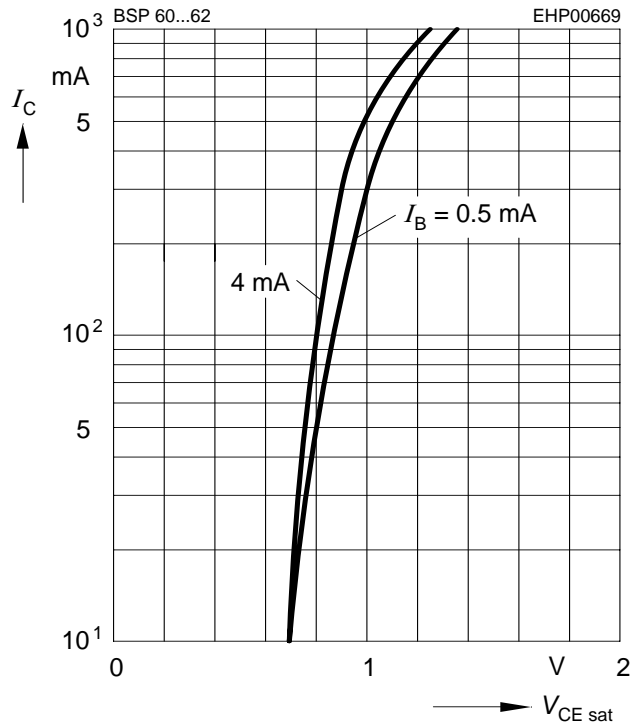

Base-emitter saturation voltage

$I_C = f(V_{BEsat}), I_B = \text{Parameter}$

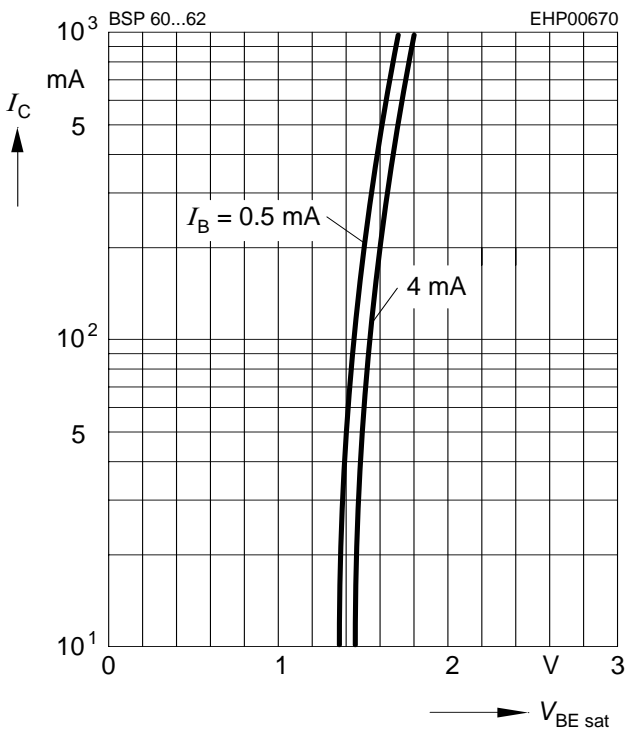

Transition frequency $f_T = f(I_C)$

$V_{CE} = 10\text{ V}, f = 100\text{ MHz}$

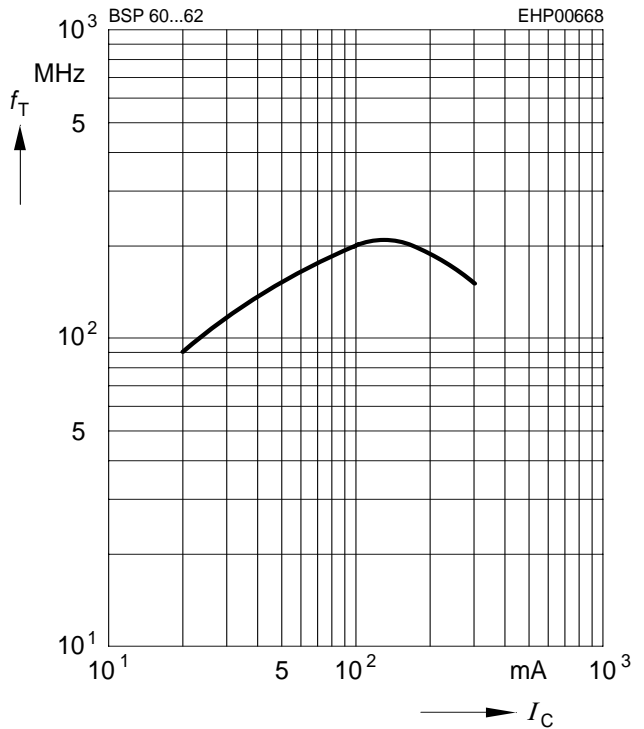

Collector-base capacitance $C_{cb} = f(V_{CB})$

Emitter-base capacitance $C_{eb} = f(V_{EB})$

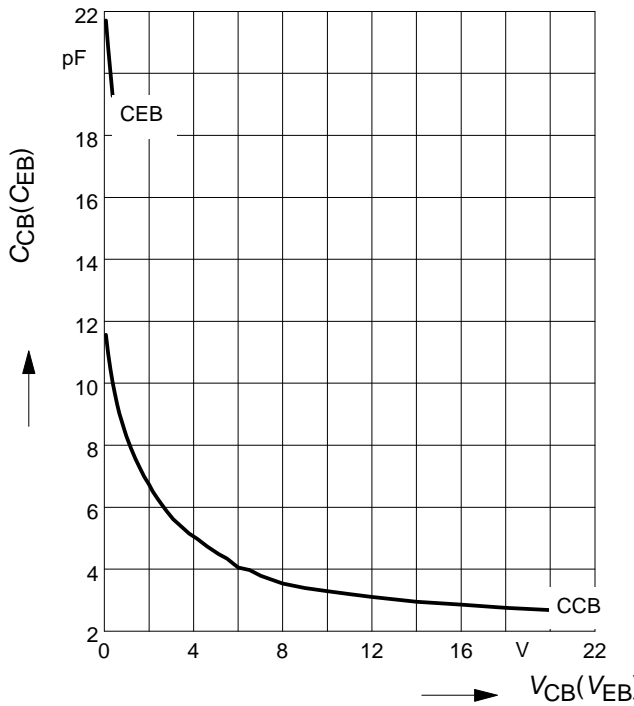

Total power dissipation $P_{tot} = f(T_S)$

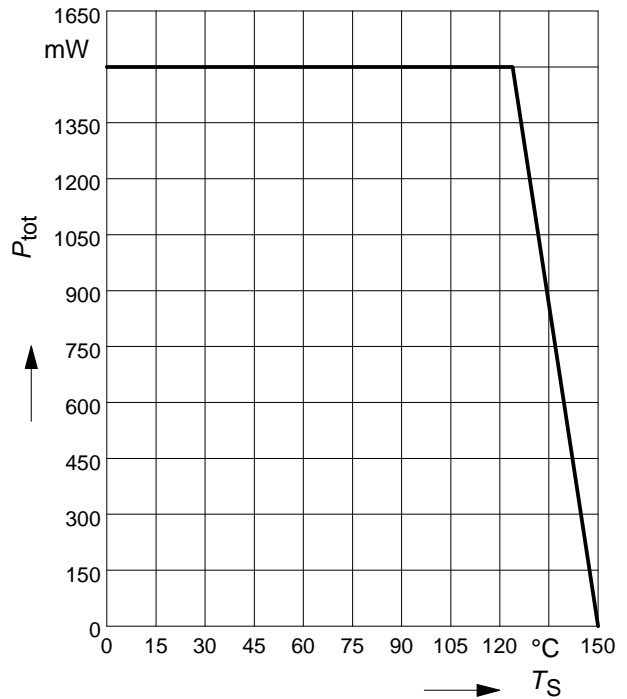

Permissible Pulse Load

$P_{totmax}/P_{totDC} = f(t_p)$

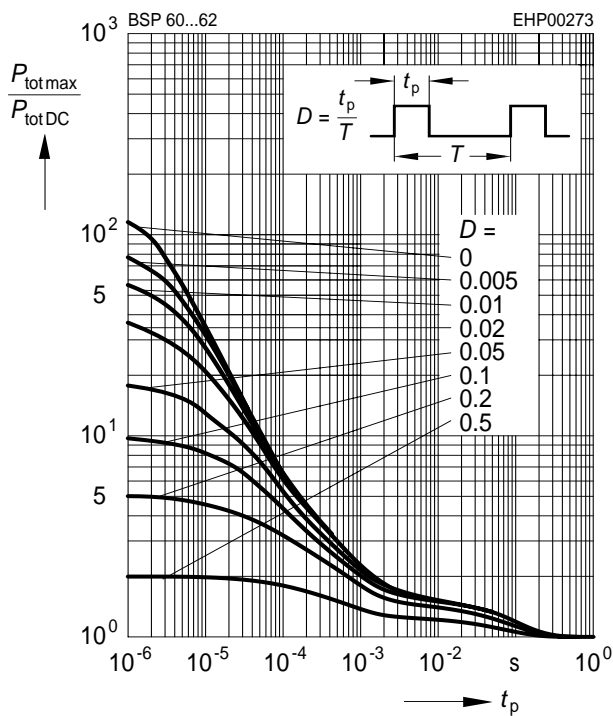

External resistance $R_{BE} = f(T_A)^{**}$

$V_{CB} = V_{CEmax}$

** R_{BEmax} for thermal stability

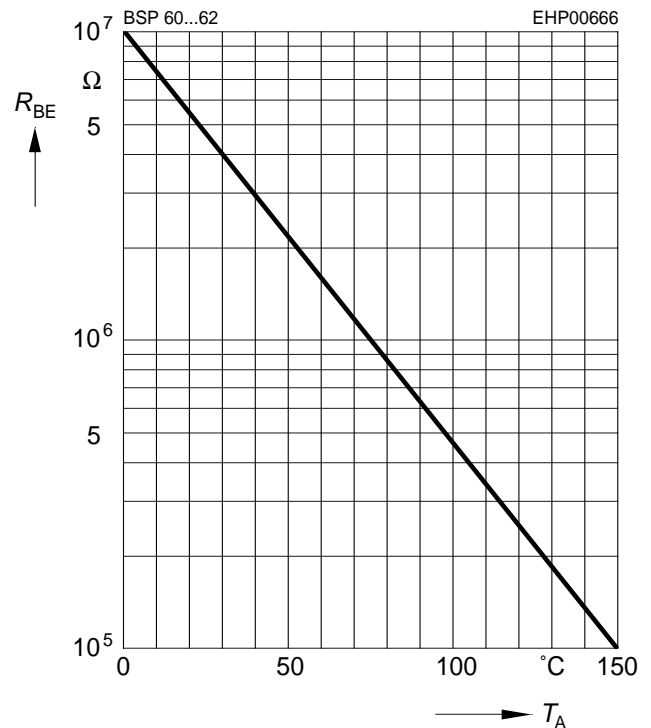

Package Outline

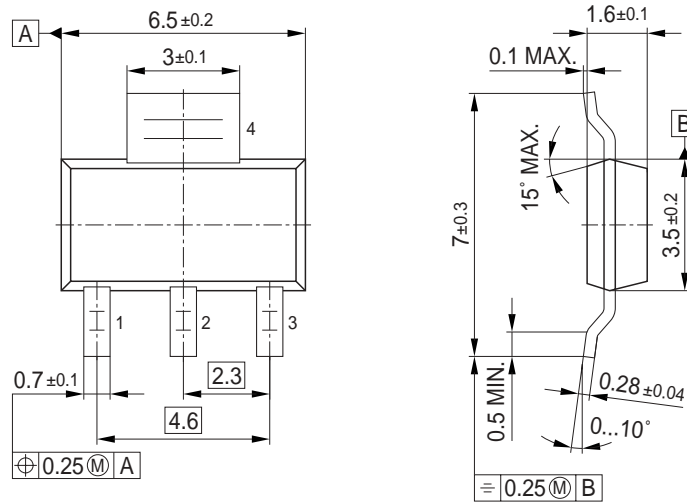

Foot Print

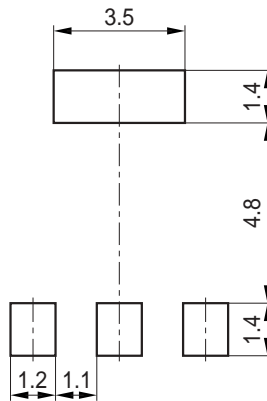

Marking Layout (Example)

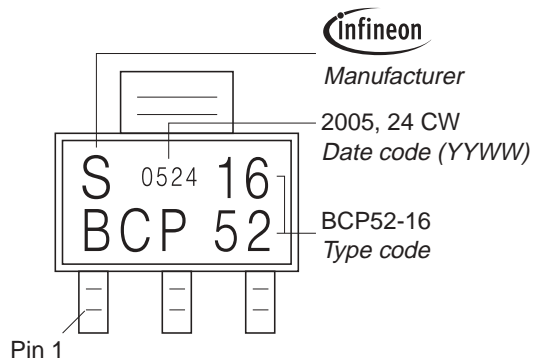

Packing

Reel $\varnothing 180 \text{ mm}$ = 1.000 Pieces/Reel
 Reel $\varnothing 330 \text{ mm}$ = 4.000 Pieces/Reel

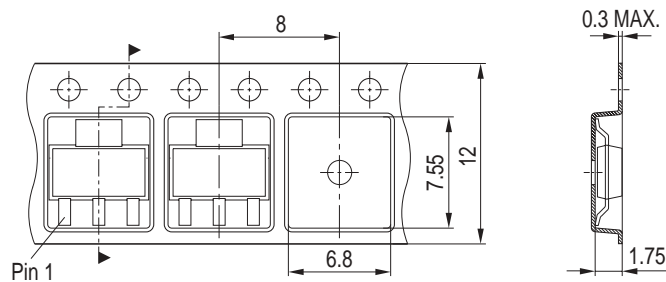

Edition 2006-02-01

Published by

Infineon Technologies AG

81726 München, Germany

© Infineon Technologies AG 2007.

All Rights Reserved.

Attention please!

The information given in this dokument shall in no event be regarded as a guarantee of conditions or characteristics ("Beschaffenheitsgarantie"). With respect to any examples or hints given herein, any typical values stated herein and/or any information regarding the application of the device, Infineon Technologies hereby disclaims any and all warranties and liabilities of any kind, including without limitation warranties of non-infringement of intellectual property rights of any third party.

Information

For further information on technology, delivery terms and conditions and prices please contact your nearest Infineon Technologies Office (www.infineon.com).

Warnings

Due to technical requirements components may contain dangerous substances. For information on the types in question please contact your nearest Infineon Technologies Office.

Infineon Technologies Components may only be used in life-support devices or systems with the express written approval of Infineon Technologies, if a failure of such components can reasonably be expected to cause the failure of that life-support device or system, or to affect the safety or effectiveness of that device or system.

Life support devices or systems are intended to be implanted in the human body, or to support and/or maintain and sustain and/or protect human life. If they fail, it is reasonable to assume that the health of the user or other persons may be endangered.