

Serial Lite III Streaming Intel FPGA IP Core User Guide

Updated for Intel® Quartus® Prime Design Suite: **18.1.1**

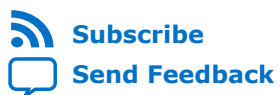

[Subscribe](#)

[Send Feedback](#)

UG-01126 | 2020.05.05

Latest document on the web: [PDF](#) | [HTML](#)

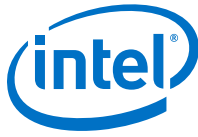

Contents

- 1. Serial Lite III Streaming Intel FPGA IP Core Quick Reference..... 4**
- 2. About the Serial Lite III Streaming IP Core..... 6**
 - 2.1. Serial Lite III Streaming IP Core Protocol.....6
 - 2.2. Serial Lite III Streaming IP Core Protocol Operating Modes.....7
 - 2.2.1. Continuous Mode..... 7
 - 2.2.2. Burst Mode..... 8
 - 2.3. Performance and Resource Utilization..... 8
- 3. Getting Started 12**
 - 3.1. Installing and Licensing Intel FPGA IP Cores..... 12
 - 3.2. Intel FPGA IP Evaluation Mode..... 13
 - 3.2.1. Intel FPGA IP Evaluation Mode Timeout Behavior.....15
 - 3.3. Specifying IP Core Parameters and Options..... 15
 - 3.3.1. Serial Lite III Streaming IP Core Parameter Editor..... 16
 - 3.3.2. Intel Arria 10 Designs.....16
 - 3.4. Serial Lite III Streaming IP Core Parameters.....17
 - 3.4.1. Parameter Settings for Intel Stratix 10 Devices..... 17
 - 3.4.2. Parameter Settings for Intel Arria 10 Devices.....19
 - 3.4.3. Parameter Settings for Stratix V and Arria V GZ Devices.....21
 - 3.5. Transceiver Reconfiguration Controller for Stratix V and Arria V GZ Designs..... 22
 - 3.6. IP Core Generation Output (Intel Quartus Prime Pro Edition).....22
 - 3.7. IP Core Generation Output (Intel Quartus Prime Standard Edition)..... 25
 - 3.8. Simulating..... 26
 - 3.8.1. Simulating Intel FPGA IP Cores..... 26
 - 3.8.2. Simulation Parameters.....26
 - 3.8.3. Simulating and Verifying the Design..... 28
- 4. Serial Lite III Streaming IP Core Design Examples..... 30**
 - 4.1. Serial Lite III Streaming IP Core Design Example for Intel Stratix 10 Devices.....30
 - 4.2. Serial Lite III Streaming IP Core Design Example for Intel Arria 10 Devices..... 30
 - 4.3. Serial Lite III Streaming IP Design Examples for Stratix V Devices.....30
- 5. Serial Lite III Streaming IP Core Functional Description.....31**
 - 5.1. IP Core Architecture..... 31
 - 5.1.1. Serial Lite III Streaming Source Core.....32
 - 5.1.2. Serial Lite III Streaming Sink Core..... 35
 - 5.1.3. Serial Lite III Streaming IP Core Duplex Core..... 37
 - 5.1.4. Interlaken PHY IP Duplex Core or Native PHY IP Duplex Core - Interlaken Mode or PCS Gearbox Mode.....37
 - 5.1.5. Intel Stratix 10, Intel Arria 10, Stratix V, and Arria V GZ Variations..... 38
 - 5.2. Transmission Overheads and Lane Rate Calculations..... 39
 - 5.3. Reset..... 40
 - 5.4. Link-Up Sequence..... 41
 - 5.5. Error Detection, Reporting, and Recovering Mechanism..... 44
 - 5.6. CRC-32 Error Injection 49
 - 5.7. FIFO ECC Protection 49
 - 5.8. User Data Interface Waveforms..... 49



5.9. Signals.....	52
5.9.1. Signals for Intel Stratix 10 Devices.....	52
5.9.2. Signals for Intel Arria 10 Devices.....	60
5.9.3. Signals for Stratix V and Arria V GZ Devices.....	67
5.10. Accessing Configuration and Status Registers.....	74
6. Serial Lite III Streaming IP Core Clocking Guidelines.....	75
6.1. Standard Clocking Mode.....	75
6.1.1. Standard Clocking Mode in Serial Lite III Streaming Intel FPGA IP Core (Intel Stratix 10 Devices).....	75
6.1.2. Standard Clocking Mode in Intel Arria 10, Stratix V, and Arria V Devices	79
6.2. Advanced Clocking Mode.....	82
6.2.1. Advanced Clocking Mode Structure for Serial Lite III Streaming Intel FPGA IP Core (Intel Stratix 10 Devices).....	82
6.2.2. Advanced Clocking Mode Structure For Intel Arria 10, Stratix V, and Arria V Devices.....	85
6.3. Standard Clocking Mode vs Advanced Clocking Mode.....	88
6.4. Clocking Implementation Guidelines.....	89
6.4.1. Choosing TX PLL Type.....	91
6.5. Core Latency.....	93
7. Serial Lite III Streaming IP Core Configuration and Status Registers.....	95
7.1. Register Map.....	95
7.2. Configuration and Status Registers.....	95
8. Serial Lite III Streaming IP Core Debugging Guidelines.....	102
8.1. Creating a Signal Tap Debug File to Match Your Design Hierarchy	102
8.2. Serial Lite III Streaming IP Core Link Debugging.....	103
8.2.1. Source Core Link Debugging	103
8.2.2. Sink Core Link Debugging	104
9. Serial Lite III Streaming IP Core User Guide Archives.....	106
10. Document Revision History for the Intel FPGA Serial Lite III Streaming IP Core User Guide.....	107

1. Serial Lite III Streaming Intel FPGA IP Core Quick Reference

The Serial Lite III Streaming Intel® FPGA IP core is a lightweight protocol suitable for high bandwidth streaming data in chip-to-chip, board-to-board, and backplane applications.

Table 1. Serial Lite III Streaming IP Core

Item		Description
Release Information	Version	18.1.1 Intel Quartus® Prime Pro Edition (Intel Stratix® 10 and Intel Arria® 10 devices) 18.1 Intel Quartus Prime Standard Edition (Intel Arria 10, Stratix V and Arria V GZ devices)
	Release Date	December 2018 (Intel Quartus Prime Pro Edition v18.1.1) September 2018 (Intel Quartus Prime Standard Edition v18.1)
	IP Catalog Name	<ul style="list-style-type: none"> Serial Lite III Streaming Intel FPGA IP (Intel Stratix 10, Stratix V, and Arria V GZ devices) Serial Lite III Streaming Intel Arria 10 FPGA IP
	Ordering Code	IP-SLITE3/ST
	Product ID	010A
	Vendor ID	6AF7
IP Core Information	Core Features	<ul style="list-style-type: none"> Up to 28 Gbps⁽¹⁾ lane data rate for Intel Stratix 10 with H-tile or E-tile transceivers. Up to 17.4 Gbps lane data rates for Intel Arria 10 devices. Supports 1–24 serial lanes in configurations that provide nominal bandwidths from 3.125 gigabits per second (Gbps) to over 400 Gbps.
	Protocol Features	<ul style="list-style-type: none"> Source (simplex transmitter), sink (simplex receiver), and duplex operations Support for single or multiple lanes 64/67B physical layer encoding Payload and idle scrambling Error detection Low overhead framing Low point-to-point transfer latency
	Typical Application	<ul style="list-style-type: none"> High resolution video Radar processing Medical imaging Baseband processing in wireless infrastructure
	Device Family Support	Intel Stratix 10 (Advance support), Intel Arria 10 (Final support) , Arria V GZ (Final support), and Stratix V (Final support) FPGA devices.

continued...

⁽¹⁾ Refer to [Table 2](#) on page 8, [Table 4](#) on page 9, and [Table 5](#) on page 10 for maximum lane supported per data rate.



Item	Description
	<p>Advance support - The IP core is available for simulation and compilation for this device family. FPGA programming file (.pof) support is not available for Quartus Prime Pro – Stratix 10 Edition Beta software and as such IP timing closure cannot be guaranteed. Timing models include initial engineering estimates of delays based on early post-layout information. The timing models are subject to change as silicon testing improves the correlation between the actual silicon and the timing models. You can use this IP core for system architecture and resource utilization studies, simulation, pinout, system latency assessments, basic timing assessments (pipeline budgeting), and I/O transfer strategy (data-path width, burst depth, I/O standards tradeoffs).</p> <p>Final support - The IP core is verified with final timing models for this device family. The IP core meets all the functional and timing requirements for the device family and can be used in production designs.</p>
Design Tools	<ul style="list-style-type: none"> • IP parameter editor in the Intel Quartus Prime software for IP design instantiation and compilation • Timing Analyzer in the Intel Quartus Prime software for timing analysis • ModelSim-Intel FPGA Edition, MATLAB, or third-party tool using NativeLink for design simulation or synthesis

Related Information

- [Intel Software Installation and Licensing](#)
- [What's New in Intel IP](#)
- [Serial Lite III Streaming Intel FPGA IP Core Release Notes](#)
- [Errata for Intel FPGA Serial Lite III Streaming IP core in the Knowledge Base](#)
- [Serial Lite III Streaming IP Core User Guide Archives on page 106](#)
Provides a list of user guides for previous versions of the Intel FPGA Serial Lite III Streaming IP core.
- [Timing and Power Models](#)
Reports the default device support levels in the current version of the Quartus Prime Pro Edition software.
- [Timing and Power Models](#)
Reports the default device support levels in the current version of the Quartus Prime Standard Edition software.
- [Intel FPGA Serial Lite III Streaming IP Core Design Example User Guide for Intel Stratix 10 Devices](#)
- [Intel Arria 10 Serial Lite III Streaming IP Core Design Example User Guide](#)

2. About the Serial Lite III Streaming IP Core

The Serial Lite III Streaming IP core is a high-speed serial communication protocol for chip-to-chip, board-to-board, and backplane application data transfers. This protocol offers high bandwidth, low overhead frames, low I/O count, and supports scalability in both number of lanes and lane speed.

The Serial Lite III Streaming IP core incorporates a media access control (MAC) block, a physical coding sublayer (PCS), and a physical media attachment (PMA). The IP core transmits and receives streaming data through the Avalon streaming interface on its FPGA fabric interface.

Figure 1. Typical Application Using Simplex Core

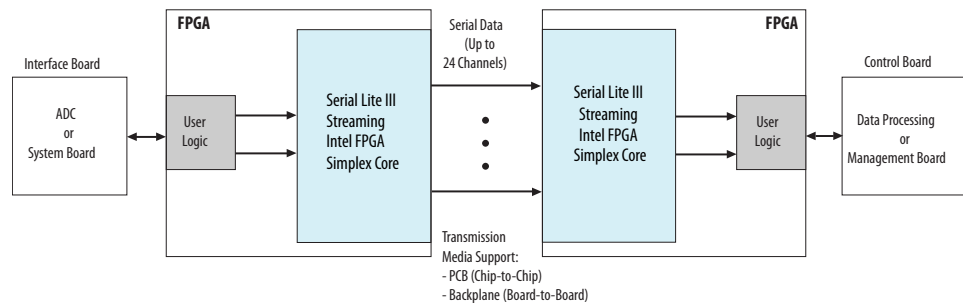
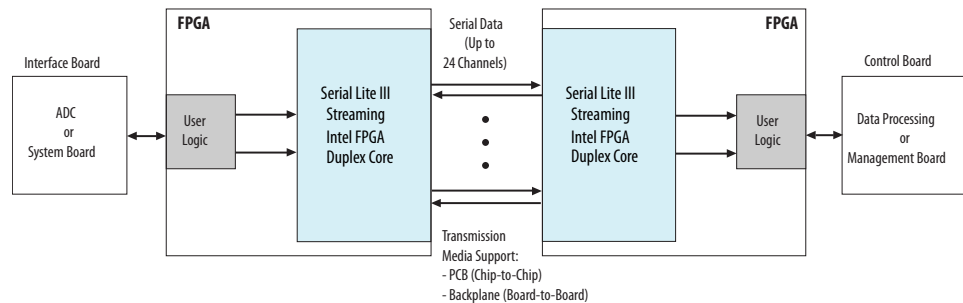
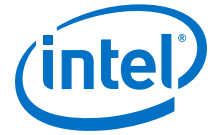

Figure 2. Typical System Application Using Duplex Core



2.1. Serial Lite III Streaming IP Core Protocol

The Serial Lite III Streaming IP core implements a protocol that supports high bandwidth data streaming over a unidirectional or bidirectional, high-speed serial link.



The Serial Lite III Streaming IP core has the following protocol features:

- Simplex source only, simplex sink only, and duplex (transmitter and receiver) operations
- Support for single or multiple lanes
- 64B/67B physical layer encoding
- Payload and idle scrambling
- Error detection:
 - Source burst gap mismatch error
 - Error Correction Code (ECC) with 1 bit correction and 2 or more bits detection
 - Sink and source adaptation First In First Out (FIFO) overflow error
 - Sink Cyclic Redundancy Check (CRC) errors
 - Sink Physical Coding Sublayer (PCS) synchronization, metaframe, or CRC errors
- Low protocol overhead
- Low point-to-point transfer latency
- Reduces soft logic resource utilization using hardened Transceiver Native PHY Intel Arria 10 FPGA IP core and L-Tile/H-Tile/E-Tile Transceiver Intel Stratix 10 FPGA IP Core or Interlaken PHY v18.1 IP core (Stratix V and Arria V GZ devices)

2.2. Serial Lite III Streaming IP Core Protocol Operating Modes

The protocol defines two operating modes for different applications: continuous and burst mode.

The IP core that you generate can be in either mode. No parameter option is available to select between continuous and burst modes. The selection depends on how you provide data at the Avalon streaming TX interface.

2.2.1. Continuous Mode

The Serial Lite III Streaming link operating in continuous mode accepts and transmits user data over the link, and presents it at the user interface at the receiving link at the same rate and without gaps in the stream, if user logic does not de-assert data valid signal as part of the stream. However, the streaming interface stops operating in continuous mode if user logic de-asserts the data valid signal in the middle of data transfer and there is no guarantee that the end-point sink is able to replicate the exact data pattern of the source. When operating in this mode, a link implementing the protocol looks like a data pipe that can transparently forward all data presented on the user interface to the far end of the link.

Continuous mode is appropriate for applications that require a simple interface to transmit a single, high bandwidth data stream. An example of this application is sensor data links for radar and wireless infrastructure. With this mode, data converters can connect to either end of the link with minimal interface logic.

Important: Continuous mode is applicable only in Standard Clocking Mode., It is not possible to operate in this mode with asynchronous clocking implementation because asynchronous clocking requires data valid signal to be de-asserted, to break the data stream to avoid FIFO overflow at the sink due to PPM difference.

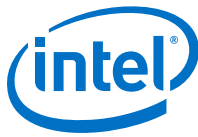

2.2.2. Burst Mode

The Serial Lite III Streaming IP core link operating in burst mode accepts bursts of data across the user interface and transmits each burst across the link as a discrete data burst.

Burst mode is appropriate for applications where the data stream is divided into bursts of data. An example of this application is uncompressed digital video where the data stream is divided into lines of display raster. This mode provides more flexibility to the clocking and also supports multiplexing of multiple data streams across the link.

Important: The minimum required gap between bursts is 1 user clock cycle on the transmit side. Therefore, you must provide one extra user clock cycle between an end of burst and the start of the next burst. The Serial Lite III Streaming IP core allows you to select between 1 or 2 burst gap. To connect the IP core of version 15.1 to IP core of the previous version, you must select a burst gap of 2 for backward compatibility.

Related Information

- [Standard Clocking Mode](#) on page 75
- [Advanced Clocking Mode](#) on page 82

2.3. Performance and Resource Utilization

Serial Lite III Streaming Intel FPGA IP in Intel Stratix 10 devices support the following transceiver tiles for each device speed grade and data rate:

Table 2. Serial Lite III Streaming Intel FPGA IP Transceiver Tiles Support in Intel Stratix 10 Devices

Data Rate	Core Speed Grade	Maximum Supported Lanes		
		L-Tile Transceiver	H-Tile Transceiver	E-Tile Transceiver
17.4 Gbps	1	24	24	24
	2	22	24	24
	3	18	20	24
25.0 Gbps	1	6	8	12
	2	4	6	8
28.0 Gbps	1	N/A	4	4
	2	N/A	2	1

Table 3. Serial Lite III Streaming IP Performance and Resource Utilization with L-Tile Transceiver in Intel Stratix 10 Devices

These typical resources and expected performance for different Serial Lite III Streaming IP core variants are obtained using the Intel Quartus Prime Pro Edition software targeting the Intel Stratix 10 1SG280LU3F50E1VG device for 17.4 Gbps data rate and 1SG280LU2F50E1VG device for 25 Gbps data rate. The resource utilization numbers are the same for ECC enabled and disabled.

Direction	Clocking Mode	Data Lanes	Per-Lane Data Rate (Mbps)	ALMs	Primary	Secondary	M20K
Source	Standard	24	17400	11675	13622	776	49
	Standard	6	25000	3160	3644	215	13

continued...

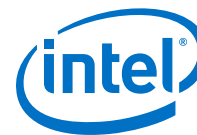

Direction	Clocking Mode	Data Lanes	Per-Lane Data Rate (Mbps)	ALMs	Primary	Secondary	M20K
	Advance	24	17400	11691	13571	919	49
	Advance	6	25000	3139	3687	181	13
Sink	Standard	24	17400	5181	7532	2065	49
	Standard	6	25000	1463	2009	513	13
	Advance	24	17400	4485	6994	2359	0
	Advance	6	25000	1245	1792	629	0
Duplex	Standard	24	17400	15793	19074	2913	98
	Standard	6	25000	4299	5123	698	26
	Advance	24	17400	14984	18880	2976	49
	Advance	6	25000	4025	4980	812	13

Table 4. Serial Lite III Streaming IP Performance and Resource Utilization with H-Tile Transceiver in Intel Stratix 10 Devices

These typical resources and expected performance for different Serial Lite III Streaming IP core variants are obtained using the Intel Quartus Prime Pro Edition software targeting the Intel Stratix 10 1SG280HU3F50E1VG device for 17.4 Gbps data rate, 1SG280HU2F50E1VG device for 25 Gbps data rate, and 1SG280HU1F50E1VG device for 28 Gbps data rate. The resource utilization numbers are the same for ECC enabled and disabled.

Direction	Clocking Mode	Data Lanes	Per-Lane Data Rate (Mbps)	ALMs	Primary	Secondary	M20K
Source	Standard	24	17400	11708	13604	851	49
	Standard	8	25000	5013	5048	296	17
	Standard	4	28000	2652	2803	193	9
	Advance	24	17400	11638	13636	817	49
	Advance	8	25000	4919	5195	324	17
	Advance	4	28000	2649	2830	176	9
Sink	Standard	24	17400	5175	7732	1907	49
	Standard	8	25000	2685	3063	666	17
	Standard	4	28000	1367	1659	263	9
	Advance	24	17400	4524	7045	2295	0
	Advance	8	25000	2530	3009	761	0
	Advance	4	28000	1371	1599	397	0
Duplex	Standard	24	17400	15790	19353	2814	98
	Standard	8	25000	6239	7332	949	34
	Standard	4	28000	3391	3916	526	18
	Advance	24	17400	15012	18941	3078	49
	Advance	8	25000	6208	7174	987	17
	Advance	4	28000	3312	3824	533	9



Table 5. Serial Lite III Streaming IP Performance and Resource Utilization with E-Tile Transceiver in Intel Stratix 10 Devices

These typical resources and expected performance for different Serial Lite III Streaming IP core variants are obtained using the Intel Quartus Prime Pro Edition software targeting the Intel Stratix 10 1ST280EY3F55E1VG device for 17.4 Gbps data rate, 1ST280EY2F55E1VG device for 25 Gbps data rate, and 1ST280EY1F55E1VG device for 28 Gbps data rate. The resource utilization numbers are the same for ECC enabled and disabled.

Direction	Clocking Mode	Data Lanes	Per-Lane Data Rate (Mbps)	ALMs	Primary	Secondary	M20K
Duplex	Standard	24	17400	48277	59072	10903	194
	Standard	12	25000	24026	28845	5717	73
	Standard	4	28000	8596	9825	1904	34
	Advance	24	17400	47516	58816	11321	145
	Advance	12	25000	24460	28608	5265	98
	Advance	4	28000	8377	9559	1823	25

Table 6. Serial Lite III Streaming IP Performance and Resource Utilization for Intel Arria 10 Devices

These typical resources and expected performance for different Serial Lite III Streaming IP core variants are obtained using the Intel Quartus Prime Pro Edition software targeting the Intel Arria 10 (10AX115S1F45I1SGES) FPGA devices.

Direction	Clocking Mode	Maximum Supported Data Lanes	Per-Lane Data Rate (Mbps)	ECC	ALMs	Primary	Secondary	M20K
Source	Standard	24	17400 ⁽²⁾	Disabled	2613	5049	780	39
	Standard	24	17400 ⁽²⁾	Enabled	5961	9680	525	72
	Advanced	24	17400 ⁽²⁾	Disabled	3009	5240	570	39
	Advanced	24	17400 ⁽²⁾	Enabled	6065	9659	552	72
Sink	Standard	24	17400 ⁽²⁾	Disabled	3974	7550	1750	49
	Standard	24	17400 ⁽²⁾	Enabled	4065	7570	1632	50
	Advanced	24	17400 ⁽²⁾	Disabled	3297	5815	1580	0
	Advanced	24	17400 ⁽²⁾	Enabled	3275	5524	1870	0
Duplex	Standard	24	17400 ⁽²⁾	Disabled	6152	12511	2000	88
	Standard	24	17400 ⁽²⁾	Enabled	9313	16606	2193	122
	Advanced	24	17400 ⁽²⁾	Disabled	5833	10462	2146	39
	Advanced	24	17400 ⁽²⁾	Enabled	8868	14853	2112	72

⁽²⁾ Available only with transceiver speed grade 1.

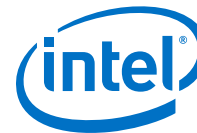

Table 7. Serial Lite III Streaming IP Performance and Resource Utilization for Stratix V and Arria V Devices

These typical resources and expected performance for different Serial Lite III Streaming IP core variants are obtained using the Intel Quartus Prime Standard Edition software targeting the Stratix V GX (5SGXMA7H2F35C2) and the Arria V GZ (5AGZME7K2F40I3L) FPGA devices.

Direction	Clocking Mode	Maximum Supported Data Lanes	Per-Lane Data Rate (Mbps)	ECC	ALMs	Primary	Secondary	M20K
Source	Standard	24	10312.50	Disabled	5684	6114	46	39
	Standard	24	10312.50	Enabled	11122	13422	271	72
	Advanced	24	10312.50	Disabled	5680	6104	43	39
	Advanced	24	10312.50	Enabled	11015	13418	239	72
Sink	Standard	24	10312.50	Disabled	5499	9601	93	49
	Standard	24	10312.50	Enabled	5517	9510	91	50
	Advanced	24	10312.50	Disabled	4356	7757	43	0
	Advanced	24	10312.50	Enabled	4356	7757	43	0
Duplex	Standard	24	10312.50	Disabled	8742	15024	165	88
	Standard	24	10312.50	Enabled	14045	22279	337	122
	Advanced	24	10312.50	Disabled	7550	13211	74	39
	Advanced	24	10312.50	Enabled	12606	20534	293	72

3. Getting Started

Related Information

- [Introduction to Intel IP Cores](#)
Provides general information about all Intel FPGA IP cores, including parameterizing, generating, upgrading, and simulating IP cores.
- [Creating Version-Independent IP and Qsys Simulation Scripts](#)
Create simulation scripts that do not require manual updates for software or IP version upgrades.
- [Project Management Best Practices](#)
Guidelines for efficient management and portability of your project and IP files.

3.1. Installing and Licensing Intel FPGA IP Cores

The Intel Quartus Prime software installation includes the Intel FPGA IP library. This library provides many useful IP cores for your production use without the need for an additional license. Some Intel FPGA IP cores require purchase of a separate license for production use. The Intel FPGA IP Evaluation Mode allows you to evaluate these licensed Intel FPGA IP cores in simulation and hardware, before deciding to purchase a full production IP core license. You only need to purchase a full production license for licensed Intel IP cores after you complete hardware testing and are ready to use the IP in production.

The Intel Quartus Prime software installs IP cores in the following locations by default:

Figure 3. IP Core Installation Path

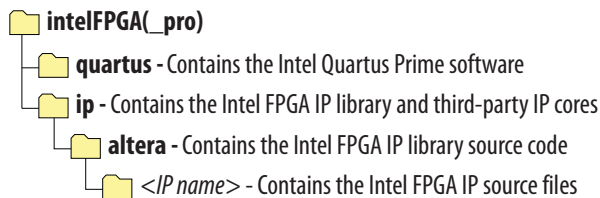
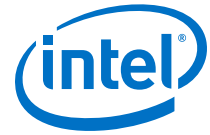

Table 8. IP Core Installation Locations

Location	Software	Platform
<drive>:\intelFPGA_pro\quartus\ip\altera	Intel Quartus Prime Pro Edition	Windows*
<drive>:\intelFPGA\quartus\ip\altera	Intel Quartus Prime Standard Edition	Windows
<home directory>:/intelFPGA_pro/quartus/ip/altera	Intel Quartus Prime Pro Edition	Linux*
<home directory>:/intelFPGA/quartus/ip/altera	Intel Quartus Prime Standard Edition	Linux

Intel Corporation. All rights reserved. Agilix, Altera, Arria, Cyclone, Enpirion, Intel, the Intel logo, MAX, Nios, Quartus and Stratix words and logos are trademarks of Intel Corporation or its subsidiaries in the U.S. and/or other countries. Intel warrants performance of its FPGA and semiconductor products to current specifications in accordance with Intel's standard warranty, but reserves the right to make changes to any products and services at any time without notice. Intel assumes no responsibility or liability arising out of the application or use of any information, product, or service described herein except as expressly agreed to in writing by Intel. Intel customers are advised to obtain the latest version of device specifications before relying on any published information and before placing orders for products or services.

*Other names and brands may be claimed as the property of others.



Note: The Intel Quartus Prime software does not support spaces in the installation path.

3.2. Intel FPGA IP Evaluation Mode

The free Intel FPGA IP Evaluation Mode allows you to evaluate licensed Intel FPGA IP cores in simulation and hardware before purchase. Intel FPGA IP Evaluation Mode supports the following evaluations without additional license:

- Simulate the behavior of a licensed Intel FPGA IP core in your system.
- Verify the functionality, size, and speed of the IP core quickly and easily.
- Generate time-limited device programming files for designs that include IP cores.
- Program a device with your IP core and verify your design in hardware.

Intel FPGA IP Evaluation Mode supports the following operation modes:

- **Tethered**—Allows running the design containing the licensed Intel FPGA IP indefinitely with a connection between your board and the host computer. Tethered mode requires a serial joint test action group (JTAG) cable connected between the JTAG port on your board and the host computer, which is running the Intel Quartus Prime Programmer for the duration of the hardware evaluation period. The Programmer only requires a minimum installation of the Intel Quartus Prime software, and requires no Intel Quartus Prime license. The host computer controls the evaluation time by sending a periodic signal to the device via the JTAG port. If all licensed IP cores in the design support tethered mode, the evaluation time runs until any IP core evaluation expires. If all of the IP cores support unlimited evaluation time, the device does not time-out.
- **Untethered**—Allows running the design containing the licensed IP for a limited time. The IP core reverts to untethered mode if the device disconnects from the host computer running the Intel Quartus Prime software. The IP core also reverts to untethered mode if any other licensed IP core in the design does not support tethered mode.

When the evaluation time expires for any licensed Intel FPGA IP in the design, the design stops functioning. All IP cores that use the Intel FPGA IP Evaluation Mode time out simultaneously when any IP core in the design times out. When the evaluation time expires, you must reprogram the FPGA device before continuing hardware verification. To extend use of the IP core for production, purchase a full production license for the IP core.

You must purchase the license and generate a full production license key before you can generate an unrestricted device programming file. During Intel FPGA IP Evaluation Mode, the Compiler only generates a time-limited device programming file (`<project name>_time_limited.sof`) that expires at the time limit.

Figure 4. Intel FPGA IP Evaluation Mode Flow

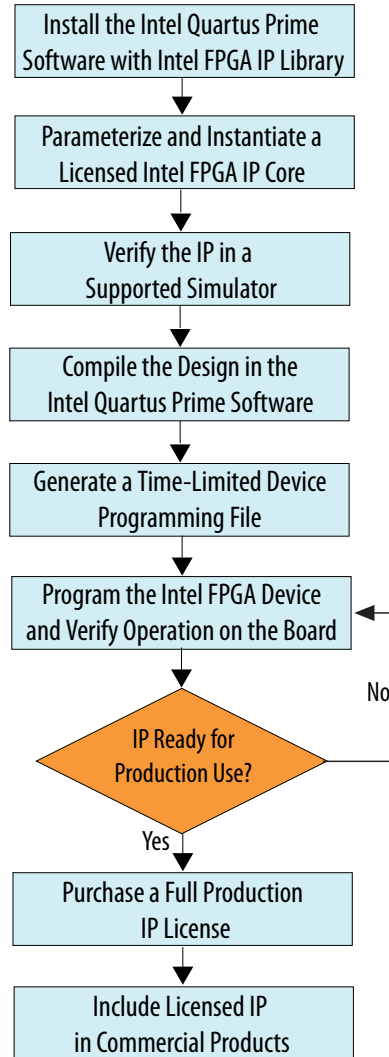

Note: Refer to each IP core's user guide for parameterization steps and implementation details.

Intel licenses IP cores on a per-seat, perpetual basis. The license fee includes first-year maintenance and support. You must renew the maintenance contract to receive updates, bug fixes, and technical support beyond the first year. You must purchase a full production license for Intel FPGA IP cores that require a production license, before generating programming files that you may use for an unlimited time. During Intel FPGA IP Evaluation Mode, the Compiler only generates a time-limited device programming file (*<project name>_time_limited.sof*) that expires at the time limit. To obtain your production license keys, visit the [Self-Service Licensing Center](#).

The [Intel FPGA Software License Agreements](#) govern the installation and use of licensed IP cores, the Intel Quartus Prime design software, and all unlicensed IP cores.

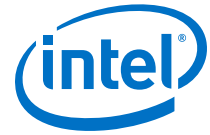

Related Information

- [Intel Quartus Prime Licensing Site](#)
- [Introduction to Intel FPGA Software Installation and Licensing](#)

3.2.1. Intel FPGA IP Evaluation Mode Timeout Behavior

All IP cores in a device time out simultaneously when the most restrictive evaluation time is reached. If there is more than one IP core in a design, the time-out behavior of the other IP cores may mask the time-out behavior of a specific IP core .

For IP cores, the untethered time-out is one hour; the tethered time-out value is indefinite. Your design stops working after the hardware evaluation time expires. The Intel Quartus Prime software uses Intel FPGA IP Evaluation Mode Files (.ocp) in your project directory to identify your use of the Intel FPGA IP Evaluation Mode evaluation program. After you activate the feature, do not delete these files.

When the evaluation time expires, the `link_up` signal goes low.

Related Information

[AN 320: Using Intel FPGA IP Evaluation Mode](#)

3.3. Specifying IP Core Parameters and Options

Follow these steps to specify IP core parameters and options.

1. In the Platform Designer IP Catalog (**Tools > IP Catalog**), locate and double-click the name of the IP core to customize. The parameter editor appears.
2. Specify a top-level name for your custom IP variation. This name identifies the IP core variation files in your project. If prompted, also specify the target FPGA device family and output file HDL preference. Click **OK**.
3. Specify parameters and options for your IP variation:
 - Optionally select preset parameter values. Presets specify all initial parameter values for specific applications (where provided).
 - Specify parameters defining the IP core functionality, port configurations, and device-specific features.
 - Specify options for generation of a timing netlist, simulation model, testbench, or example design (where applicable).
 - Specify options for processing the IP core files in other EDA tools.
4. Click **Finish** to generate synthesis and other optional files matching your IP variation specifications. The parameter editor generates the top-level .qsys IP variation file and HDL files for synthesis and simulation. Some IP cores also simultaneously generate a testbench or example design for hardware testing.

The top-level IP variation is added to the current Intel Quartus Prime project. Click **Project > Add/Remove Files in Project** to manually add a .qsys (Intel Quartus Prime Standard Edition) or .ip (Intel Quartus Prime Pro Edition) file to a project. Make appropriate pin assignments to connect ports.

3.3.1. Serial Lite III Streaming IP Core Parameter Editor

Based on the values you set, the Serial Lite III Streaming IP core parameter editor automatically calculates the rest of the parameters, and provides you with the following values or information:

- Input data rate per lane
- Transceiver data rate per lane
- A list of feasible transceiver reference clock frequencies, one of which you select to provide to the core

Important: If your design targets Stratix V or Arria V GZ devices, you cannot migrate your design to Intel Arria 10 and Intel Stratix 10 devices automatically. For Intel Arria 10 devices, the transceiver reconfiguration functionality is embedded inside the transceivers. Therefore, you must re-instantiate the IP core to target Intel Arria 10 devices. For Intel Stratix 10 devices, you must re-instantiate the IP core to target specific transceiver tiles due to the transceiver architecture differences. You cannot migrate your design from Intel Stratix 10 L-tile/H-Tile devices to Intel Stratix 10 E-Tile devices.

Related Information

[Parameter Settings for Intel Stratix 10 Devices](#) on page 17

3.3.2. Intel Arria 10 Designs

If your design targets the Intel Arria 10 devices:

- The parameter editor displays a message about the required output clock frequency of the external TX PLL IP clock. For source or duplex modes, connect the Transceiver PHY Reset Controller to the TX PLL to ensure the appropriate HSSI power-up sequence.
- For source only Intel Arria 10 implementations, the parameter editor does not provide the transceiver reference clock frequency because the user is expected to provide the transmit serial clock. If you use an on-chip PLL to generate the transmit serial clock, you can use the same PLL reference clock frequency that you provide to the core in the sink direction, operating at the same user clock frequency (or equivalent transceiver lane data rate).
- The Serial Lite III Streaming Intel Arria 10 FPGA IP core expects the user to provide the transmitter's serial clock. If you compile the IP without the proper serial clock, the Intel Quartus Prime Compiler issues a compilation error.
- When generating the example testbench, the Serial Lite III Streaming Intel Arria 10 FPGA IP core instantiates an external transceiver ATX PLL for the transmit serial clock based on the required user clock only when configured in sink or duplex mode. The transceiver ATX PLL core is configured with the transceiver reference clock specified in the parameter editor and transmit serial clock.
- To generate the Serial Lite III Streaming Intel Arria 10 FPGA IP Core example testbench using the parameter editor, select **Generate Example Designs > <directory_name>**. Intel recommends that you generate the Intel Arria 10 simulation testbench for the sink or duplex direction.

Related Information

- [Parameter Settings for Intel Arria 10 Devices](#) on page 19
- [Intel Stratix 10, Intel Arria 10, Stratix V, and Arria V GZ Variations](#) on page 38



- Intel Arria 10 SerialLite III Streaming IP Core Design Example User Guide

3.4. Serial Lite III Streaming IP Core Parameters

3.4.1. Parameter Settings for Intel Stratix 10 Devices

Table 9. IP

Parameter	Value	Default	Description
General Design Options			
Direction	Source, Sink, Duplex	Duplex	Select the variation of the IP core. Supports source, sink, or full duplex transmissions. <i>Note:</i> Sink or source only variant is not supported when you select E-Tile as the transceiver tile in Intel Quartus Prime Pro Edition v18.1.
Number of lanes	1-24	6	Specifies the number of lanes (equal to physical transceiver links) that are used to transfer the streaming data.
Meta frame length in words	200-8191	200	Specifies the metaframe length.
Transceiver reference clock frequency	<Range supported by the transceiver PLLs>	312.5 MHz	Supports multiple transceiver reference clock frequencies for flexibility in the oscillator and PLL choices. This transceiver reference clock frequency must match the external PLL reference clock frequency for Intel Stratix 10 L-tile/H-tile devices.. <i>Note:</i> Transceiver reference clock is limited to 500 MHz when you select E-Tile as the transceiver tile in Intel Quartus Prime Pro Edition v18.1.
VCCR_GXB and VCCT_GXB supply voltage for the Transceiver	1_1V, 1_0V	1_0V	Select VCCR_GXB and VCCT_GXB supply voltages. Refer to <i>Intel Stratix 10 Device Family Pin Connection Guidelines</i> for more information related to these pins. <i>Note:</i> This parameter is not available when you select E-Tile as the transceiver tile.
Transceiver channel type	GX, GXT	GX	Select the transceiver channel variant. Select GXT as the transceiver variant to implement data rate more than 17.4 Gbps. <i>Note:</i> This parameter is not available when you select E-Tile as the transceiver tile.
Enable M20K ECC support	Yes/No	No	Select to use error correcting code (ECC) protection to strengthen the FIFO buffers from single-event upset (SEU) changes. Enables built-in error correcting code (ECC) support on the M20K embedded block memory for single-error correction, double-adjacent-error correction, and triple-adjacent-error detection.
Transceiver Tile	L-Tile, H-Tile, E-Tile	<Depending on the transceiver tile supported in the chosen device. For Intel Stratix 10 devices which support H-Tile and E-Tile, the default value is H-Tile.>	Reports the actual transceiver tile. The value changes according to the transceiver crete tile chosen in the device.
User Interface			
<i>continued...</i>			



Parameter	Value	Default	Description
Streaming Mode	Basic, Full	Full	Specifies the streaming mode. <ul style="list-style-type: none"> Basic: This is a pure streaming mode where data is sent without burst, sync, empty cycle, and frame delimiter to increase bandwidth. Full: This mode sends a burst and sync cycle at the start of frame and a burst and empty cycle at the end of frame. Provide a gap of one empty cycle between two data frames.
Required idle cycles between bursts	1, 2	2	Supports two values to optimize for bandwidth efficiency or maintain backward compatibility with existing Serial Lite III Streaming IP cores (legacy). <ul style="list-style-type: none"> 1: Recommended for high bandwidth streaming. The same Burst Gap setting must be set for both source and sink IP core. 2: For backward compatibility with Quartus II version 15.1 and older sink IP core.
Adaptation FIFO partial full threshold	8 - 18	15	Specifies the partial full threshold of the transmit FIFO. ready_tx signal will de-assert when data reaches this level in the FIFO.
Clocking mode	Standard clocking mode, Advanced clocking mode	Standard clocking mode	Specifies the clocking mode. Refer to Serial Lite III Streaming IP Core Clocking Guidelines on page 75 for more information.
User input	User clock frequency, Transceiver data rate	User clock frequency	Select User clock frequency to specify the user clock input and allow the IP core to determine the transceiver data rate. Select Transceiver data rate to specify the desired data rate and allow the IP core to determine the user clock frequency.
User clock frequency required	Minimum: 50 MHz Maximum: Limited by the supported transceiver data rates	177.556818 MHz	Specifies the desired frequency for the user clock input for the transmit (Standard Clocking Mode and Advanced Clocking Mode) and receive user interface (Standard Clocking Mode). This frequency in turn determines the required transceiver data rate to support the calculated transmit and receive bandwidths.
Transceiver data rate	required user clock frequency * overheads * 64	12.5 Gbps	The effective data rate at the output of the transceivers, incorporating transmission and other overheads. The parameter editor automatically calculates this value by adding the input data rate with transmission overheads to provide you with a selection of user clock frequency.
Aggregate user bandwidth	number of lanes * required user clock frequency * 64	68.18 Gbps	This value is derived by multiplying the number of lanes and user interface data rate.

IP Debug and Phy Dynamic Reconfiguration

Table 10. Native Transceiver Phy

Parameter	Value	Default	Description
Dynamic Reconfiguration			
Enable dynamic reconfiguration	On	On	Enables the dynamic reconfiguration interface. <i>Note:</i> This parameter is enabled by default and can not be disabled.
<i>continued...</i>			

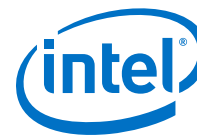

Parameter	Value	Default	Description
Enable Altera Debug Master Endpoint	On/Off	Off	Enables ADME and Optional Reconfiguration Logic parameters of the L-Tile/H-Tile/E-Tile Transceiver Native PHY Intel Stratix 10 FPGA IP Core.
Optional Reconfiguration Logic			
Enable capability registers	On/Off	Off	Enables capability registers that provide high level information about the configuration of the transceiver channel.
Set user-defined IP identifier	User-defined	0	Sets a user-defined numeric identifier that can be read from the <code>user_identifier</code> offset when the capability registers are enabled. <i>Note:</i> To set the value, enable the Enable capability registers parameter.
Enable control and status registers	On/Off	Off	Enables soft registers to read status signals and write control signals on the PHY interface through the embedded debug.
Enable PRBS (Pseudo Random Binary Sequence) soft accumulators	On/Off	Off	Enables soft logic for performing PRBS bit and error accumulation when the hard PRBS generator and checker are used. <i>Note:</i> This parameter is not available when you select E-Tile as the transceiver tile.

For information about parameters in the **PMA Adaptation** tab, please refer to the *PMA Adaptation* topic in the *Intel Stratix 10 E-Tile Transceiver PHY User Guide*.

Note: The **PMA Adaptation** tab is only available in Intel Stratix 10 with E-tile transceiver devices. You must select **E-Tile** as the **Transceiver Tile** to use the parameters in the **PMA Adaptation** tab.

Related Information

- [Serial Lite III Streaming IP Core Parameter Editor](#) on page 16
- [Intel Stratix 10 L- and H-Tile Transceiver PHY User Guide - Dynamic Reconfiguration Parameters](#)
- [Intel Stratix 10 E-Tile Transceiver PHY User Guide](#)
For more information about the Intel Stratix 10 E-Tile Native PHY IP core.
- [Intel Stratix 10 E-Tile Transceiver PHY User Guide](#)
For more information about PMA Adaptation parameters.

3.4.2. Parameter Settings for Intel Arria 10 Devices

Table 11. IP

Parameter	Value	Default	Description
General Design Options			
Direction	Source, Sink, Duplex	Duplex	Supports source, sink, or full duplex transmissions.
Number of lanes	1-24	2	Specifies the number of lanes (equal to physical transceiver links) that are used to transfer the streaming data.
<i>continued...</i>			

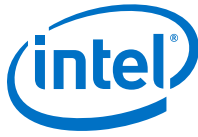

Parameter	Value	Default	Description
Transceiver reference clock frequency	<Range supported by the transceiver PLLs>	644.53125 MHz	Supports multiple transceiver reference clock frequencies for flexibility in the oscillator and PLL choices. This transceiver reference clock frequency must match the external PLL reference clock frequency.
Meta frame length in words	200–8191	200	Specifies the metaframe length.
Enable Transceiver Native PHY ADME	On/Off	Off	Turn on to enable ADME and Optional Reconfiguration Logic parameters of the Transceiver Native PHY Intel Arria 10/Intel Cyclone® 10 GX FPGA IP core.
Enable M20K ECC support	On/Off	Off	Turn on to use error correcting code (ECC) protection to strengthen the FIFO buffers from single-event upset (SEU) changes. Enables built-in error correcting code (ECC) support on the M20K embedded block memory for single-error correction, double-adjacent-error correction, and triple-adjacent-error detection.
User Interface			
Required idle cycles between bursts	1, 2	2	Supports two values to optimize for bandwidth efficiency or maintain backward compatibility with existing Serial Lite III Streaming IP cores (legacy). <ul style="list-style-type: none"> 1: Recommended for high bandwidth streaming. The same Burst Gap setting must be set for both source and sink IP core. 2: For backward compatibility with Quartus II version 15.1 and older sink IP core.
Clocking mode	Standard clocking mode, Advanced clocking mode	Standard clocking mode	Specifies the clocking mode. Refer to Serial Lite III Streaming IP Core Clocking Guidelines on page 75 for more information.
User input	User clock frequency, Transceiver data rate	User clock frequency	Select User clock frequency to specify the user clock input and allow the IP core to determine the transceiver data rate. Select Transceiver data rate to specify the desired data rate and allow the IP core to determine the user clock frequency.
User clock frequency required	Minimum: 50 MHz Maximum: Limited by the supported transceiver data rates	150 MHz	Specifies the desired frequency for the user clock input for the transmit (Standard Clocking Mode and Advanced Clocking Mode) and receive user interface (Standard Clocking Mode). This frequency in turn determines the required transceiver data rate to support the calculated transmit and receive bandwidths.
User clock frequency output	Minimum: 50 MHz Maximum: Limited by the supported transceiver data rates	150 MHz	Specifies the actual user clock frequency as produced by the fPLL or I/O PLL and is ideally the same as the required clock frequency. In certain very high precision situations where the desired user clock is provided up to higher decimal places, this value can vary slightly due to the fPLL or I/O PLL constraints. Change the required clock frequency to correct the issue if the minute variation is intolerable.
Transceiver data rate	required user clock frequency * overheads * 64	10.312499 Gbps	The effective data rate at the output of the transceivers, incorporating transmission and other overheads. The parameter editor automatically calculates this value by adding the input data rate with transmission overheads to provide you with a selection of user clock frequency.
Aggregate user bandwidth	number of lanes * required user clock frequency * 64	18.75 Gbps	This value is derived by multiplying the number of lanes and user interface data rate.

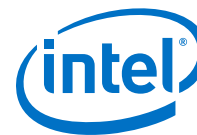

3.4.3. Parameter Settings for Stratix V and Arria V GZ Devices

Table 12. IP

Parameter	Value	Default	Description
General Design Options			
Direction	Source, Sink, Duplex	Duplex	Supports source, sink, or full duplex transmissions.
Number of lanes	1–24	2	Specifies the number of lanes (equal to physical transceiver links) that are used to transfer the streaming data.
Device speed grade	1–4	2	Specifies the device speed grade.
PLL type	ATX, CMU	CMU	Selects the transceiver PLL type.
Transceiver reference clock frequency	<Range supported by the transceiver PLLs>	644.53125 MHz	Supports multiple transceiver reference clock frequencies for flexibility in the oscillator and PLL choices. This transceiver reference clock frequency must match the external PLL reference clock frequency.
Meta frame length in words	200–8191	200	Specifies the metaframe length.
Enable M20K ECC support	On/Off	Off	Turn on to use error correcting code (ECC) protection to strengthen the FIFO buffers from single-event upset (SEU) changes. Enables built-in error correcting code (ECC) support on the M20K embedded block memory for single-error correction, double-adjacent-error correction, and triple-adjacent-error detection.
User Interface			
Required idle cycles between bursts	1, 2	2	Supports two values to optimize for bandwidth efficiency or maintain backward compatibility with existing Serial Lite III Streaming IP cores (legacy). <ul style="list-style-type: none"> 1: Recommended for high bandwidth streaming. The same Burst Gap setting must be set for both source and sink IP core. 2: For backward compatibility with Quartus II version 15.1 and older sink IP core.
Clocking mode	Standard clocking mode, Advanced clocking mode	Standard clocking mode	Specifies the clocking mode. Refer to Serial Lite III Streaming IP Core Clocking Guidelines on page 75 for more information.
User input	User clock frequency, Transceiver data rate	User clock frequency	Select User clock frequency to specify the user clock input and allow the IP core to determine the transceiver data rate. Select Transceiver data rate to specify the desired data rate and allow the IP core to determine the user clock frequency.
User clock frequency required	Minimum: 50 MHz Maximum: Limited by the supported transceiver data rates	146.484375 MHz	Specifies the desired frequency for the user clock input for the transmit (Standard Clocking Mode and Advanced Clocking Mode) and receive user interface (Standard Clocking Mode). This frequency in turn determines the required transceiver data rate to support the calculated transmit and receive bandwidths.
User clock frequency output	Minimum: 50 MHz Maximum: Limited by the supported transceiver data rates	146.484375 MHz	Specifies the actual user clock frequency as produced by the fPLL or I/O PLL and is ideally the same as the required clock frequency. In certain very high precision situations where the desired user clock is provided up to higher decimal places, this value can vary slightly due to the fPLL
<i>continued...</i>			



Parameter	Value	Default	Description
			or I/O PLL constraints. Change the required clock frequency to correct the issue if the minute variation is intolerable.
Transceiver data rate	Required user clock frequency * overheads * 64	10.3125 Gbps	The effective data rate at the output of the transceivers, incorporating transmission and other overheads. The parameter editor automatically calculates this value by adding the input data rate with transmission overheads to provide you with a selection of user clock frequency.
Aggregate user bandwidth	Number of lanes * required user clock frequency * 64	18.3125 Gbps	This value is derived by multiplying the number of lanes and user interface data rate.

3.5. Transceiver Reconfiguration Controller for Stratix V and Arria V GZ Designs

If your design targets Stratix V or Arria V GZ devices, the transceiver reconfiguration controller is not included in the generated IP core. To create a complete system, refer to the design example block diagram on how to connect the transceiver reconfiguration controller.

Note: If your design targets Intel Arria 10 and Intel Stratix 10 devices, the transceiver reconfiguration functionality is embedded inside the transceivers. The `phy_mgmt` bus interface connects directly to the Avalon memory-mapped dynamic reconfiguration interface of the embedded Intel Arria 10 and Intel Stratix 10 Native PHY IP core. This interface is provided at the top level. For Quartus compilation design, create clock constraints for the `phy_mgmt_clk` and `reconfig_to_xcvr[0]` (for Stratix V and Arria V GZ) signals to avoid unconstrained clock warnings.

Related Information

[V-Series Transceiver PHY IP Core User Guide](#)

For more information about Reconfiguration Controller in the Interlaken PHY IP Core.

3.6. IP Core Generation Output (Intel Quartus Prime Pro Edition)

The Intel Quartus Prime software generates the following output file structure for individual IP cores that are not part of a Platform Designer system.

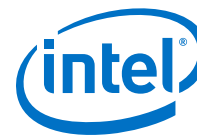

Figure 5. Individual IP Core Generation Output (Intel Quartus Prime Pro Edition)

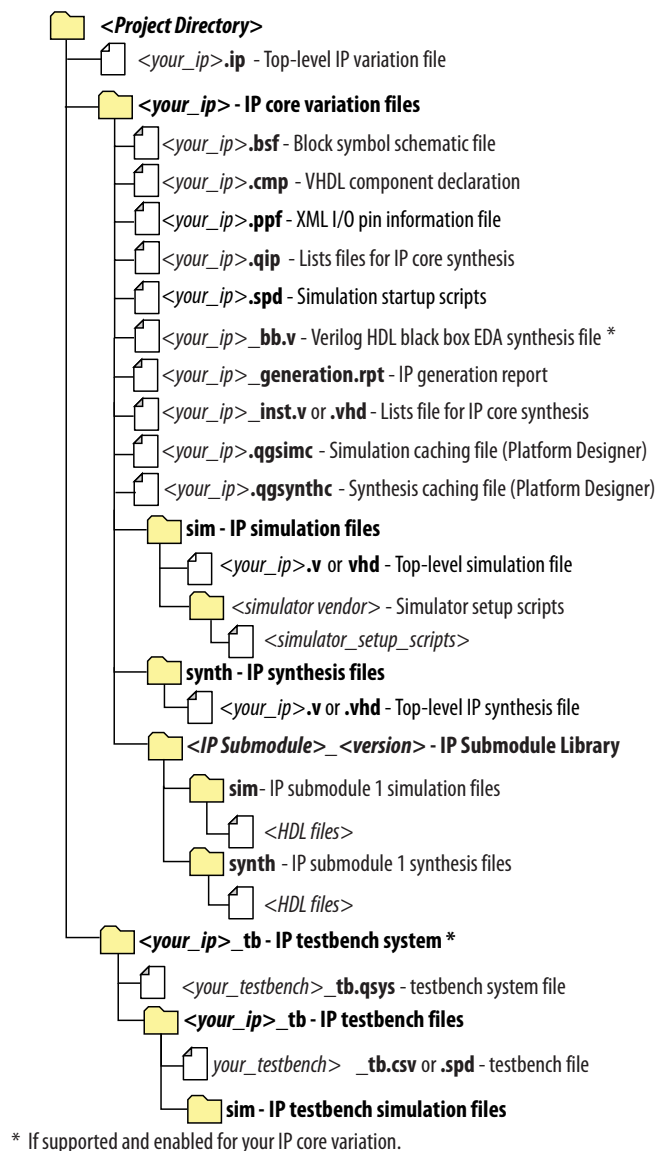
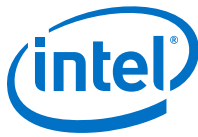

Table 13. Output Files of Intel FPGA IP Generation

File Name	Description
<your_ip>.ip	Top-level IP variation file that contains the parameterization of an IP core in your project. If the IP variation is part of a Platform Designer system, the parameter editor also generates a .qsys file.
<your_ip>.cmp	The VHDL Component Declaration (.cmp) file is a text file that contains local generic and port definitions that you use in VHDL design files.
<your_ip>_generation.rpt	IP or Platform Designer generation log file. Displays a summary of the messages during IP generation.

continued...



File Name	Description
<your_ip>.qgsimc (Platform Designer systems only)	Simulation caching file that compares the .qsys and .ip files with the current parameterization of the Platform Designer system and IP core. This comparison determines if Platform Designer can skip regeneration of the HDL.
<your_ip>.qgsynth (Platform Designer systems only)	Synthesis caching file that compares the .qsys and .ip files with the current parameterization of the Platform Designer system and IP core. This comparison determines if Platform Designer can skip regeneration of the HDL.
<your_ip>.csv	Contains information about the upgrade status of the IP component.
<your_ip>.bsf	A symbol representation of the IP variation for use in Block Diagram Files (.bdf).
<your_ip>.spd	Input file that ip-make-simscript requires to generate simulation scripts. The .spd file contains a list of files you generate for simulation, along with information about memories that you initialize.
<your_ip>.ppf	The Pin Planner File (.ppf) stores the port and node assignments for IP components you create for use with the Pin Planner.
<your_ip>_bb.v	Use the Verilog blackbox (_bb.v) file as an empty module declaration for use as a blackbox.
<your_ip>_inst.v or _inst.vhd	HDL example instantiation template. Copy and paste the contents of this file into your HDL file to instantiate the IP variation.
<your_ip>.regmap	If the IP contains register information, the Intel Quartus Prime software generates the .regmap file. The .regmap file describes the register map information of master and slave interfaces. This file complements the .sopcinfo file by providing more detailed register information about the system. This file enables register display views and user customizable statistics in System Console.
<your_ip>.svd	Allows HPS System Debug tools to view the register maps of peripherals that connect to HPS within a Platform Designer system. During synthesis, the Intel Quartus Prime software stores the .svd files for slave interface visible to the System Console masters in the .sof file in the debug session. System Console reads this section, which Platform Designer queries for register map information. For system slaves, Platform Designer accesses the registers by name.
<your_ip>.v <your_ip>.vhd	HDL files that instantiate each submodule or child IP core for synthesis or simulation.
mentor/	Contains a msim_setup.tcl script to set up and run a ModelSim* simulation.
aldec/	Contains a Riviera-PRO* script rivierapro_setup.tcl to setup and run a simulation.
/synopsys/vcs /synopsys/vcsmx	Contains a shell script vcs_setup.sh to set up and run a VCS* simulation. Contains a shell script vcsmx_setup.sh and synopsys_sim.setup file to set up and run a VCS MX simulation.
/cadence	Contains a shell script ncsim_setup.sh and other setup files to set up and run an NCSim simulation.
/xcelium	Contains an Xcelium* Parallel simulator shell script xcelium_setup.sh and other setup files to set up and run a simulation.
/submodules	Contains HDL files for the IP core submodule.
<IP submodule>/	Platform Designer generates /synth and /sim sub-directories for each IP submodule directory that Platform Designer generates.

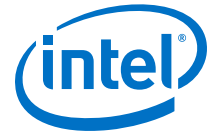

3.7. IP Core Generation Output (Intel Quartus Prime Standard Edition)

The Intel Quartus Prime Standard Edition software generates one of the following output file structures for individual IP cores that use one of the legacy parameter editors.

Figure 6. IP Core Generated Files (Legacy Parameter Editors)

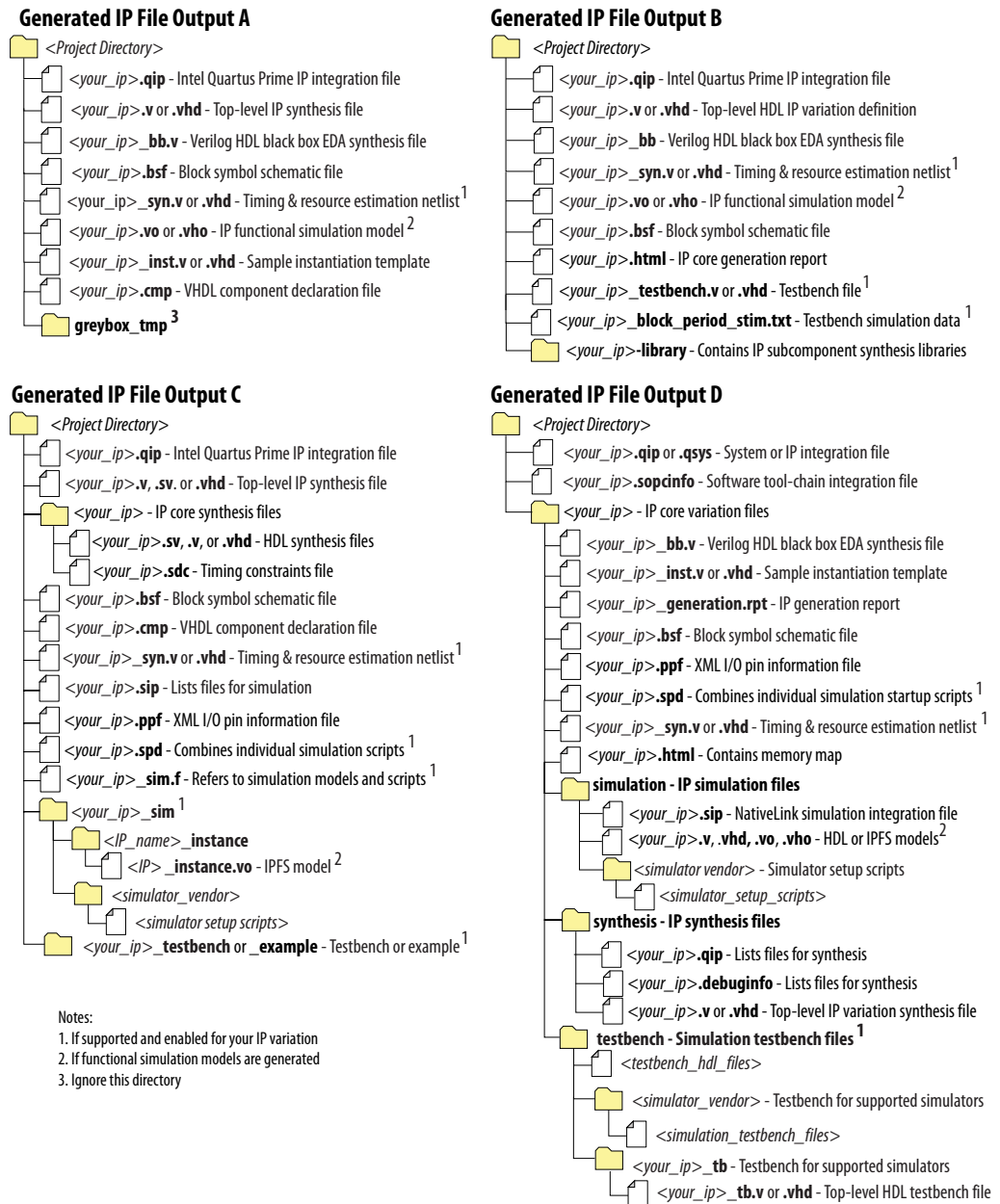



3.8. Simulating

3.8.1. Simulating Intel FPGA IP Cores

The Intel Quartus Prime software supports IP core RTL simulation in specific EDA simulators. IP generation creates simulation files, including the functional simulation model, any testbench (or example design), and vendor-specific simulator setup scripts for each IP core. Use the functional simulation model and any testbench or example design for simulation. IP generation output may also include scripts to compile and run any testbench. The scripts list all models or libraries you require to simulate your IP core.

The Intel Quartus Prime software provides integration with many simulators and supports multiple simulation flows, including your own scripted and custom simulation flows. Whichever flow you choose, IP core simulation involves the following steps:

1. Generate simulation model, testbench (or example design), and simulator setup script files.
2. Set up your simulator environment and any simulation scripts.
3. Compile simulation model libraries.
4. Run your simulator.

3.8.2. Simulation Parameters

After design generation, simulation files are available for you to simulate your design. To simulate your design, ensure that the Serial Lite III Streaming IP core source and sink cores are both generated with the same parameters or are duplex cores.

- Stratix V and Arria V GZ files are located in the <variation name>_sim directory
- Intel Arria 10 and Intel Stratix 10 files are located in the <variation name> directory

The example testbench simulates the core using the user-specified configuration.

Table 14. Stratix V and Arria V GZ Testbench Default Simulation Parameters

Parameter	Default Value	Comments
user clock frequency output (user_clock_frequency)	Standard clocking: 145.98375 MHz Advanced clocking: 146.484375 MHz	—
Number of lanes (lanes)	2	—
Transceiver reference clock frequency (pll_ref_freq)	644.53125 MHz	—
Transceiver data rate (data_rate)	10312.5 Mbps	—
Meta frame length in words (meta_frame_length)	200	—
Simulation-specific parameters		
Total samples to transfer (total_samples_to_transfer)	2000	Total samples to transfer during simulation.
<i>continued...</i>		

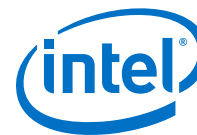

Parameter	Default Value	Comments
Mode (mode)	Continuous/burst	The testbench environment may automatically choose one of the modes depending on the random seed with which it is provided.
Skew insertion enable (skew_insertion_enable)	Yes	Skew testing is enabled. The testbench environment randomly inserts skew in the lanes within the range 0 - 107 UI.
Enable M20K ECC support (ecc_enable)	0	When set, the core is simulated with the ECC-enabled variant. Use the ECC-enabled variant in the test environment. When ECC mode is disabled, the two most significant bits of the error buses in the source or sink direction are <i>Don't Care</i> .

Table 15. Intel Arria 10 Testbench Default Simulation Parameters

Parameter	Default Value	Comments
user clock frequency output (user_clock_frequency)	Standard clocking: 146.484375 MHz	—
Number of lanes (lanes)	2	—
Transceiver reference clock frequency (pll_ref_freq)	644.531187 MHz	—
Transceiver data rate (data_rate)	10.312499 Gbps	—
Meta frame length in words (meta_frame_length)	200	—
Simulation-specific parameters		
Total samples to transfer (total_samples_to_transfer)	2000	Total samples to transfer during simulation.
Mode (mode)	Continuous/burst	The testbench environment may automatically choose one of the modes depending on the random seed with which it is provided.
Skew insertion enable (skew_insertion_enable)	Yes	Skew testing is enabled. The testbench environment randomly inserts skew in the lanes within the range 0 - 107 UI.
Enable M20K ECC support (ecc_enable)	0	When set, the core is simulated with the ECC-enabled variant. Use the ECC enabled variant in the test environment. When ECC mode is disabled, the two most significant bits of the error buses in the source or sink direction are <i>Don't Care</i> .

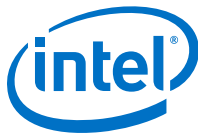

Table 16. Intel Stratix 10 Testbench Default Simulation Parameters

Parameter	Default Value	Comments
user clock frequency output (user_clock_frequency)	Standard clocking: 177.556818 MHz	—
Number of lanes (lanes)	6	—
Transceiver reference clock frequency (pll_ref_freq)	312.5 MHz	—
Transceiver data rate (data_rate)	12.5 Gbps	—
Meta frame length in words (meta_frame_length)	200	—
Simulation-specific parameters		
Total samples to transfer (total_samples_to_transfer)	2000	Total samples to transfer during simulation.
Mode (mode)	Continuous/burst	The testbench environment may automatically choose one of the modes depending on the random seed with which it is provided.
Skew insertion enable (skew_insertion_enable)	Yes	Skew testing is enabled. The testbench environment randomly inserts skew in the lanes within the range 0 - 107 UI.
Enable M20K ECC support (ecc_enable)	0	When set, the core is simulated with the ECC-enabled variant. Use the ECC enabled variant in the test environment. When ECC mode is disabled, the two most significant bits of the error buses in the source or sink direction are Don't Care.

For more information about Intel FPGA simulation models, refer to the Volume 3 of the Intel Quartus Prime Handbook.

Related Information

[Simulating Altera Designs](#)

3.8.3. Simulating and Verifying the Design

By default, the parameter editor generates simulator-specific scripts containing commands to compile, elaborate, and simulate Intel FPGA IP models and simulation model library files. You can copy the commands into your simulation testbench script, or edit these files to add commands for compiling, elaborating, and simulating your design and testbench.

Table 17. Intel FPGA IP Core Simulation Scripts

Simulator	File Directory	Device Family	Script
ModelSim - Intel FPGA Edition	<variation name>_sim/mentor	Stratix V Arria V GZ	msim_setup.tcl ⁽³⁾
ModelSim - Intel FPGA Starter Edition	<variation name>/sim/mentor	Intel Arria 10 Intel Stratix 10	
			<i>continued...</i>

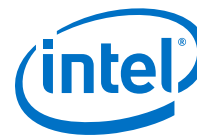

Simulator	File Directory	Device Family	Script
VCS	<variation name>_sim/synopsys/vcs	Stratix V Arria V GZ	vcs_setup.sh
	<variation name>/sim/synopsys/vcs	Intel Arria 10 Intel Stratix 10	
VCS MX	<variation name>_sim/synopsys/vcsmx	Stratix V Arria V GZ	vcsmx_setup.sh synopsys_sim.s etup
	<variation name>/sim/synopsys/vcsmx	Intel Arria 10 Intel Stratix 10	
NCSim	<variation name>_sim/cadence	Stratix V Arria V GZ	ncsim_setup.sh
	<variation name>/sim/cadence	Intel Arria 10 Intel Stratix 10	
Riviera-PRO	<variation name>_sim/aldec	Stratix V Arria V GZ	rivierapro_set.t cl
	<variation name>/sim/aldec	Intel Arria 10 Intel Stratix 10 <i>Note: This simulator is not supported for E-Tile transceiver.</i>	
Xcelium	<variation name>_sim/xcelium	Intel Arria 10 Intel Stratix 10	xcelium_setup. sh

Related Information

- [Simulating Altera Designs](#)
For more information about Altera simulation models.
- [Simulation Quick-Start for ModelSim - Intel FPGA Edition.](#)

(3) If you did not set up the EDA tool option— which enables you to start third-party EDA simulators from the Intel Quartus Prime software—run this script in the ModelSim-Intel FPGA Simulator Tcl console (not in the Intel Quartus Prime software Tcl console) to avoid any errors.

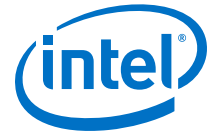

4. Serial Lite III Streaming IP Core Design Examples

Intel offers design examples that you can simulate, compile, and test in hardware.

The implementation of the Serial Lite III Streaming IP on hardware requires additional components specific to the targeted device.

4.1. Serial Lite III Streaming IP Core Design Example for Intel Stratix 10 Devices

The Serial Lite III Streaming IP core offers design examples that you can generate through the IP catalog in the Intel Quartus Prime Pro Edition software.

For detailed information about the Serial Lite III Streaming IP design examples, refer to *Serial Lite III Streaming IP Core Design Example User Guide for Intel Stratix 10 Devices*.

Related Information

[Serial Lite III Streaming IP Core Design Example User Guide for Intel Stratix 10 Devices](#)

4.2. Serial Lite III Streaming IP Core Design Example for Intel Arria 10 Devices

The Serial Lite III Streaming IP core offers design examples that you can generate through the IP catalog in the Intel Quartus Prime Pro Edition software.

For detailed information about the Serial Lite III Streaming IP design examples, refer to *Serial Lite III Streaming IP Core Design Example User Guide for Intel Arria 10 Devices*.

Related Information

[Serial Lite III Streaming IP Core Design Example User Guide for Intel Arria 10 Devices](#)

4.3. Serial Lite III Streaming IP Design Examples for Stratix V Devices

The Serial Lite III Streaming IP core offers design examples that you can generate through the IP catalog in the Intel Quartus Prime software.

For detailed information about the Serial Lite III Streaming IP design examples, refer to *Stratix V Serial Lite III Streaming IP Core Design Example User Guide*.

Related Information

[Stratix V Serial Lite III Streaming IP Core Design Example User Guide](#)

Intel Corporation. All rights reserved. Agilix, Altera, Arria, Cyclone, Enpirion, Intel, the Intel logo, MAX, Nios, Quartus and Stratix words and logos are trademarks of Intel Corporation or its subsidiaries in the U.S. and/or other countries. Intel warrants performance of its FPGA and semiconductor products to current specifications in accordance with Intel's standard warranty, but reserves the right to make changes to any products and services at any time without notice. Intel assumes no responsibility or liability arising out of the application or use of any information, product, or service described herein except as expressly agreed to in writing by Intel. Intel customers are advised to obtain the latest version of device specifications before relying on any published information and before placing orders for products or services.

*Other names and brands may be claimed as the property of others.

5. Serial Lite III Streaming IP Core Functional Description

The Serial Lite III Streaming IP core implements a protocol that defines streaming data encapsulation at the link layer and data encoding at the physical layer. This protocol integrates transparently with existing hardware and provides a reliable data transfer mechanism in applications that do not need additional layers between the data link and application.

5.1. IP Core Architecture

The Serial Lite III Streaming IP core has three variations:

- *Source* (simplex transmitter)—formats streaming data from the user application and transmits the data over serial links.
- *Sink* (simplex receiver)—receives the serial stream data from serial links, removes any formatting information, and delivers the data to the user application.
- *Duplex* (transmitter and receiver)—composed of both the source and sink cores. The streaming data can be transmitted and received in both directions.

All three variations include the L-Tile/H-Tile Transceiver Native PHY Intel Stratix 10 FPGA IP core in Interlaken mode for Intel Stratix 10 devices, Transceiver Native PHY Intel Arria 10/Intel Cyclone 10 GX FPGA IP core in Interlaken mode in Intel Arria 10 devices, or Interlaken PHY v18.1 IP core for Stratix V and Arria V GZ devices that utilizes hardened PCS and PMA modules. Source only and sink only variants are not available if you select E-Tile as the transceiver. The source and sink cores use the Transceiver Native PHY or Interlaken PHY v18.1 IP cores in simplex mode, and the duplex core uses the Transceiver Native PHY or Interlaken PHY v18.1 IP core in duplex mode.

Table 18. IP Core and Functions

Source Core	Sink Core
<ul style="list-style-type: none"> • Data encapsulation • Generation and insertion of Idle Control Words • Lane striping for multi-lane link • User synchronization and burst marker insertion 	<ul style="list-style-type: none"> • Multi-lane alignment • Data decapsulation • Idle Control Words removal • Lane de-striping • User synchronization and burst marker demultiplexing

Figure 7. Serial Lite III Streaming IP core with Source and Sink Cores

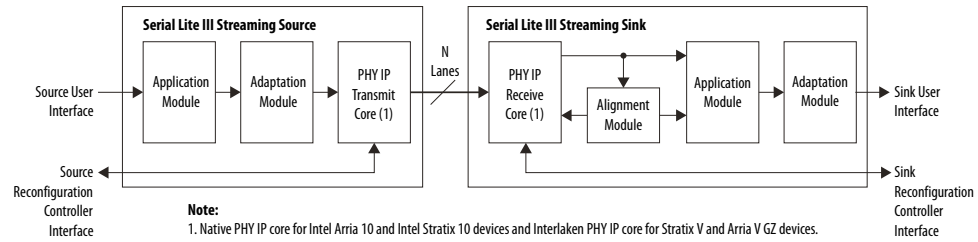
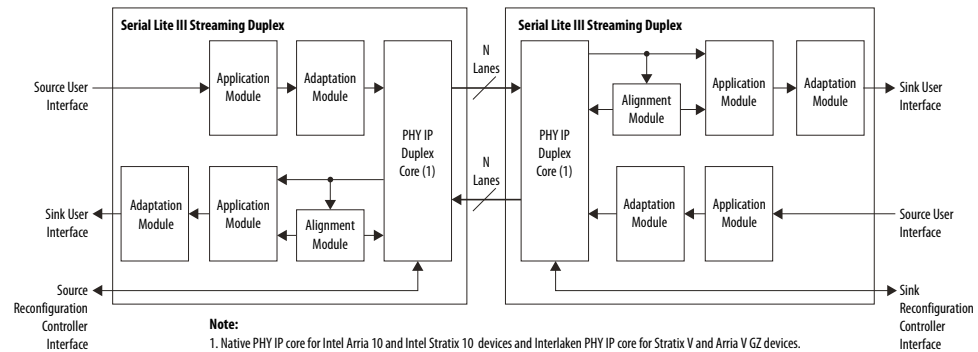

Figure 8. Serial Lite III Streaming IP Core Duplex Core



Related Information

- [Intel Arria 10 Transceiver PHY User Guide](#)
For more information about the Intel Arria 10 Native PHY IP core.
- [Intel Stratix 10 L- and H-Tile Transceiver PHY User Guide](#)
For more information about the Stratix 10 L- and H-Tile Native PHY IP core.
- [Intel Stratix 10 E-Tile Transceiver PHY User Guide](#)
For more information about the Intel Stratix 10 E-Tile Native PHY IP core.
- [V-Series Transceiver PHY IP Core User Guide](#)

5.1.1.1. Serial Lite III Streaming Source Core

The source core consists of four major functional blocks (the implementation varies depending on the clocking mode):

- Source application module
- Source adaptation module
- L-Tile/H-Tile Transceiver Native PHY Intel Stratix 10 FPGA IP and Transceiver Native PHY IP TX core for Intel Arria 10 - Interlaken mode
- Interlaken PHY v18.1 IP TX core (Stratix V and Arria V GZ devices)
- Clock generator (in the standard clocking mode for Intel Arria 10, Stratix V, and Arria V GZ devices)

Related Information

- [Standard Clocking Mode in Serial Lite III Streaming Intel FPGA IP Core \(Intel Stratix 10 Devices\)](#) on page 75

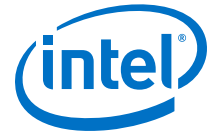

- [Standard Clocking Mode in Intel Arria 10, Stratix V, and Arria V Devices](#) on page 79
- [Advanced Clocking Mode Structure for Serial Lite III Streaming Intel FPGA IP Core \(Intel Stratix 10 Devices\)](#) on page 82
- [Advanced Clocking Mode Structure For Intel Arria 10, Stratix V, and Arria V Devices](#) on page 85

5.1.1.1. Source Application Module

The application module performs the following functions:

- *Burst encapsulation*—inserts burst control words into the data stream to define the beginning and the end of streaming data bursts.
- *Idle insertion*—inserts idle control words into all lanes of the data stream interface.

5.1.1.2. Source Adaptation Module

This module provides adaptation logic between the application module and the L-Tile/H-Tile Transceiver Native PHY Intel Stratix 10 FPGA IP core or Transceiver Native PHY in Intel Arria 10 devices or Interlaken PHY v18.1 IP (Stratix V and Arria V GZ devices) core. The adaptation module performs the following functions:

- *Rate adaptation*—includes a dual-clock FIFO buffer to cushion the Interlaken PHY v18.1 IP core's burst read requests and to provide a streaming user write interface. The FIFO also transfers streaming data between the `user_clock` and `tx_coreclk` clock domains.
- *Control signal translation*—include state machines that map the control signal semantics on the framing interface⁽⁴⁾ to the semantics of the Transceiver Native PHY or Interlaken PHY v18.1 IP core TX interface.
- *Non-user idle insertion*—inserts non-user idle control words in the absence of user data to manage the minimum data rate requirements of the Interlaken protocol. The control words are removed by the sink adaptation module in the Serial Lite III Streaming IP core link partner.
- *ECC correction and ECC fatal error detection*

5.1.1.3. Interlaken PHY IP TX Core or Native PHY IP TX Core - Interlaken Mode

For Intel Arria 10 and Intel Stratix 10 with L-tile and H-tile devices, this block is an instance of the Native PHY IP core configured for Interlaken - TX only operation. The PMA width for Interlaken mode is 64 bits.

For Stratix V and Arria V GZ devices, the Interlaken PHY IP TX core is an instance of the Interlaken PHY IP core configured for TX only operation. The PMA width for Interlaken mode is 40 bits. The core requires a Transceiver Reconfiguration Controller for transceiver calibration. The number of channels programmed for configuration in the Transceiver Reconfiguration Controller depends on the IP core's operation mode. For example, if the design is a source core only design or a duplex core design, the reconfiguration interfaces is equal to the number of lanes x 2.

⁽⁴⁾ The framing interface is to frame every data burst with the Start of Burst, Sync, and End of Burst, and sequence them to the PHY interface.

Related Information

- [Intel Arria 10 Transceiver PHY User Guide](#)
For more information about the Intel Arria 10 Native PHY IP core.
- [Intel Stratix 10 L- and H-Tile Transceiver PHY User Guide](#)
For more information about the Stratix 10 L- and H-Tile Native PHY IP core.
- [Intel Stratix 10 E-Tile Transceiver PHY User Guide](#)
For more information about the Intel Stratix 10 E-Tile Native PHY IP core.
- [V-Series Transceiver PHY IP Core User Guide](#)
For more information about the Interlaken PHY IP core and reconfiguration controller.

5.1.1.4. Source Clock Generator

When you use standard clocking mode for the user interface, the IP core provides a clock generator to generate the user clock (`user_clock`) and the Intel Arria 10 Transceiver Native PHY (`tx_coreclockin`) or Interlaken PHY v18.1 IP (`tx_clkout`) core clock signals. This clock generator consists of a fPLL (Stratix V and Arria V GZ) or I/O PLL (Intel Arria 10) and a state machine responsible for clocks generation and reset sequencing. The `user_clock_reset` is not released until the fPLL or I/O PLL is locked. The module is used in the standard clocking mode only.

Note: For Intel Stratix 10 devices, the `tx_clkout` signal provides the clock for L-Tile/H-Tile Transceiver Native PHY Intel Stratix 10 IP core clock signal (`tx_coreclockin`) because there is no clock generator module in the Serial Lite III Streaming IP core.

Figure 9. Clock Generator Block Diagram

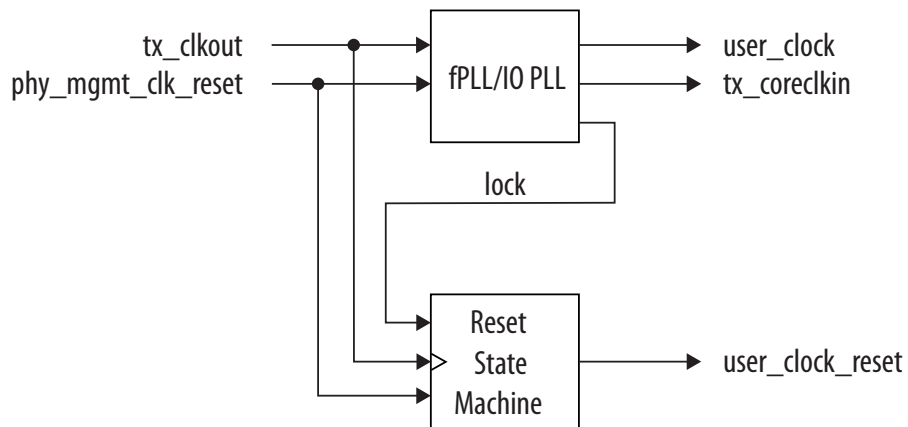

- For all Stratix V and Arria V GZ devices, the fPLL generates the `user_clock/`
`user_clock_tx` and `tx_coreclk` based on fixed ratios determined by the Serial Lite III Streaming parameter editor.
- For Intel Arria 10 devices, the I/O PLL generates the `user_clock/`
`user_clock_tx` based on a fixed ratio, however, the `tx_coreclk` operates at the same frequency as `tx_clkout`.

Related Information

- [Standard Clocking Mode in Serial Lite III Streaming Intel FPGA IP Core \(Intel Stratix 10 Devices\)](#) on page 75

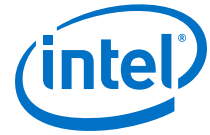

- [Standard Clocking Mode in Intel Arria 10, Stratix V, and Arria V Devices](#) on page 79
- [Advanced Clocking Mode Structure for Serial Lite III Streaming Intel FPGA IP Core \(Intel Stratix 10 Devices\)](#) on page 82
- [Advanced Clocking Mode Structure For Intel Arria 10, Stratix V, and Arria V Devices](#) on page 85
- [Sink Clock Generator](#) on page 36

5.1.2. Serial Lite III Streaming Sink Core

The sink core consists of five major functional blocks:

- L-Tile/H-Tile Transceiver Native PHY Intel Stratix 10 FPGA IP and Transceiver Native PHY IP RX core for Intel Arria 10 - Interlaken mode
- Interlaken PHY v18.1 IP RX core (Stratix V or Arria V GZ devices)
- Lane alignment module
- Sink adaptation module (standard clocking mode only)
- Sink application module
- Clock generator (in the standard clocking mode for Intel Arria 10, Stratix V, and Arria V GZ devices)

Related Information

- [Standard Clocking Mode in Serial Lite III Streaming Intel FPGA IP Core \(Intel Stratix 10 Devices\)](#) on page 75
- [Standard Clocking Mode in Intel Arria 10, Stratix V, and Arria V Devices](#) on page 79
- [Advanced Clocking Mode Structure for Serial Lite III Streaming Intel FPGA IP Core \(Intel Stratix 10 Devices\)](#) on page 82
- [Advanced Clocking Mode Structure For Intel Arria 10, Stratix V, and Arria V Devices](#) on page 85

5.1.2.1. Sink Application Module

The sink application module performs the following functions:

- Strips the Interlaken protocol bursts encapsulation from the received parallel data stream and sends the data to the sink adaptation module.
- Decodes idle control words inserted by the source application module when the data stream is not available and indicates the data unavailability at the source by deasserting the output valid signal at the user interface.

The encapsulation stripping process removes burst control words that define the beginning and the end of streaming data bursts from the data stream. This process adjusts the received data stream to repack the data words into a contiguous sequence.

- In the standard clocking mode (pure streaming), the decoding process checks the received data stream to detect idle control words that the source application module inserts. When the sink application module detects the idle control words, it deasserts the valid signal on the user interface until it receives valid user streaming data.

- In the advanced clocking mode, the sink application module does not insert or delete any idle words. Instead, the sink application module deasserts the output valid signal to indicate an absence of data coming from the sink adaptation module.

5.1.2.2. Sink Adaptation Module

The sink adaptation module provides rate adaptation logic between the application module and the streaming interface. The adaptation module implements the following functions:

- In standard clocking mode, the FIFO buffers help transfer data between the `rx_coreclk` and `user_clock` domains.
- *Interlaken framing layer stripping*—strips Interlaken framing layer symbols and diagnostic control words from the data stream.

5.1.2.3. Lane Alignment Module

The lane alignment module interfaces with the Native PHY or Interlaken PHY IP core to access incoming data. This module removes lane skew from the incoming serial data streams and aligns various lanes using the Interlaken's synchronization marker. After alignment is achieved, the module continuously monitors the synchronization markers in the Interlaken meta frames for any loss of alignment.

5.1.2.4. Interlaken PHY IP RX Core or Native PHY IP RX Core - Interlaken Mode

For Intel Arria 10 and Intel Stratix 10 L-tile and H-tile devices, this block is an instance of the Native PHY IP core configured for Interlaken - RX only operation. The PMA width for Interlaken mode is 64 bits.

For Stratix V and Arria V GZ devices, the Interlaken module is an instance of the Interlaken PHY IP core configured for RX only operation, and is generated by the Intel Quartus Prime parameter editor. The core requires a Stratix V/Arria V GZ Transceiver Reconfiguration Controller for transceiver calibration. The reconfiguration interface size is initially equal to the number of transceiver channels that the sink core uses, which is the number of lanes. The PMA width is 40 bits.

Related Information

- [Intel Arria 10 Transceiver PHY User Guide](#)
For more information about the Intel Arria 10 Native PHY IP core.
- [Intel Stratix 10 L- and H-Tile Transceiver PHY User Guide](#)
For more information about the Stratix 10 L- and H-Tile Native PHY IP core.
- [Intel Stratix 10 E-Tile Transceiver PHY User Guide](#)
For more information about the Intel Stratix 10 E-Tile Native PHY IP core.
- [V-Series Transceiver PHY IP Core User Guide](#)
For more information about the Interlaken PHY IP core and reconfiguration controller.

5.1.2.5. Sink Clock Generator

The clock generator is similar to the clock generator in the source core, and is only instantiated in standard clocking mode. The clock generator synthesizes the user clock (`user_clock`) and core clock (`rx_coreclk`) signals from the Native PHY IP core



(Intel Arria 10 devices) or Interlaken PHY IP (Stratix V and Arria V GZ devices) core's output clock signal. The clock generator consists of a fPLL or I/O PLL and a state machine responsible for clock generation and reset sequencing.

Note: For Intel Stratix 10 devices, the `rx_clkout` signal provides the clock for core clock signal (`rx_coreclockin`) because there is no clock generator module in the IP core.

- For all Stratix V and Arria V GZ devices, the fPLL generates the `user_clock/` `user_clock_rx` and `rx_coreclk` based on fixed ratios determined by the IP core's parameter editor.
- For Intel Arria 10 devices, the I/OPLL generates the `user_clock/` `user_clock_rx` based on a fixed ratio, however, the `rx_coreclk` operates at the same frequency as `rx_clkout`.

Related Information

- [Standard Clocking Mode in Serial Lite III Streaming Intel FPGA IP Core \(Intel Stratix 10 Devices\)](#) on page 75
- [Standard Clocking Mode in Intel Arria 10, Stratix V, and Arria V Devices](#) on page 79
- [Advanced Clocking Mode Structure for Serial Lite III Streaming Intel FPGA IP Core \(Intel Stratix 10 Devices\)](#) on page 82
- [Advanced Clocking Mode Structure For Intel Arria 10, Stratix V, and Arria V Devices](#) on page 85
- [Source Clock Generator](#) on page 34

5.1.3. Serial Lite III Streaming IP Core Duplex Core

For Intel Arria 10 and Intel Stratix 10 devices, the duplex core consists of source and sink cores interfaced with the Transceiver Native PHY in Intel Arria 10 devices, L-Tile/H-Tile Transceiver Native PHY Intel Stratix 10, and Intel Stratix 10 E-Tile Transceiver Native PHY FPGA IP cores in PCS gearbox mode.

For Stratix V and Arria V GZ devices, the duplex core is composed of source and sink cores interfaced with the Interlaken PHY v18.1 IP core in duplex mode.

5.1.4. Interlaken PHY IP Duplex Core or Native PHY IP Duplex Core - Interlaken Mode or PCS Gearbox Mode

For Intel Arria 10 and Intel Stratix 10 devices, this block is an instance of the Native PHY IP core configured for duplex Interlaken operation. The PMA width for Interlaken mode is 64 bits.

For Stratix V and Arria V GZ devices, the Interlaken module is an instance of the Interlaken PHY IP core configured for duplex operation, and is generated by the Intel Quartus Prime parameter editor. The core requires a Stratix V/Arria V GZ Transceiver Reconfiguration Controller for transceiver calibration. The duplex core initially requires as many reconfiguration interfaces as the number of lanes that the IP core uses plus one for the TX PLL. The PMA width is 40 bits.

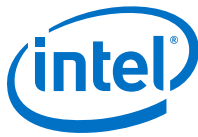
**Related Information**

- [Intel Arria 10 Transceiver PHY User Guide](#)
For more information about the Intel Arria 10 Native PHY IP core.
- [Intel Stratix 10 L- and H-Tile Transceiver PHY User Guide](#)
For more information about the Stratix 10 L- and H-Tile Native PHY IP core.
- [Intel Stratix 10 E-Tile Transceiver PHY User Guide](#)
For more information about the Intel Stratix 10 E-Tile Native PHY IP core.
- [V-Series Transceiver PHY IP Core User Guide](#)
For more information about the Interlaken PHY IP Core.

5.1.5. Intel Stratix 10, Intel Arria 10, Stratix V, and Arria V GZ Variations

The table summarizes the differences between the Serial Lite III Streaming IP cores in Intel Stratix 10, Intel Arria 10, Stratix V, and Arria V GZ devices.

Table 19. Differences between Intel Stratix 10, Intel Arria 10, Stratix V, and Arria V GZ

Implementation	Intel Stratix 10	Intel Arria 10	Stratix V/Arria V GZ
Internal clock generator for Standard Clocking Mode	Not included. User clock is provided by user. Use HSSI refclk to drive fPLL to generate the user clock. You must share the HSSI refclk with the L-tile/H-tile transceiver TX PLL refclk to eliminate PPM difference between user clock domain and core clock domain.	Included. The IP core uses IOPLL to generate the user clock.	Included. The IP core uses FPLL to generate the user clock.
Control Status Registers (CSR) for MAC	Included.	Not included. Only CSR for transceiver is available.	Not included. Only CSR for transceiver is available.
Interrupts	Included.	Not included.	Not included.
Transceiver transmit PLL	Not included	Not included.	Included.
Transceiver reconfiguration controller	Not required.	Not required.	Required.
PMA width	64	64	40
Hardware Demonstration Design Example	Included.	Included.	Included (for Stratix V only)

When you create an instance of the IP core, it dynamically generates an example testbench. This testbench has the same configuration as the IP core instance except for the Burst Gap parameter.

For Intel Arria 10 and Intel Stratix 10 L-tile/H-tile devices, the Native PHY IP core (Interlaken mode) requires an external transmit PLL. Instantiate the external transmit PLLs and then connect the transmit serial clock output to the `tx_serial_clk` input. The Serial Lite III Streaming IP core uses a transmit serial clock input bus (`tx_serial_clk`) and `tx_pll_locked` input to connect the external transmit PLL to the Intel Arria 10 Native PHY IP core. Refer to the *Intel Arria 10 Transceiver PHY User Guide* and *Intel Stratix 10 L- and H-Tile Transceiver PHY User Guide* for more information.



Related Information

- [Standard Clocking Mode in Serial Lite III Streaming Intel FPGA IP Core \(Intel Stratix 10 Devices\)](#) on page 75
- [Standard Clocking Mode in Intel Arria 10, Stratix V, and Arria V Devices](#) on page 79
- [Advanced Clocking Mode Structure for Serial Lite III Streaming Intel FPGA IP Core \(Intel Stratix 10 Devices\)](#) on page 82
- [Advanced Clocking Mode Structure For Intel Arria 10, Stratix V, and Arria V Devices](#) on page 85
- [Signals](#) on page 52
- [Intel Arria 10 Transceiver PHY User Guide](#)
For more information about the Intel Arria 10 Native PHY IP core.
- [V-Series Transceiver PHY IP Core User Guide](#)
For more information about the Interlaken PHY IP Core.
- [AN809: Intel FPGA SerialLite III IP Core Feature and Interface Differences between Intel Stratix 10, Intel Arria 10, and Stratix V](#)

5.2. Transmission Overheads and Lane Rate Calculations

The Serial Lite III Streaming IP core lane data rate (transceiver data rate) is composed of the input data rate and transmission overheads.

```
Lane Rate = Input Data Rate + Transmission Overheads (10% of Input Data Rate)
```

The parameter editor uses the above equation to ensure that the lane rate is within the maximum supported transceiver lane rates. This puts an upper limit on the input data rate or the user clock frequency, where the user clock frequency equates to:

```
User Clock Frequency = Input Data Rate/64
```

The Serial Lite III Streaming IP core uses the Interlaken protocol for transferring data and therefore incurs encoding and metaframe overheads.

In the standard clocking mode, the IP core employs an fPLL or I/O PLL for clock generation. To ensure that the fPLL or I/O PLL generates the clock as close as possible to the user clock that you have specified, the fPLL or I/O PLL incurs additional overheads. The transmission overheads can thus be derived in the following functions:

```
Transmission Overheads = Maximum (Interlaken Overheads + fPLL or I/O PLL Overheads)  
where Interlaken Overheads = [MetaFrame Length / (MetaFrame length - 4)] * 67/64
```

Therefore, the IP core standard clocking mode lane data rate can be calculated with the following equation:

```
Lane Data Rate in Standard Clocking Mode = (User Clock Frequency × 64) × 1.1  
where 1.1 is referring to additional 10% of Input Data Rate as the transmission overheads.
```

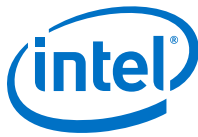

In the advanced clocking mode, the transmission overheads equals the Interlaken overheads because no fPLL or IOPLL is present. Therefore, the lane rate in advanced clocking mode equals:

$$\text{Lane Rate} = \text{Input Data Rate} \times \text{Interlaken overheads}$$

Tip: You can obtain the Serial Lite III Streaming IP Core Function Data Efficiency Calculator for 28 nm Intel FPGA devices from your local Intel sales representative.

Table 20. Example of Transmission Overheads and Lane Rate Calculations per Clocking Modes

This example is based on 12.5 Gbps lane rate with metaframe length of 200.

Parameters	Standard Clocking Mode	Advanced Clocking Mode
Lane rate	12.5 Gbps	12.5 Gbps
Interlaken overheads	$[\text{Metaframe length}/(\text{metaframe length} - 4)] * (67/64)$ $200 / (200 - 4) * (67/64) = 1.06824$	$[\text{Metaframe length}/(\text{metaframe length} - 4)] * (67/64)$ $200 / (200 - 4) * (67/64) = 1.06824$
Transmission overheads	1.1	Interlaken overheads
Input data rate	Lane rate/transmission overheads $12.5 \text{ Gbps}/1.1 = 11.364 \text{ Gbps}$	Lane rate/transmission overheads $12.5 \text{ Gbps}/1.06824 = 11.701 \text{ Gbps}$
User clock frequency	Input data rate/64 $11.364 \text{ Gbps}/64 = 177.5625 \text{ MHz}$	Input data rate/64 $11.701 \text{ Gbps}/64 = 182.828 \text{ MHz}$

5.3. Reset

Intel Arria 10, Stratix V and Arria V GZ Reset Scheme

Each core has a separate active high reset signal, `core_reset`, that asynchronously resets all logic in the core.

Each core also includes the Native PHY or Interlaken PHY IP reset signal, `phy_mgmt_clk_reset`. This reset signal must be on the same clock domain as the clock used to drive the reconfiguration controllers, `phy_mgmt_clk`. The Native PHY or Interlaken PHY IP core requires the assertion of this reset signal to synchronize with the reconfiguration controller reset signal.

Note: Intel recommends using the same reset signals for both the Native PHY or Interlaken PHY IP core and the reconfiguration controller.

When the `phy_mgmt_clk_reset` or `core_reset` signal is asserted on the source core, the sink deasserts the `link_up_rx` signal. However, there is no additional indication on the sink core whether the last transmitted burst has bad data. The source core reinitializes the internal reset sequence when the `phy_mgmt_clk_reset` or `core_reset` signal is deasserted. Once the internal reset sequence is complete, the core asserts the `link_up_tx` signal to indicate that the core initialization is complete and is ready to transmit user data.

Note: Intel recommends that you wait for an additional 30 μs on the source core before sending any valid Avalon streaming data cycle. This is to ensure that the sink core has sufficient time to assert the `link_up_rx` signal.

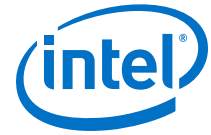

Intel Stratix 10 L-tile/H-tile Transceivers Reset Scheme

For Intel Stratix 10 L-tile/H-tile transceivers devices, the IP core uses the `phy_mgmt_clk_reset` signal to reset all the modules in the IP core and `user_clock_reset` signal to reset the user clock domain modules e.g. transmit and receive FIFO.

You may also trigger a reset to the IP core by writing into the reset controller register in the PHY:

- Writing 1 to CSR address 0x02E2 bit 3 to initiate a TX digital reset and bit 1 to initiate a RX digital reset
- Writing 1 to CSR address 0x02E2 bit 2 to initiate a TX analog reset and bit 0 to initiate a RX analog reset

Intel Stratix 10 E-tile Transceivers Reset Scheme

E-Tile transceivers have separate reset procedures for analog reset and digital reset.

You can use the PMA attribute code 0x0001 on the AVMM reconfiguration bus to enable or disable the PMA. Disabling the PMA puts it in reset. Digital reset can be asserted using the digital reset controller in the Native PHY IP.

Use the following guidelines to provide a proper reset to the IP core. These guidelines are applicable to Intel Stratix 10 L-tile/H-tile/E-tile transceivers devices:

- Use the same reset signals for both the source and sink user clock domain modules.
- Synchronize the `user_clock_reset` signals with `phy_mgmt_clock_reset` signal assertion.
- Use the `phy_mgmt_clk_reset` signal to reset the configuration and status registers.
- Ensure all clocks are toggling in a correct rate before de-asserting any reset signals.

Related Information

[Intel Stratix 10 E-Tile Transceiver PHY User Guide](#)

More information about resetting the Intel Stratix 10 E-Tile transceiver.

5.4. Link-Up Sequence

Link-up Sequence for Intel Stratix 10 L-tile/H-tile Transceivers, Intel Arria 10, Stratix V, and Arria V Devices

For source core:

1. The `phy_mgmt_clk_reset` signal de-asserts to indicate the Serial Lite III Streaming and Interlaken PHY IP or Native PHY IP cores are out of reset.
2. Next, the `tx_pll_locked` signal asserts to indicate that all external transceiver PLLs are locked.
3. The `link_up_tx` asserts to indicate that the Serial Lite III Streaming IP is ready to transmit data once the `tx_ready` signal from the Native PHY IP core for all lanes are asserted. During this time, the `user_clock_reset_tx` should be low.

For sink core:

1. The `phy_mgmt_clk_reset` signal de-asserts to indicate the Serial Lite III Streaming and Interlaken PHY IP or Native PHY IP cores are out of reset.
2. Next, the `rx_ready` signal from the Interlaken PHY IP or Native PHY IP cores, for all lanes asserts to indicate reset has complete for all RX lanes in the transceiver.
3. Then, the `link_up_rx` signal is asserted to indicate that the Serial Lite III Streaming is ready to receive data from user interface. During this time, the `user_clock_reset_rx` should be low.

The sequence is illustrated in the following diagram.

Figure 10. Serial Lite III Streaming IP Link Up Sequence

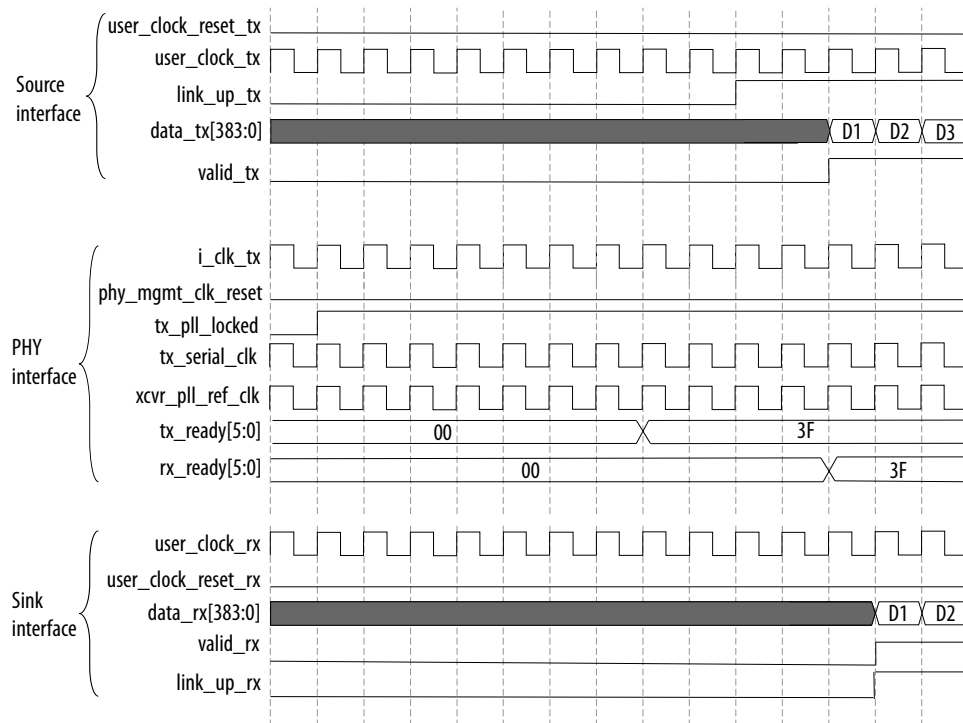

Link-up Sequence for Intel Stratix 10 E-tile Transceiver Devices

For source core:

1. The `phy_mgmt_clk_reset` signal de-asserts to indicate the Serial Lite III Streaming and Native PHY IP core are out of reset.
2. The `link_up_tx` asserts to indicate that the Serial Lite III Streaming IP is ready to transmit data once the `tx_ready` signal from the Native PHY IP core for all lanes are asserted. During this time, the `user_clock_reset_tx` should be low.

For sink core:

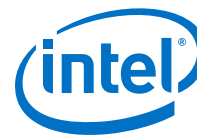

1. The `phy_mgmt_clk_reset` signal de-asserts to indicate the Serial Lite III Streaming and Native PHY IP core are out of reset.
2. Next, the `rx_ready` signal from the Interlaken PHY IP or Native PHY IP cores, for all lanes asserts to indicate reset has complete for all RX lanes in the transceiver.
3. Then, the `link_up_rx` signal is asserted to indicate that the Serial Lite III Streaming is ready to receive data from user interface. During this time, the `user_clock_reset_rx` should be low.

The sequence is illustrated in the following diagram.

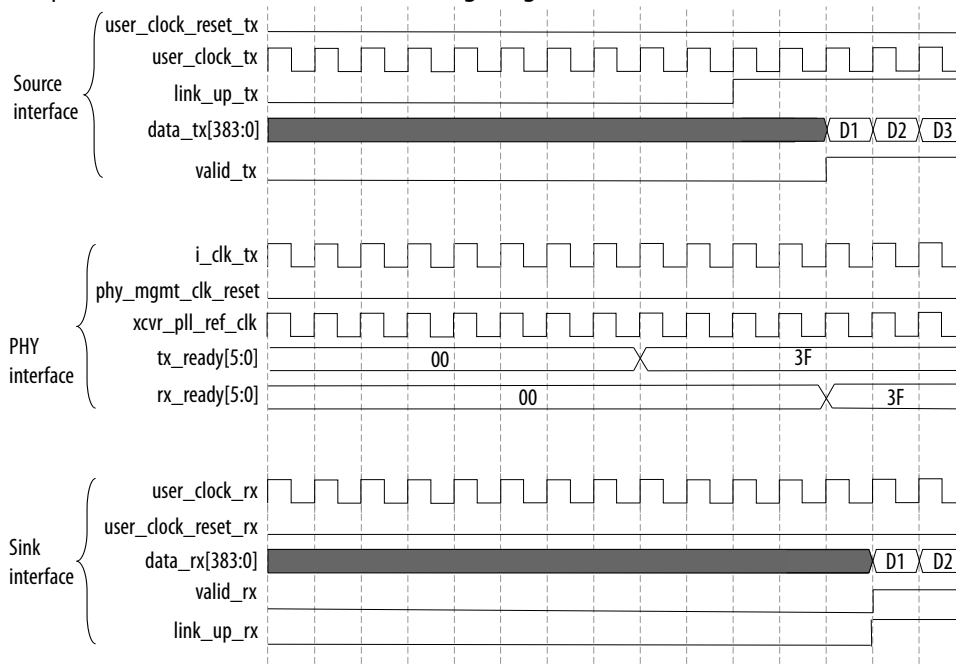

Related Information

- [Source Core Link Debugging](#) on page 103
- [Sink Core Link Debugging](#) on page 104

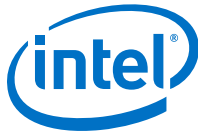

5.5. Error Detection, Reporting, and Recovering Mechanism

Table 21. Error Conditions, Core Behavior, Reporting, and Recovering Mechanism

This table lists the error conditions that the core detect, their behavior in response to each condition, and available reporting mechanisms.

Condition		IP Behavior	Reporting Mechanism	Recovering Mechanism
Source Core	Burst gap error	The source detects the burst gap between two consecutive bursts does not match Required idle cycles between bursts parameter setting. The source core asserts the error flag for one clock cycle.	<ul style="list-style-type: none"> tx_burst_gap_err of TX Error Status register set to 1 (only for Intel Stratix 10 devices). error/error_tx[3] signal asserted. err_interrupt/err_interrupt_tx signal asserted (only available when tx_burst_gap_err_en of TX Error Interrupt Enable register is set to 1 (only for Intel Stratix 10 devices). 	Make sure the burst gap of the incoming packet is matching the Required idle cycles between bursts parameter.
	Rate adaptation FIFO buffer overflow in source interface.	<p>There is an overflow on the rate adaptation FIFO buffer in the source interface. The core behavior depends on the operation mode:</p> <ul style="list-style-type: none"> Continuous mode—error is flagged once an overflow is detected. Burst mode—error is flagged only when an overflow occurs during burst data transfer across the user interface. <p>The source core asserts the error flag when the FIFO is in overflow condition.</p>	<ul style="list-style-type: none"> adapt_fifo_overflow of TX Error Status register set to 1 (only for Intel Stratix 10 devices). error/error_tx[0] signal asserted. err_interrupt/err_interrupt_tx signal asserted (only available when adapt_fifo_overflow_en of TX Error Interrupt Enable register is set to 1 (only for Intel Stratix 10 devices). 	<ul style="list-style-type: none"> Assert phy_mgmt_clk_reset to reset the IP. Send empty cycle to prevent FIFO overflow.

continued...

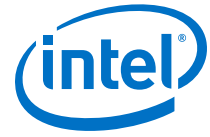

Condition		IP Behavior	Reporting Mechanism	Recovering Mechanism
	ECC fatal error.	The source core asserts the error flag for one clock cycle when a double bit error is detected.	<ul style="list-style-type: none"> • <code>adapt_fifo_overflow</code> of TX Error Status register set to 1 (only for Intel Stratix 10 devices). • <code>error/error_tx[0]</code> signal asserted. • <code>err_interrupt/err_interrupt_tx</code> signal asserted (only available when <code>ecc_err_fatal_en</code> of TX Error Interrupt Enable register is set to 1 (only for Intel Stratix 10 devices)). 	Assert <code>phy_mgmt_clk_reset</code> signal to reset the IP.
	ECC corrected error.	The source core asserts the error flag for one clock cycle when a single bit error is detected and corrected.	<ul style="list-style-type: none"> • <code>ecc_err_corrected</code> of TX Error Status register set to 1 (only for Intel Stratix 10 devices). • <code>error/error_tx[1]</code> signal asserted. • <code>err_interrupt/err_interrupt_tx</code> signal asserted (only available when <code>ecc_err_corrected_en</code> of TX Error Interrupt Enable register is set to 1 (only for Intel Stratix 10 devices)). 	—
	Source lost of lane alignment error	The source core detects a loss of lane alignment during normal operation.	<ul style="list-style-type: none"> • <code>tx_sync_done_lost</code> of TX Error Status register set to 1 (only for Intel Stratix 10 devices). • <code>err_interrupt/err_interrupt_tx</code> signal asserted (only available when <code>tx_sync_donest_en</code> of TX Error Interrupt Enable register is set to 1 (only for Intel Stratix 10 devices)). 	The source core automatically re-initialize the link when this error occurs. Optionally, you can assert <code>phy_mgmt_clk_reset</code> to reset the IP.

continued...



Condition		IP Behavior	Reporting Mechanism	Recovering Mechanism
Sink Core	RX data error	When the sink interface receives data but <code>ready_rx</code> signal is de-asserted.	<ul style="list-style-type: none"> <code>rx_data_err</code> of RX Error Status register set to 1 (only for Intel Stratix 10 devices). <code>err_interrupt/err_interrupt_rx</code> signal asserted (only available when <code>rx_data_err_int_en</code> of RX Error Interrupt Enable register is set to 1 (only for Intel Stratix 10 devices)). 	—
	Lane deskew fatal error	The sink core detects an error when the lane skews across all lanes exceeded the hardware de-skew capability.	<ul style="list-style-type: none"> <code>rx_deskew_fatal</code> of RX Error Status register set to 1 (only for Intel Stratix 10 devices). <code>err_interrupt/err_interrupt_rx</code> signal asserted (only available when <code>rx_deskew_fatal_int_en</code> of RX Error Interrupt Enable register is set to 1 (only for Intel Stratix 10 devices)). 	Assert <code>phy_mgmt_clk_reset</code> to reset the IP. Ensure the board routing does not exceed 107 UI.
	ECC fatal error.	The sink core asserts the error flag for one clock cycle when a double bit error is detected.	<ul style="list-style-type: none"> <code>ecc_err_fatal</code> of RX Error Status register set to 1 (only for Intel Stratix 10 devices). <code>error/error_rx[N+4]</code> signal asserted. <code>err_interrupt/err_interrupt_rx</code> signal asserted (only available when <code>ecc_err_fatal_int_en</code> of RX Error Interrupt Enable register is set to 1 (only for Intel Stratix 10 devices)). 	Assert <code>phy_mgmt_clk_reset</code> signal to reset the IP.

continued...

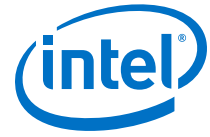

Condition		IP Behavior	Reporting Mechanism	Recovering Mechanism
	ECC corrected error.	The sink core asserts the error flag for one clock cycle when a single bit error is detected and corrected.	<ul style="list-style-type: none"> • <code>ecc_err_corrected</code> of RX Error Status register set to 1 (only for Intel Stratix 10 devices). • <code>error/error_rx[N+3]</code> signal asserted. • <code>err_interrupt/err_interrupt_rx</code> signal asserted (only available when <code>ecc_err_corrected_int_en</code> of RX Error Interrupt Enable register is set to 1 (only for Intel Stratix 10 devices)). 	—
	Rate adaptation FIFO buffer overflow	There is an overflow on the rate adaptation FIFO buffer in the sink interface. The core behavior depends on the operation mode: <ul style="list-style-type: none"> • Continuous mode—error is flagged once an overflow is detected. • Burst mode—error is flagged only when an overflow occurs during burst data transfer across the user interface. The sink core asserts the error flag when the FIFO is in overflow condition.	<ul style="list-style-type: none"> • <code>adapt_fifo_overflow</code> of RX Error Status register set to 1 (only for Intel Stratix 10 devices). • <code>error/error_rx[N+2]</code> signal asserted. • <code>err_interrupt/err_interrupt_rx</code> signal asserted (only available when <code>adapt_fifo_overflow_int_en</code> of RX Error Interrupt Enable register is set to 1 (only for Intel Stratix 10 devices)). 	—

continued...

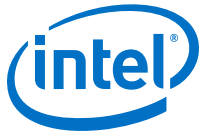

Condition		IP Behavior	Reporting Mechanism	Recovering Mechanism
	Lane alignment failure during normal operation	The sink core detects a loss of lane alignment during normal operation. The sink core asserts error[N] ⁽⁵⁾ flag for one clock cycle.	<ul style="list-style-type: none"> rx_alignment_lock of RX Error Status register set to 1 (only for Intel Stratix 10 devices). error/error_rx[N] signal asserted. err_interrupt/err_interrupt_rx signal asserted (only available when rx_alignment_lock_int_en of RX Error Interrupt Enable register is set to 1 (only for Intel Stratix 10 devices). 	The sink core automatically re-initialize and re-align the link. Optionally, you can assert phy_mgmt_clk_reset to reset the IP.
	RX PCS Error	One or more errors have occurred in a given meta-frame, as determined by Native PHY PCS logic (in Interlaken mode). These errors could be triggered much later (with respect to the user packets received earlier) at the receiving link. <i>Note:</i> If data integrity is critical, additional error checksum may be included in the user logic as part of data payload so that the downstream user logic can determine the data integrity at packet level.	<ul style="list-style-type: none"> rx_pcs_err of RX Error Status register set to 1 (only for Intel Stratix 10 devices). error/error_rx[N-1:0] signal asserted. err_interrupt/err_interrupt_rx signal asserted (only available when rx_pcs_err_int_en of RX Error Interrupt Enable register is set to 1 (only for Intel Stratix 10 devices). 	—
	Diagnostic code word CRC-32 error	The sink core detects a metaframe CRC-32 error on one of the lanes. These errors are reported on a per-lane basis for diagnostic purposes. The sink core asserts error[N-1:0] ⁽⁵⁾ flag for one clock cycle.	<ul style="list-style-type: none"> rx_crc32err of RX Error Status register set to 1 (only for Intel Stratix 10 devices). error/error_rx[N-1:0] signal asserted. err_interrupt/err_interrupt_rx signal asserted (only available when rx_crc32err_int_en of RX Error Interrupt Enable register is set to 1 (only for Intel Stratix 10 devices). 	—

⁽⁵⁾ N is the number of lanes.



5.6. CRC-32 Error Injection

In the Intel Quartus Prime software version 13.1 and later, the Serial Lite III Streaming IP core supports CRC error injection with the 10G PCS CRC-32 generator. This feature enables corruption of the CRC-32 value of the CRC-32 generator.

To insert CRC errors for a given lane, the IP interface includes a CRC error injection control signal. Asserting this control signal inserts CRC errors for all the lanes and transceivers that have enabled support for error injection. You can enable the CRC error injection for a specific transceiver channel (Serial Lite III Streaming lane) by programming the appropriate transceiver PCS CRAM bit. The provided example design demonstrates how set the respective CRAM bits using the Nios II processor.

For proper functionality of this feature, you must verify that you are adhering to the following steps:

1. Verify both `link_up_tx` and `link_up_rx` are asserted.
2. Verify the user can send/receive normal traffic.
3. After link up, program the transceiver register and verify the register bit (PCS CRAM bit) by reading.
4. With link up, toggle `crc_error_inject` port to high on the transmitter.
5. Monitor the `error_rx` output on the receiver.

Related Information

- [Intel FPGA Serial Lite III Streaming IP Core Design Example User Guide for Intel Stratix 10 Devices](#)
- [Intel Arria 10 Serial Lite III Streaming IP Core Design Example User Guide](#)

5.7. FIFO ECC Protection

In the Quartus II software version 13.1 and later, the Serial Lite III Streaming IP core can be protected from Single-Event Upset (SEU) changes using error correcting code (ECC) protection. You can enable this feature using the ECC protection option in the parameter editor. The ECC protection provides additional error status bits that tell you if the ECC was able to perform a correction from the SEU change or if an uncorrectable error has occurred.

Note: Enabling ECC protection incurs additional logic and latency overhead.

5.8. User Data Interface Waveforms

The following waveforms apply to the Serial Lite III Streaming IP core source user interface in source-only and duplex cores.

Figure 11. Source Waveform for Burst Mode

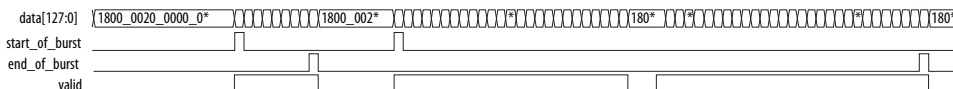

Figure 12. Source Waveform for Burst Mode (Sync)

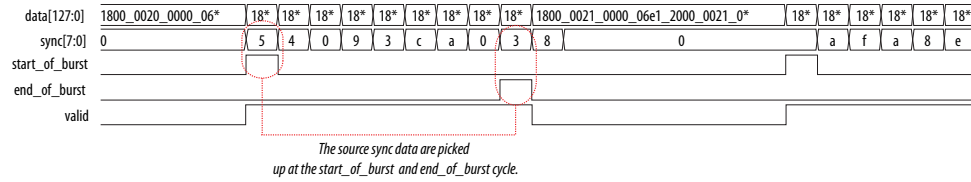
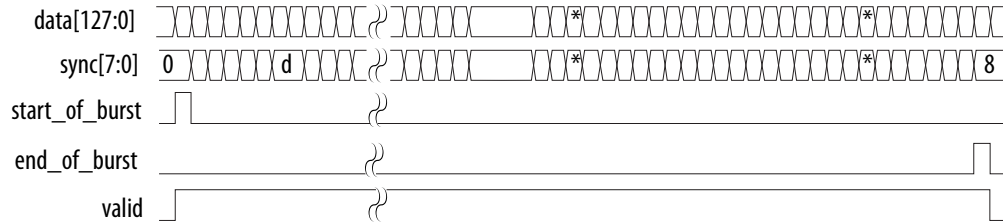

Figure 13. Source Waveform for Continuous Mode



- start_of_burst pulses for one clock cycle, indicating that the data burst starts at that clock cycle.
- end_of_burst pulses for one clock cycle, indicating that the data burst ends at that clock cycle.
- The valid signal indicates valid data. It should be turned off between two data bursts that are between the current data burst's end_of_burst clock cycle and next data burst's start_of_burst clock cycle. The valid signal can be pulled low in the middle of a data burst transferring between the same data burst's start_of_burst and end_of_burst, indicating non-valid data at that clock cycle.
- The sync vector is used in burst mode. It is valid only when start_of_burst and valid are high. Multiple logical channel is time-multiplexed into physical channels. Sync vector can be used to store the logical channel number that the burst targets. The logical channel number is multiplexed into the sync vector during the start_of_burst. The value is embedded into the data and sent over to the receiving party. The sink can extract the channel number from start_of_burst data bus to output on the sync vector of the sink. The sync vector can also be used to include empty information which indicates invalid data at the end_of_burst. In this case, the empty value is multiplexed into the sync vector during end_of_burst. The data is again embedded inside and sent over to the receiving party. The sink extracts the information and output on the sync vector of the sink.

The following waveforms apply to the sink user interface in sink-only and duplex cores.

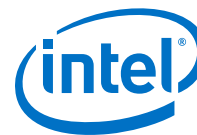

Figure 14. Sink Waveform for Burst Mode

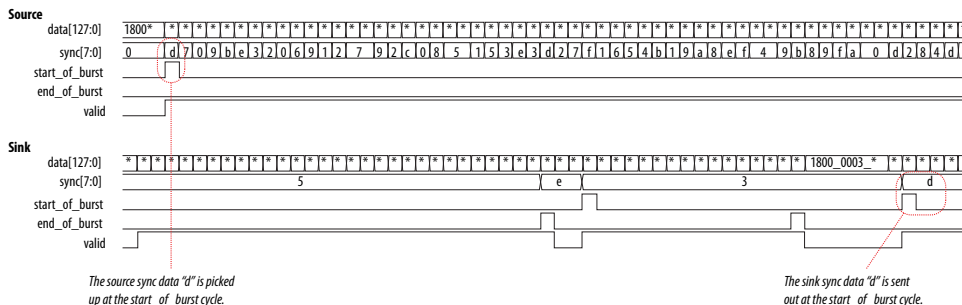
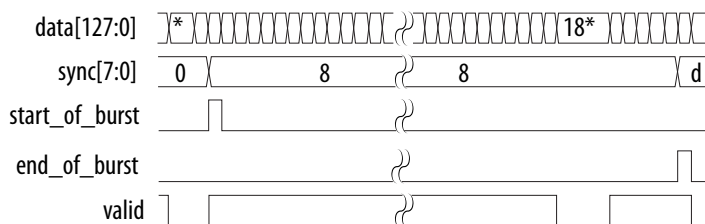
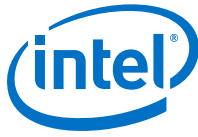

Figure 15. Sink Waveform for Continuous Mode



- `start_of_burst` pulses for one clock cycle, indicating that the data burst starts at that clock cycle.
- `end_of_burst` pulses for one clock cycle, indicating that the data burst ends at that clock cycle.
- The `valid` signal indicates valid data. It is turned off between two data bursts that are between the current data burst's `end_of_burst` clock cycle and the next data burst's `start_of_burst` clock cycle. The `valid` signal can be pulled low in the middle of a data burst after a data burst's `start_of_burst` and before the data burst's `end_of_burst`, indicating non-valid data at that clock cycle.
- The `sync` vector is used in burst mode. The sync data picked up at the source's `start_of_burst` high cycle is sent out at the sink as shown in the waveform. Multiple logical channel is time-multiplexed into physical channels. Sync vector can be used to store the logical channel number that the burst targets. The logical channel number is multiplexed into the sync vector during the `start_of_burst`. The value is embedded into the data and sent over to the receiving party. The sink can extract the channel number from `start_of_burst` data bus to output on the sync vector of the sink. The sync vector can also be used to include empty information which indicates invalid data at the `end_of_burst`. In this case, the empty value is multiplexed into the sync vector during `end_of_burst`. The data is again embedded inside and sent over to the receiving party. The sink extracts the information and output on the sync vector of the sink.



5.9. Signals

The following tables list all the input and output signals of the Serial Lite III Streaming IP core.

5.9.1. Signals for Intel Stratix 10 Devices

Table 22. Serial Lite III Streaming Source Core Signals for Intel Stratix 10 L-tile and H-tile Devices

Signal	Width	Clock Domain	Direction	Description
tx_serial_clk	N	N/A	Input	This signal is a high-speed serial clock input from the external transceiver PLL. The width is the same as the number of lanes specified in the parameter editor. Each bit of the vector corresponds to serial clock of the transmit channel. N represents the number of lanes.
tx_pll_locked	1	N/A	Input	This signal indicates that all external transceiver PLLs are locked. If more than one external transceiver PLL is required for higher lanes, each instantiation outputs a bit that indicates whether the PLL providing the high-speed clock for a corresponding transceiver has achieved its lock status. The pll_locked output signal from the external transceiver PLLs should be ANDed together before being input to the IP core.
xcvr_pll_ref_clk	1	N/A	Input	This signal is the reference clock for the transceivers.
user_clock	1	N/A	Input/Output	Clock for data transfers across the source core interface. This is an input signal for standard and advanced clocking mode.
user_clock_reset	1	user_clock	Input/Output	Asserts this signal to reset all the user clock domain module. Available only in Standard Clocking Mode.
link_up	1	user_clock	Output	The core asserts this signal to indicate that the core initialization is complete and is ready to transmit user data.
data	$64 \times N$	user_clock	Input	This vector carries the transmitted streaming data to the core. N represents the number of lanes.
sync	8	user_clock	Input	The sync vector is an 8 bit bus. The data value at the start of a burst and the end of a burst are captured and transported across the link. The value at the end of a burst is to indicate the number of invalid 64-bit word in the previous data cycle. As such, for single-lane configuration, the value at the end of a burst is expected to be 0. <i>Note:</i> This vector is not associated with Interlaken channelization or flow control schemes.
valid	1	user_clock	Input	This single bit signal indicates that the transmitted streaming data is valid.
ready	1	user_clock	Output	On interfaces supporting backpressure, the source asserts ready to mark the cycles where transfers may take place. When this signal is asserted on cycle N , cycle $(N + \text{readLatency})$, where $\text{readLatency}=0$ is considered a ready cycle.

continued...

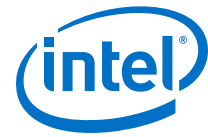

Signal	Width	Clock Domain	Direction	Description
				This signal is only asserted after tx_link_up is asserted. Leave unconnected if unused.
start_of_burst	1	user_clock	Input	When the core is in burst mode operation, asserting this signal indicates that the information on the data vector is the beginning of a burst. Because continuous mode is one long burst, in this mode the signal is asserted only once at the start of the data.
end_of_burst	1	user_clock	Input	When the core is in burst mode operation, asserting this signal indicates that the information on the data vector is the end of a burst. You can optionally send an end of burst signal at the end of continuous mode.
error	4	user_clock	Output	This vector indicates an error or overflow in the source adaptation module's FIFO buffer. <ul style="list-style-type: none"> Bit 0: Source adaptation module's FIFO buffer overflow Bit 1: An SEU error occurred and was corrected (ECC enabled) Don't care (ECC disabled) Bit 2: An SEU error occurred and cannot be corrected (ECC enabled) Don't care (ECC disabled) Bit 3: A burst gap error occurred due to a mismatch in the BURST_GAP parameter value and the gap between end of burst and start of burst.
crc_error_inject	1	user_clock	Input	This signal forces CRC-32 errors when CRC-32 error injection is enabled in the transceiver channels. The CRC-32 error injection is enabled via the transceiver reconfiguration controller.
err_interrupt	1	phy_mgmt_clk	Output	This signal indicates if a transmit error occurs in the current transmission. The signal goes to '1' when any error status bit and its associated interrupt enabled bit have been set to '1'. It goes to '0' after all error status bits with interrupt enabled have been cleared. Leave unconnected if unused.

Table 23. Serial Lite III Streaming Sink Core Signals for Intel Stratix 10 L-tile and H-tile Devices

Signal	Width	Clock Domain	Direction	Description
xcvr_pll_ref_clk	1	N/A	Input	Reference clock for the transceivers.
user_clock	1	N/A	Output	Clock for data transfers across the sink core interface in the standard clocking mode.
user_clock_reset	1	user_clock	Output	Asserts this signal to reset all the user clock domain module. Available only in Standard Clocking Mode.
interface_clock	1	core_clock	Output	Clock for data transfer across the sink core interface in the advanced clocking mode.
interface_clock_reset	1	core_clock	Output	The core asserts this signal when the phy_mgmt_clk_reset signal is high and deasserts this signal when the reset sequence is complete in the advanced clocking mode.

continued...

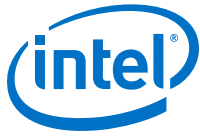

Signal	Width	Clock Domain	Direction	Description
				Available only in Advanced Clocking Mode.
link_up	1	Standard clocking: user_clock Advanced clocking: core_clock	Output	The core asserts this signal to indicate that the core initialization is complete and is ready to transmit user data. When this signal is deasserted, all values in the data_rx signal is invalid regardless of the valid_rx signal value. This means even when the valid_rx signal is asserted, the data_rx signal should be treated as invalid when link_up_rx is deasserted.
data	64xN	Standard clocking: user_clock Advanced clocking: core_clock	Output	This vector carries the transmitted streaming data from the core. N represents the number of lanes.
sync	8	Standard clocking: user_clock Advanced clocking: core_clock	Output	The sync vector is an 8 bit bus that reflects the SYNC value received from the remote partner. The value at the end of a burst is to indicate the number of invalid 64-bit word in the previous data cycle. As such, for single-lane configuration, the value at the end of a burst is expected to be 0. <i>Note:</i> This vector is not associated with Interlaken channelization or flow control schemes.
valid	1	Standard clocking: user_clock Advanced clocking: core_clock	Output	This single bit signal indicates that the data is valid.
start_of_burst	1	Standard clocking: user_clock Advanced clocking: core_clock	Output	When the core is in burst mode operation, assertion of this signal indicates that the information on the data vector is the beginning of a burst. Because continuous mode is one long burst, in this mode, the core asserts this signal only once at the start of the data.
end_of_burst	1	Standard clocking: user_clock Advanced clocking: core_clock	Output	When the core is in burst mode operation, assertion of this signal indicates that the information on the data vector is the end of a burst.

continued...

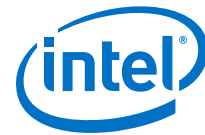

Signal	Width	Clock Domain	Direction	Description
error	$N+5$	Standard clocking: user_clock Advanced clocking: core_clock	Output	This vector indicates the state of the sink adaptation module's FIFO buffer. N represents the number of lanes: <ul style="list-style-type: none"> [$N+4$]: An SEU error occurred and cannot be corrected (ECC enabled); Don't care (ECC disabled) Don't care (for advanced clocking mode) [$N+3$]: An SEU error occurred and was corrected (ECC enabled); Don't care (ECC disabled) Don't care (for advanced clocking mode) [$N+2$]: Sink adaptation FIFO overflow Don't care (for advanced clocking mode) [$N+1$]: Don't care. Tied to zero. [N]: Loss of alignment [$N-1:0$]: PCS sync header, multiframe, or CRC-32 error
ready	1	Standard clocking: user_clock Advanced clocking: core_clock	Input	On interfaces supporting backpressure, the sink asserts ready to mark the cycles where transfers may take place. When this signal is asserted on cycle N , cycle ($N + \text{readLatency}$, where $\text{readLatency}=0$) is considered a ready cycle. If this signal de-asserts in the middle of a data transfer, it is considered an erroneous condition. Leave unconnected if unused.
err_interrupt	1	phy_mgmt_clk	Output	This signal indicates if a receive error as occur in the current transmission. The signal goes to '1' when any error status bit and its associated interrupt enabled bit have been set to '1'. It goes to '0' after all error status bits with interrupt enabled have been cleared. Leave unconnected if unused.

Table 24. Serial Lite III Streaming Duplex Core Signals for Intel Stratix 10 L-tile, H-tile, and E-tile Devices

Signal	Width	Clock Domain	Direction	Description
tx_serial_clk	N	N/A	Input	This high-speed serial clock input from the external transceiver PLL. The width is the same as the number of lanes specified in the parameter editor. Each bit of the vector corresponds to serial clock of the transmit channel. N represents the number of lanes. Note: This signal is not available when you select E-Tile as the transceiver tile.
tx_pll_locked	1	N/A	Input	This signal indicates that all external transceiver PLLs are locked. If more than one external transceiver PLL is required for higher lanes, each instantiation outputs a bit that indicates whether the PLL providing the high-speed clock for a corresponding transceiver has achieved its lock status. The <code>pll_locked</code> output signal from the external transceiver PLLs should be ANDed together before being input to the IP core. Note: This signal is not available when you select E-Tile as the transceiver tile.

continued...

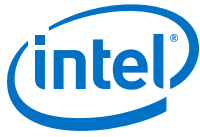

Signal	Width	Clock Domain	Direction	Description
xcvr_pll_ref_clk	1	N/A	Input	Reference clock for the transceivers.
user_clock_tx	1	N/A	Input	Clock for data transfers across the transmit interface.
user_clock_reset_tx	1	user_clock_tx	Input	In the standard clocking mode, the core asserts this signal when the phy_mgmt_clk_reset signal is high and deasserts this signal when the reset sequence is complete. In the advanced clocking mode, asserts this signal to reset all user clock domain modules.
link_up_tx	1	Standard clocking: user_clock Advanced clocking: core_clock	Output	The core asserts this signal to indicate that the core initialization is complete and is ready to transmit user data.
data_tx	64xN	Standard clocking: user_clock Advanced clocking: core_clock	Input	This vector carries the transmitted streaming data to the core. N represents the number of lanes.
sync_tx	8	Standard clocking: user_clock Advanced clocking: core_clock	Input	The sync vector is an 8 bit bus. The data value at the start of a burst and at the end of a burst are captured and transported across the link. The value at the end of a burst is to indicate the number of invalid 64-bit word in the previous data cycle. As such, for single-lane configuration, the value at the end of a burst is expected to be 0. <i>Note:</i> This vector is not associated with Interlaken channelization or flow control schemes.
valid_tx	1	Standard clocking: user_clock Advanced clocking: core_clock	Input	This vector indicates that the data is valid.
start_of_burst_tx	1	Standard clocking: user_clock Advanced clocking: core_clock	Input	When the core is in burst mode operation, assertion of this signal indicates that the information on the data vector is the beginning of a burst. Because continuous mode is one long burst, in this mode the signal is asserted only once at the start of the data.
end_of_burst_tx	1	Standard clocking: user_clock Advanced clocking: core_clock	Input	When the core is in burst mode operation, assertion of this signal indicates that the information on the data vector is the end of a burst.
error_tx	4	Standard clocking: user_clock Advanced clocking: core_clock	Output	This vector indicates an overflow in the source adaptation module's FIFO buffer. <ul style="list-style-type: none"> Bit 0: Source adaptation module's FIFO buffer overflow

continued...

5. Serial Lite III Streaming IP Core Functional Description

UG-01126 | 2020.05.05

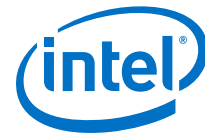

Signal	Width	Clock Domain	Direction	Description
				<ul style="list-style-type: none"> Bit 1: An SEU error occurred and was corrected (ECC enabled). Don't care (ECC disabled) Bit 2: An SEU error occurred and cannot be corrected (ECC enabled). Don't care (ECC disabled) Bit 3: A burst gap error occurred due to a mismatch in the <i>BURST GAP</i> parameter value and the gap between end of burst and start of burst.
err_interrupt_tx	1	phy_mgmt_clk	Output	This signal indicates if a transmit error occurs in the current transmission. The signal goes to '1' when any error status bit and its associated interrupt enabled bit have been set to '1'. It goes to '0' after all error status bits with interrupt enabled have been cleared. Leave unconnected if unused.
ready_tx	1	user_clock	Output	On interfaces supporting backpressure, the source asserts ready to mark the cycles where transfers may take place. When this signal is asserted on cycle <i>N</i> , cycle (<i>N</i> + readLatency, where readLatency=0) is considered a ready cycle. This signal is only asserted after tx_link_up is asserted Leave unconnected if unused.
user_clock_rx	1	N/A	Output	Clock for data transfers across the sink core interface in the standard clocking mode.
user_clock_reset_rx	1	user_clock_rx	Output	In the standard clocking mode, the core asserts this signal when the core_reset signal is high and deasserts this signal when the reset sequence is complete.
interface_clock_rx	1	core_clock	Output	Clock for data transfers across the sink core interface in the advanced clocking mode.
interface_clock_reset_rx	1	core_clock	Output	In the advanced clocking mode, the core asserts this signal when the core_reset signal is high and deasserts this signal when the reset sequence is complete.
link_up_rx	1	Standard clocking: user_clock Advanced clocking: core_clock	Output	The core asserts this signal to indicate that the core initialization is complete and is ready to transmit user data. When this signal is deasserted, all values in the data_rx signal is invalid regardless of the valid_rx signal value. This means even when the valid_rx signal is asserted, the data_rx signal should be treated as invalid when link_up_rx is deasserted.
data_rx	64x <i>N</i>	Standard clocking: user_clock Advanced clocking: core_clock	Output	This vector carries the transmitted streaming data from the core. <i>N</i> represents the number of lanes.
sync_rx	8	Standard clocking: user_clock	Output	The sync vector is an 8 bit bus that reflects the SYNC value received from the remote partner.
				<i>continued...</i>



Signal	Width	Clock Domain	Direction	Description
		Advanced clocking: core_clock		The value at the end of a burst is to indicate the number of invalid 64-bit word in the previous data cycle. As such, for single-lane configuration, the value at the end of a burst is expected to be 0. <i>Note:</i> This vector is not associated with Interlaken channelization or flow control schemes.
valid_rx	1	Standard clocking: user_clock Advanced clocking: core_clock	Output	This vector indicates that the data is valid.
start_of_burst_rx	1	Standard clocking: user_clock Advanced clocking: core_clock	Output	When the core is in burst mode operation, asserting this signal indicates that the information on the data vector is the beginning of a burst. Because continuous mode is one long burst, in this mode the signal is asserted only once at the start of the data.
end_of_burst_rx	1	Standard clocking: user_clock Advanced clocking: core_clock	Output	When the core is in burst mode operation, asserting this signal indicates that the information on the data vector is the end of a burst. You can optionally send an end of burst signal at the end of continuous mode.
error_rx	N+5	Standard clocking: user_clock Advanced clocking: core_clock	Output	This vector indicates the state of the sink adaptation module's FIFO buffer. <i>N</i> represents the number of lanes: <ul style="list-style-type: none"> [N+4]: An SEU error occurred and cannot be corrected (ECC enabled); Don't care (ECC disabled) Don't care (for advanced clocking mode) [N+3]: An SEU error occurred and was corrected (ECC enabled); Don't care (ECC disabled) Don't care (for advanced clocking mode) [N+2]: Sink adaptation FIFO overflow Don't care (for advanced clocking mode) [N+1]: Don't care. Tied to zero. [N]: Loss of alignment [N-1:0]: PCS sync header, multiframe, or CRC-32 error
ready_rx	1	Standard clocking: user_clock Advanced clocking: core_clock	Input	On interfaces supporting backpressure, the sink asserts ready to mark the cycles where transfers may take place. When this signal is asserted on cycle <i>N</i> , cycle (<i>N</i> + readLatency, where readLatency = 0) is considered a ready cycle If this signal de-asserts in the middle of a data transfer, it is considered an erroneous condition. Leave unconnected if unused.
err_interrupt_rx	1	phy_mgmt_clk	Output	This signal indicates if a receive error as occur in the current transmission. The signal goes to '1' when any error status bit and its associated interrupt enabled bit have been set to '1'. It goes to '0' after all error status bits with interrupt enabled have been cleared.

continued...

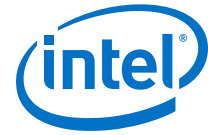

Signal	Width	Clock Domain	Direction	Description
				Leave unconnected if unused.
crc_error_inject	1	Standard clocking: user_clock_tx Advanced clocking: core_clock_tx	Input	This signal is used for CRC-32 error injection.

Table 25. L-Tile/H-Tile/E-Tile Transceiver Native PHY Intel Stratix 10 IP Core Signals (Interlaken Mode)

Signal	Width	Clock Domain	Direction	Description
phy_mgmt_clk	1	N/A	Input	Clock input for the Avalon memory-mapped PHY management interface within the INative PHY IP core. This signal also clocks the transceiver reconfiguration interface and sequences the reset state machine in the clock generation logic. Frequency ranges from 100 Hz - 150MHz.
phy_mgmt_clk_reset	1	phy_mgmt_clk	Input	Global reset signal that resets the entire IP including MAC, fPLL (L-tile/H-tile) or I/O PLL (E-tile) (available in standard clocking mode), andNative PHY IP core. This signal is active high and level sensitive.
phy_mgmt_addr	L/H-tile transceiver: 12 + log2N, N=number of lanes E-tile transceiver: 20 + log2N, N= number of lanes	phy_mgmt_clk	Input	Control and status register (CSR) address for Intel Stratix 10 devices. The width depends on the number of lanes. The parameter editor determines the required width for you. You have to manually tie this extra bit <ul style="list-style-type: none"> phy_mgmt_addr[msb] = 1: for Transceiver reconfiguration usage phy_mgmt_addr[msb] = 0: for soft CSR (the transceiver reset and loopback control CSR)
phy_mgmt_writedata[31:0]	32	phy_mgmt_clk	Input	CSR write data.
phy_mgmt_readdata[31:0]	32	phy_mgmt_clk	Output	CSR read data.
phy_mgmt_write	1	phy_mgmt_clk	Input	Active high CSR write signal.
phy_mgmt_read	1	phy_mgmt_clk	Input	Active high CSR read signal.
phy_mgmt_waitrequest	1	phy_mgmt_clk	Output	CSR read or write request signal. When asserted, this signal indicates that the Avalon memory-mapped slave interface is unable to respond to a read or write request.
tx_serial_data	N	—	Output	The serial output data from the core.

continued...

(6) For more information about this bit, refer to the Interlaken PHY Registers table in the Intel Stratix 10 L- and H-Tile Transceiver PHY User Guide and Intel Stratix 10 E-Tile Transceiver PHY User Guide.



Signal	Width	Clock Domain	Direction	Description
				<i>N</i> represents the number of lanes.
rx_serial_data	<i>N</i>	—	Input	The serial input data to the core. <i>N</i> represents the number of lanes.

Related Information

- [Intel Stratix 10 L- and H-Tile Transceiver PHY User Guide](#)
For more information about the Stratix 10 L- and H-Tile Native PHY IP core.
- [Intel Stratix 10 E-Tile Transceiver PHY User Guide](#)
For more information about the Intel Stratix 10 E-Tile Native PHY IP core.

5.9.2. Signals for Intel Arria 10 Devices

Note: For Intel Arria 10 devices, the phy_mgmt bus interface connects to the reconfiguration interface of the instantiated Native PHY IP core.

Table 26. Serial Lite III Streaming Intel Arria 10 IP Core Source Core Signals

Signal	Width	Clock Domain	Direction	Description
tx_serial_clk	<i>N</i>	N/A	Input	This signal is a high-speed serial clock input from the external transceiver PLL. The width is the same as the number of lanes specified in the parameter editor. Each bit of the vector corresponds to serial clock of the transmit channel. <i>N</i> represents the number of lanes.
tx_pll_locked	1	N/A	Input	This signal indicates that all external transceiver PLLs are locked. If more than one external transceiver PLL is required for higher lanes, each instantiation outputs a bit that indicates whether the PLL providing the high-speed clock for a corresponding transceiver has achieved its lock status. The pll_locked output signal from the external transceiver PLLs should be ANDed together before being input to the IP core.
core_reset	1	N/A	Input	Asynchronous master reset for the core. Assert this signal high to reset the MAC layer, except for the fPLL that is available in standard clocking mode. Intel recommends that you tie this signal to the phy_mgmt_clk_reset signal to reset the digital core, analog core, and the PLL core.
xcvr_pll_ref_clk	1	N/A	Input	This signal is present but unused in source-only variations; tie this signal to 1'b0.
user_clock	1	N/A	Input/Output	Clock for data transfers across the source core interface. <ul style="list-style-type: none"> • Input: Using advanced clocking mode • Output: Using standard clocking mode
user_clock_reset	1	user_clock	Input/Output	In the standard clocking mode, the core asserts this signal when the core_reset signal is high and deasserts this signal when the reset sequence is complete. In the advanced clocking mode, asserts this signal to reset the adaptation module FIFO buffer. <ul style="list-style-type: none"> • Input: Using advanced clocking mode • Output: Using standard clocking mode
<i>continued...</i>				

5. Serial Lite III Streaming IP Core Functional Description

UG-01126 | 2020.05.05

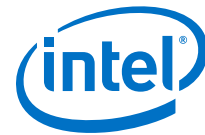

Signal	Width	Clock Domain	Direction	Description
interface_clock_reset	1	user_clock	Output	Clock for data transfer across the source core interface in the advanced clocking mode. Available only in Advanced Clocking Mode.
link_up	1	user_clock	Output	The core asserts this signal to indicate that the core initialization is complete and is ready to transmit user data.
data	64xN	user_clock	Input	This vector carries the transmitted streaming data to the core. N represents the number of lanes.
sync	8	user_clock	Input	The sync vector is an 8 bit bus. The data value at the start of a burst and the end of a burst are captured and transported across the link. The value at the end of a burst is to indicate the number of invalid 64-bit word in the previous data cycle. As such, for single-lane configuration, the value at the end of a burst is expected to be 0. <i>Note:</i> This vector is not associated with Interlaken channelization or flow control schemes.
valid	1	user_clock	Input	This single bit signal indicates that the transmitted streaming data is valid.
start_of_burst	1	user_clock	Input	When the core is in burst mode operation, asserting this signal indicates that the information on the data vector is the beginning of a burst. Because continuous mode is one long burst, in this mode the signal is asserted only once at the start of the data.
end_of_burst	1	user_clock	Input	When the core is in burst mode operation, asserting this signal indicates that the information on the data vector is the end of a burst. You can optionally send an end of burst signal at the end of continuous mode.
error	4	user_clock	Output	This vector indicates an error or overflow in the source adaptation module's FIFO buffer. <ul style="list-style-type: none"> Bit 0: Source adaptation module's FIFO buffer overflow Bit 1: An SEU error occurred and was corrected (ECC enabled) Don't care (ECC disabled) Bit 2: An SEU error occurred and cannot be corrected (ECC enabled) Don't care (ECC disabled) Bit 3: A burst gap error occurred due to a mismatch in the <i>BURST GAP</i> parameter value and the gap between end of burst and start of burst.
crc_error_inject	1	user_clock	Input	This signal forces CRC-32 errors when CRC-32 error injection is enabled in the transceiver channels. The CRC-32 error injection is enabled via the transceiver reconfiguration controller.

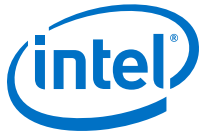
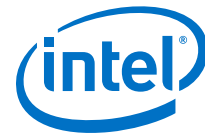

Table 27. Serial Lite III Streaming Intel Arria 10 IP Core Sink Core Signals

Signal	Width	Clock Domain	Direction	Description
core_reset	1	N/A	Input	Asynchronous master reset for the core. Assert this signal high to reset the MAC layer, except for the I/O PLL that is available in standard clocking mode. Intel recommends that you tie this signal to the <code>phy_mgmt_clk_reset</code> signal to reset the digital core, analog core, and the PLL core.
xcvr_pll_ref_clk	1	N/A	Input	Reference clock for the transceivers.
user_clock	1	N/A	Output	Clock for data transfers across the sink core interface in the standard clocking mode.
user_clock_reset	1	user_clock	Output	The core asserts this signal when the <code>core_reset</code> signal is high and deasserts this signal when the reset sequence is complete in the standard clocking mode.
interface_clock	1	core_clock	Output	Clock for data transfer across the sink core interface in the advanced clocking mode.
interface_clock_reset	1	core_clock	Output	The core asserts this signal when the <code>core_reset</code> signal is high and deasserts this signal when the reset sequence is complete. Available only in Advanced Clocking Mode.
link_up	1	Standard clocking: user_clock Advanced clocking: core_clock	Output	The core asserts this signal to indicate that the core initialization is complete and is ready to transmit user data. When this signal is deasserted, all values in the <code>data_rx</code> signal is invalid regardless of the <code>valid_rx</code> signal value. This means even when the <code>valid_rx</code> signal is asserted, the <code>data_rx</code> signal should be treated as invalid when <code>link_up_rx</code> is deasserted.
data	64xN	Standard clocking: user_clock Advanced clocking: core_clock	Output	This vector carries the transmitted streaming data from the core. N represents the number of lanes.
sync	8	Standard clocking: user_clock Advanced clocking: core_clock	Output	The sync vector is an 8 bit bus that reflects the SYNC value received from the remote partner. The value at the end of a burst is to indicate the number of invalid 64-bit word in the previous data cycle. As such, for single-lane configuration, the value at the end of a burst is expected to be 0. <i>Note:</i> This vector is not associated with Interlaken channelization or flow control schemes.
valid	1	Standard clocking: user_clock Advanced clocking: core_clock	Output	This single bit signal indicates that the data is valid.
start_of_burst	1	Standard clocking: user_clock	Output	When the core is in burst mode operation, assertion of this signal indicates that the information on the data vector is the beginning of a burst.

continued...



Signal	Width	Clock Domain	Direction	Description
		Advanced clocking: core_clock		Because continuous mode is one long burst, in this mode, the core asserts this signal only once at the start of the data.
end_of_burst	1	Standard clocking: user_clock Advanced clocking: core_clock	Output	When the core is in burst mode operation, assertion of this signal indicates that the information on the data vector is the end of a burst.
error	$N+5$	Standard clocking: user_clock Advanced clocking: core_clock	Output	This vector indicates the state of the sink adaptation module's FIFO buffer. N represents the number of lanes: <ul style="list-style-type: none"> [$N+4$]: An SEU error occurred and cannot be corrected (ECC enabled); Don't care (ECC disabled) Don't care (for advanced clocking) [$N+3$]: An SEU error occurred and was corrected (ECC enabled); Don't care (ECC disabled) Don't care (for advanced clocking mode) [$N+2$]: FIFO buffer overflow Don't care (for advanced clocking mode) [$N+1$]: Don't care. Tied to zero. [N]: Loss of alignment [$N-1:0$]: RX CRC 32 error

Table 28. Serial Lite III Streaming Intel Arria 10 IP Core Duplex Core Signals

Signal	Width	Clock Domain	Direction	Description
tx_serial_clk	N	N/A	Input	This high-speed serial clock input from the external transceiver PLL. The width is the same as the number of lanes specified in the parameter editor. Each bit of the vector corresponds to serial clock of the transmit channel. N represents the number of lanes.
tx_pll_locked	1	N/A	Input	This signal indicates that all external transceiver PLLs are locked. If more than one external transceiver PLL is required for higher lanes, each instantiation outputs a bit that indicates whether the PLL providing the high-speed clock for a corresponding transceiver has achieved its lock status. The <code>pll_locked</code> output signal from the external transceiver PLLs should be ANDed together before being input to the IP core.
core_reset	1	N/A	Input	Asynchronous master reset for the core. Assert this signal high to reset the MAC layer, except for the fPLL or I/O PLL that is available in standard clocking mode. Intel recommends that you tie this signal to the <code>phy_mgmt_clk_reset</code> signal to reset the digital core, analog core, and the PLL core.
xcvr_pll_ref_clk	1	N/A	Input	Reference clock for the transceivers.
user_clock_tx	1	N/A	Input/ Output	Clock for data transfers across the transmit interface. <ul style="list-style-type: none"> Input: Using advanced clocking mode Output: Using standard clocking mode
<i>continued...</i>				



Signal	Width	Clock Domain	Direction	Description
user_clock_reset_tx	1	user_clock_tx	Input/Output	In the standard clocking mode, the core asserts this signal when the core_reset signal is high and deasserts this signal when the reset sequence is complete. In the advanced clocking mode, asserts this signal to reset the adaptation module FIFO buffer. <ul style="list-style-type: none"> Input: Using advanced clocking mode Output: Using standard clocking mode
interface_clock_reset_tx	1	core_clock	Output	The core asserts this signal when the core_reset signal is high and deasserts this signal when the reset sequence is complete. Available only in Advanced Clocking Mode.
link_up_tx	1	Standard clocking: user_clock Advanced clocking: core_clock	Output	The core asserts this signal to indicate that the core initialization is complete and is ready to transmit user data.
data_tx	64xN	Standard clocking: user_clock Advanced clocking: core_clock	Input	This vector carries the transmitted streaming data to the core. N represents the number of lanes.
sync_tx	8	Standard clocking: user_clock Advanced clocking: core_clock	Input	The sync vector is an 8 bit bus. The data value at the start of a burst and at the end of a burst are captured and transported across the link. The value at the end of a burst is to indicate the number of invalid 64-bit word in the previous data cycle. As such, for single-lane configuration, the value at the end of a burst is expected to be 0. <i>Note:</i> This vector is not associated with Interlaken channelization or flow control schemes.
valid_tx	1	Standard clocking: user_clock Advanced clocking: core_clock	Input	This vector indicates that the data is valid.
start_of_burst_tx	1	Standard clocking: user_clock Advanced clocking: core_clock	Input	When the core is in burst mode operation, assertion of this signal indicates that the information on the data vector is the beginning of a burst. Because continuous mode is one long burst, in this mode the signal is asserted only once at the start of the data.
end_of_burst_tx	1	Standard clocking: user_clock Advanced clocking: core_clock	Input	When the core is in burst mode operation, assertion of this signal indicates that the information on the data vector is the end of a burst.
error_tx	4	Standard clocking: user_clock	Output	This vector indicates an overflow in the source adaptation module's FIFO buffer. <ul style="list-style-type: none"> Bit 0: Source adaptation module's FIFO buffer overflow

continued...

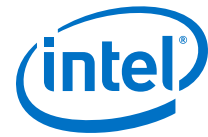

Signal	Width	Clock Domain	Direction	Description
		Advanced clocking: core_clock		<ul style="list-style-type: none"> Bit 1: An SEU error occurred and was corrected (ECC enabled). Don't care (ECC disabled) Bit 2: An SEU error occurred and cannot be corrected (ECC enabled). Don't care (ECC disabled) Bit 3: A burst gap error occurred due to a mismatch in the <i>BURST_GAP</i> parameter value and the gap between end of burst and start of burst.
user_clock_rx	1	N/A	Output	Clock for data transfers across the sink core interface in the standard clocking mode.
user_clock_reset_rx	1	user_clock_rx	Output	The core asserts this signal when the <code>core_reset</code> signal is high and deasserts this signal when the reset sequence is complete. Available only in Standard Clocking Mode.
interface_clock_rx	1	core_clock	Output	Clock for data transfers across the sink core interface in the advanced clocking mode.
interface_clock_reset_rx	1	core_clock	Output	The core asserts this signal when the <code>core_reset</code> signal is high and deasserts this signal when the reset sequence is complete. Available only in Advanced Clocking Mode.
link_up_rx	1	Standard clocking: user_clock Advanced clocking: core_clock	Output	The core asserts this signal to indicate that the core initialization is complete and is ready to transmit user data. When this signal is deasserted, all values in the <code>data_rx</code> signal is invalid regardless of the <code>valid_rx</code> signal value. This means even when the <code>valid_rx</code> signal is asserted, the <code>data_rx</code> signal should be treated as invalid when <code>link_up_rx</code> is deasserted.
data_rx	64xN	Standard clocking: user_clock Advanced clocking: core_clock	Output	This vector carries the transmitted streaming data from the core. N represents the number of lanes.
sync_rx	8	Standard clocking: user_clock Advanced clocking: core_clock	Output	The sync vector is an 8 bit bus that reflects the SYNC value received from the remote partner. The value at the end of a burst is to indicate the number of invalid 64-bit word in the previous data cycle. As such, for single-lane configuration, the value at the end of a burst is expected to be 0. <i>Note:</i> This vector is not associated with Interlaken channelization or flow control schemes.
valid_rx	1	Standard clocking: user_clock Advanced clocking: core_clock	Output	This vector indicates that the data is valid.
start_of_burst_rx	1	Standard clocking: user_clock Advanced clocking: core_clock	Output	When the core is in burst mode operation, asserting this signal indicates that the information on the data vector is the beginning of a burst. Because continuous mode is one long burst, in this mode the signal is asserted only once at the start of the data.

continued...



Signal	Width	Clock Domain	Direction	Description
end_of_burst_rx	1	Standard clocking: user_clock Advanced clocking: core_clock	Output	When the core is in burst mode operation, asserting this signal indicates that the information on the data vector is the end of a burst. You can optionally send an end of burst signal at the end of continuous mode.
error_rx	N+5	Standard clocking: user_clock Advanced clocking: core_clock	Output	This vector indicates the state of the sink adaptation module's FIFO buffer. N represents the number of lanes: <ul style="list-style-type: none"> [N+4]: An SEU error occurred and cannot be corrected (ECC enabled); Don't care (ECC disabled) Don't care (for advanced clocking mode) [N+3]: An SEU error occurred and was corrected (ECC enabled); Don't care (ECC disabled) Don't care (for advanced clocking mode) [N+2]: FIFO buffer overflow Don't care (for advanced clocking mode) [N+1]: Don't care. Tied to zero. [N]: Loss of alignment [N-1:0]: RX CRC 32 error
crc_error_inject	1	Standard clocking: user_clock_tx Advanced clocking: core_clock_tx	Input	This signal is used for CRC-32 error injection.

Table 29. Transceiver Native PHY Intel Arria 10 IP Core Signals (Interlaken Mode)

Signal	Width	Clock Domain	Direction	Description
phy_mgmt_clk	1	N/A	Input	Clock input for the Avalon memory-mapped PHY management interface within the Native PHY IP core. This signal also clocks the transceiver reconfiguration interface and sequences the reset state machine in the clock generation logic.
phy_mgmt_clk_reset	1	phy_mgmt_clk	Input	Global reset signal that resets the entire IP including MAC, I/O PLL (available in standard clocking mode), and Native PHY IP core. This signal is active high and level sensitive.
phy_mgmt_addr	10 + log ₂ N], N=number of lanes	phy_mgmt_clk	Input	Control and status register (CSR) address for Intel Arria 10 devices. The width depends on the number of lanes. The parameter editor determines the required width for you. You have to manually tie this extra bit ⁽⁷⁾ . <ul style="list-style-type: none"> phy_mgmt_addr[msb] = 1: for Transceiver reconfiguration usage. phy_mgmt_addr[msb] = 0: for soft CSR (the transceiver reset and loopback control CSR)

continued...

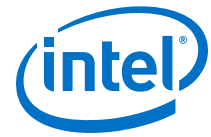

Signal	Width	Clock Domain	Direction	Description
phy_mgmt_writedata[31:0]	32	phy_mgmt_clk	Input	CSR write data.
phy_mgmt_readdata[31:0]	32	phy_mgmt_clk	Output	CSR read data.
phy_mgmt_write	1	phy_mgmt_clk	Input	Active high CSR write signal.
phy_mgmt_read	1	phy_mgmt_clk	Input	Active high CSR read signal.
phy_mgmt_waitrequest	1	phy_mgmt_clk	Output	CSR read or write request signal. When asserted, this signal indicates that the Avalon memory-mapped slave interface is unable to respond to a read or write request.
reconfig_busy	1	phy_mgmt_clk	Input	For Intel Arria 10 devices, this signal is present but unused; tie this signal to 1'b0.
tx_serial_data	<i>N</i>	—	Output	The serial output data from the core. <i>N</i> represents the number of lanes.
rx_serial_data	<i>N</i>	—	Input	The serial input data to the core. <i>N</i> represents the number of lanes.

Related Information

[Intel Arria 10 Transceiver PHY User Guide](#)

For more information about the Intel Arria 10 Native PHY IP core.

5.9.3. Signals for Stratix V and Arria V GZ Devices

Table 30. Serial Lite III Streaming IP Core Source Core Signals for Stratix V and Arria V GZ Devices

Signal	Width	Clock Domain	Direction	Description
core_reset	1	N/A	Input	Asynchronous master reset for the core. Assert this signal high to reset the MAC layer, except for the fPLL that is available in standard clocking mode. Intel recommends that you tie this signal to the phy_mgmt_clk_reset signal to reset the digital core, analog core, and the PLL core.
xcvr_pll_ref_clk	1	N/A	Input	This signal is the reference clock for the transceivers.
user_clock	1	N/A	Input/Output	Clock for data transfers across the source core interface. <ul style="list-style-type: none"> Input: Using advanced clocking mode Output: Using standard clocking mode
user_clock_reset	1	user_clock	Input/Output	In the standard clocking mode, the core asserts this signal when the core_reset signal is high and deasserts this signal when the reset sequence is complete.

continued...

(7) For more information about this bit, refer to the Interlaken PHY Registers table in the Altera Transceiver PHY IP Core User Guide.

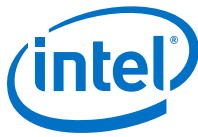

Signal	Width	Clock Domain	Direction	Description
				In the advanced clocking mode, asserts this signal to reset the adaptation module FIFO buffer. <ul style="list-style-type: none"> • Input: Using advanced clocking mode • Output: Using standard clocking mode
link_up	1	user_clock	Output	The core asserts this signal to indicate that the core initialization is complete and is ready to transmit user data.
data	64xN	user_clock	Input	This vector carries the transmitted streaming data to the core. N represents the number of lanes.
sync	8	user_clock	Input	The sync vector is an 8 bit bus. The data value at the start of a burst and the end of a burst are captured and transported across the link. The value at the end of a burst is to indicate the number of invalid 64-bit word in the previous data cycle. As such, for single-lane configuration, the value at the end of a burst is expected to be 0. <i>Note:</i> This vector is not associated with Interlaken channelization or flow control schemes.
valid	1	user_clock	Input	This single bit signal indicates that the transmitted streaming data is valid.
start_of_burst	1	user_clock	Input	When the core is in burst mode operation, asserting this signal indicates that the information on the data vector is the beginning of a burst. Because continuous mode is one long burst, in this mode the signal is asserted only once at the start of the data.
end_of_burst	1	user_clock	Input	When the core is in burst mode operation, asserting this signal indicates that the information on the data vector is the end of a burst. You can optionally send an end of burst signal at the end of continuous mode.
error	4	user_clock	Output	This vector indicates an error or overflow in the source adaptation module's FIFO buffer. <ul style="list-style-type: none"> • Bit 0: Source adaptation module's FIFO buffer overflow • Bit 1: An SEU error occurred and was corrected (ECC enabled) Don't care (ECC disabled) • Bit 2: An SEU error occurred and cannot be corrected (ECC enabled) Don't care (ECC disabled) • Bit 3: A burst gap error occurred due to a mismatch in the <i>BURST GAP</i> parameter value and the gap between end of burst and start of burst.
crc_error_inject	1	user_clock	Input	This signal forces CRC-32 errors when CRC-32 error injection is enabled in the transceiver channels. The CRC-32 error injection is enabled via the transceiver reconfiguration controller.

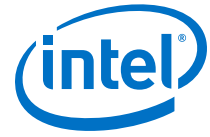
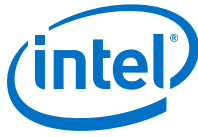

Table 31. Serial Lite III Streaming IP Core Sink Core Signals for Stratix V and Arria V GZ Devices

Signal	Width	Clock Domain	Direction	Description
core_reset	1	N/A	Input	Asynchronous master reset for the core. Assert this signal high to reset the MAC layer, except for the fPLL that is available in standard clocking mode. Intel recommends that you tie this signal to the <code>phy_mgmt_clk_reset</code> signal to reset the digital core, analog core, and the PLL core.
xcvr_pll_ref_clk	1	N/A	Input	Reference clock for the transceivers.
user_clock	1	N/A	Output	Clock for data transfers across the sink core interface in the standard clocking mode.
user_clock_reset	1	user_clock	Output	The core asserts this signal when the <code>core_reset</code> signal is high and deasserts this signal when the reset sequence is complete in the standard clocking mode.
interface_clock	1	core_clock	Output	Clock for data transfer across the sink core interface in the advanced clocking mode.
interface_clock_reset	1	core_clock	Output	The core asserts this signal when the <code>core_reset</code> signal is high and deasserts this signal when the reset sequence is complete in the advanced clocking mode.
link_up	1	Standard clocking: user_clock Advanced clocking: core_clock	Output	The core asserts this signal to indicate that the core initialization is complete and is ready to transmit user data. When this signal is deasserted, all values in the <code>data_rx</code> signal is invalid regardless of the <code>valid_rx</code> signal value. This means even when the <code>valid_rx</code> signal is asserted, the <code>data_rx</code> signal should be treated as invalid when <code>link_up_rx</code> is deasserted.
data	64xN	Standard clocking: user_clock Advanced clocking: core_clock	Output	This vector carries the transmitted streaming data from the core. N represents the number of lanes.
sync	8	Standard clocking: user_clock Advanced clocking: core_clock	Output	The sync vector is an 8 bit bus that reflects the SYNC value received from the remote partner. The value at the end of a burst is to indicate the number of invalid 64-bit word in the previous data cycle. As such, for single-lane configuration, the value at the end of a burst is expected to be 0. <i>Note:</i> This vector is not associated with Interlaken channelization or flow control schemes.
valid	1	Standard clocking: user_clock Advanced clocking: core_clock	Output	This single bit signal indicates that the data is valid.
start_of_burst	1	Standard clocking: user_clock	Output	When the core is in burst mode operation, assertion of this signal indicates that the information on the data vector is the beginning of a burst.

continued...



Signal	Width	Clock Domain	Direction	Description
		Advanced clocking: core_clock		Because continuous mode is one long burst, in this mode, the core asserts this signal only once at the start of the data.
end_of_burst	1	Standard clocking: user_clock Advanced clocking: core_clock	Output	When the core is in burst mode operation, assertion of this signal indicates that the information on the data vector is the end of a burst.
error	N+5	Standard clocking: user_clock Advanced clocking: core_clock	Output	This vector indicates the state of the sink adaptation module's FIFO buffer. <i>N</i> represents the number of lanes: <ul style="list-style-type: none"> [N+4]: An SEU error occurred and cannot be corrected (ECC enabled); Don't care (ECC disabled) Don't care (for advanced clocking mode) [N+3]: An SEU error occurred and was corrected (ECC enabled); Don't care (ECC disabled) Don't care (for advanced clocking mode) [N+2]: FIFO buffer overflow Don't care (for advanced clocking mode) [N+1]: Don't care. Tied to zero. [N]: Loss of alignment [N-1:0]: RX CRC 32 error

Table 32. Serial Lite III Streaming IP Core Duplex Core Signals for Stratix V and Arria V GZ Devices

Signal	Width	Clock Domain	Direction	Description
core_reset	1	N/A	Input	Asynchronous master reset for the core. Assert this signal high to reset the MAC layer, except for the fPLL that is available in standard clocking mode. Intel recommends that you tie this signal to the <code>phy_mgmt_clk_reset</code> signal to reset the digital core, analog core, and the PLL core.
xcvr_pll_ref_clk	1	N/A	Input	Reference clock for the transceivers.
user_clock_tx	1	N/A	Input/ Output	Clock for data transfers across the transmit interface. <ul style="list-style-type: none"> Input: Using advanced clocking mode Output: Using standard clocking mode
user_clock_reset_tx	1	user_clock_tx	Input/ Output	In the standard clocking mode, the core asserts this signal when the <code>core_reset</code> signal is high and deasserts this signal when the reset sequence is complete. In the advanced clocking mode, asserts this signal to reset the adaptation module FIFO buffer. <ul style="list-style-type: none"> Input: Using advanced clocking mode Output: Using standard clocking mode
interface_clock_reset_tx	1	core_clock	Output	In the advanced clocking mode, the core asserts this signal when the <code>core_reset</code> signal is high and deasserts this signal when the reset sequence is complete.

continued...

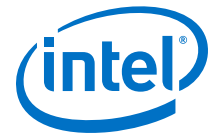

Signal	Width	Clock Domain	Direction	Description
link_up_tx	1	Standard clocking: user_clock Advanced clocking: core_clock	Output	The core asserts this signal to indicate that the core initialization is complete and is ready to transmit user data.
data_tx	64xN	Standard clocking: user_clock Advanced clocking: core_clock	Input	This vector carries the transmitted streaming data to the core. N represents the number of lanes.
sync_tx	8	Standard clocking: user_clock Advanced clocking: core_clock	Input	The sync vector is an 8 bit bus. The data value at the start of a burst and at the end of a burst are captured and transported across the link. The value at the end of a burst is to indicate the number of invalid 64-bit word in the previous data cycle. As such, for single-lane configuration, the value at the end of a burst is expected to be 0. <i>Note:</i> This vector is not associated with Interlaken channelization or flow control schemes.
valid_tx	1	Standard clocking: user_clock Advanced clocking: core_clock	Input	This vector indicates that the data is valid.
start_of_burst_tx	1	Standard clocking: user_clock Advanced clocking: core_clock	Input	When the core is in burst mode operation, assertion of this signal indicates that the information on the data vector is the beginning of a burst. Because continuous mode is one long burst, in this mode the signal is asserted only once at the start of the data.
end_of_burst_tx	1	Standard clocking: user_clock Advanced clocking: core_clock	Input	When the core is in burst mode operation, assertion of this signal indicates that the information on the data vector is the end of a burst.
error_tx	4	Standard clocking: user_clock Advanced clocking: core_clock	Output	This vector indicates an overflow in the source adaptation module's FIFO buffer. <ul style="list-style-type: none"> • Bit 0: Source adaptation module's FIFO buffer overflow • Bit 1: An SEU error occurred and was corrected (ECC enabled). Don't care (ECC disabled) • Bit 2: An SEU error occurred and cannot be corrected (ECC enabled). Don't care (ECC disabled) • Bit 3: A burst gap error occurred due to a mismatch in the <i>BURST_GAP</i> parameter value and the gap between end of burst and start of burst.
user_clock_rx	1	N/A	Output	Clock for data transfers across the sink core interface in the standard clocking mode.

continued...

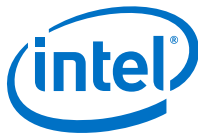

Signal	Width	Clock Domain	Direction	Description
user_clock_reset_rx	1	user_clock_rx	Output	In the standard clocking mode, the core asserts this signal when the <code>core_reset</code> signal is high and deasserts this signal when the reset sequence is complete.
interface_clock_rx	1	core_clock	Output	Clock for data transfers across the sink core interface in the advanced clocking mode.
interface_clock_reset_rx	1	core_clock	Output	In the advanced clocking mode, the core asserts this signal when the <code>core_reset</code> signal is high and deasserts this signal when the reset sequence is complete.
link_up_rx	1	Standard clocking: user_clock Advanced clocking: core_clock	Output	The core asserts this signal to indicate that the core initialization is complete and is ready to transmit user data. When this signal is deasserted, all values in the <code>data_rx</code> signal is invalid regardless of the <code>valid_rx</code> signal value. This means even when the <code>valid_rx</code> signal is asserted, the <code>data_rx</code> signal should be treated as invalid when <code>link_up_rx</code> is deasserted.
data_rx	64xN	Standard clocking: user_clock Advanced clocking: core_clock	Output	This vector carries the transmitted streaming data from the core. N represents the number of lanes.
sync_rx	8	Standard clocking: user_clock Advanced clocking: core_clock	Output	The sync vector is an 8 bit bus that reflects the SYNC value received from the remote partner. The value at the end of a burst is to indicate the number of invalid 64-bit word in the previous data cycle. As such, for single-lane configuration, the value at the end of a burst is expected to be 0. <i>Note:</i> This vector is not associated with Interlaken channelization or flow control schemes.
valid_rx	1	Standard clocking: user_clock Advanced clocking: core_clock	Output	This vector indicates that the data is valid.
start_of_burst_rx	1	Standard clocking: user_clock Advanced clocking: core_clock	Output	When the core is in burst mode operation, asserting this signal indicates that the information on the data vector is the beginning of a burst. Because continuous mode is one long burst, in this mode the signal is asserted only once at the start of the data.
end_of_burst_rx	1	Standard clocking: user_clock	Output	When the core is in burst mode operation, asserting this signal indicates that the information on the data vector is the end of a burst. You can optionally send an end of burst signal at the end of continuous mode.

continued...

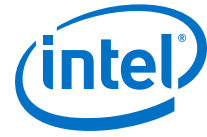

Signal	Width	Clock Domain	Direction	Description
		Advanced clocking: core_clock		
error_rx	N+5	Standard clocking: user_clock Advanced clocking: core_clock	Output	This vector indicates the state of the sink adaptation module's FIFO buffer. <i>N</i> represents the number of lanes: <ul style="list-style-type: none"> [N+4]: An SEU error occurred and cannot be corrected (ECC enabled); Don't care (ECC disabled) Don't care (for advanced clocking mode) [N+3]: An SEU error occurred and was corrected (ECC enabled); Don't care (ECC disabled) Don't care (for advanced clocking mode) [N+2]: FIFO buffer overflow Don't care (for advanced clocking mode) [N+1]: Don't care. Tied to zero. [N]: Loss of alignment [N-1:0]: RX CRC 32 error
crc_error_inject	1	Standard clocking: user_clock_tx Advanced clocking: core_clock_tx	Input	This signal is used for CRC-32 error injection.

Table 33. Interlaken PHY v18.1 IP Core Signals Core Signals for Stratix V and Arria V GZ Devices

Signal	Width	Clock Domain	Direction	Description
phy_mgmt_clk	1	N/A	Input	Clock input for the Avalon memory-mapped PHY management interface within the Interlaken PHY IP core. This signal also clocks the transceiver reconfiguration interface and sequences the reset state machine in the clock generation logic.
phy_mgmt_clk_reset	1	phy_mgmt_clk	Input	Global reset signal that resets the entire IP including MAC, fPLL (available in standard clocking mode), and Interlaken PHY IP core. This signal is active high and level sensitive.
phy_mgmt_addr[8:0]	9	phy_mgmt_clk	Input	Control and status register (CSR) address for Stratix V and Arria V GZ devices.
phy_mgmt_writedata[31:0]	32	phy_mgmt_clk	Input	CSR write data.
phy_mgmt_readdata[31:0]	32	phy_mgmt_clk	Output	CSR read data.
phy_mgmt_write	1	phy_mgmt_clk	Input	Active high CSR write signal.
phy_mgmt_read	1	phy_mgmt_clk	Input	Active high CSR read signal.

continued...

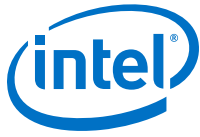

Signal	Width	Clock Domain	Direction	Description
phy_mgmt_waitrequest	1	phy_mgmt_clk	Output	CSR read or write request signal. When asserted, this signal indicates that the Avalon memory-mapped slave interface is unable to respond to a read or write request.
reconfig_busy	1	phy_mgmt_clk	Input	For Stratix V and Arria V GZ devices, when asserted, this signal indicates that a reconfiguration operation is in progress and no further reconfiguration operations should be performed. You can monitor this signal to determine the status of the Transceiver Reconfiguration Controller.
reconfig_to_xcvr	<ul style="list-style-type: none">Source core: 140xNSink core: 70xNDuplex core: 140xN	phy_mgmt_clk	Input	Dynamic reconfiguration input for the Interlaken PHY IP. N represents the number of lanes.
reconfig_from_xcvr	<ul style="list-style-type: none">Source core: 92xNSink core: 46xNDuplex core: 92xN	phy_mgmt_clk	Output	Dynamic reconfiguration output for the Interlaken PHY IP. N represents the number of lanes.
tx_serial_data	N	—	Output	The serial output data from the core. N represents the number of lanes.
rx_serial_data	N	—	Input	The serial input data to the core. N represents the number of lanes.

Related Information

- [V-Series Transceiver PHY IP Core User Guide](#)
- [Loopback Modes](#)

More information about pre- and post-CDR RX to TX serial loopback modes in the Transceiver Reconfiguration Controller IP Core.

5.10. Accessing Configuration and Status Registers

The Avalon memory-mapped PHY management block within the Interlaken PHY IP core or Native PHY IP core includes master and slave interfaces. This component acts as a bridge. It transfers commands received on its Avalon memory-mapped slave interface to its Avalon memory-mapped port. This interface manages PCS and PMA modules, resets, error handling, and serial loopback controls. Refer to [Configuration and Status Registers](#) on page 95 for more information of registers that you can access using the Avalon memory-mapped PHY management interface using word addresses and a 32-bit embedded processor. A single address space provides access to all registers.

6. Serial Lite III Streaming IP Core Clocking Guidelines

This section describes the Serial Lite III Streaming IP core clocking architecture and usage models targeting streaming applications.

The Serial Lite III Streaming IP core has two clocking options to support a variety of streaming applications:

- Standard Clocking Mode (SCM):
 - In this clocking mode, there is no PPM difference (mesochronous system) in both source and sink cores for Intel Arria 10, Stratix V, and Arria V devices. The user interface clock and IP core clock are generated from the same clock source in both source and sink cores.
 - For Intel Stratix 10 devices, this clocking mode is the same as advanced clocking mode for source core. For sink core, a user interface clock is required to drive the adaptation module in the core. To design a mesochronous system, Intel recommends to use the same clock source for transceiver input clock in both source and sink cores.
- Advanced Clocking Mode (ACM):
 - In this clocking mode, for source core, user is required to manage any PPM difference between the user interface logic domain and the transceiver clock domain by throttling the data input or use the same clock source for user interface and transceiver clock domains. The IP core does not support any PPM tolerance between the user interface domain and the transceiver clock domain. For sink core, there is no PPM differences because user is expected to use the recovered clock for user interface logic.

The following sections describe the clocking architectures for Intel Stratix 10, Intel Arria 10, Stratix V, and Arria V GZ devices.

6.1. Standard Clocking Mode

6.1.1. Standard Clocking Mode in Serial Lite III Streaming Intel FPGA IP Core (Intel Stratix 10 Devices)

In this mode, you are required to provide a user clock to drive the user interface for both source and sink core, and specify the user clock frequency through the parameter editor. The Intel Quartus Prime software then automatically determines the required transceiver reference clock from the L-Tile/H-Tile/E-Tile Transceiver Native PHY IP core, provide a list of values for selection and generate a reference clock signal. This reference clock connects to a global clock network that generates a core clock for IP core.

Figure below shows the source and sink variant clocking structure for standard clocking mode in Intel Stratix 10 devices.

Figure 16. Standard Clocking Mode Structure in Intel Stratix 10 L-tile/H-tile Transceiver Devices

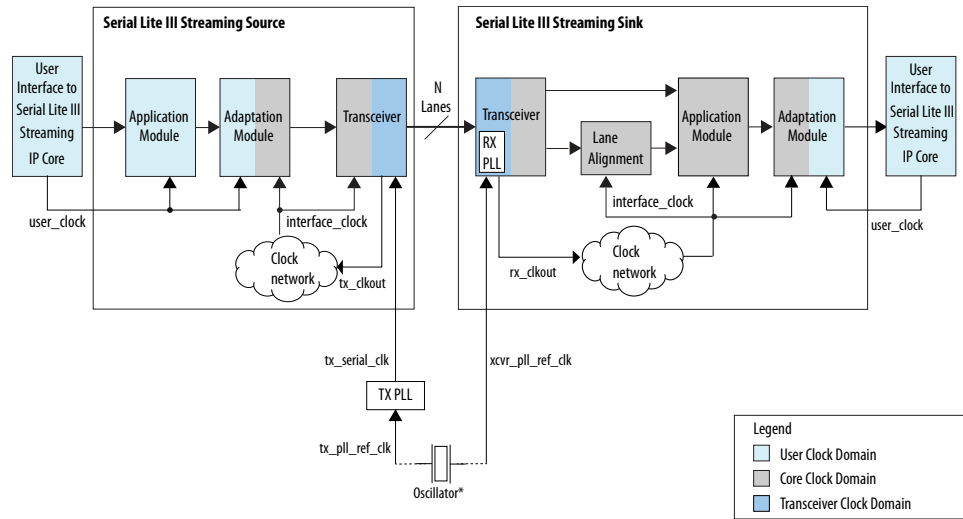

*Intel recommends connecting tx_pll_ref_clk and xcvr_pll_ref_clk to the same oscillator to eliminate PPM differences between source and sink cores.

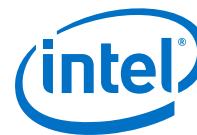

Figure 17. Standard Clocking Mode Structure in Intel Stratix 10 E-tile Transceiver Devices

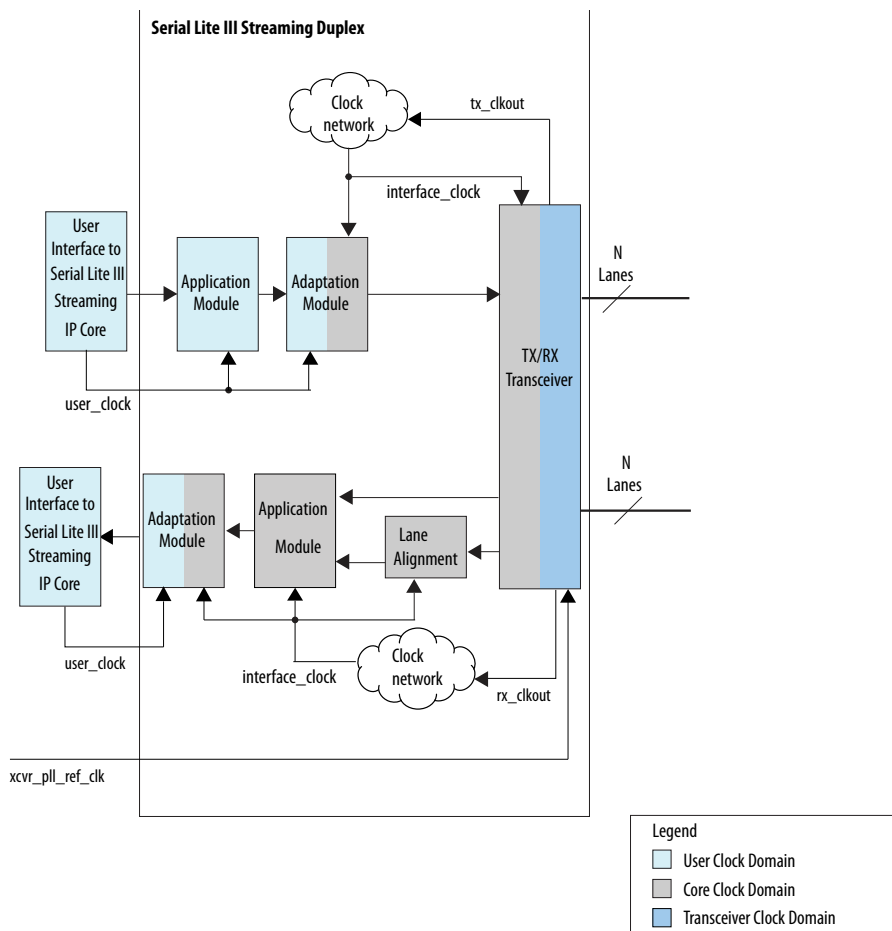
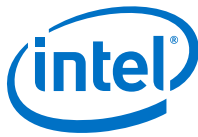

Table 34. Intel Stratix 10 Clocks in Standard Clocking Mode

Clock Name	Description
Source	
user_clock	User-defined. This clock is determined by the required throughput of the user application. For example, if the user interface is 384-bits wide (6 lanes × 64 bit/lane) and the required throughput is 120 Gbps, the user_clock frequency is 312.5 MHz. This is an input clock provided by the user to the IP and should be used to clock the user interface. <i>Note:</i> Use the same clock source as the tx_pll_ref_clk for zero clock PPM implementation.
tx_serial_clk	This clock should toggle at one-half the data rate of the transceiver lane. When you enter the user_clock frequency in the IP parameter editor, the per lane data rate is calculated. Use that value and divided it by two to determine the tx_serial_clk. You are required to instantiate the TX PLL, as shown in the figure above. In the Serial Lite III Streaming design example, an example of the TX PLL (ATX PLL) is generated with the IP core and is configured with the required reference clock and tx_serial_clk. <i>Note:</i> This signal is not available when you select E-Tile as as the transceiver tile.

continued...



Clock Name	Description
tx_clkout	This clock is not exposed to the user. The frequency of tx_clkout is the data rate divided by 64.
interface_clock	This clock is an internal clock and is not exposed to the user. The frequency of this clock is calculated by the IP parameter editor and is the transceiver data rate divided by transceiver PCS-PMA width (64 bits).
Sink	
user_clock	User-defined. This clock is determined by the required throughput of the user application. For example, if the user interface is 384-bits wide (6 lanes × 64 bit/ lane) and the required throughput is 120 Gbps, the user_clock frequency is 312.5 MHz. The frequency of this clock should match the frequency of the user_clock in the Source variant. This is an input clock provided by the user to the IP. This clock should be used to clock the RX user application that drives the RX user interface. <i>Note:</i> Ensure that this clock is operating at equal or higher frequency than interface_clock to avoid data loss.
xcvr_pll_ref_clk	This reference clock is used by the Clock Data Recovery (CDR) unit in the transceiver. It serves as a reference for the CDR to recover the clock from the serial line. The frequency of this clock must match the frequency you select in the IP parameter editor. It should also match the frequency of the tx_pll_ref_clk reference clock for the TX PLL at the Source variant for Intel Stratix 10 L-tile/H-tile transceiver devices.
rx_clkout	This clock is not exposed to the user. The frequency of rx_clkout is the data rate divided by 64.
interface_clock	This clock is an internal clock and is not exposed to the user. The frequency of this clock is calculated by the IP parameter editor and is the transceiver data rate divided by transceiver PCS-PMA width (64 bits).

Example of Implementing Specific User Interface Clock Frequency

An application requires the Serial Lite III Streaming Intel FPGA IP core to sustain data rate of 100 Gbps at the user interface.

$$\text{user_clock (frequency)} \times \text{number_of_lanes} \times 64 \text{ bits/lane} = 100 \text{ Gbps}$$

The data rate for Intel Stratix 10 H-Tile transceivers is limited to 28 Gbps. Therefore, $100 \text{ Gbps} / 28 \text{ Gbps} = 4$ (rounding up)

Choosing 4 lanes gives:

$$\text{user_clock (frequency)} = 100 / (4 \times 64) = 390 \text{ MHz}$$

Choosing 390 MHz as the user_clock, the IP core provides the following values:

Transceiver data rate: 27.456 Gbps

$$\text{tx_clkout: } 27.456 / 64 = 429 \text{ MHz}$$

$$\text{interface_clk: } 27.456 / 64 = 429 \text{ MHz}$$

$$\text{tx_serial_clock: } 27.456 / 2 = 13.728 \text{ MHz}$$

Related Information

- [Source Clock Generator](#) on page 34
- [Serial Lite III Streaming Source Core](#) on page 32
- [Serial Lite III Streaming Sink Core](#) on page 35

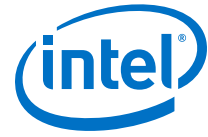

- Sink Clock Generator on page 36
- Intel Stratix 10, Intel Arria 10, Stratix V, and Arria V GZ Variations on page 38

6.1.2. Standard Clocking Mode in Intel Arria 10, Stratix V, and Arria V Devices

The standard clocking mode is an implementation with no PPM differences in IP core. In this mode, you initially specify the user clock frequency through the parameter editor. The Intel Quartus Prime software then automatically determines the required reference clock coming from the Transceiver Native PHY for Intel Arria 10 devices or Interlaken PHY for Stratix V and Arria V devices, and the two clock outputs from the fPLL in the clock generator module.

After the calculation, the Intel Quartus Prime software provides a list of transceiver reference clock values for you to select. It also shows the user clock value in the parameter editor. The Serial Lite III Streaming IP core generates the user clock output for source and sink user interfaces with value identical to the user clock frequency that you specify depending on the clock constraints.

Figures below shows the source and sink variant clocking structure for standard clocking mode in Intel Arria 10 devices.

Figure 18. Standard Clocking Mode Structure for Intel Arria 10 Devices

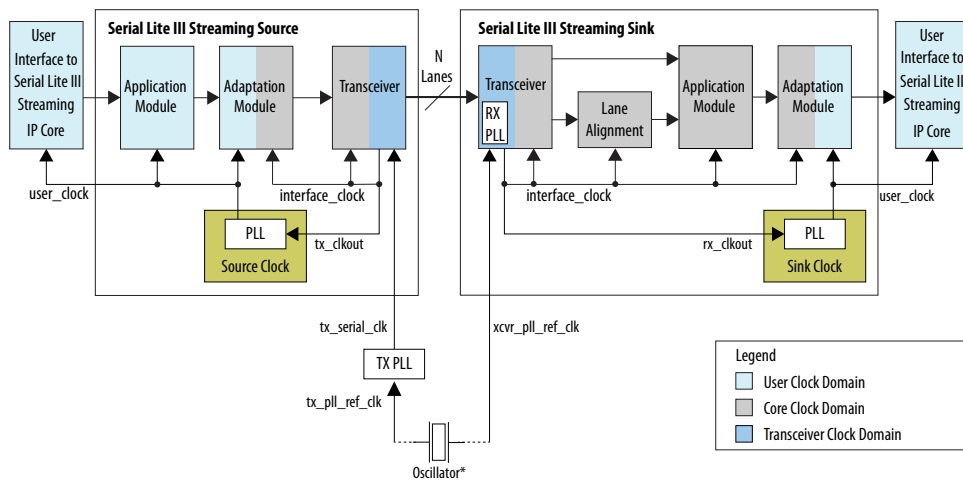

*Intel recommends connecting tx_pll_ref_clk and xcvr_pll_ref_clk to the same oscillator to eliminate PPM differences between source and sink cores.

Figure 19. Standard Clocking Mode Structure for Stratix V or Arria V Devices

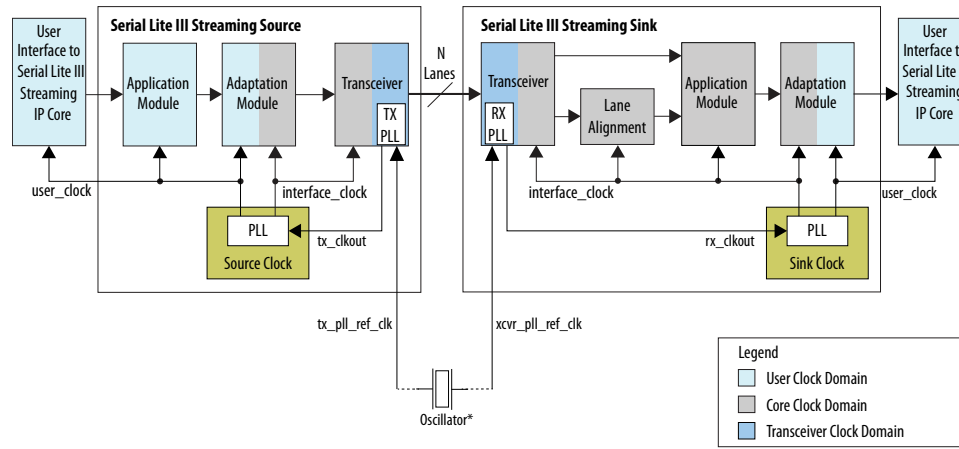

*Intel recommends connecting tx_pll_ref_clk and xcvr_pll_ref_clk to the same oscillator to eliminate PPM differences between source and sink cores.

Table 35. Intel Arria 10, Stratix V, and Arria V Clocks in Standard Clocking Mode

Clock Name	Description
Source	
user_clock	User-defined. This clock is determined by the required throughput of the user application. For example, if the user interface is 384-bits wide (6 lanes × 64 bit/ lane) and the required throughput is 120 Gbps, the user_clock frequency is 312.5 MHz. This is an output clock provided by the IP core to the user. This clock should be used to clock the user interface.
tx_serial_clk (Intel Arria 10 devices)	This clock should toggle at one-half the data rate of the transceiver lane. When you enter the user_clock frequency in the IP parameter editor, the per lane data rate is calculated. Use that value and divided it by two to determine the tx_serial_clk. You are required to instantiate the TX PLL, as shown in the figure above. An example of the TX PLL (ATX PLL) is generated with the IP core and is configured with the required reference clock and tx_serial_clk.
tx_pll_ref_clk (Stratix V and Arria V devices)	This is the reference clock for the transceiver TX PLL. The frequency is selected from the available values in the IP parameter editor and must match that value.
tx_clkout	This clock is not exposed to the user. It is used as a reference clock for the internal PLL. The frequency of tx_clkout is the data rate divided by 64.
interface_clock	This clock is an internal clock and is not exposed to the user. The frequency of this clock is calculated by the IP parameter editor and is the transceiver data rate divided by transceiver PCS-PMA width (64 bits). The internal PLL is configured to generate the required frequency.
Sink	
user_clock	User-defined. This clock is determined by the required throughput of the user application. For example, if the user interface is 384-bits wide (6 lanes × 64 bit/ lane) and the required throughput is 120 Gbps, the user_clock frequency is 312.5 MHz. The frequency of this clock should match the frequency of the user_clock in the Source variant. This is an output clock provided by the IP core to the user. This clock should be used to clock the RX user application that drives the RX user interface.

continued...

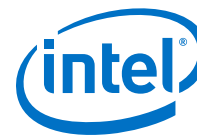

Clock Name	Description
xcvr_pll_ref_clk	This reference clock is used by the Clock Data Recovery (CDR) unit in the transceiver. It serves as a reference for the CDR to recover the clock from the serial line. The frequency of this clock must match the frequency you select in the IP parameter editor. It should also match the frequency of the tx_pll_ref_clk reference clock for the TX PLL at the Source variant.
rx_clkout	This clock is not exposed to the user. It is used as a reference clock for the internal PLL in the Sink. The frequency of rx_clkout is the data rate divided by 64.
interface_clock	This clock is an internal clock and is not exposed to the user. The frequency of this clock is calculated by the IP parameter editor and is the transceiver data rate divided by transceiver PCS-PMA width (64 bits). The internal PLL is configured to generate the required frequency.

Example of Implementing Specific User Interface Clock Frequency

An application requires the Serial Lite III Streaming Intel Arria 10 FPGA IP core to sustain a frequency of 300 Gbps at the user interface.

$$\text{user_clock (frequency)} \times \text{number_of_lanes} \times 64 \text{ bits/lane} = 300 \text{ Gbps}$$

The data rate for Intel Arria 10 GX transceivers is limited to 17.4 Gbps. Therefore, $300 \text{ Gbps} / 17.4 \text{ Gbps} = 18$ (rounding up)

Choosing 18 lanes gives:

$$\text{user_clock (frequency)} = 300 / (18 \times 64) = 260.42 \text{ MHz}$$

A value of 260.40 MHz is out of the supported range for the user_clock frequency. Therefore, you need to add one more lane.

$$\text{user_clock (frequency)} = 300 / (19 \times 64) = 246.71 \text{ MHz}$$

Choosing 246.71 MHz as the user_clock, the IP core provides the following values:

Transceiver data rate: 17.368 Gbps

$$\text{tx_clkout: } 17.368 / 64 = 271.375 \text{ MHz}$$

$$\text{interface_clk: } 17.368 / 64 = 271.375 \text{ MHz}$$

$$\text{tx_serial_clock: } 17.368 / 2 = 8684 \text{ MHz}$$

Related Information

- [Source Clock Generator](#) on page 34
- [Serial Lite III Streaming Source Core](#) on page 32
- [Serial Lite III Streaming Sink Core](#) on page 35
- [Sink Clock Generator](#) on page 36
- [Intel Stratix 10, Intel Arria 10, Stratix V, and Arria V GZ Variations](#) on page 38



6.2. Advanced Clocking Mode

6.2.1. Advanced Clocking Mode Structure for Serial Lite III Streaming Intel FPGA IP Core (Intel Stratix 10 Devices)

In this mode, you must specify the user clock frequency through the Serial Lite III Streaming Intel FPGA IP core parameter editor. Based on the user clock frequency value, the Intel Quartus Prime software automatically calculates the lane rate and core clock.

The parameter editor provides guidance in selecting a source user clock frequency that meets the transceiver data rate constraints. For more information about the lane rate calculation, refer to the “Transmission Overheads and Lane Rate Calculations” section.

The core operates at higher clock rates in Advanced Clocking Mode. Therefore, when operating in this mode, it may be difficult to close timing at higher data rates (for example, 12 to 15 G) or higher number of lanes. You can implement the following qsf assignment when seeing timing recovery violations from sink coreclk reset synchronizer to the sink transfer paths:

```
set_instance_assignment -name GLOBAL_SIGNAL OFF -to  
*seriallite_iii_streaming*clock_gen:sink_clock_gen|dp_sync:coreclk_reset_sync|  
dp_sync_regstage:dp_sync_stage_2*o*
```

The Serial Lite III Streaming Intel FPGA IP core uses the transmit serial clock bus (`tx_serial_clk`) and the `tx_pll_locked` signal to connect the external transmit PLL to the L-Tile/H-Tile Transceiver Native PHY Intel Stratix 10 FPGA IP core.

Note: For sink core, the IP core does not provide any adaptation module and does not support any PPM tolerance between the `interface_clock` and user interface clock. Users should consider a design that can manage the PPM differences between `interface_clock` and user interface clock.

Figure below shows the source and sink variant clocking structure for advanced clocking mode in Intel Stratix 10 devices.

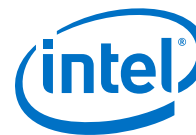
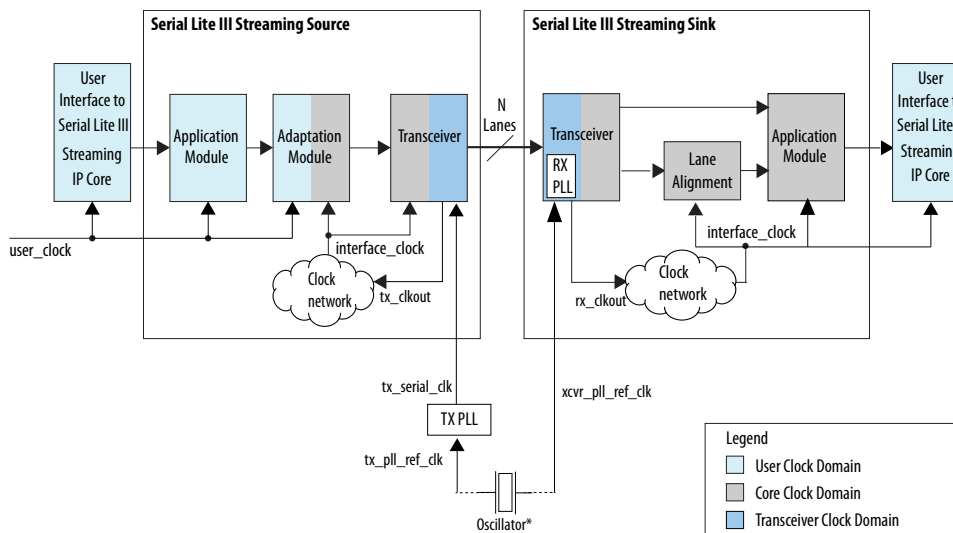

Figure 20. Advanced Clocking Mode Structure for Intel Stratix 10 L-tile/H-tile Transceiver Devices



*Intel recommends connecting tx_pll_ref_clk and xcvr_pll_ref_clk to the same oscillator to eliminate PPM differences between source and sink cores.

Figure 21. Advanced Clocking Mode Structure for Intel Stratix 10 E-tile Transceiver Devices

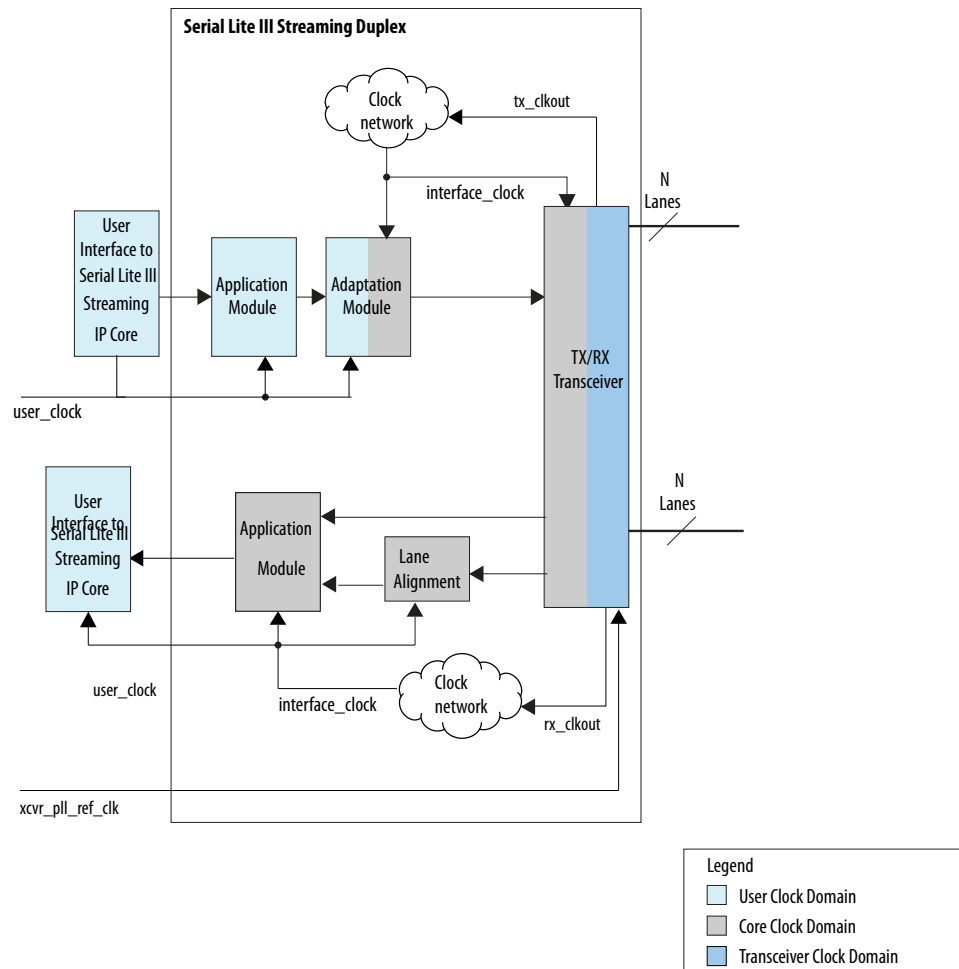

Table 36. Intel Stratix 10 Clocks in Advanced Clocking Mode

Clock Name	Description
Source	
user_clock	User-defined. This clock is determined by the required throughput of the user application. For example, if the user interface is 384-bits wide (6 lanes × 64 bit/ lane) and the required throughput is 120 Gbps, the user_clock frequency is 312.5 MHz. This clock is an input to the IP core and you should toggle this at the specified frequency.
tx_serial_clk	This clock should toggle at one-half the data rate of the transceiver lane. When you enter the user_clock frequency in the IP parameter editor, the per lane data rate is calculated. Use that value and divided it by two to determine the tx_serial_clk. You are required to instantiate the TX PLL. In the Serial Lite III Streaming design example, an example of the TX PLL (ATX PLL) is generated with the IP core and is configured with the required reference clock and tx_serial_clk. <i>Note:</i> This signal is not available when you select E-Tile as the transceiver tile.
<i>continued...</i>	



Clock Name	Description
tx_clkout	This clock is not exposed to the user. The frequency of tx_clkout is the data rate divided by 64.
interface_clock	This is an internal clock and it is not exposed to the user. The frequency of this clock is derived from the transceiver data rate. The frequency is lane data rate divided by 64.
Sink	
xcvr_pll_ref_clk	This reference clock is used by the CDR unit in the transceiver. It serves as a reference for the CDR to be able to recover the clock from the serial line. The frequency of this clock must match the frequency you select in the IP parameter editor. It should also match the frequency of the tx_pll_ref_clk reference clock for the TX PLL at the Sink variant for Intel Stratix 10 L-tile/H-tile transceiver devices.
rx_clkout	This clock is not exposed to the user. The frequency of rx_clkout is the data rate divided by 64.
interface_clock	This clock is derived from the transceiver data. It is lane data rate divided by 64.

Related Information

- [Source Clock Generator](#) on page 34
- [Serial Lite III Streaming Source Core](#) on page 32
- [Serial Lite III Streaming Sink Core](#) on page 35
- [Sink Clock Generator](#) on page 36
- [Intel Stratix 10, Intel Arria 10, Stratix V, and Arria V GZ Variations](#) on page 38

6.2.2. Advanced Clocking Mode Structure For Intel Arria 10, Stratix V, and Arria V Devices

Advanced clocking mode provides users the option to have different user interface clock frequency than the PHY core clock. Hence, there is PPM differences in this clocking mode. You must specify the user clock frequency through the Serial Lite III Streaming FPGA IP core parameter editor. Based on the user clock frequency value, the Intel Quartus Prime software automatically calculates the lane rate and core clock.

The parameter editor provides guidance in selecting a source user clock frequency that meets the transceiver data rate constraints. For more information about the lane rate calculation, refer to the "Transmission Overheads and Lane Rate Calculations" section.

The core operates at higher clock rates in Advanced Clocking Mode. Therefore, when operating in this mode, it may be difficult to close timing at higher data rates (for example, 12 to 15 G) or higher number of lanes. You can implement the following qsf assignment when seeing timing recovery violations from sink coreclk_in reset synchronizer to the sink transfer paths:

```
set_instance_assignment -name GLOBAL_SIGNAL OFF -to
*seriallite_iii_streaming*clock_gen:sink_clock_gen|dp_sync:coreclk_in_reset_sync|
dp_sync_regstage:dp_sync_stage_2*o*
```

The Serial Lite III Streaming Intel Arria 10 FPGA IP core uses the transmit serial clock bus (tx_serial_clk) and the tx_pll_locked signal to connect the external transmit PLL to the Transceiver Native PHY Intel Arria 10/Intel Cyclone 10 GX FPGA IP core.

Note: For sink core, the IP core does not provide any adaptation module. Users should consider a design that can manage the PPM differences between `interface_clock` and user interface clock.

Figure 22. Advanced Clocking Mode Structure for Intel Arria 10 Devices

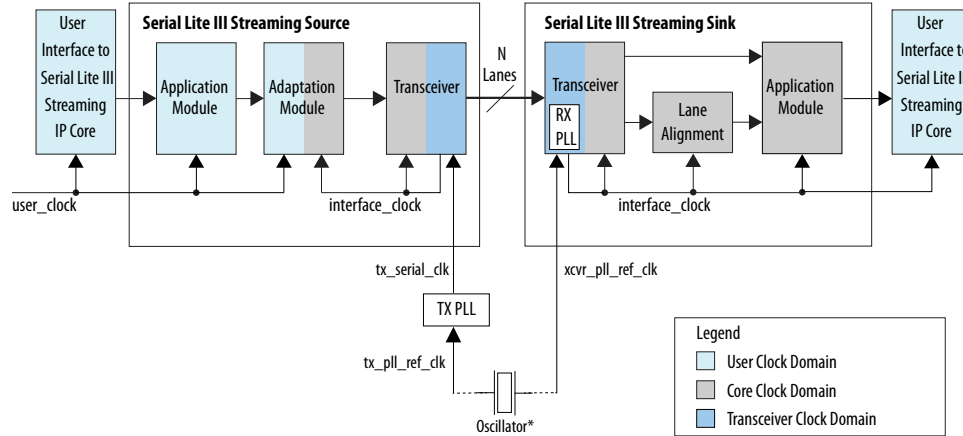

*Intel recommends connecting `tx_pll_ref_clk` and `xcvr_pll_ref_clk` to the same oscillator to eliminate PPM differences between source and sink cores.

Figure 23. Advanced Clocking Mode Structure for Stratix V or Arria V Devices

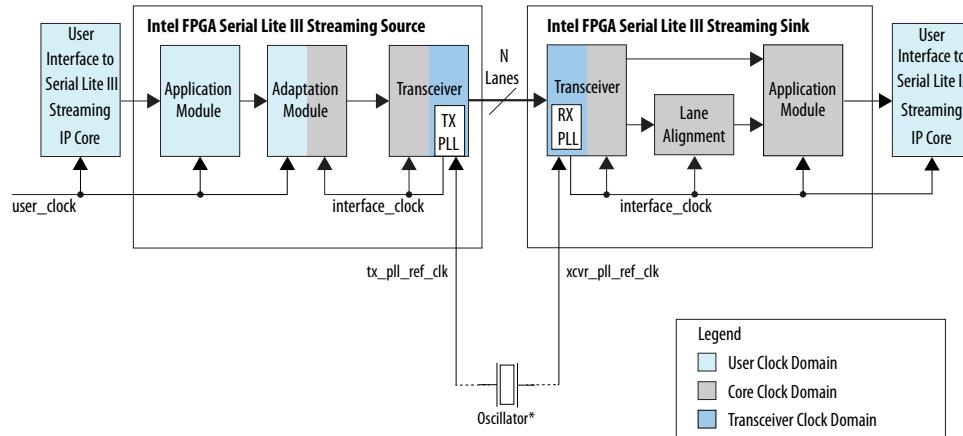

*Intel recommends connecting `tx_pll_ref_clk` and `xcvr_pll_ref_clk` to the same oscillator to eliminate PPM differences between source and sink cores.

Table 37. Intel Arria 10, Stratix V, and Arria V Clocks in Advanced Clocking Mode

Clock Name	Description
Source	
<code>user_clock</code>	User-defined. This clock is determined by the required throughput of the user application. For example, if the user interface is 384-bits wide (6 lanes × 64 bit/ lane) and the required throughput is 120 Gbps, the <code>user_clock</code> frequency is 312.5 MHz. This clock is an input to the IP core and you should toggle this at the specified frequency.
<code>tx_serial_clk</code> (Intel Arria 10 devices)	This clock should toggle at one-half the data rate of the transceiver lane. When you enter the <code>user_clock</code> frequency in the IP parameter editor, the per lane data rate is calculated. Use that value and divided it by two to determine the
<i>continued...</i>	



Clock Name	Description
	tx_serial_clk. You are required to instantiate the TX PLL. An example of the TX PLL (ATX PLL) is generated with the IP core and is configured with the required reference clock and tx_serial_clk frequencies.
interface_clock (Stratix V and Arria V devices)	This is an internal clock and it is not exposed to the user. The frequency of this clock is derived from the transceiver data rate. It is lane data rate divided by 40.
interface_clock	This is an internal clock and it is not exposed to the user. The frequency of this clock is derived from the transceiver data rate. The frequency is lane data rate divided by 64.
Sink	
xcvr_pll_ref_clk	This reference clock is used by the CDR unit in the transceiver. It serves as a reference for the CDR to be able to recover the clock from the serial line. The frequency of this clock must match the frequency you select in the IP parameter editor. It should also match the frequency of the tx_pll_ref_clk reference clock for the TX PLL at the Source variant.
interface_clock	This clock is derived from the transceiver data. It is lane data rate divided by 64. It is an output of the IP core and should be used to clock the RX user application,

Example of Implementing Specific User Interface Clock Frequency

An application requires the Serial Lite III Streaming IP core to sustain a frequency of 240 Gbps at the user interface.

$$\text{user_clock (frequency)} \times \text{number_of_lanes} \times 64 \text{ bits/lane} = 240 \text{ Gbps}$$

The data rate for Intel Arria 10 GX transceivers is limited to 17.4 Gbps. Therefore, $240 \text{ Gbps} / 17.4 \text{ Gbps} = 14$ (rounding up)

Choosing 14 lanes gives:

$$\text{user_clock (frequency)} = 240 / (14 \times 64) = 267.86 \text{ MHz}$$

A value of 267.86 MHz is out of the supported range for the user_clock frequency. Therefore, you need to add one more lane.

$$\text{user_clock (frequency)} = 240 / (15 \times 64) = 250 \text{ MHz}$$

Choosing 250 MHz as the user_clock, the IP core provides the following values:

Transceiver data rate: 16.78 Gbps

interface_clk: $16.78 / 64 = 262.18 \text{ MHz}$

tx_serial_clock: $16.78 \text{ Gbps} / 2 = 8390 \text{ MHz}$

Related Information

- [Source Clock Generator](#) on page 34
- [Serial Lite III Streaming Source Core](#) on page 32
- [Serial Lite III Streaming Sink Core](#) on page 35
- [Sink Clock Generator](#) on page 36
- [Intel Stratix 10, Intel Arria 10, Stratix V, and Arria V GZ Variations](#) on page 38

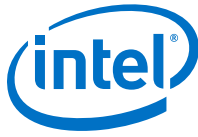

6.3. Standard Clocking Mode vs Advanced Clocking Mode

Table below lists the comparison between two clocking modes that the Serial Lite III Streaming Intel FPGA IP core supports.

Table 38. Clocking Mode Comparisons

Attribute	Standard Clocking Mode		Advanced Clocking Mode	
	Intel Stratix 10	Intel Arria 10, Stratix V, and Arria V GZ	Intel Stratix 10	Intel Arria 10, Stratix V, and Arria V GZ
User clock sourcing	Generated by the user, provided as an input to the Serial Lite III Streaming Intel FPGA IP core.	The user interface clock is generated by the Serial Lite III Streaming Intel FPGA IP core, provided as an output to the user.	For source core, the user interface clock is generated by the user. For sink core, The interface clock is generated by the Serial Lite III Streaming Intel FPGA IP core, provided as an output to the user. This mode is supported to provide backward compatibility when migrating the IP core from previous devices.	Generated by the user, provided as an input to the Serial Lite III Streaming Intel FPGA IP core.
PPM differences between user interface clock and PHY core clock	Yes Intel recommends to use the same clock source as the <code>tx_pll_ref_clk</code> for zero clock PPM implementation.	No	Yes	Yes
fPLL usage <i>Note:</i> The fPLLs are located in the FPGA core fabric	Not used in either simplex or duplex cores.	Simplex: 1 per Source core and 1 per Sink core per Serial Lite III Streaming Intel FPGA IP core instance. Duplex: 2 per Serial Lite III Streaming Intel FPGA IP core instance. (Lane number does not factor in the use of fPLLs. Only the Serial Lite III Streaming Intel FPGA IP core instances are factored in.)	Not used in either simplex or duplex cores.	Not used in either simplex or duplex cores.
Transmission overhead	1.1	1.1	Interlaken overheads	Interlaken overheads

Related Information

[Transmission Overheads and Lane Rate Calculations](#) on page 39



6.4. Clocking Implementation Guidelines

Synchronous Systems

In this scenario, both the Source User Clock and Sink FIFO read clock frequencies are the same. As shown in the figure below, the FIFO read clock is derived from the same crystal oscillator as the Source User Clock. If the Source User Clock requires a PLL, the Sink User Clock should have a PLL with the same configuration.

Figure 24. Same Source and Sink User Clock Frequencies from Same Crystal Oscillator for Intel Stratix 10 L-tile/H-tile Transceiver Devices

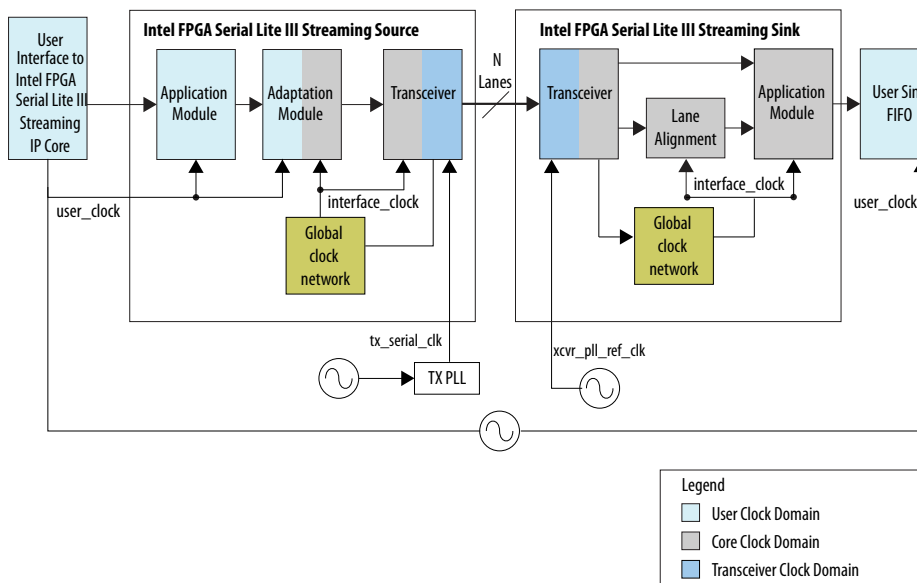
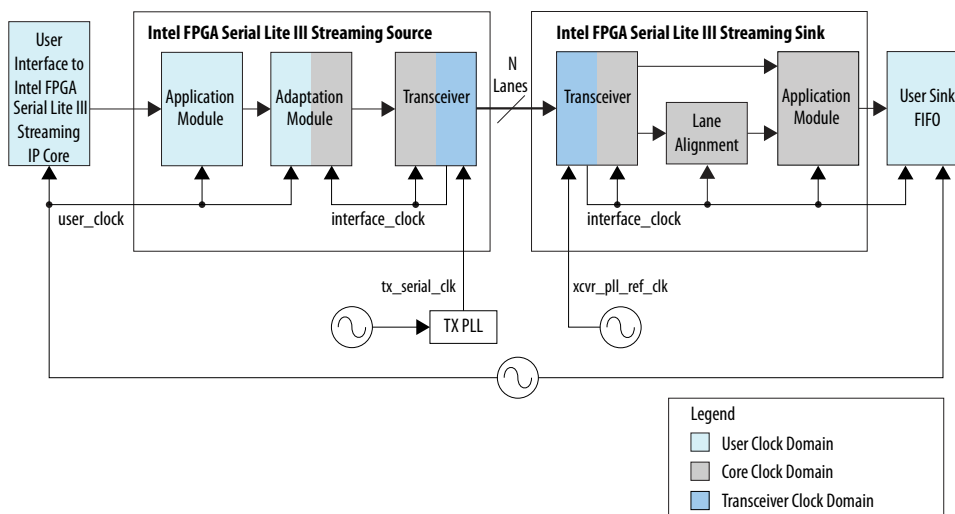

Figure 25. Same Source and Sink User Clock Frequencies from Same Crystal Oscillator for Intel Arria 10, Stratix V and Arria V GZ Devices



Asynchronous Systems

In an asynchronous system, the sink FIFO read clock is derived from a different crystal oscillator, but has the same frequency as the Source User Clock. In this scenario, a PPM difference exists between the Source User Clock and the FIFO read clock. The Source input data rate needs to be reduced to avoid overflowing the Sink FIFO buffer due to the PPM differences. One recommended way is to insert empty cycles in the Source input data stream at Source User Data Interface to reduce the data rate. The Source Application and Adaptation modules absorb these empty data cycles, convert them to idle cells, and insert them into link data stream. These cells are automatically removed at the sink interface and converted back into empty cycles on the sink user interface.

Note: You have to take into consideration the PPM difference and insert enough empty cycles to offset the PPM difference for the worst case scenario.

Figure 26. Same Source and Sink User Frequencies with Different Crystal Oscillators for Intel Stratix 10 L-tile/H-tile Transceiver Devices

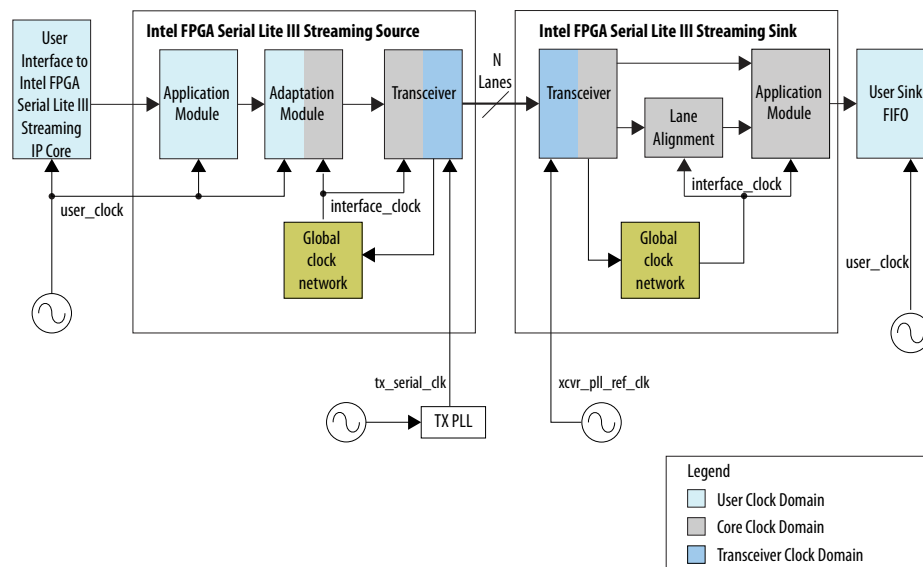

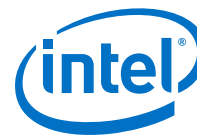
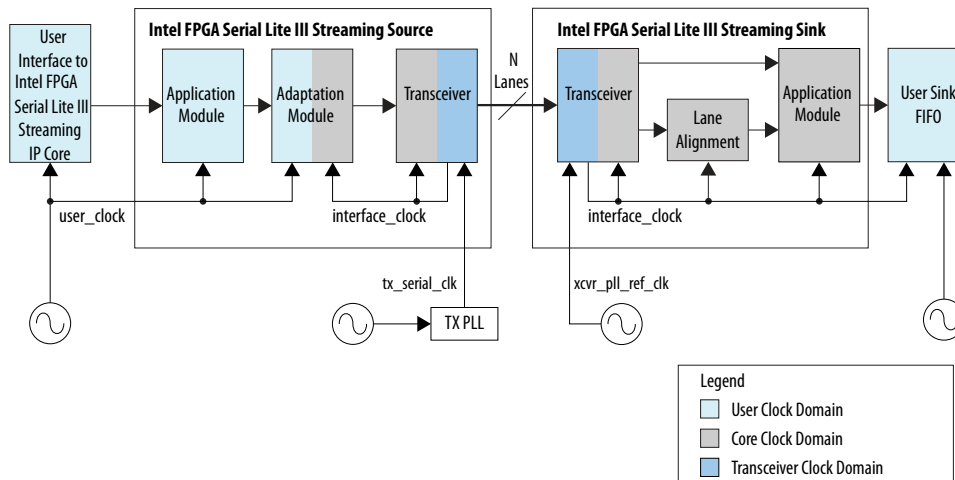

Figure 27. Same Source and Sink User Frequencies, with Different Crystal Oscillators for Intel Arria 10, Stratix V and Arria V GZ Devices

Figure illustrates how two crystal oscillators are used to provide the Source User Clock and the Sink FIFO read clock.



Related Information

[SCFIFO and the DCFIFO IP Cores User Guide](#)

For more information on how to add a sink FIFO buffer.

6.4.1. Choosing TX PLL Type

These are the guidelines for choosing the appropriate type of TX PLL.

Intel Stratix 10 and Intel Arria 10 Devices

Table 39. Intel Stratix 10 L-tile/H-tile Transceiver PLL Data Rate Performance

For Intel Quartus Prime Pro Edition, configure the ATX PLL and fPLL parameter VCCR_GXB and VCCT_GXB supply voltage for the Transceiver to 1.1V and re-generate the IP cores when using data rate more than 15 Gbps.

Number of Lanes	10.3125 G	12.5 G	17.4 G	28 G
1 – 6	x1 – ATX/fPLL/CMU x6/xN – ATX/fPLL	x1/x6/xN – ATX/fPLL	x1/x6/xN – ATX	x1/x4 – ATX
7 – 24	x1 – ATX/fPLL/CMU if using multiple PLLs x6/xN – ATX/fPLL if using 1 or multiple PLLs	x1/x6/xN – ATX/fPLL if using 1 or multiple PLLs	x1/x6/xN – ATX if using multiple PLLs (use multiple PLLs as xN with 1.12 V can only support up to 16 G)	Not supported in Serial Lite III Streaming IP core.



Table 40. Intel Arria 10 PLL Data Rate Performance

Number of Lanes	10.3125 G	12.5 G	17.4 G
1 – 6	x1 – ATX/fPLL/CMU	x1/x6/xN – ATX/fPLL	x1/x6/xN – ATX
	x6/xN – ATX/fPLL		
7 – 24	x1 – ATX/fPLL/CMU if using multiple PLLs	x1/x6/xN – ATX/fPLL if using 1 or multiple PLLs	x1/x6/xN – ATX if using multiple PLLs (use multiple PLLs as xN with 1.12 V can only support up to 16 G)
	x6/xN – ATX/fPLL if using 1 or multiple PLLs		

For ATX PLL VCO frequencies between 7.2 GHz and 11.4 GHz, when two ATX PLLs operate at the same VCO frequency (within 100 MHz), place the ATX PLLs with the gap of seven ATX PLLs apart (skip 6). For ATX PLL VCO frequencies between 11.4 GHz and 14.4 GHz, when two ATX PLLs operate at the same VCO frequency (within 100 MHz), place the ATX PLLs with the gap of four ATX PLLs apart (skip 3). If these spacing rules are violated, the Intel Quartus Prime issues a critical warning. The maximum channel span of a xN clock network is two transceiver banks above and two transceiver banks below the bank that contains the driving PLL and the master CGB. You can use a maximum of 30 channels in a single-bonded or non-bonded xN group. The maximum data rate supported by the xN clock network while driving channels in either the bonded or non-bonded mode depends on the voltage used to drive the transceiver banks and the transceiver speed grade.

Stratix V and Arria V Devices

The Serial Lite III Streaming Intel FPGA IP core in Stratix V and Arria V devices allow a selection of PLL type for use inside the transmit and receive PMA blocks. The IP parameter editor in Intel Quartus Prime Standard Edition allows you to select either a CMU PLL or an ATX PLL. The CMU PLL is more suitable for lower lane data rates, while the ATX PLL is better for higher lane data rates. The supported data rates for the CMU PLL and ATX PLL are provided in Tables 1 (Stratix V) and 2 (Arria V GZ). These tables list the maximum lane data rates per transceiver speed grade. For example, if your design requires a 14.1 Gbps lane rate, you need to use an ATX PLL and select a Transceiver Speed Grade 1 device.

Table 41. Stratix V CMU and ATX PLL Supported Data Rates

For more information about the Stratix V devices, refer to the device data sheet.

Symbol/Description	Conditions	Transceiver Speed Grade 1 (Mbps)			Transceiver Speed Grade 2 (Mbps)			Transceiver Speed Grade 3 (Mbps)		
		Min	Typ	Max	Min	Typ	Max	Min	Typ	Max
CMU PLL Supported Data Range	–	600	–	12500	600	–	12500	600	–	8500
ATX PLL Supported Data Range	VCO Post-divider L=2	8000	–	14100	8000	–	12500	8000	–	8500
	L=4	4000	–	7050	4000	–	6600	4000	–	6600
	L=8	2000	–	3525	2000	–	3300	2000	–	3300

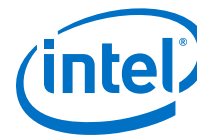

Table 42. Arria V GZ CMU and ATX PLL Supported Data Rates

For more information about the Arria V GZ devices, refer to the device data sheet.

Symbol/ Description	Conditions	Transceiver Speed Grade 2 (Mbps)			Transceiver Speed Grade 3 (Mbps)		
		Min	Typ	Max	Min	Typ	Max
CMU PLL Supported Data Range	_	600	_	12500	600	_	10312.5
ATX PLL Supported Data Range	VCO Post-divider L=2	8000	_	12500	8000	_	10312.5
	L=4	4000	_	6600	4000	_	6600
	L=8	2000	_	3300	2000	_	3300

Related Information

- [Intel Stratix 10 L- and H-Tile Transceiver PHY User Guide - Dynamic Reconfiguration Parameters](#)
- [Intel Stratix 10 E-Tile Transceiver PHY User Guide](#)
For more information about the Intel Stratix 10 E-Tile Native PHY IP core.
- [V-Series Transceiver PHY User Guide](#)
- [Stratix V Device Datasheet](#)
- [Arria V GZ Device Datasheet](#)
- [Intel Arria 10 Device Datasheet Guide](#)
- [Intel Stratix 10 Device Datasheet Guide](#)
- [Intel Arria 10 Transceiver PHY User Guide](#)
For more information about the PLL types in Intel Arria 10 Transceiver PHY
- [Intel Stratix 10 E-Tile Transceiver PHY User Guide](#)
For more information about the Intel Stratix 10 E-Tile Native PHY IP core.

6.5. Core Latency

The table below lists the latency measurement for the Serial Lite III Streaming IP duplex core in standard and advanced clocking mode. An average value is taken from a set of samples during hardware testing. You may see different latency values in simulation.

For a loopback scenario, the core latency measurement is based on the round trip latency from the TX core input to RX core output.

Table 43. Latency Measurement for Duplex Core

Device	Clocking Mode	Parameters		Latency (ns)
		Number of Lanes	Per-Lane Data Rate (Mbps)	
Intel Stratix 10 E-tile Transceiver	Standard	4	28,000	260.000
	Advanced	4	28,000	241.000
	Standard	6	12,500	574.464
				<i>continued...</i>



Device	Clocking Mode	Parameters		Latency (ns)
		Number of Lanes	Per-Lane Data Rate (Mbps)	
	Advanced	6	12,500	533.573
Intel Stratix 10 L-tile/H-tile Transceiver	Standard	4	28,000 ⁽⁸⁾	143.000
	Advanced	4	28,000 ⁽⁸⁾	117.000
	Standard	6	12,500	304.128
	Advanced	6	12,500	272.810
Intel Arria 10	Standard	5	17,400	174.064
	Advanced	5	17,400	154.996
Stratix V, Arria V GZ	Standard	5	10,312.50	320.964
	Advanced	5	10,312.50	292.712

(8) Available only for Intel Stratix 10 H-tile transceivers.

7. Serial Lite III Streaming IP Core Configuration and Status Registers

7.1. Register Map

Table 44. Register Map for Serial Lite III Streaming MAC

Word Address	Register Name
Source Registers	
0x0080	TX Indirect Address
0x0081	TX MAC Status
0x0090	TX Error Status
0x0091	TX Error Interrupt Enable
Sink Registers	
0x00C0	RX Indirect Address
0x00C1	RX MAC Status
0x00c2	RX MAC Control
0x00D0	RX Error Status
0x00D1	RX Error Interrupt Enable

7.2. Configuration and Status Registers

Table 45. Source Configuration and Status Registers for MAC

Use the following definition for register access shown in the table:

- W1C = Write 1 to clear.
- RW = Read Write.

Word Address	Bits	Register Name	Description	Access	Default Value
TX MAC Status					
0x0081	7:4	TXA_reentry_buffer	This field indicates the number of lane alignment re-entry.	RO	0x00
	1	TXA_POSTFRAME_WAIT_entered	This bit indicates the core is in TXA_POSTFRAME_WAIT state and only be cleared when the state machine enters IDLE state or reset.	RO	0x0
	0	TXA_FILL_entered	This bit indicates the alignment state machine enters TXA_FILL state and only be cleared when the state machine enters IDLE state or reset.	RO	0x0
<i>continued...</i>					

Intel Corporation. All rights reserved. Agilix, Altera, Arria, Cyclone, Enpirion, Intel, the Intel logo, MAX, Nios, Quartus and Stratix words and logos are trademarks of Intel Corporation or its subsidiaries in the U.S. and/or other countries. Intel warrants performance of its FPGA and semiconductor products to current specifications in accordance with Intel's standard warranty, but reserves the right to make changes to any products and services at any time without notice. Intel assumes no responsibility or liability arising out of the application or use of any information, product, or service described herein except as expressly agreed to in writing by Intel. Intel customers are advised to obtain the latest version of device specifications before relying on any published information and before placing orders for products or services.

*Other names and brands may be claimed as the property of others.

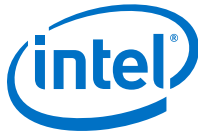

Word Address	Bits	Register Name	Description	Access	Default Value
TX Error Status Register					
0x0090	6	tx_burst_gap_err	TX burst gap error. This bit is set when the gap between two consecutive bursts (or packets) on TX user data interface is less than the required BURST_GAP (a synthesis option). When this error happens, make sure the user interface behavior and BURST_GAP are matching.	W1C	0x0
	5	ecc_err_fatal	TX ECC Error Fatal consolidated status (of all lanes). This bit is set when double bit error is detected and uncorrected.	W1C	0x0
	4	ecc_err_corrected	TX ECC Error Corrected consolidated status (of all lanes). This bit is set when single bit error is detected and corrected.	W1C	0x0
	3	adapt_fifo_overflow	TX MAC Adaptation FIFO overflow consolidated status (of all lanes). In normal condition with all clocks running correctly, this bit is set when the user data rate is faster than expected. When this happens, stop further data transfer and check if the clocks are set correctly.	W1C	0x0
	2	tx_sync_done_lost	TX Lost of Lane Alignment consolidated status (of all lanes).	W1C	0x0
	1	phy_fifo_underflow	TX PHY Phase Compensation FIFO underflow consolidated status (of all lanes). This bit is set when the IP core has major error and requires a full IP core reset.	W1C	0x0
	0	phy_fifo_overflow	TX PHY Phase Compensation FIFO overflow consolidated status (of all lanes). This bit is set when the IP core has major error and requires a full IP core reset.	W1C	0x0
TX Error Interrupt Enable Register					
0x0091	6	tx_burst_gap_err_en	Set this bit to 1 to enable the Burst Gap Error Interrupt.	RW	0x1
	5	ecc_err_fatal_en	Set this bit to 1 to enable the ECC Uncorrected Error Interrupt.	RW	0x0
	4	ecc_err_corrected_en	Set this bit to 1 to enable the ECC Corrected Error Interrupt.	RW	0x0
	3	adapt_fifo_overflow_en	Set this bit to 1 to enable the Adaptation FIFO Overflow Interrupt.	RW	0x1
	2	tx_sync_donelost_en	Set this bit to 1 to enable the Loss of Lane Alignment Interrupt.	RW	0x0
	1	phy_fifo_underflow_en	Set this bit to 1 to enable the PHY FIFO Empty Interrupt.	RW	0x0
	0	phy_fifo_overflow_en	Set this bit to 1 to enable the PHY FIFO Error Interrupt.	RW	0x0

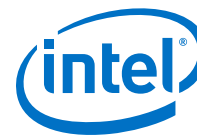
**Table 46. Sink Configuration and Status Registers for MAC**

Use the following definition for register access shown in the table:

- W1C = Write 1 to clear.
- RW = Read Write.

Word Address	Bit	Register Name	Description	Access	Default Value
RX MAC Status					
0x00C1	9	rx_aligned	This bit set when sink core link is aligned successfully.	RO	0x0
	8:2	LASM_misaligned_counter	This field indicates the number of sink alignment retries.	RO	0x00
	1	LASM_DESKEW_entered	This bit is set to indicates sink alignment state machine is in LASM_DESKEW state and is only cleared when the state machine enters IDLE state or reset.	RO	0x00
	0	LASM_FRAME_LOCK_entered	This bit is set to indicates sink alignment state machine is in LASM_FRAME_LOCK state and is only cleared when the state machine enters IDLE state or reset.	RO	0x00
RX MAC Control Register					
0x00C2	0	link_reinit	Set this bit to initiate link re-initialization. When asserted, lane alignment state machine goes to IDLE state and restart the lane alignment process.	RW	0x0
RX Error Status Register					
0x00D0 0	11	rx_data_err	RX Data Error. This bit is set when the MAC receives data to transmit to user logic but ready_rx signal is de-asserted.	W1C	0x0
	10	rx_deskew_fatal	RX Lane Deskew Fatal status (of all lanes). This bit is set, when the lane skews across all lanes have exceeded the hardware de-skew capability. This should not happen under normal conditions. When this bit is set, identify the routing of the lanes (e.g. RX PHY-> board routing -> TX PHY) where large skews are introduced.	W1C	0x0
	9	ecc_err_fatal	RX ECC Error Fatal consolidated status (of all lanes). This bit is set when double bit error detected and uncorrected.	W1C	0x0
	8	ecc_err_corrected	RX ECC Error Corrected consolidated status (of all lanes). This bit is set when single bit error is detected and corrected.	W1C	0x0
	7	adapt_fifo_overflow	RX Adaptation FIFO Overflow This bit is set when user data rate is slower than expected. When this bit is set, stop all data transfer. Verify clocks are set correctly, or verify if ready_rx signal is asserted correctly.	W1C	0x0
<i>continued...</i>					



Word Address	Bit	Register Name	Description	Access	Default Value
	6	rx_alignment_lostlock	RX Lane Alignment Lost consolidated status (of all lanes). This bit is set when lost of alignment is detected by the MAC. This error happens when the SYNC control words across all lanes do not appear in the same clock cycle and data corruption could have happened since one or more lanes would be out of alignment with others. The RX MAC re-establishes the alignment to recover from this error. However, if the condition still persists, a full IP reset is required.	W1C	0x0
	5	rx_align_retry_fail	RX Lane Alignment Retry Fail consolidated status (of all lanes). This bit is set to indicate the number of lane alignment retries has exceeded the expected value.	W1C	0x0
	4	rx_pcs_err	RX PCS Error consolidated status (of all lanes). This bit is set when a synchronization error, metaframe error or crc32 error happens.	W1C	0x0
	3	rx_crc32err	RX CRC error consolidated status (of all lanes) for data integrity monitoring purpose.	W1C	0x0
	2	—	Reserved	—	—
	1	rx_block_lostlock	RX Loss of Block Lock consolidated status (of all lanes). This bit is set when there is a loss of block lock in the receive frame due to signal integrity errors on the serial data stream or when the remote partner is being reset. When this happen, check and remove the cause of loss of block lock to enable the IP core to self-recover to normal state.	W1C	0x0
	0	phy_fifo_overflow	RX PHY Phase Compensation FIFO overflow consolidated status (of all lanes). This bit is set when the IP core has major error and requires a full IP core reset.	W1C	0x0
RX Error Interrupt Enable Register					
0x00D1	11	rx_data_err_int_en	RX Data Error Enable Set this bit to 1 to enable the RX Data Error Enable Interrupt.	RW	0x0
	10	rx_deskew_fatal_int_en	Set this bit to 1 to enable the RX Lane Deskew Fatal Interrupt.	RW	0x0
	9	ecc_err_fatal_int_en	Set this bit to 1 to enable the RX ECC Error Detected and Uncorrected Interrupt.	RW	0x0
	8	ecc_err_corrected_int_en	Set this bit to 1 to enable the RX ECC Error Detected and Corrected Interrupt.	RW	0x0
	7	adapt_fifo_over_flow_int_en	RX Adaptation FIFO Overflow Enable	RW	0x0
<i>continued...</i>					

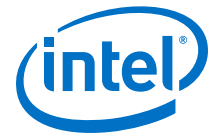

Word Address	Bit	Register Name	Description	Access	Default Value
			Set this bit to 1 to enable the RX Adaptation FIFO Overflow Interrupt.		
	6	rx_alignment_lostlock_int_en	Set this bit to 1 to enable the RX Loss of Lane Alignment Interrupt.	RW	0x0
	5	rx_align_retry_fail_int_en	Set this bit to 1 to enable the RX Lane Alignment Retry Fail Interrupt.	RW	0x0
	4	rx_pcs_err_int_en	Set this bit to 1 to enable the RX PCS Error Interrupt.	RW	0x0
	3	rx_crc32err_int_en	Set this bit to 1 to enable the RX CRC Error Interrupt.	RW	0x0
	2	—	Reserved	—	—
	1	rx_block_lostlock_int_en	Set this bit to 1 to enable the RX Loss of Block Lock Interrupt.	RW	0x0
	0	phy_fifo_overflow_int_en	Set this bit to 1 to enable the RX PHY FIFO Overflow Interrupt.	RW	0x0

Table 47. Interlaken PHY Registers

Word Addr	Bits	R/W	Register Name	Description
PMA Common Control and Status Registers				
0x022	[<p>-1:0]	RO	pma_tx_pll_is_locked	If <p> is the PLL number, Bit[<p>] indicates that the TX CMU PLL (<p>) is locked to the input reference clock. There is typically one pma_tx_pll_is_locked bit per system.
Reset Control Registers-Automatic Reset Controller				
0x041	[31:0]	RW	reset_ch_bitmask	Reset controller channel bitmask for digital resets. The default value is all 1s. Channel <n> can be reset when bit<n> = 1. Channel <n> cannot be reset when bit<n> = 0. The Interlaken PHY IP requires the use of the embedded reset controller to initiate the correct the reset sequence. A hard reset to phy_mgmt_clk_reset and mgmt_rst_reset is required for Interlaken PHY IP. Intel does not recommend use of a soft reset or the use of these reset register bits for Interlaken PHY IP.
0x042	[1:0]	WO	reset_control (write)	Writing a 1 to bit 0 initiates a TX digital reset using the reset controller module. The reset affects channels enabled in the reset_ch_bitmask. Writing a 1 to bit 1 initiates a RX digital reset of channels enabled in the reset_ch_bitmask.
		RO	reset_status(read)	Reading bit 0 returns the status of the reset controller TX ready bit. Reading bit 1 returns the status of the reset controller RX ready bit.
Reset Controls -Manual Mode				
0x044	-	RW	reset_fine_control	You can use the reset_fine_control register to create your own reset sequence. The reset control module, illustrated in Transceiver PHY Top-Level Modules, performs a standard reset
<i>continued...</i>				

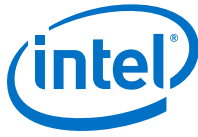

Word Addr	Bits	R/W	Register Name	Description
				<p>sequence at power on and whenever the <code>phy_mgmt_clk_reset</code> is asserted. Bits [31:4, 0] are reserved.</p> <p>The Interlaken PHY IP requires the use of the embedded reset controller to initiate the correct the reset sequence. A hard reset to <code>phy_mgmt_clk_reset</code> and <code>mgmt_rst_reset</code> is required for Interlaken PHY IP.</p> <p>Intel does not recommend use of a soft reset or the use of these reset register bits for Interlaken PHY IP.</p>
	[3]	RW	<code>reset_rx_digital</code>	Writing a 1 causes the RX digital reset signal to be asserted, resetting the RX digital channels enabled in <code>reset_ch_bitmask</code> . You must write a 0 to clear the reset condition.
	[2]	RW	<code>reset_rx_analog</code>	Writing a 1 causes the internal RX digital reset signal to be asserted, resetting the RX analog logic of all channels enabled in <code>reset_ch_bitmask</code> . You must write a 0 to clear the reset condition.
	[1]	RW	<code>reset_tx_digital</code>	Writing a 1 causes the internal TX digital reset signal to be asserted, resetting all channels enabled in <code>reset_ch_bitmask</code> . You must write a 0 to clear the reset condition.
PMA Control and Status Registers				
0x061	[31:0]	RW	<code>phy_serial_loopback</code>	Writing a 1 to channel <code><n></code> puts channel <code><n></code> in tx to rx serial loopback mode. For information about pre- or post-CDR rx to tx serial loopback modes, refer to Loopback Modes.
0x064	[31:0]	RW	<code>pma_rx_set_locktodata</code>	When set, programs the RX CDR PLL to lock to the incoming data. Bit <code><n></code> corresponds to channel <code><n></code> . By default, the Interlaken PHY IP configures the CDR PLL in Auto lock Mode. This bit is part of the CDR PLL Manual Lock Mode which is not the recommended usage.
0x065	[31:0]	RW	<code>pma_rx_set_locktoref</code>	When set, programs the RX CDR PLL to lock to the reference clock. Bit <code><n></code> corresponds to channel <code><n></code> . By default, the Interlaken PHY IP configures the CDR PLL in Auto lock Mode. This bit is part of the CDR PLL Manual Lock Mode which is not the recommended usage.
0x066	[31:0]	RO	<code>pma_rx_is_lockedtodata</code>	When asserted, indicates that the RX CDR PLL is locked to the RX data, and that the RX CDR has changed from LTR to LTD mode. Bit <code><n></code> corresponds to channel <code><n></code> .
00x067	[31:0]	RO	<code>pma_rx_is_lockedtoref</code>	When asserted, indicates that the RX CDR PLL is locked to the reference clock. Bit <code><n></code> corresponds to channel <code><n></code> .
0x080	[31:0]	WO	<code>indirect_addr</code>	Provides for indirect addressing of all PCS control and status registers. Use this register to specify the logical channel address of the PCS channel you want to access.
Device Registers				
	[27]	RO	<code>rx_crc32_err</code>	Asserted by the CRC32 checker to indicate a CRC error in the corresponding RX lane.
<i>continued...</i>				

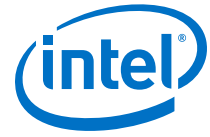

Word Addr	Bits	R/W	Register Name	Description
				From block: CRC32 checker.
0x081	[25]	RO	rx_sync_lock	Asserted by the frame synchronizer to indicate that 4 frame synchronization words have been received so that the RX lane is synchronized. From block: Frame synchronizer.
	[24]	RO	rx_word_lock	Asserted when the first alignment pattern is found. The RX FIFO generates this synchronous signal. From block: The RX FIFO generates this synchronous signal.

For Native PHY IP core configuration and status registers, refer to *Intel Arria 10 Transceiver Register Map, Logical View of the Intel Stratix 10 L-Tile/H-Tile Transceiver Registers*, and *Intel Stratix 10 E-Tile Transceiver PHY User Guide Register Map* in related links.

Related Information

- [Intel Arria 10 Transceiver Register Map](#)
Information on configuration and status registers in Intel Arria 10 transceiver.
- [Logical View of the Intel Stratix 10 L-Tile/H-Tile Transceiver Registers](#)
- [Intel Stratix 10 E-Tile Transceiver Register Map](#)
For more information about the Intel Stratix 10 E-Tile Native PHY registers.

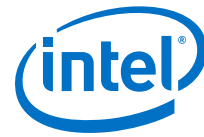

8. Serial Lite III Streaming IP Core Debugging Guidelines

This section includes guidelines to assist you in debugging the IP core link issues.

8.1. Creating a Signal Tap Debug File to Match Your Design Hierarchy

For Intel Arria 10 and Intel Stratix 10 devices, the Intel Quartus Prime software generates two files, `build_stp.tcl` and `<ip_core_name>.xml`. You can use these files to generate a Signal Tap file with probe points matching your design hierarchy.

The Intel Quartus Prime software stores these files in the `<IP core directory>/synth/debug/stp/` directory.

Synthesize your design using the Intel Quartus Prime software.

1. To open the Tcl console, click **View > Utility Windows > Tcl Console**.
2. Type the following command in the Tcl console:
`source <IP core directory>/synth/debug/stp/build_stp.tcl`
3. To generate the STP file, type the following command:
`main -stp_file <output stp file name>.stp -xml_file <input xml_file name>.xml -mode build`
4. To add this Signal Tap file (**.stp**) to your project, select **Project > Add/Remove Files in Project**. Then, compile your design.
5. To program the FPGA, click **Tools > Programmer**.
6. To start the Signal Tap Logic Analyzer, click **Quartus Prime > Tools > Signal Tap Logic Analyzer**.

The software generation script may not assign the Signal Tap acquisition clock in `<output stp file name>.stp`. Consequently, the Intel Quartus Prime software automatically creates a clock pin called `auto_stp_external_clock`. You may need to manually substitute the appropriate clock signal as the Signal Tap sampling clock for each STP instance.

7. Recompile your design.
8. To observe the state of your IP core, click **Run Analysis**.

You may see signals or Signal Tap instances that are red, indicating they are not available in your design. In most cases, you can safely ignore these signals and instances. They are present because software generates wider buses and some instances that your design does not include.

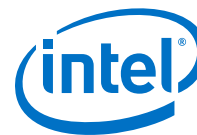

8.2. Serial Lite III Streaming IP Core Link Debugging

The following section describes the link-up sequence that you can use when debugging the Serial Lite III Streaming IP core. The internal signals in the charts and tables can be observed by the Signal Tap.

8.2.1. Source Core Link Debugging

Figure 28. Source Core Link Debugging Flow Chart

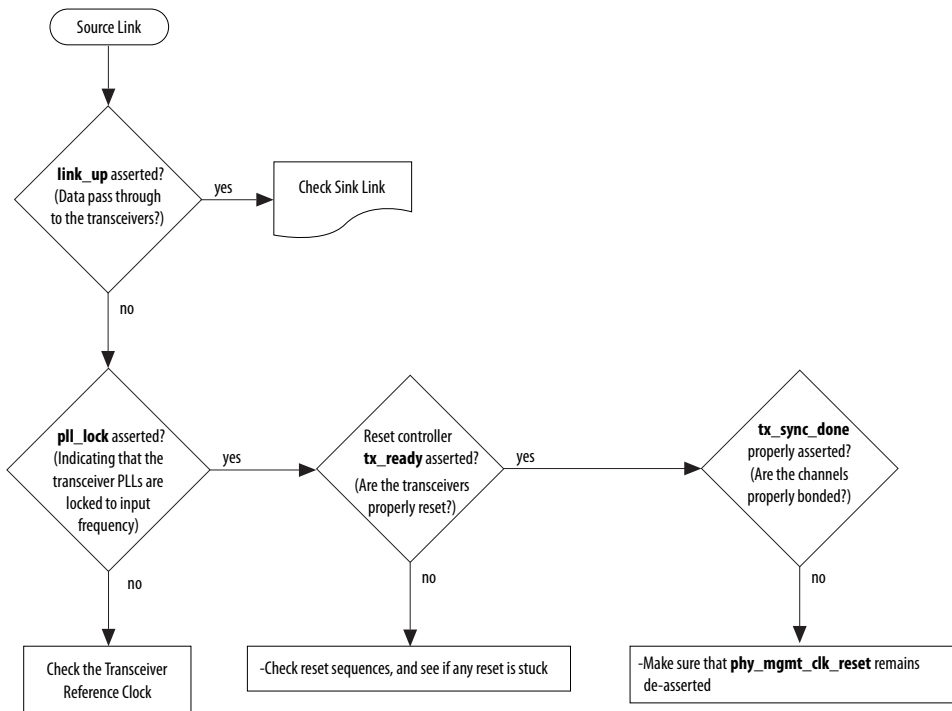

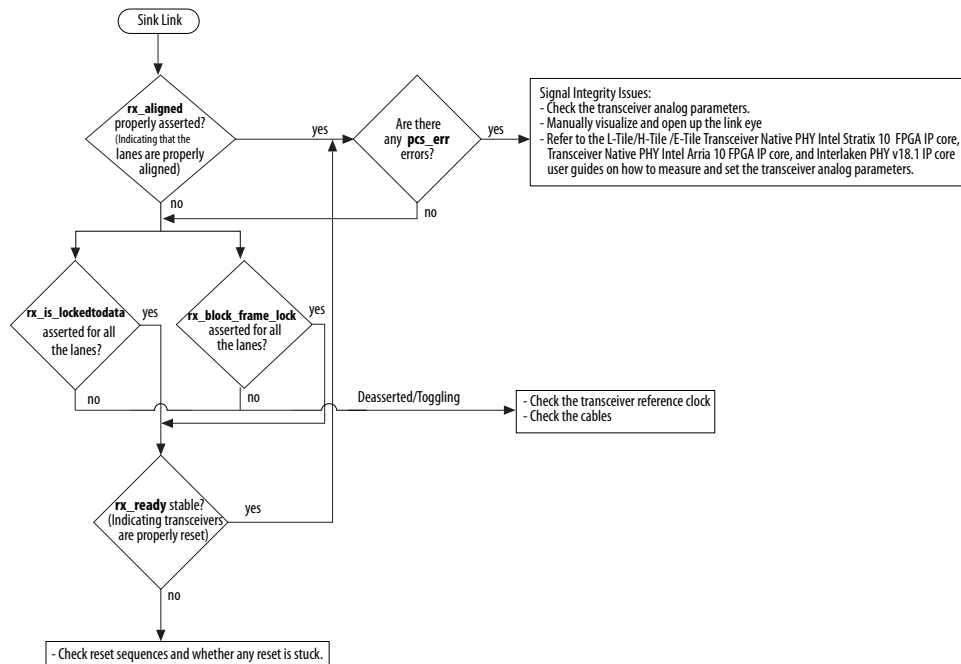

Table 48. Source Link Debugging Signals (Intel Arria 10, Intel Stratix 10, Arria V GZ, and Stratix V devices)

Signal Name	Location (Intel Arria 10, Arria V GZ, and Stratix V)	Location (Intel Stratix 10)	Description
link_up_tx	Top level port	Top level port	The core asserts this signal to indicate that initialization sequence is complete and the core is ready to transmit the data.
tx_pll_locked	Native PHY wrapper port	Top level port	This active high signal indicates that the transceivers are locked to the reference clock.
tx_pcs_ready	Native PHY wrapper port	(Encrypted) Soft PHY port	This active high signal indicates that the reset sequence for the source PCS is complete and is ready to accept data.
tx_sync_done	Native PHY wrapper port	PHY top port	This active high signal indicates that all the lanes are bonded by the Native PHY or Interlaken PHY IP core. This signal should be properly asserted for normal operation. A rapidly toggling signal indicates that the source FIFO is having either too much or too little data, or the core reset is having issues.
tx_cal_busy	/source/ Interlaken_phy_ip_tx / sv_ilk_inst (for Stratix V devices only)	-	Source transceiver calibration status. This active high signal can be used for debugging if the reconfiguration controller is actively calibrating during the initialization sequence.

8.2.2. Sink Core Link Debugging

Figure 29. Sink Core Link Debugging Flow Chart



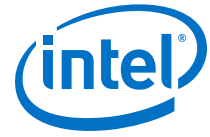

Table 49. Sink Link Debugging Signals (Intel Stratix 10, Intel Arria 10, Stratix V , and Arria V GZ devices)

Signal Name	Location (Intel Arria 10, Stratix V, and Arria V GZ)	Location (Intel Stratix 10)	Description
rx_aligned	Top level port	Top level port	This active high signal indicates that the lanes are properly aligned. This signal should remain asserted for proper operation.
rx_pcs_ready	Native PHY wrapper port	(Encrypted) Soft PHY port	An asserted value for this active high signal indicates that the reset sequence for the sink PCS is complete.
rx_crc32err	Native PHY wrapper port	PHY top internal	This active high signal indicates CRC-32 error from the CRC checker.
rx_pcs_err	_	PHY top port	This active high signal indicates if there is any Sync Header, Meta-frame Length, or CRC32 error. This signal can be used to debug whether there is any data integrity issue on a given meta-frame.
rx_frame_lock [lanes-1:0]	Native PHY wrapper port	PHY top internal	This active high signal indicates that four Interlaken synchronization words are found for a given lane.
rx_block_frame _lock	Native PHY wrapper port	PHY top port	This active high signal indicates whether a link has established both block lock and frame lock link alignment state.
rx_is_lockedto data [lanes-1:0]	Native PHY wrapper internal	PHY top internal	This active high signal indicates that the transceiver channel PLL has locked itself to the incoming data.
rx_cal_busy	Native PHY wrapper internal	PHY top internal	Sink transceiver calibration status. This active high signal can be used for debugging if the reconfiguration controller is actively calibrating during the initialization sequence.



9. Serial Lite III Streaming IP Core User Guide Archives

If an IP core version is not listed, the user guide for the previous IP core version applies.

IP Core Version	User Guide
18.1	SerialLite III Streaming IP Core User Guide
18.0	SerialLite III Streaming IP Core User Guide
17.1	SerialLite III Streaming IP Core User Guide
17.0	SerialLite III Streaming IP Core User Guide
16.1	SerialLite III Streaming IP Core User Guide
16.0	SerialLite III Streaming IP Core User Guide
15.1	SerialLite III Streaming IP Core User Guide
15.0	SerialLite III Streaming IP Core User Guide
14.1	SerialLite III Streaming IP Core User Guide

10. Document Revision History for the Intel FPGA Serial Lite III Streaming IP Core User Guide

Document Version	Intel Quartus Prime Version	Changes
2020.05.05	18.1.1	<ul style="list-style-type: none"> Added Serial Lite III Streaming IP latency values for standard and advanced modes in 28 Gbps transceiver rate. Rebranded the following: <ul style="list-style-type: none"> Avalon-MM interface to Avalon memory-mapped interface Avalon-ST interface to Avalon streaming interface
2019.02.25	18.1.1	Added <i>Intel Stratix 10 E-Tile Transceiver PHY User Guide: PMA Adaptation</i> link in the <i>Parameter Settings for Intel Stratix 10 Devices</i> topic, to provide more information on parameters in the PMA Adaptation tab.
2019.01.17	18.1	Updated <code>phy_mgmt_addr</code> signal description for Intel Stratix 10 device in <i>L-Tile/H-Tile/E-Tile Transceiver Native PHY Intel Stratix 10 IP Core Signals (Interlaken Mode)</i> table.
2018.09.24	18.1	<ul style="list-style-type: none"> Updated resource utilization with E-tile transceiver support. Added <i>Serial Lite III Streaming Intel FPGA IP Transceiver Tiles Support in Intel Stratix 10 Devices</i> table. Added note to clarify parameters that are not supported in E-tile transceiver. Added the following registers in <i>Source Configuration and Status Registers for MAC</i> and <i>Sink Configuration and Status Registers for MAC</i> tables: <ul style="list-style-type: none"> TX MAC Status RX MAC Status Removed the following bits in <i>Sink Configuration and Status Registers for MAC</i> table: <ul style="list-style-type: none"> RX Loss of Frame Lock Consolidated Status bit 2 of RX Error Status Register RX Loss of Frame Lock Interrupt bit 2 of RX Error Interrupt Enable Register Added the following bits in <i>Sink Configuration and Status Registers for MAC</i> table: <ul style="list-style-type: none"> RX Data Error bit 11 of RX Error Status Register RX Adaptation FIFO Overflow bit 7 of RX Error Status Register RX Data Error Enable bit 11 of RX Error Interrupt Enable Register RX Adaptation FIFO Overflow Enable bit 7 of RX Error Interrupt Enable Register Added a note to clarify that Riviera Pro is not supported for E-tile transceiver. Updated <i>Error Detection, Reporting, and Recovering Mechanism</i> topic with reporting and recovering mechanisms. Updated core latency for Intel Stratix 10 E-tile transceiver devices in <i>Latency Measurement for Duplex Core</i> table.

continued...

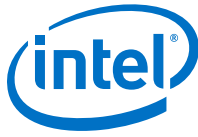

Document Version	Intel Quartus Prime Version	Changes
		<ul style="list-style-type: none"> Added Intel Stratix 10 E-tile transceiver devices standard and advanced clocking mode block diagrams. Updated reset scheme for Intel Stratix 10 E-tile transceiver devices. Added IP core link up sequences with waveforms in <i>Link-Up Sequence</i> topic.
2018.05.07	18.0	<ul style="list-style-type: none"> Updated 28 Gbps with 4 data lanes support for Intel Stratix 10 devices. Updated resources for 28 Gbps with 4 data lanes in <i>SerialLite III Streaming IP Core Performance and Resource Utilization</i> table. Reorganized <i>SerialLite III Streaming IP Core Functional Description</i> and <i>SerialLite III Streaming IP Core Clocking Guidelines</i> chapters. Added <i>SerialLite III Streaming Intel FPGA IP Core Design Examples</i> section.

Date	Version	Changes
December 2017	2017.12.27	<ul style="list-style-type: none"> Updated transceiver data rate from 25 Gbps to 17.4 Gbps for GXT selection in Transceiver Channel Type parameter.
November 2017	2017.11.06	<ul style="list-style-type: none"> Updated parameter settings for Intel Stratix 10, Intel Arria 10, and Stratix V and Arria V GZ devices. Updated transfer data rate supported in Intel Stratix 10 devices. Added performance, transceiver speed grade and resource utilization for 25 and 28 Gbps data rate for Intel Stratix 10 devices. Added a note to specify no support for simplex receiver mode in Intel Stratix 10 devices for data rate greater than 17.4 Gbps.
May 2017	2017.05.08	<ul style="list-style-type: none"> Clarified the device family support for Intel Stratix 10 devices. Clarified the exact replica of output data support for pure streaming operation in the following locations: <ul style="list-style-type: none"> Continuous Mode sub-topic IP Core Architecture topic Comparing Standard and Advanced Clocking Modes table Standard Clocking Mode sub-topic Sink Adaptation Module sub-topic Standard Clocking Mode vs Advanced Clocking Mode topic Removed the Continuous vs. Burst Mode Characteristics table. Updated the SerialLite III Streaming IP Core FPGA Performance and Resource Utilization table for Intel Arria 10, Stratix V GX and Arria V GZ, and Intel Stratix 10 devices. Updated the SerialLite III Streaming IP Core Parameters table: <ul style="list-style-type: none"> Removed the Streaming Mode parameter. Updated the description for User input parameter. Updated the description in the Specifying IP Core Parameters and Options topic. Updated the Simulation Parameters sub-topic to include testbench default simulation parameters for Intel Arria 10 and Intel Stratix 10 devices. Updated the Simulator column in the Intel FPGA IP Core Simulation Scripts table. Updated the Interlaken PHY IP Duplex Core or Native PHY IP Duplex Core - Interlaken Mode topic. Updated the description of the <code>phy_mgmt_clk</code> signal in the SerialLite III Streaming IP Core Clock Domains and Signals table. Updated the SerialLite III Streaming Sink Core topic. Updated the Latency Measurement for Duplex Core table in the Core Latency topic to include Intel Stratix 10 device. Updated the second note in the Reset topic.

continued...

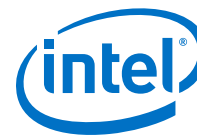

Date	Version	Changes
		<ul style="list-style-type: none"> • Updated the description in the CRC-32 Error Injection topic. • Updated the Clocking Structure for Stratix 10 Devices topic: <ul style="list-style-type: none"> – Added the Source and Sink descriptions for interface_clock signal in the Intel Stratix 10 Clocks in Standard Clocking Mode table. – Added tx_clkout and rx_clkout signals in the Intel Stratix 10 Clocks in Advanced Clocking Mode table. – Updated the description for Choosing TX PLL Type for Intel Stratix 10 Devices sub-topic. • Updated the Clocking Structure For Intel Arria 10 Devices topic: <ul style="list-style-type: none"> – Updated the Clocking Structure for Intel Arria 10 Devices figure. – Updated the Source and Sink descriptions for interface_clock signal in the Intel Arria 10 Clocks in Standard Clocking Mode table. – Updated the description for Choosing TX PLL Type for Intel Arria 10 Devices sub-topic. • Updated the SerialLite III Streaming Link Debugging topic: <ul style="list-style-type: none"> – Updated the Source Core Link Debugging Flow Chart figure. – Updated the Source Link Debugging Signals table to include Intel Stratix 10 support. – Updated the Sink Core Link Debugging Flow Chart figure. – Updated the Sink Link Debugging Signals table to include Intel Stratix 10 support. • Updated the Error Handling topic: <ul style="list-style-type: none"> – Updated the sink core error flag. – Added information on error status on error_rx signal condition. • Updated the Register Map for SerialLite III Streaming MAC table: <ul style="list-style-type: none"> – Added RX Error Status register. – Updated the source register name for 0x0090 from TX Error to TX Error Status. – Removed RX MAC status. • Updated the Configuration and Status Registers topic. • Minor typographical corrections and stylistic changes.
October 2016	2016.10.28	<ul style="list-style-type: none"> • Added information about Intel Stratix 10 support. • Update document template.
May 2016	2016.05.02	<ul style="list-style-type: none"> • Added a new parameter—Enable Transceiver Native PHY ADME • Updated the IP core parameter names. • Added new sections: <ul style="list-style-type: none"> – Serial Lite III Streaming IP Core Clocking Guidelines on page 75 – Creating a Signal Tap Debug File to Match Your Design Hierarchy on page 102 • Revised the core_reset signal description—removed 32-cycle reset restriction. This restriction is removed in IP core version 15.1 onwards but is still applicable to prior versions. • Updated the IP Core release information. • Removed the design example chapter. The information is now located in the <i>Design Examples for SerialLite III Streaming IP Core User Guide</i>.
November 2015	2015.11.02	<ul style="list-style-type: none"> • Updated the IP Core Performance and Resource Utilization table. • Added a new topic—Intel FPGA IP Evaluation Mode Timeout Behavior on page 15 • Added a link to <i>Introduction to Altera IP Cores</i>. • Added a note in "Altera IP Core Simulation Scripts" to recommend that you run the msim_setup.tcl script in the ModelSim-Altera Simulator Tcl console. • Changed the minimum required gap between bursts to one user clock cycle.

continued...



Date	Version	Changes
		<ul style="list-style-type: none">Added information about using I/O PLL to generate the core clock and user clock signals for Arria 10 devices.Added a new parameter—Burst Gap.Updated the parameter description for Interface clock frequency, Core clock frequency, and fPLL reference clock frequency.Updated the parameter value for Core clock frequency.Updated the PMA width for Interlaken mode to 64 bits for Arria 10 devices.Updated all SerialLite III Streaming IP Core block diagrams.Removed the Source PPM Absorption module from the core.Changed the bit function and description for <code>error</code> (source core) and <code>error_tx</code> (duplex core) signals.Updated the description of <code>link_up_rx</code> signal.Added "Interlaken PHY Register Descriptions" table to specify the registers to access using the Avalon-MM PHY management interface.Updated the design example to support Arria 10 devices.Changed the target development kit to Transceiver Signal Integrity Development Kit, Stratix V GX Edition.Updated the design operation names in the Design Example Operation topic.Changed the sink link debug signal from <code>rx_crc32</code> to <code>rx_crc32err</code>.Updated the sink core conditions in the Error Handling topic.Changed instances of <i>Quartus II</i> to <i>Quartus Prime</i>.
May 2015	2015.05.04	<ul style="list-style-type: none">Updated the IP Core Performance and Resource Utilization table.Changed the width of <code>sync_rx</code> and <code>sync_tx</code> signals from 4 to 8 bits in <i>Signals</i>.Added external serial loopback in Testbench and Testbench.
December 2014	2014.12.15	Described Arria 10 support for up to 17.4 Gbps transceiver data rate. Updated core latency numbers. Updated the Transmission Overheads and Lane Rate Calculations on page 39. Minor text changes.
August 2014	2014.08.18	Added information about Arria 10 support.
June 2014	2014.06.30	Replaced references to MegaWizard Plug-In Manager with IP catalog or parameter editor. Minor text changes.
November 2013	2013.11.04	<ul style="list-style-type: none">Added information on CRC-32 error injection.Added information on the FIFO ECC protection option.
May 2013	2013.05.13	Initial release