

MELODY-3-M

~35° medium beam with 3 optics

TECHNICAL SPECIFICATIONS:

Dimensions	Ø 50.6 mm
Height	11.9 mm
Fastening	glue, pin
ROHS compliant	yes ⓘ

MATERIAL SPECIFICATIONS:

Component	Type	Material	Colour	Finish
MELODY-3-M	Multi-lens	PMMA	clear	



ORDERING INFORMATION:

Component	Qty in box	MOQ	MPQ	Box weight (kg)
C13095_MELODY-3-M » Box size: 480 x 280 x 300 mm	364		28	5.7

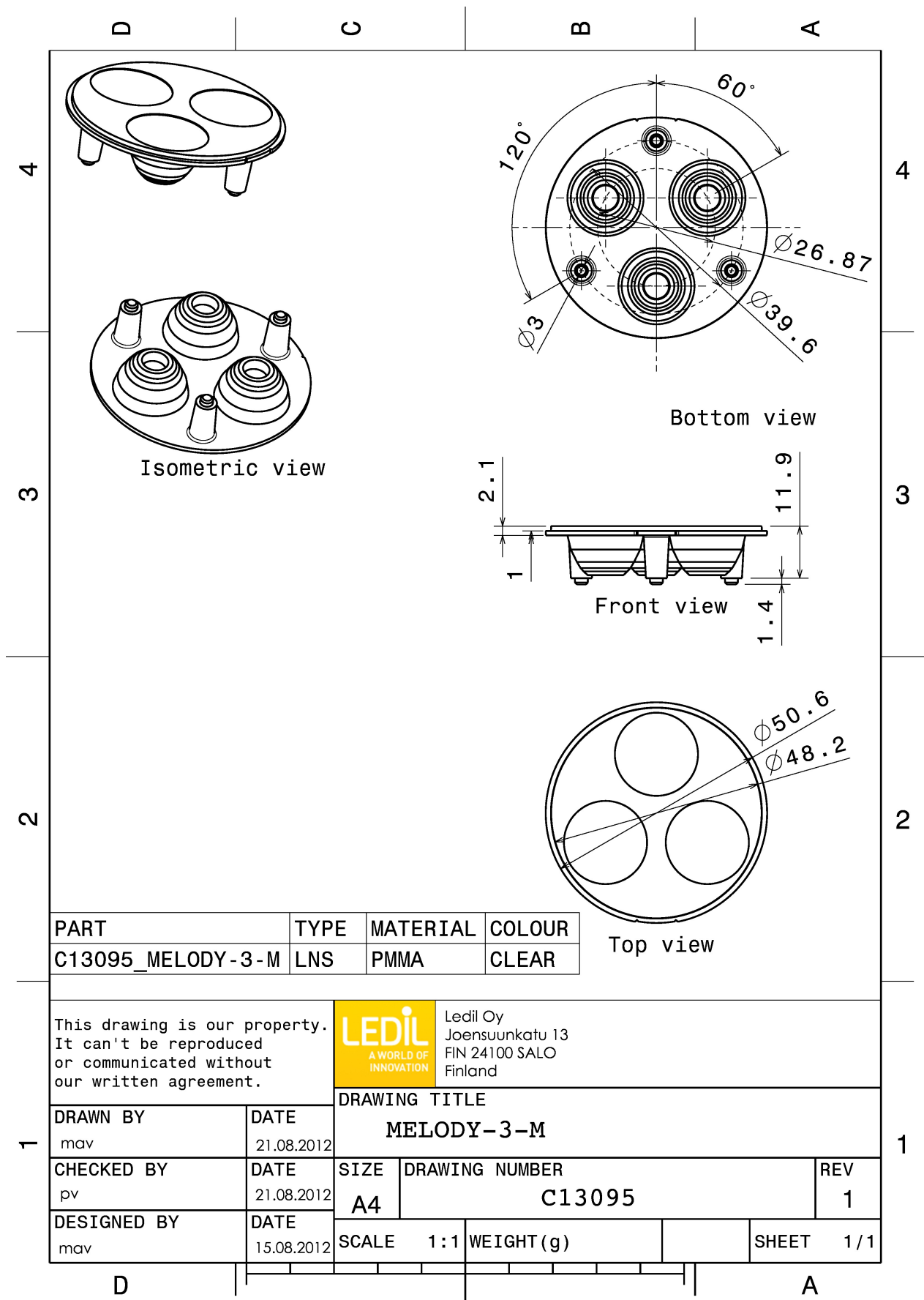

PART	TYPE	MATERIAL	COLOUR
C13095_MELODY-3-M	LNS	PMMA	CLEAR

This drawing is our property. It can't be reproduced or communicated without our written agreement.

LEDiL
A WORLD OF INNOVATION

Ledil Oy
Joensuunkatu 13
FIN 24100 SALO
Finland

DRAWN BY		DATE		DRAWING TITLE			
mav		21.08.2012		MELODY-3-M			
CHECKED BY		DATE		SIZE	DRAWING NUMBER		REV
pv		21.08.2012		A4	C13095		1
DESIGNED BY		DATE		SCALE	1:1	WEIGHT (g)	SHEET 1/1
mav		15.08.2012					

PHOTOMETRIC DATA (MEASURED):

CREE 

LED XP-E
 FWHM 31.0°
 Efficiency 93 %
 Peak intensity 2.3 cd/lm
 LEDs/each optic 1
 Light colour White
 Required components:

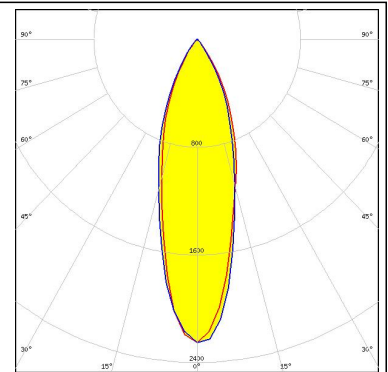
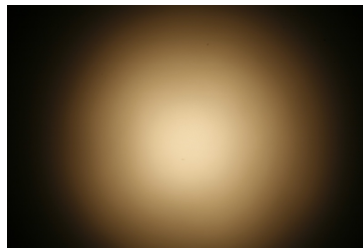

CREE 

LED XP-E2
 FWHM 34.0°
 Efficiency 92 %
 Peak intensity 1.9 cd/lm
 LEDs/each optic 1
 Light colour White
 Required components:

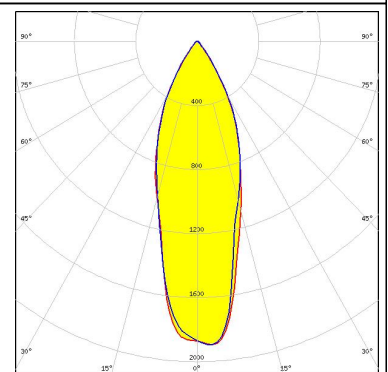
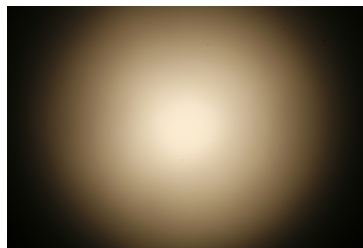

CREE 

LED XP-G
 FWHM 38.0°
 Efficiency 92 %
 Peak intensity 1.8 cd/lm
 LEDs/each optic 1
 Light colour White
 Required components:

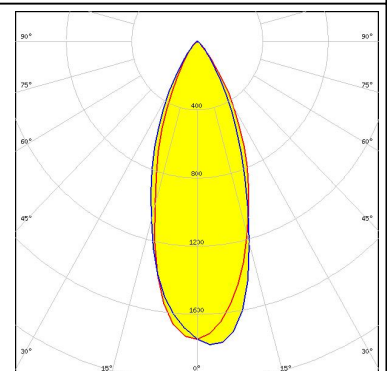
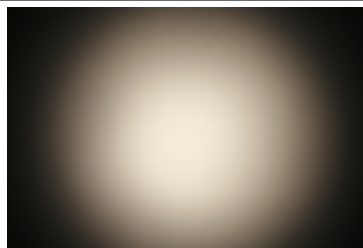

CREE 

LED XP-G2
 FWHM 41.0°
 Efficiency 93 %
 Peak intensity 1.7 cd/lm
 LEDs/each optic 1
 Light colour White
 Required components:

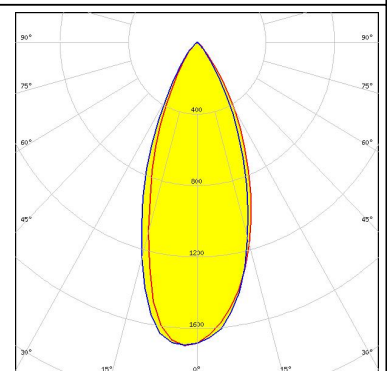
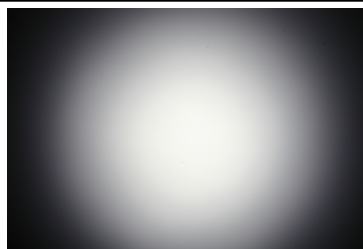

PHOTOMETRIC DATA (MEASURED):



LED XT-E
 FWHM 33.0°
 Efficiency 92 %
 Peak intensity 2.1 cd/lm
 LEDs/each optic 1
 Light colour White
 Required components:

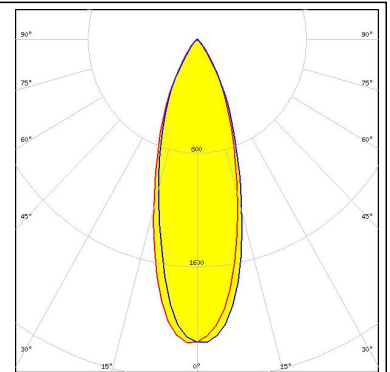
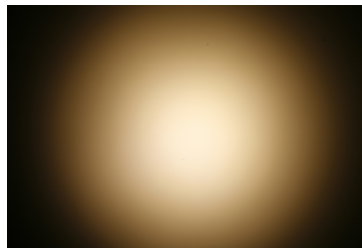

LED LUXEON A
 FWHM 39.0°
 Efficiency 93 %
 Peak intensity 1.8 cd/lm
 LEDs/each optic 1
 Light colour White
 Required components:

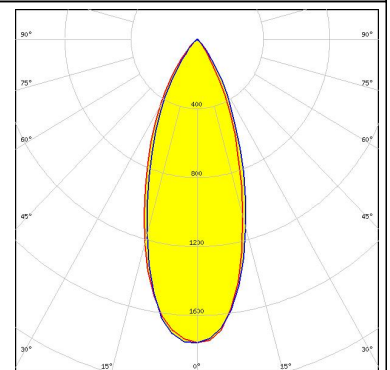
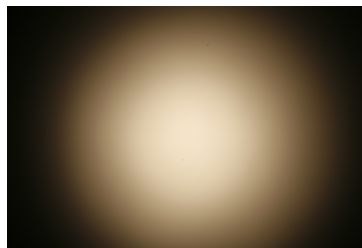



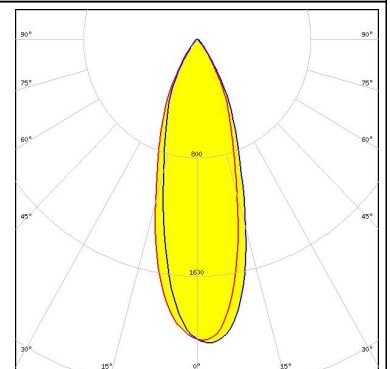
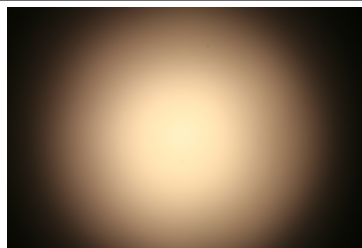

LED LUXEON R
 FWHM 33.0°
 Efficiency 92 %
 Peak intensity 2 cd/lm
 LEDs/each optic 1
 Light colour White
 Required components:

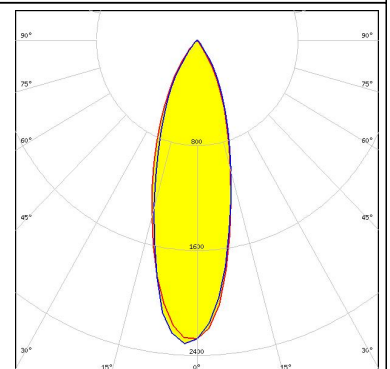
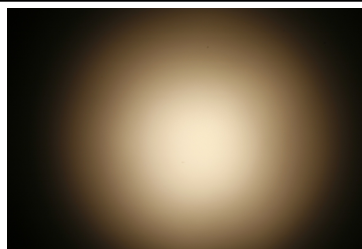

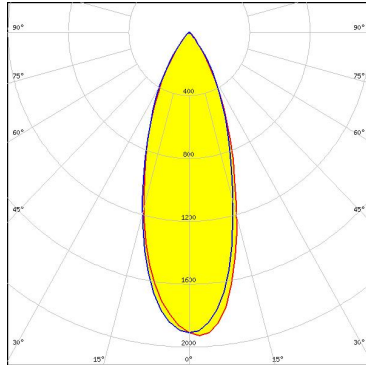
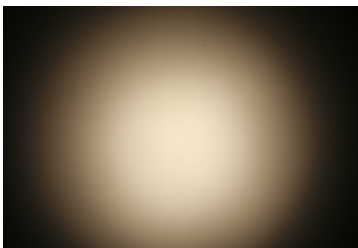
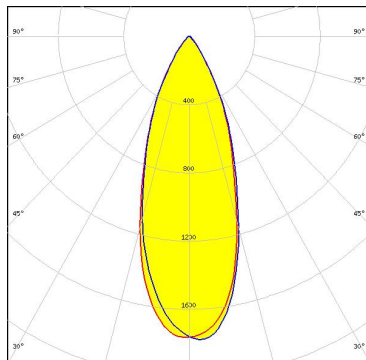

LED LUXEON Rebel
 FWHM 31.0°
 Efficiency 93 %
 Peak intensity 2.3 cd/lm
 LEDs/each optic 1
 Light colour White
 Required components:

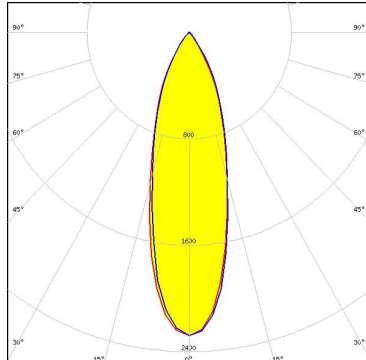
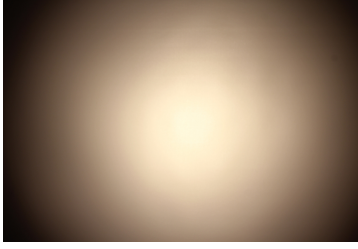

PHOTOMETRIC DATA (MEASURED):

<p>LUMILEDS</p> <p>LED LUXEON Rebel ES</p> <p>FWHM 37.0°</p> <p>Efficiency 92 %</p> <p>Peak intensity 1.9 cd/lm</p> <p>LEDs/each optic 1</p> <p>Light colour White</p> <p>Required components:</p>		
<p>LUMILEDS</p> <p>LED LUXEON T</p> <p>FWHM 37.0°</p> <p>Efficiency 92 %</p> <p>Peak intensity 1.7 cd/lm</p> <p>LEDs/each optic 1</p> <p>Light colour White</p> <p>Required components:</p>		
<p>LUMILEDS</p> <p>LED LUXEON TX</p> <p>FWHM 31.0°</p> <p>Efficiency 91 %</p> <p>Peak intensity 2.3 cd/lm</p> <p>LEDs/each optic 1</p> <p>Light colour White</p> <p>Required components:</p>		
<p>LUMILEDS</p> <p>LED LUXEON Z ES</p> <p>FWHM 25.0°</p> <p>Efficiency 90 %</p> <p>Peak intensity 3.1 cd/lm</p> <p>LEDs/each optic 1</p> <p>Light colour White</p> <p>Required components:</p>		

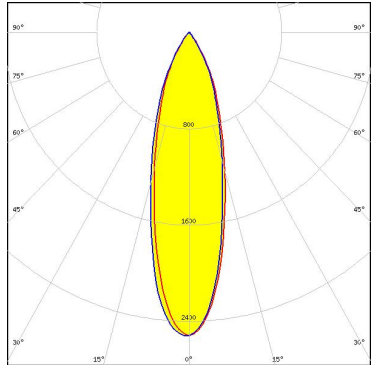
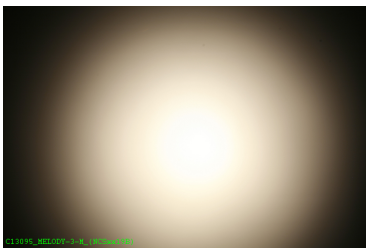
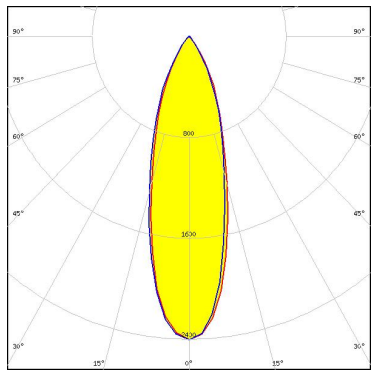
PHOTOMETRIC DATA (MEASURED):

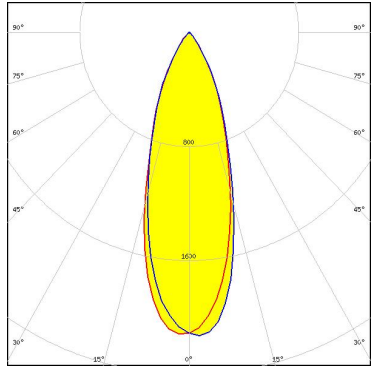
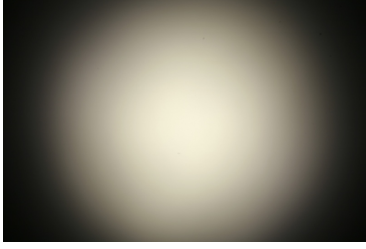
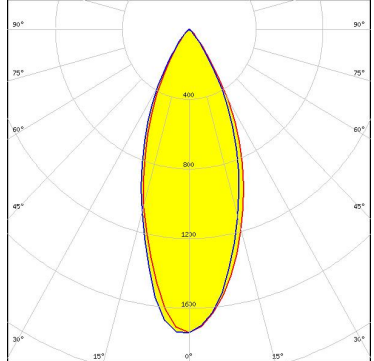
<p>NICHIA</p> <p>LED NCSxx19A FWHM 29.5° Efficiency 92 % Peak intensity 2.5 cd/lm LEDs/each optic 1 Light colour White Required components:</p>		
<p>NICHIA</p> <p>LED NCSxx19B FWHM 31.0° Efficiency 91 % Peak intensity 2.4 cd/lm LEDs/each optic 1 Light colour White Required components:</p>		
<p>NICHIA</p> <p>LED NVSxx19B/NVSxx19C FWHM 34.0° Efficiency 92 % Peak intensity 2.1 cd/lm LEDs/each optic 1 Light colour White Required components:</p>		
<p>OSRAM <small>Opto Semiconductors</small></p> <p>LED OSLOM Square EC FWHM 40.0° Efficiency 92 % Peak intensity 1.7 cd/lm LEDs/each optic 1 Light colour White Required components:</p>		

PHOTOMETRIC DATA (MEASURED):

OSRAM
Opto Semiconductors

LED OSLON SSL 150
FWHM 31.0°
Efficiency 93 %
Peak intensity 2.5 cd/lm
LEDs/each optic 1
Light colour White
Required components:

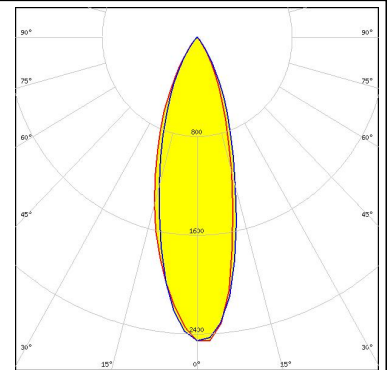

OSRAM
Opto Semiconductors

LED OSLON SSL 80
FWHM 29.0°
Efficiency 92 %
Peak intensity 2.3 cd/lm
LEDs/each optic 1
Light colour White
Required components:

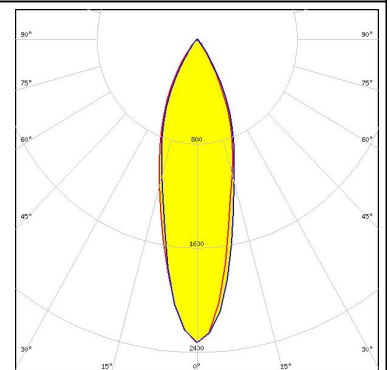
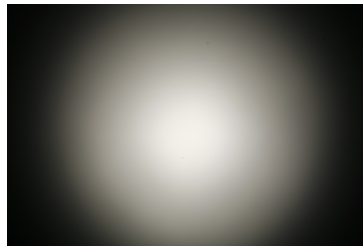

PHOTOMETRIC DATA (SIMULATED):



LED	LUXEON H50-2
FWHM	36.0°
Efficiency	92 %
Peak intensity	2 cd/m
LEDs/each optic	1
Light colour	White
Required components:	

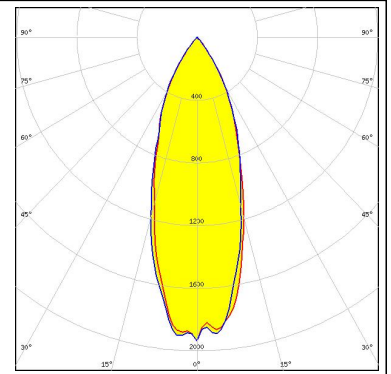

GENERAL INFORMATION:

NOTE: The typical beam angle will be changed by different color, chip size and chip position tolerance. The typical total beam angle is the full angle measured where the luminous intensity is half of the peak value.

MATERIALS:

As part of our continuous research and improvement processes, and to ensure the best possible quality and availability of our products, LEDiL reserves the right to change material grades without notice.

PRODUCT DATA USER AGREEMENT AND DISCLAIMER:

The measured data in the provided downloadable LEDiL Product Datasheets and Mechanical 2D-Drawings is rounded and provided as reference for planning. LEDiL Oy's optical specifications have been verified by conducting performance testing of the products in accordance with the company's quality system. The reported data are averaged results of multiple measurements with typical variation. LEDiL Oy reserves the right to without prior notification make changes and improvements to its products.

LEDiL Oy assumes neither warranty, nor guarantee nor any other liability of any kind for the contents and correctness of the provided data. The provided data has been generated with highest diligence but the provided data may in reality not represent the complete possible variation range of all intrinsic parameters. Therefore, in certain cases a deviation from the provided data could occur.

LEDiL Oy reserves the right to undertake technical changes of its products without further notification which could lead to changes in the provided data. LEDiL Oy assumes no liability of any kind for the possible deviation from any provided data or any other damage resulting from the usage of the provided data.

The user agrees to this disclaimer and user agreement with the download or usage of the provided files.

LEDiL Oy

Joensuunkatu 13
FI-24240 SALO
Finland

LEDiL Inc.

228 West Page Street
Suite D
Sycamore IL 60178
USA

Local sales and technical support

[www.ledil.com/
where_to_buy](http://www.ledil.com/where_to_buy)

Shipping locations

Salo, Finland
Hong Kong, China

Distribution Partners

[www.ledil.com/
where_to_buy](http://www.ledil.com/where_to_buy)