

RGBX-SS

~20° smooth spot beam optimized for Osram Ostar-SMT RGB. Assembly with holder.

TECHNICAL SPECIFICATIONS:

Dimensions	Ø 30.0 mm
Height	28 mm
Fastening	glue
ROHS compliant	yes ⓘ

MATERIAL SPECIFICATIONS:

Component	Type	Material	Colour	Finish
RGBX-SS	Single lens	PMMA	clear	
RGBX-O-SMT-HLD	Holder	PC	black	



ORDERING INFORMATION:

Component		Qty in box	MOQ	MPQ	Box weight (kg)
CP10960_RGBX-SS	Single lens	486		54	7.5
» Box size: 480 x 280 x 300 mm					

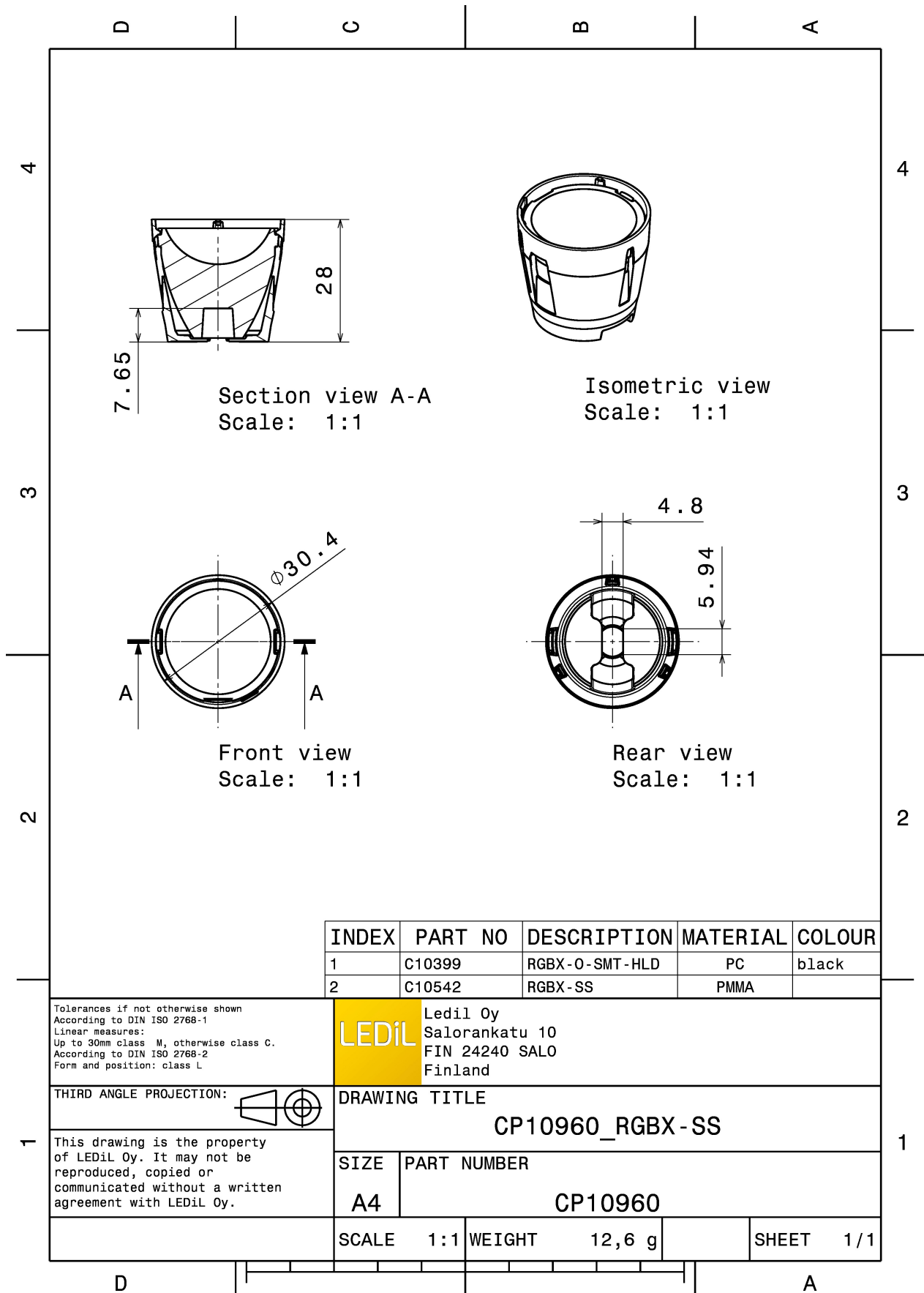

PHOTOMETRIC DATA (MEASURED):

LUMILEDS

LED LUXEON C
 FWHM 22.0°
 Efficiency 76 %
 Peak intensity 2.7 cd/lm
 LEDs/each optic 4
 Light colour RGBW
 Required components:

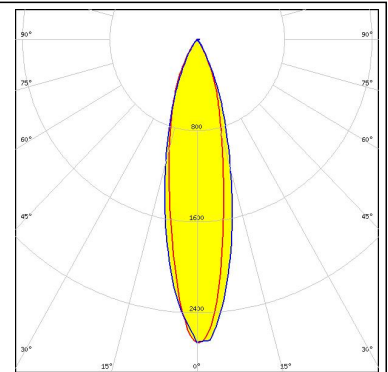
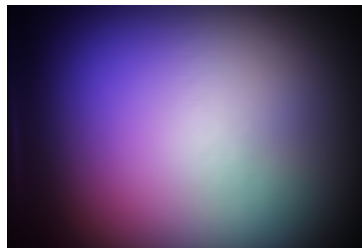

LUMILEDS

LED LUXEON CZ
 FWHM 24.0°
 Efficiency 80 %
 Peak intensity 3.1 cd/lm
 LEDs/each optic 4
 Light colour RGBW
 Required components:

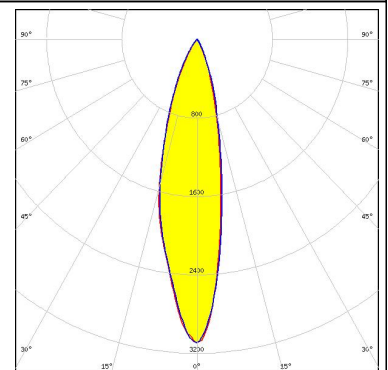
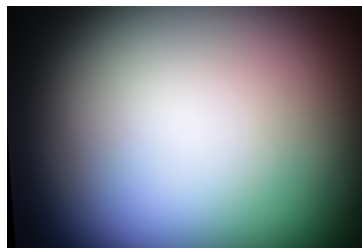

LUMINUS

LED SBM-40-RGBW
 FWHM 19.0°
 Efficiency 83 %
 Peak intensity 4.1 cd/lm
 LEDs/each optic 1
 Light colour White
 Required components:

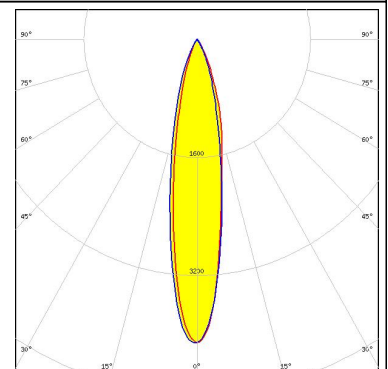
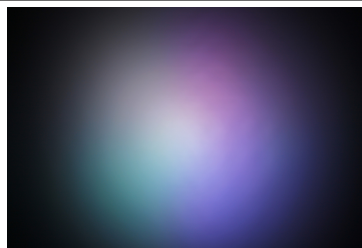

OSRAM

Opto Semiconductors
 LED Ostar-SMT RGB
 FWHM 18.0°
 Efficiency 85 %
 Peak intensity 4.4 cd/lm
 LEDs/each optic 1
 Light colour White
 Required components:

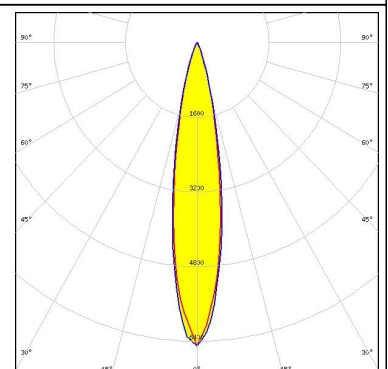
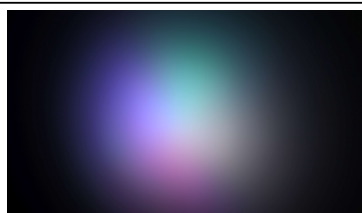

GENERAL INFORMATION:

NOTE: The typical beam angle will be changed by different color, chip size and chip position tolerance. The typical total beam angle is the full angle measured where the luminous intensity is half of the peak value.

MATERIALS:

As part of our continuous research and improvement processes, and to ensure the best possible quality and availability of our products, LEDiL reserves the right to change material grades without notice.

PRODUCT DATA USER AGREEMENT AND DISCLAIMER:

The measured data in the provided downloadable LEDiL Product Datasheets and Mechanical 2D-Drawings is rounded and provided as reference for planning. LEDiL Oy's optical specifications have been verified by conducting performance testing of the products in accordance with the company's quality system. The reported data are averaged results of multiple measurements with typical variation. LEDiL Oy reserves the right to without prior notification make changes and improvements to its products.

LEDiL Oy assumes neither warranty, nor guarantee nor any other liability of any kind for the contents and correctness of the provided data. The provided data has been generated with highest diligence but the provided data may in reality not represent the complete possible variation range of all intrinsic parameters. Therefore, in certain cases a deviation from the provided data could occur.

LEDiL Oy reserves the right to undertake technical changes of its products without further notification which could lead to changes in the provided data. LEDiL Oy assumes no liability of any kind for the possible deviation from any provided data or any other damage resulting from the usage of the provided data.

The user agrees to this disclaimer and user agreement with the download or usage of the provided files.

LEDiL Oy

Joensuunkatu 13
FI-24240 SALO
Finland

LEDiL Inc.

228 West Page Street
Suite D
Sycamore IL 60178
USA

Local sales and technical support

[www.ledil.com/
where_to_buy](http://www.ledil.com/where_to_buy)

Shipping locations

Salo, Finland
Hong Kong, China

Distribution Partners

[www.ledil.com/
where_to_buy](http://www.ledil.com/where_to_buy)