

Features

- 21 dB Adjustable Gain
- 2.25 dB Noise Figure
- +5 V, 95 mA Adjustable Bias
- Low Distortion
- Wide Bandwidth for DOCSIS 3.1
- Lead-Free MSOP8-EP Package
- RoHS* Compliant and 260°C Reflow Compatible

Description

The MAAM-011184 is a 75 Ω single ended GaAs MMIC amplifier assembled in a lead-free MSOP8-EP package. This device provides high gain, low noise, and excellent linearity from 5 - 300 MHz.

This amplifier is ideally suited for use in CATV return path applications, including DOCSIS 3.1 systems: it typically provides 2.25 dB noise figure, 64 dBm OIP2 and 43 dBm OIP3 while drawing 95 mA DC current at 5 V bias.

Ordering Information¹

Part Number	Package
MAAM-011184-TR1000	1000 piece reel
MAAM-011184-TR3000	3000 piece reel
MAAM-011184-001SMB	Sample Board

1. All sample boards include 5 loose parts.

Functional Schematic

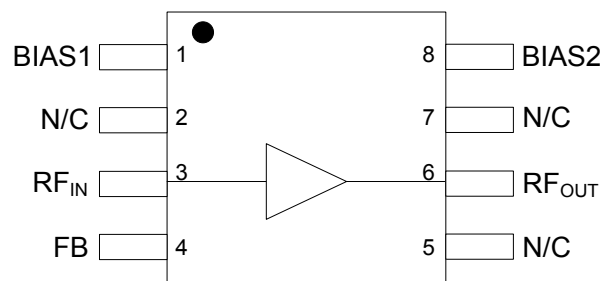

Pin Configuration²

Pin No.	Pin Name	Description
1	BIAS1	V _{CC} Bias
2	N/C	No Connection
3	RF _{IN}	RF Input
4	FB	Feedback
5	N/C	No Connection
6	RF _{OUT}	RF Output (DC Bias)
7	N/C	No Connection
8	BIAS2	Active Bias
9	Pad ³	RF and DC Ground

2. All pins listed as 'No Connection' should be grounded.
3. The exposed pad centered on the package bottom must be connected to RF and DC ground.

* Restrictions on Hazardous Substances, European Union Directive 2011/65/EU.

CATV Return Path Amplifier 5 - 300 MHz

Rev. V2

Electrical Specifications⁴: $T_A = 25^\circ\text{C}$, $V_{CC} = 5\text{ V}$, $Z_0 = 75\ \Omega$

Parameter	Test Conditions	Units	Min.	Typ.	Max.
Gain	$P_{IN} = -21\text{ dBm}$, 5 - 300 MHz $P_{IN} = -21\text{ dBm}$, 205 MHz	dB	— 20	21 21	—
Input Return Loss	$P_{IN} = -21\text{ dBm}$, 5 - 300 MHz	dB	—	26	—
Output Return Loss	$P_{IN} = -21\text{ dBm}$, 5 - 300 MHz	dB	—	23	—
Reverse Isolation	$P_{IN} = -21\text{ dBm}$, 5 - 300 MHz	dB	—	23	—
Noise Figure	5 - 205 MHz 205 - 300 MHz	dB	—	2.25 2.5	—
P1dB	5 - 300 MHz	dBm	—	21.7	—
OIP3 ⁵	$P_{IN} = -21\text{ dBm}$ per tone, 3 MHz spacing, $f_1 = 5 - 205\text{ MHz}$ $P_{IN} = -21\text{ dBm}$ per tone, 3 MHz spacing, $f_1 = 205\text{ MHz}$	dBm	— 38	43 41	—
OIP2 ⁵	$P_{IN} = -21\text{ dBm}$ per tone, 3 MHz spacing, $f_1 = 5 - 205\text{ MHz}$	dBm	—	64	—
Output Power at 30 dB MER ⁶	16 Channels, 5 - 205 MHz	dBmV/Channel	—	51	—
I_{CC} ⁷	$V_{CC} = 5\text{ V}$	mA	—	95	115

4. Data corresponds to the typical application circuit shown on page 3 of this datasheet. See pages 4 and 5 for typical performance using this application circuit.

5. f_1 is the frequency of the lower of the two input tones. Higher tone $f_2 = f_1 + 3\text{ MHz}$. OIP2 is measured at intermodulation frequency $f_1 + f_2$.

6. Modulation Error Ratio, 64 QAM 5.12 MS/s.

7. I_{CC} is the total DC current draw from the V_{CC} supply. As shown on page 3 of this datasheet, it is distributed to device pins 1, 6, and 8.

Absolute Maximum Ratings^{8,9}

Parameter	Absolute Maximum
Input Power	11 dBm
V_{CC}	6 V
Junction Temperature ^{10,11}	+150°C
Operating Temperature	-40°C to +85°C
Storage Temperature	-65°C to +125°C

8. Exceeding any one or a combination of these limits may cause permanent damage to this device.

9. MACOM does not recommend sustained operation near these survivability limits.

10. Operating at nominal conditions with $T_J \leq 150^\circ\text{C}$ will ensure $\text{MTTF} > 1 \times 10^6$ hours.

11. Junction Temperature (T_J) = $T_C + \Theta_{jc} * (V * I)$
Typical thermal resistance (Θ_{jc}) = 44° C/W.

a) For $T_C = +25^\circ\text{C}$,

$T_J = 46^\circ\text{C}$ @ 5 V, 95 mA

b) For $T_C = +85^\circ\text{C}$,

$T_J = 106^\circ\text{C}$ @ 5 V, 95 mA

Handling Procedures

Please observe the following precautions to avoid damage:

Static Sensitivity

Gallium Arsenide Integrated Circuits are sensitive to electrostatic discharge (ESD) and can be damaged by static electricity. Proper ESD control techniques should be used when handling these devices.

Typical Application Circuit: Schematic

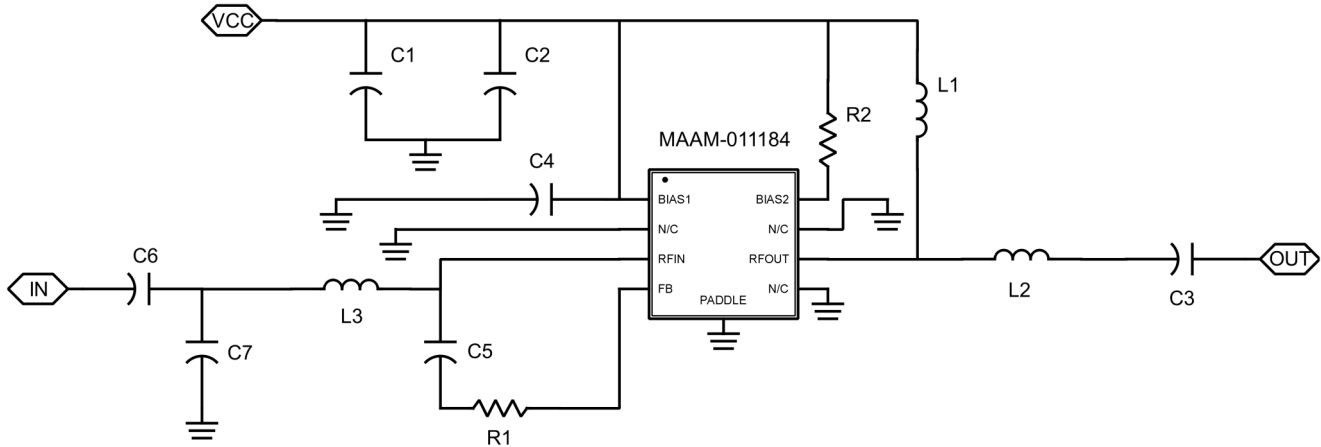

Typical Application Circuit: Component Values

Component	Value
C1 - C6	100 nF
C7	0.5 pF
R1 ¹²	330 Ω
R2 ¹²	SHORT - 0 Ω
L1 ¹³	22 μ H
L2	27 nH
L3	10 nH

12. Designers may decrease resistor R1 to reduce the gain of the amplifier by approximately 1 dB per 164 Ohms. Below 19.8 dB gain, typical input and output return losses fall below 20 dB. Resistor R2 may be increased in order to reduce bias current I_{CC} (at the cost of large-signal performance) by approximately 1 mA per 42 Ohms.

13. Low-ESR inductor LQH2MCN220K02 from Murata.

Typical Application Circuit: Sample Board Layout

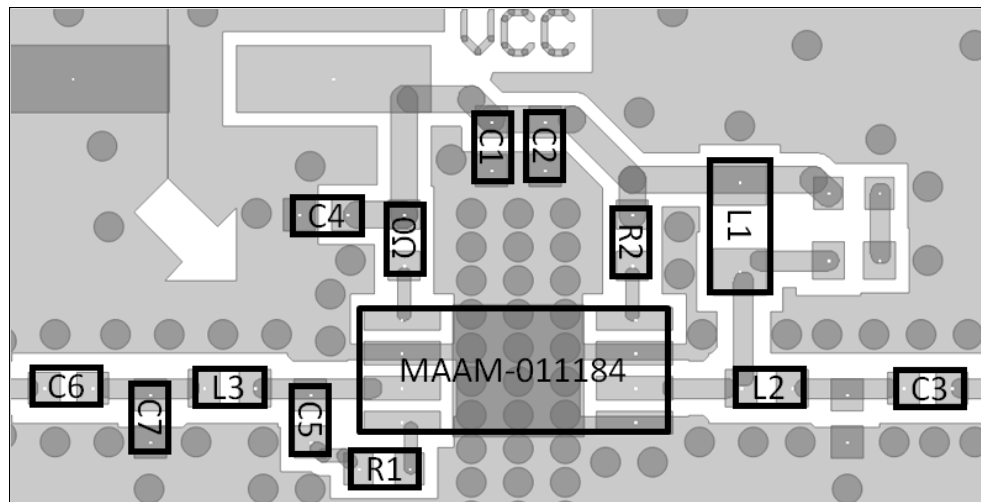

Typical Performance Curves: Small-Signal

Gain

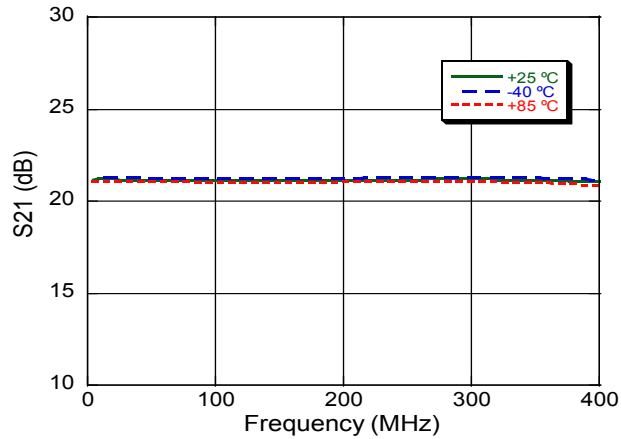

Reverse Isolation

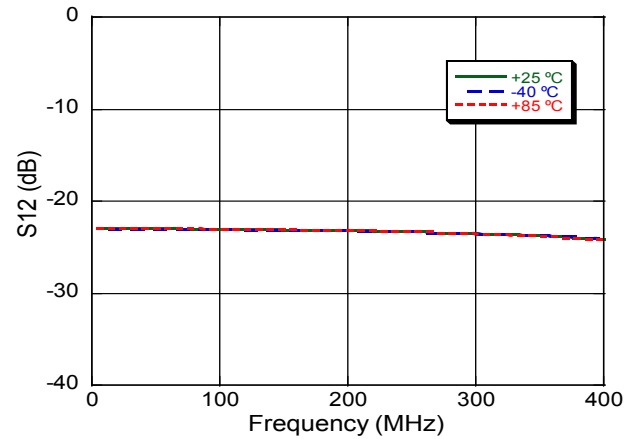

Input Return Loss

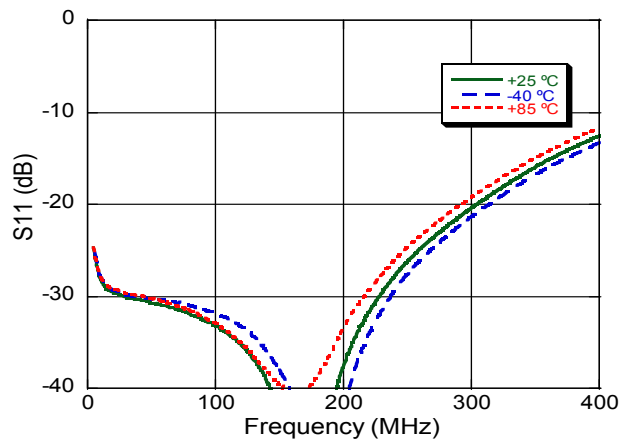

Output Return Loss

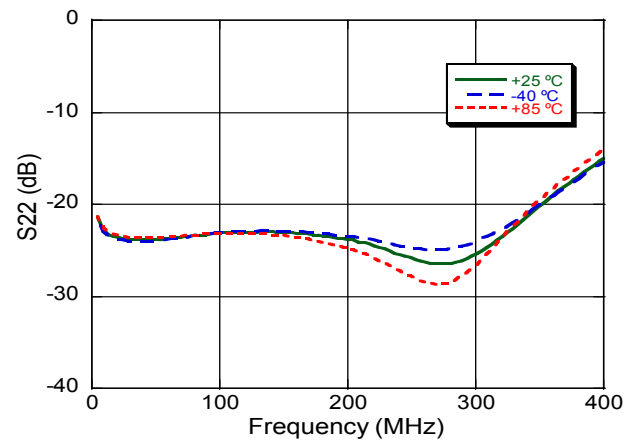

Noise Figure

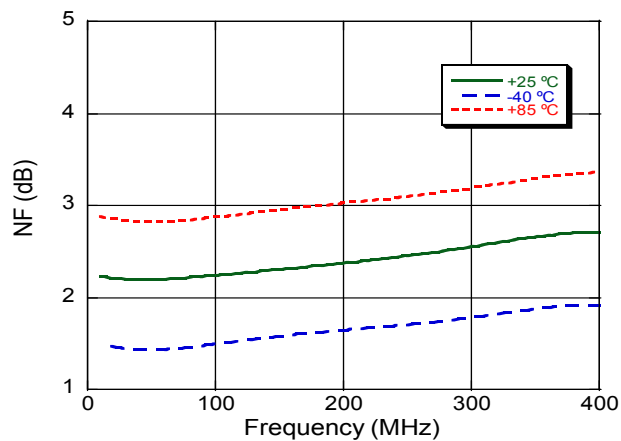

Typical Performance Curves: Large-Signal

P1dB

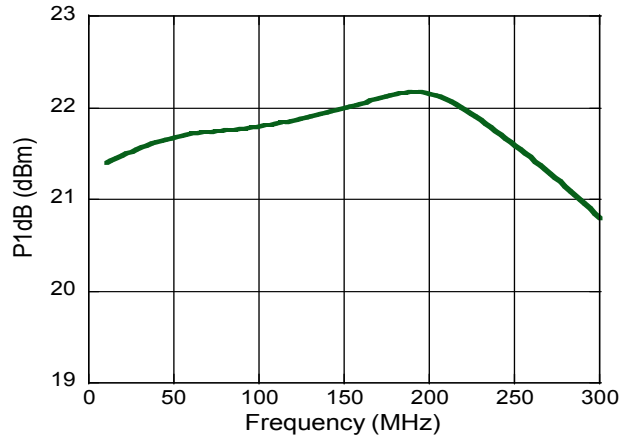

OIP2

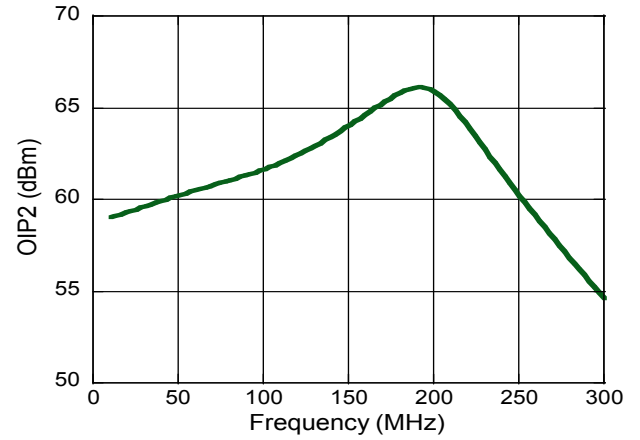

OIP3

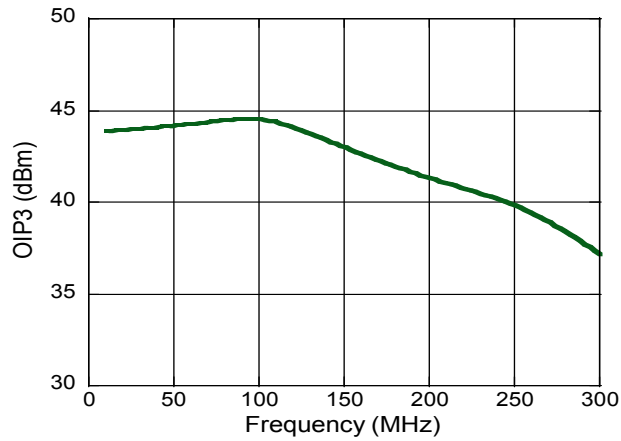

MER, 16 Channels 64-QAM

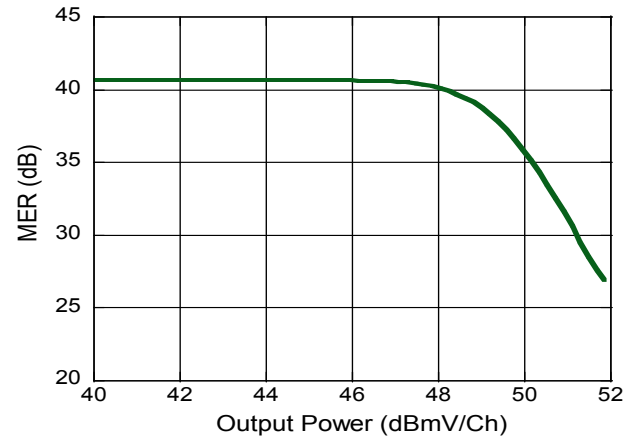

Lead-Free MSOP8-EP Package[†]

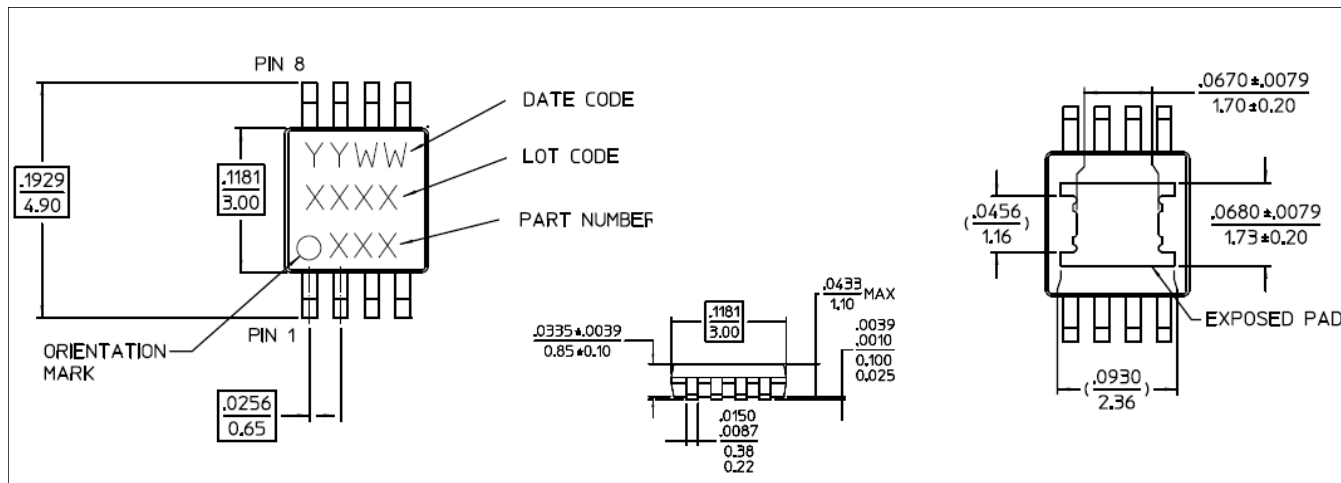

[†] Dimensions shown as inches over millimeters [in/mm].
Meets JEDEC moisture sensitivity level 1 requirements.
Plating is 100% matte tin over copper.

M/A-COM Technology Solutions Inc. All rights reserved.

Information in this document is provided in connection with M/A-COM Technology Solutions Inc ("MACOM") products. These materials are provided by MACOM as a service to its customers and may be used for informational purposes only. Except as provided in MACOM's Terms and Conditions of Sale for such products or in any separate agreement related to this document, MACOM assumes no liability whatsoever. MACOM assumes no responsibility for errors or omissions in these materials. MACOM may make changes to specifications and product descriptions at any time, without notice. MACOM makes no commitment to update the information and shall have no responsibility whatsoever for conflicts or incompatibilities arising from future changes to its specifications and product descriptions. No license, express or implied, by estoppel or otherwise, to any intellectual property rights is granted by this document.

THESE MATERIALS ARE PROVIDED "AS IS" WITHOUT WARRANTY OF ANY KIND, EITHER EXPRESS OR IMPLIED, RELATING TO SALE AND/OR USE OF MACOM PRODUCTS INCLUDING LIABILITY OR WARRANTIES RELATING TO FITNESS FOR A PARTICULAR PURPOSE, CONSEQUENTIAL OR INCIDENTAL DAMAGES, MERCHANTABILITY, OR INFRINGEMENT OF ANY PATENT, COPYRIGHT OR OTHER INTELLECTUAL PROPERTY RIGHT. MACOM FURTHER DOES NOT WARRANT THE ACCURACY OR COMPLETENESS OF THE INFORMATION, TEXT, GRAPHICS OR OTHER ITEMS CONTAINED WITHIN THESE MATERIALS. MACOM SHALL NOT BE LIABLE FOR ANY SPECIAL, INDIRECT, INCIDENTAL, OR CONSEQUENTIAL DAMAGES, INCLUDING WITHOUT LIMITATION, LOST REVENUES OR LOST PROFITS, WHICH MAY RESULT FROM THE USE OF THESE MATERIALS.

MACOM products are not intended for use in medical, lifesaving or life sustaining applications. MACOM customers using or selling MACOM products for use in such applications do so at their own risk and agree to fully indemnify MACOM for any damages resulting from such improper use or sale.