



# High-Power, Quad, Monolithic, PSE Controllers for Power over Ethernet

MAX5965A/MAX5965B

## General Description

The MAX5965A/MAX5965B are quad, monolithic, -48V power controllers designed for use in IEEE® 802.3af-compliant/pre-IEEE 802.3at-compatible power-sourcing equipment (PSE). These devices provide powered device (PD) discovery, classification, current limit, DC and AC load disconnect detections in compliance with the IEEE 802.3af standard. The MAX5965A/MAX5965B are pin compatible with the MAX5952/MAX5945/LTC4258/LTC4259A PSE controllers and provide additional features.

The MAX5965A/MAX5965B feature a high-power mode that provides up to 45W per port. The MAX5965A/MAX5965B provide new Class 5 and 2-event classification (Class 6) for detection and classification of high-power PDs. The MAX5965A/MAX5965B provide instantaneous readout of each port current through the I<sup>2</sup>C interface. The MAX5965A/MAX5965B also provide high-capacitance detection for legacy PDs.

These devices feature an I<sup>2</sup>C-compatible, 3-wire serial interface, and are fully software configurable and programmable. The class-overcurrent detection function enables system power management to detect if a PD draws more than the allowable current. The MAX5965A/MAX5965B's extensive programmability enhances system flexibility, enables field diagnosis, and allows for uses in other applications.

The MAX5965A/MAX5965B provide four operating modes to suit different system requirements. Auto mode allows the devices to operate automatically without any software supervision. Semi-automatic mode automatically detects and classifies a device connected to a port after initial software activation, but does not power up that port until instructed to by software. Manual mode allows total software control of the device and is useful for system diagnostics. Shutdown mode terminates all activities and securely turns off power to the ports.

The MAX5965A/MAX5965B provide input undervoltage lockout (UVLO), input undervoltage detection, a load-stability safety check during detection, input overvoltage lockout, overtemperature detection, output voltage slew-rate limit during startup, power-good status, and fault status. The MAX5965A/MAX5965B's programmability includes startup timeout, overcurrent timeout, and load-disconnect detection timeout.

The MAX5965A/MAX5965B are available in a 36-pin SSOP package and are rated for both extended (-40°C to +85°C) and upper commercial (0°C to +85°C) temperature ranges.

## Applications

Power-Sourcing Equipment (PSE)  
Switches/Routers  
Midspan Power Injectors

IEEE is a registered service mark of the Institute of Electrical and Electronics Engineers, Inc.



## Features

- ◆ IEEE 802.3af Compliant/Pre-IEEE 802.3at Compatible
- ◆ Instantaneous Readout of Port Current Through I<sup>2</sup>C Interface
- ◆ High-Power Mode Enables Up to 45W Per Port
- ◆ High-Capacitance Detection for Legacy Devices
- ◆ Pin Compatible with MAX5952/MAX5945/LTC4258/LTC4259A
- ◆ Four Independent Power-Switch Controllers
- ◆ PD Detection and Classification (Including 2-Event Classification)
- ◆ Selectable Load-Stability Safety Check During Detection
- ◆ Supports Both DC and AC Load Removal Detections
- ◆ I<sup>2</sup>C-Compatible, 3-Wire Serial Interface
- ◆ Current Foldback and Duty-Cycle-Controlled Current Limit
- ◆ Open-Drain INT Signal
- ◆ Direct Fast Shutdown Control Capability
- ◆ Special Class 5 Classification

## Ordering Information

PART	TEMP RANGE	PIN-PACKAGE
MAX5965AEAX+	-40°C to +85°C	36 SSOP
MAX5965AUAX+*	0°C to +85°C	36 SSOP
MAX5965BEAX+	-40°C to +85°C	36 SSOP
MAX5965BUAX+*	0°C to +85°C	36 SSOP

+ Denotes a lead(Pb)-free/RoHS-compliant package.

\* Future product—contact factory for availability.

## Selector Guide

PART	PIN-PACKAGE	AC DISCONNECT FEATURE
MAX5965AEAX+	36 SSOP	No
MAX5965AUAX+	36 SSOP	No
MAX5965BEAX+	36 SSOP	Yes
MAX5965BUAX+	36 SSOP	Yes

Pin Configuration appears at end of data sheet.

# High-Power, Quad, Monolithic, PSE Controllers for Power over Ethernet

## ABSOLUTE MAXIMUM RATINGS

(Voltages referenced to  $V_{EE}$ , unless otherwise noted.)  
 AGND, DGND, DET\_,  $V_{DD}$ , RESET, A3–A0, SHD\_, OSC,  
 SCL, SDAIN, AUTO ..... -0.3V to +80V  
 OUT\_ ..... -12V to (AGND + 0.3V)  
 GATE\_ (internally clamped) (Note 1) ..... -0.3V to +11.4V  
 SENSE\_ ..... -0.3V to +24V  
 $V_{DD}$ , RESET, MIDSPAN, A3–A0, SHD\_, OSC, SCL,  
 SDAIN and AUTO to DGND ..... -0.3V to +7V  
 INT and SDAOUT to DGND ..... -0.3V to +12V

Maximum Current into INT, SDAOUT, DET\_ ..... 80mA  
 Maximum Power Dissipation ( $T_A = +70^\circ\text{C}$ )  
 36-Pin SSOP (derate 17.4mW/ $^\circ\text{C}$  above +70 $^\circ\text{C}$ ) ..... 1388.9mW  
 Operating Temperature Ranges:  
 MAX5965A/MAX5965B\_EAX ..... -40 $^\circ\text{C}$  to +85 $^\circ\text{C}$   
 MAX5965A/MAX5965B\_UAX ..... 0 $^\circ\text{C}$  to +85 $^\circ\text{C}$   
 Storage Temperature Range ..... -65 $^\circ\text{C}$  to +150 $^\circ\text{C}$   
 Junction Temperature ..... +150 $^\circ\text{C}$   
 Lead Temperature (soldering, 10s) ..... +300 $^\circ\text{C}$

**Note 1:** GATE\_ is internally clamped to 11.4V above  $V_{EE}$ . Driving GATE\_ higher than 11.4V above  $V_{EE}$  may damage the device.

Stresses beyond those listed under "Absolute Maximum Ratings" may cause permanent damage to the device. These are stress ratings only, and functional operation of the device at these or any other conditions beyond those indicated in the operational sections of the specifications is not implied. Exposure to absolute maximum rating conditions for extended periods may affect device reliability.

## ELECTRICAL CHARACTERISTICS

( $V_{AGND} = 32\text{V}$  to  $60\text{V}$ ,  $V_{EE} = 0\text{V}$ ,  $V_{DD}$  to  $V_{DGND} = +3.3\text{V}$ , all voltages are referenced to  $V_{EE}$ , unless otherwise noted. Typical values are at  $V_{AGND} = +48\text{V}$ ,  $V_{DGND} = +48\text{V}$ ,  $V_{DD} = (V_{DGND} + 3.3\text{V})$ ,  $T_A = +25^\circ\text{C}$ . Currents are positive when entering the pin and negative otherwise.) (Note 2)

PARAMETER	SYMBOL	CONDITIONS	MIN	TYP	MAX	UNITS
<b>POWER SUPPLIES</b>						
Operating Voltage Range	$V_{AGND}$	$V_{AGND} - V_{EE}$	32		60	V
	$V_{DGND}$		0		60	
	$V_{DD}$	$V_{DD}$ to $V_{DGND}$ , $V_{DGND} = V_{AGND}$	2.4		3.6	
		$V_{DD}$ to $V_{DGND}$ , $V_{DGND} = V_{EE}$	3.0		3.6	
Supply Currents	$I_{EE}$	$V_{OUT\_} = V_{EE}$ , $V_{SENSE\_} = V_{EE}$ , $DET\_ = AGND$ , all logic inputs open, $SCL = SDAIN = V_{DD}$ . INT and SDAOUT unconnected. Measured at AGND in power mode after GATE_ pullup		4.8	6.8	mA
	$I_{DIG}$	All logic inputs high, measured at $V_{DD}$		0.2	0.4	
<b>GATE DRIVER AND CLAMPING</b>						
GATE_ Pullup Current	$I_{PU}$	Power mode, gate drive on, $V_{GATE\_} = V_{EE}$ (Note 3)	-40	-50	-65	$\mu\text{A}$
Weak GATE_ Pulldown Current	$I_{PDW}$	SHD_ = DGND, $V_{GATE\_} = V_{EE} + 10\text{V}$		42		$\mu\text{A}$
Maximum Pulldown Current	$I_{PDS}$	$V_{SENSE\_} = 600\text{mV}$ , $V_{GATE\_} = V_{EE} + 2\text{V}$		100		mA
External Gate Drive	$V_{GS}$	$V_{GATE\_} - V_{EE}$ , power mode, gate drive on, $I_{PU} = 1\mu\text{A}$	9	10	11.5	V

# High-Power, Quad, Monolithic, PSE Controllers for Power over Ethernet

MAX5965A/MAX5965B

## ELECTRICAL CHARACTERISTICS (continued)

(V<sub>AGND</sub> = 32V to 60V, V<sub>EE</sub> = 0V, V<sub>DD</sub> to V<sub>DGND</sub> = +3.3V, all voltages are referenced to V<sub>EE</sub>, unless otherwise noted. Typical values are at V<sub>AGND</sub> = +48V, V<sub>DGND</sub> = +48V, V<sub>DD</sub> = (V<sub>DGND</sub> + 3.3V), T<sub>A</sub> = +25°C. Currents are positive when entering the pin and negative otherwise.) (Note 2)

PARAMETER	SYMBOL	CONDITIONS	MIN	TYP	MAX	UNITS	
<b>CURRENT LIMIT</b>							
Current-Limit Clamp Voltage	V <sub>SU_LIM</sub>	Maximum V <sub>SENSE_</sub> allowed during current limit, V <sub>OUT_</sub> = 0V (ICUT = 000) (Note 4)	I <sub>VEE</sub> = 00	202	212	220	mV
			I <sub>VEE</sub> = 01	192	202	212	
			I <sub>VEE</sub> = 10	186	190	200	
			I <sub>VEE</sub> = 11	170	180	190	
Overcurrent Threshold After Startup	V <sub>FLT_LIM</sub>	Overcurrent V <sub>SENSE_</sub> threshold allowed for t ≤ t <sub>FAULT</sub> after startup; V <sub>OUT_</sub> = 0V, (I <sub>VEE</sub> = 00)	ICUT = 000 (Class 0/3)	177	186	196	mV
			ICUT = 110 (Class 1)	47	55	64	
			ICUT = 111 (Class 2)	86	94	101	
			ICUT = 001	265	280	295	
			ICUT = 010	310	327	345	
			ICUT = 011	355	374	395	
			ICUT = 100	398	419	440	
			ICUT = 101	443	466	488	
Foldback Initial OUT_ Voltage	V <sub>FLBK_ST</sub>	V <sub>OUT_</sub> - V <sub>EE</sub> , above which the current-limit trip voltage starts folding back, I <sub>VEE</sub> = 00	ICUT = 000, ICUT = 110, ICUT = 111	32		V	
			ICUT = 001...101	13			
Foldback Final OUT_ Voltage	V <sub>FLBK_END</sub>	I <sub>VEE</sub> = 00, ICUT = 000, V <sub>OUT_</sub> - V <sub>EE</sub> above which the current-limit trip voltage reaches V <sub>TH_FB</sub>	50		V		
Minimum Foldback Current-Limit Threshold	V <sub>TH_FB</sub>	V <sub>OUT_</sub> = AGND = 60V, I <sub>VEE</sub> = 00, ICUT = 000	64		mV		
SENSE_ Input Bias Current		V <sub>SENSE_</sub> = V <sub>EE</sub>	-5	+5		μA	

# High-Power, Quad, Monolithic, PSE Controllers for Power over Ethernet

## ELECTRICAL CHARACTERISTICS (continued)

( $V_{AGND} = 32V$  to  $60V$ ,  $V_{EE} = 0V$ ,  $V_{DD}$  to  $V_{DGND} = +3.3V$ , all voltages are referenced to  $V_{EE}$ , unless otherwise noted. Typical values are at  $V_{AGND} = +48V$ ,  $V_{DGND} = +48V$ ,  $V_{DD} = (V_{DGND} + 3.3V)$ ,  $T_A = +25^\circ C$ . Currents are positive when entering the pin and negative otherwise.) (Note 2)

PARAMETER	SYMBOL	CONDITIONS	MIN	TYP	MAX	UNITS
<b>SUPPLY MONITORS</b>						
$V_{EE}$ Undervoltage Lockout	$V_{EEUVLO}$	$AGND - V_{EE}$ , $AGND - V_{EE}$ increasing		28.5		V
$V_{EE}$ Undervoltage Lockout Hysteresis	$V_{EEUVLOH}$	Ports shut down if $AGND - V_{EE} < V_{UVLO} - V_{EEUVLOH}$		3		V
$V_{EE}$ Overvoltage Lockout	$V_{EE\_OV}$	$V_{EE\_OV}$ event bit sets and ports shut down if $AGND - V_{EE} > V_{EE\_OV}$ , $AGND$ increasing		62.5		V
$V_{EE}$ Overvoltage Lockout Hysteresis	$V_{OVH}$			1		V
$V_{EE}$ Undervoltage	$V_{EE\_UV}$	$V_{EE\_UV}$ event bit is set if $AGND - V_{EE} < V_{EE\_UV}$ , $V_{EE}$ increasing		40		V
$V_{DD}$ Overvoltage	$V_{DD\_OV}$	$V_{DD\_OV}$ event bit is set if $V_{DD} - V_{DGND} > V_{DD\_OV}$ ; $V_{DD}$ increasing		3.82		V
$V_{DD}$ Undervoltage	$V_{DD\_UV}$	$V_{DD\_UV}$ is set if $V_{DD} - V_{DGND} > V_{DD\_UV}$ , $V_{DD}$ decreasing		2.7		V
$V_{DD}$ Undervoltage Lockout	$V_{DDUVLO}$	Device operates when $V_{DD} - DGND > V_{DDUVLO}$ , $V_{DD}$ increasing		2		V
$V_{DD}$ Undervoltage Lockout Hysteresis	$V_{DDHYS}$			120		mV
Thermal Shutdown Threshold	$T_{SHD}$	Ports shut down and device resets if its junction temperature exceeds this limit, temperature increasing (Note 5)		+150		$^\circ C$
Thermal Shutdown Hysteresis	$T_{SHDH}$	Thermal hysteresis, temperature decreasing (Note 5)		20		$^\circ C$
<b>OUTPUT MONITOR</b>						
OUT_ Input Current	$I_{BOUT}$	$V_{OUT\_} = AGND$ , all modes			2	$\mu A$
Idle Pullup Current at OUT_	$I_{DIS}$	OUT_ discharge current, detection and classification off, port shutdown, $V_{OUT\_} = AGND - 2.8V$	200		265	$\mu A$
PGOOD High Threshold	$PG_{TH}$	$V_{OUT\_} - V_{EE}$ , OUT_ decreasing	1.5	2.0	2.5	V
PGOOD Hysteresis	$PG_{HYS}$			220		mV
PGOOD Low-to-High Glitch Filter	$tp_{GOOD}$	Minimum time PGOOD has to be high to set bit in register 10h		3		ms

# High-Power, Quad, Monolithic, PSE Controllers for Power over Ethernet

MAX5965A/MAX5965B

## ELECTRICAL CHARACTERISTICS (continued)

(V<sub>AGND</sub> = 32V to 60V, V<sub>EE</sub> = 0V, V<sub>DD</sub> to V<sub>DGND</sub> = +3.3V, all voltages are referenced to V<sub>EE</sub>, unless otherwise noted. Typical values are at V<sub>AGND</sub> = +48V, V<sub>DGND</sub> = +48V, V<sub>DD</sub> = (V<sub>DGND</sub> + 3.3V), T<sub>A</sub> = +25°C. Currents are positive when entering the pin and negative otherwise.) (Note 2)

PARAMETER	SYMBOL	CONDITIONS	MIN	TYP	MAX	UNITS	
<b>LOAD DISCONNECT</b>							
DC Load Disconnect Threshold	V <sub>DCTH</sub>	Minimum V <sub>SENSE_</sub> allowed before disconnect (DC disconnect active), V <sub>OUT_</sub> = 0V	2.5	3.75	5.0	mV	
AC Load Disconnect Threshold	I <sub>ACTH</sub>	Current into DET <sub>_</sub> , for I < I <sub>ACTH</sub> the port powers off, ACD_EN_bit = H; V <sub>OSC</sub> = 2.2V, MAX5965B (Note 6)	285	320	360	μA	
Oscillator Buffer Gain	A <sub>OSC</sub>	V <sub>DET_/VOSC</sub> , ACD_EN_bit = H, MAX5965B	2.9	3.0	3.1	V/V	
OSC Fail Threshold	V <sub>OSC_FAIL</sub>	Port does not power on if V <sub>OSC</sub> < V <sub>OSC_FAIL</sub> and ACD_EN_bit is high, MAX5965B (Note 7)	1.8		2.2	V	
OSC Input Impedance	Z <sub>OSC</sub>	OSC input impedance when all the ACD_EN_ are active, MAX5965B	100			kΩ	
Load Disconnect Timer	t <sub>DISC</sub>	Time from V <sub>SENSE_</sub> < V <sub>DCTH</sub> to gate shutdown (Note 8)	300		400	ms	
<b>DETECTION</b>							
Detection Probe Voltage (First Phase)	V <sub>DPH1</sub>	AGND - V <sub>DET_</sub> during the first detection phase	3.8	4	4.2	V	
Detection Probe Voltage (Second Phase)	V <sub>DPH2</sub>	AGND - V <sub>DET_</sub> during the second detection phase	9.0	9.3	9.6	V	
Current-Limit Protection	I <sub>DLIM</sub>	V <sub>DET_</sub> = AGND, during detection, measure current through DET <sub>_</sub>	1.5	1.8	2.2	mA	
Short-Circuit Threshold	V <sub>DCP</sub>	If AGND - V <sub>OUT_</sub> < V <sub>DCP</sub> after the first detection phase a short circuit to AGND is detected		1		V	
Open-Circuit Threshold	I <sub>D_OPEN</sub>	First point measurement current threshold for open condition		12.5		μA	
Resistor Detection Window	R <sub>DOK</sub>	(Note 9)	19.0		26.5	kΩ	
Resistor Rejection Window	R <sub>DBAD</sub>	Detection rejects lower values			15.2	kΩ	
		Detection rejects higher values	32				
<b>CLASSIFICATION</b>							
Classification Probe Voltage	V <sub>CL</sub>	V <sub>AGND</sub> - V <sub>DET_</sub> during classification	16		20	V	
Current-Limit Protection	I <sub>CLIM</sub>	DET <sub>_</sub> = AGND, during classification	68		80	mA	
Classification Current Thresholds	I <sub>CL</sub>	Classification current thresholds between classes	Class 0, Class 1	5.5	6.5	7.5	mA
			Class 1, Class 2	13	14.5	16	
			Class 2, Class 3	21	23	25	
			Class 3, Class 4	31	33	35	
			Class 4, Class 5	45	48	51	

# High-Power, Quad, Monolithic, PSE Controllers for Power over Ethernet

## ELECTRICAL CHARACTERISTICS (continued)

(V<sub>AGND</sub> = 32V to 60V, V<sub>EE</sub> = 0V, V<sub>DD</sub> to V<sub>DGND</sub> = +3.3V, all voltages are referenced to V<sub>EE</sub>, unless otherwise noted. Typical values are at V<sub>AGND</sub> = +48V, V<sub>DGND</sub> = +48V, V<sub>DD</sub> = (V<sub>DGND</sub> + 3.3V), T<sub>A</sub> = +25°C. Currents are positive when entering the pin and negative otherwise.) (Note 2)

PARAMETER	SYMBOL	CONDITIONS	MIN	TYP	MAX	UNITS
<b>DIGITAL INPUTS/OUTPUTS (Referred to DGND)</b>						
Digital Input Low	V <sub>IL</sub>				0.9	V
Digital Input High	V <sub>IH</sub>		2.4			V
Internal Input Pullup/Pulldown Resistor	R <sub>DIN</sub>	Pullup (pulldown) resistor to V <sub>DD</sub> (DGND) to set default level	25	50	75	kΩ
Open-Drain Output Low Voltage	V <sub>OL</sub>	I <sub>SINK</sub> = 15mA			0.4	V
Digital Input Leakage	I <sub>DL</sub>	Input connected to the pull voltage			2	μA
Open-Drain Leakage	I <sub>OL</sub>	Open-drain high impedance, V <sub>OUT_</sub> = 3.3V			2	μA
<b>TIMING</b>						
Startup Time	t <sub>START</sub>	Time during which a current limit set by V <sub>SU_LIM</sub> is allowed, starts when the GATE_ is turned on (Note 9)	50	60	70	ms
Fault Time	t <sub>FAULT</sub>	Maximum allowed time for an overcurrent condition set by V <sub>FLT_LIM</sub> after startup (Note 9)	50	60	70	ms
Port Turn-Off Time	t <sub>OFF</sub>	Minimum delay between any port turning off, does not apply in case of a reset		0.5		ms
Detection Reset Time		Time allowed for the port voltage to reset before detection starts		80	90	ms
Detection Time	t <sub>DET</sub>	Maximum time allowed before detection is completed			330	ms
Midspan Mode Detection Delay	t <sub>DMID</sub>		2.0		2.4	s
Classification Time	t <sub>CLASS</sub>	Time allowed for classification		19	23	ms
VEEU <sub>VLO</sub> Turn-On Delay	t <sub>DLY</sub>	Time V <sub>AGND</sub> must be above the VEEU <sub>VLO</sub> thresholds before the device operates	2		4	ms
Restart Timer	t <sub>RESTART</sub>	Time a port has to wait before turning on after an overcurrent fault during normal operation, RSTR_EN_ bits = high	RSTR bits = 00		16 x t <sub>FAULT</sub>	ms
			RSTR bits = 01		32 x t <sub>FAULT</sub>	
			RSTR bits = 10		64 x t <sub>FAULT</sub>	
			RSTR bits = 11		0	
Watchdog Clock Period	t <sub>WD</sub>	Rate of decrement of the watchdog timer		164		ms
<b>ADC PERFORMANCE</b>						
Resolution				9		Bits
Range				0.51		V
LSB Step Size				1		mV
Integral Nonlinearity (Relative)	INL			0.2	1.5	LSB

# High-Power, Quad, Monolithic, PSE Controllers for Power over Ethernet

MAX5965A/MAX5965B

## ELECTRICAL CHARACTERISTICS (continued)

(V<sub>AGND</sub> = 32V to 60V, V<sub>EE</sub> = 0V, V<sub>DD</sub> to V<sub>DGND</sub> = +3.3V, all voltages are referenced to V<sub>EE</sub>, unless otherwise noted. Typical values are at V<sub>AGND</sub> = +48V, V<sub>DGND</sub> = +48V, V<sub>DD</sub> = (V<sub>DGND</sub> + 3.3V), T<sub>A</sub> = +25°C. Currents are positive when entering the pin and negative otherwise.) (Note 2)

PARAMETER	SYMBOL	CONDITIONS	MIN	TYP	MAX	UNITS
Differential Nonlinearity	DNL			0.2	1.5	LSB
Gain Error					3	%
ADC Absolute Accuracy		V <sub>SENSE_</sub> = 300mV	295	300	305	LSB
<b>TIMING CHARACTERISTICS (For 2-Wire Fast Mode)</b>						
Serial-Clock Frequency	f <sub>SCL</sub>				400	kHz
Bus Free Time Between a STOP and START Condition	t <sub>BUF</sub>		1.2			μs
Hold Time for a START Condition	t <sub>HD, STA</sub>		0.6			μs
Low Period of the SCL Clock	t <sub>LOW</sub>		1.2			μs
High Period of the SCL Clock	t <sub>HIGH</sub>		0.6			μs
Setup Time for a Repeated START Condition (Sr)	t <sub>SU, STA</sub>		0.6			μs
Data Hold Time	t <sub>HD, DAT</sub>		100		300	ns
Data in Setup Time	t <sub>SU, DAT</sub>		100			ns
Rise Time of Both SDA and SCL Signals, Receiving	t <sub>R</sub>		20 + 0.1C <sub>B</sub>		300	ns
Fall Time of SDA Transmitting	t <sub>F</sub>		20 + 0.1C <sub>B</sub>		300	ns
Setup Time for STOP Condition	t <sub>SU, STO</sub>		0.6			μs
Capacitive Load for Each Bus Line	C <sub>B</sub>				400	pF
Pulse Width of Spike Suppressed	t <sub>SP</sub>				50	ns

**Note 2:** Limits to T<sub>A</sub> = -40°C are guaranteed by design.

**Note 3:** Default values. The charge/discharge currents are programmable through the serial interface (see the *Register Map and Description* section).

**Note 4:** Default values. The current-limit thresholds are programmed through the I<sup>2</sup>C-compatible serial interface (see the *Register Map and Description* section).

**Note 5:** Functional test is performed over thermal shutdown entering test mode.

**Note 6:** This is the default value. Threshold can be programmed through serial interface R23h[2:0].

**Note 7:** AC disconnect works only if (V<sub>DD</sub> - V<sub>DGND</sub>) ≥ 3V and DGND is connected to AGND.

**Note 8:** t<sub>DISC</sub> can also be programmed through the serial interface (R16h) (see the *Register Map and Description* section).

**Note 9:** R<sub>D</sub> = (V<sub>OUT\_2</sub> - V<sub>OUT\_1</sub>) / (I<sub>DET\_2</sub> - I<sub>DET\_1</sub>). V<sub>OUT\_1</sub>, V<sub>OUT\_2</sub>, I<sub>DET\_2</sub>, and I<sub>DET\_1</sub> represent the voltage at OUT\_ and the current at DET\_ during phase 1 and 2 of the detection.

**Note 10:** Default values. The startup and fault times can also be programmed through the I<sup>2</sup>C serial interface (see the *Register Map and Description* section).

# High-Power, Quad, Monolithic, PSE Controllers for Power over Ethernet

## Typical Operating Characteristics

( $V_{EE} = -48V$ ,  $V_{DD} = +3.3V$ ,  $V_{AUTO} = V_{AGND} = V_{DGND} = 0V$ ,  $\overline{RESET} = \overline{SHD\_} = \text{unconnected}$ ,  $R_{SENSE} = 0.5\Omega$ ,  $I_{VEE} = 00$ ,  $I_{CUT} = 000$ ,  $T_A = +25^\circ C$ , all registers = default setting, unless otherwise noted.)

**ANALOG SUPPLY CURRENT vs. INPUT VOLTAGE**

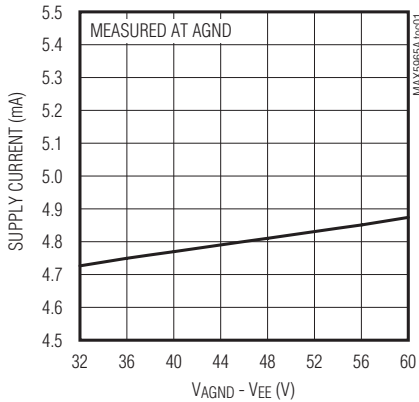

**ANALOG SUPPLY CURRENT vs. TEMPERATURE**

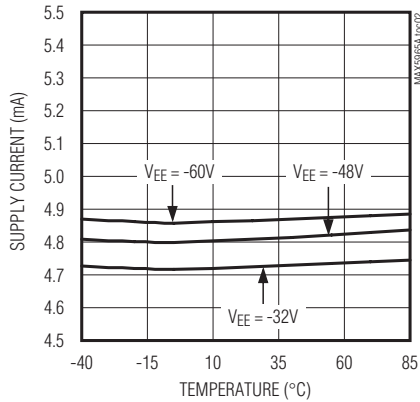

**DIGITAL SUPPLY CURRENT vs. TEMPERATURE**

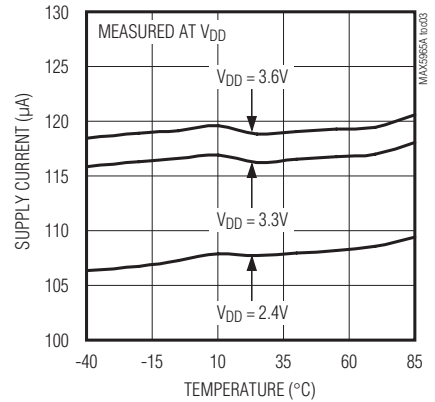

**DIGITAL SUPPLY CURRENT vs. DIGITAL SUPPLY VOLTAGE**

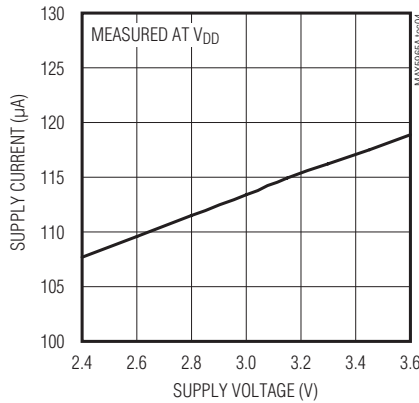

**VEE UNDERVOLTAGE LOCKOUT vs. TEMPERATURE**

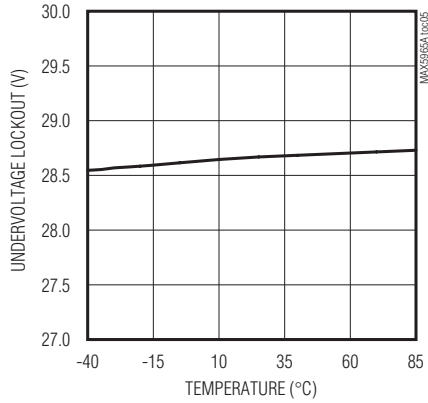

**GATE OVERDRIVE vs. INPUT VOLTAGE**

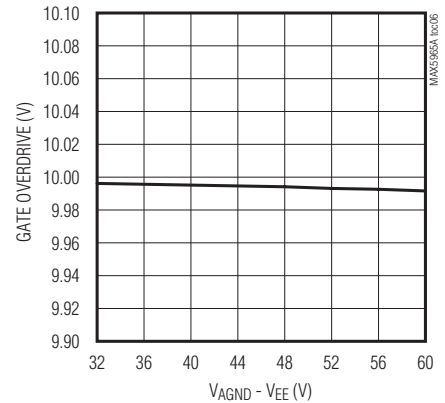

**GATE OVERDRIVE vs. TEMPERATURE**

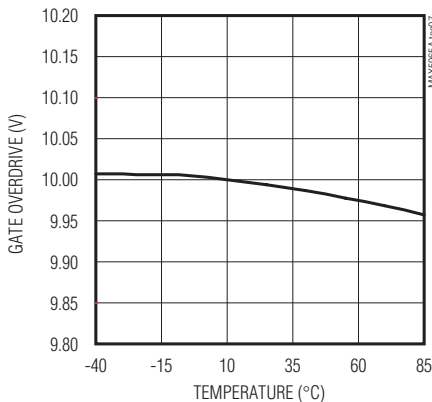

**SENSE TRIP VOLTAGE vs. TEMPERATURE**

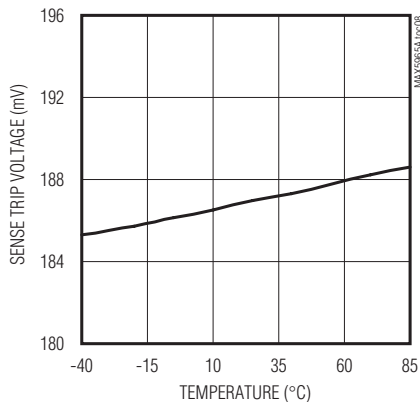

**SENSE TRIP VOLTAGE vs. INPUT VOLTAGE**

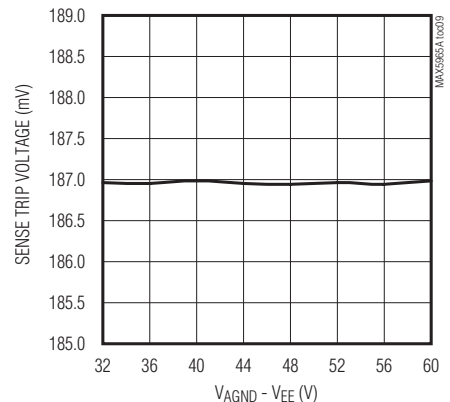

# High-Power, Quad, Monolithic, PSE Controllers for Power over Ethernet

MAX5965A/MAX5965B

## Typical Operating Characteristics (continued)

( $V_{EE} = -48V$ ,  $V_{DD} = +3.3V$ ,  $V_{AUTO} = V_{AGND} = V_{DGND} = 0V$ ,  $\overline{RESET} = \overline{SHD\_} = \text{unconnected}$ ,  $R_{SENSE} = 0.5\Omega$ ,  $I_{VEE} = 00$ ,  $I_{CUT} = 000$ ,  $T_A = +25^\circ C$ , all registers = default setting, unless otherwise noted.)

**FOLDBACK CURRENT-LIMIT THRESHOLD vs. OUTPUT VOLTAGE**

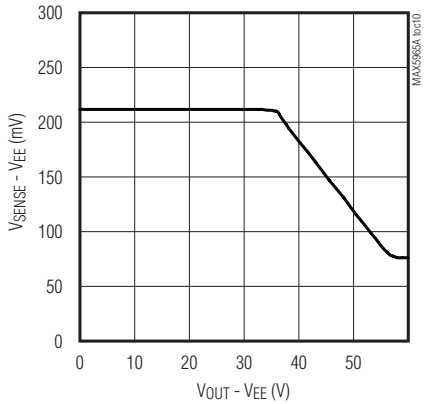

**FOLDBACK CURRENT-LIMIT THRESHOLD vs. OUTPUT VOLTAGE**

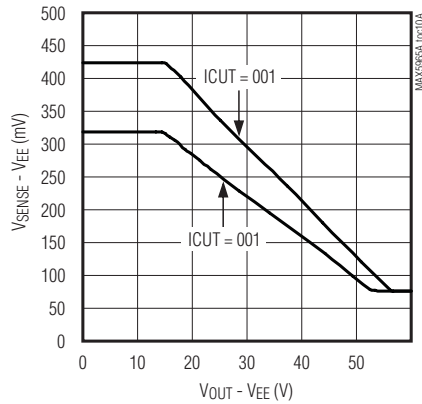

**DC LOAD DISCONNECT THRESHOLD vs. TEMPERATURE**

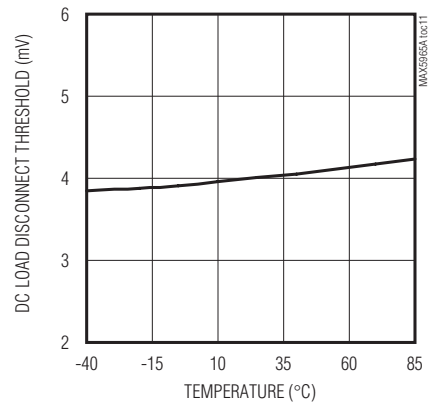

**OVERCURRENT TIMEOUT (R<sub>LOAD</sub> = 240Ω TO 57Ω)**

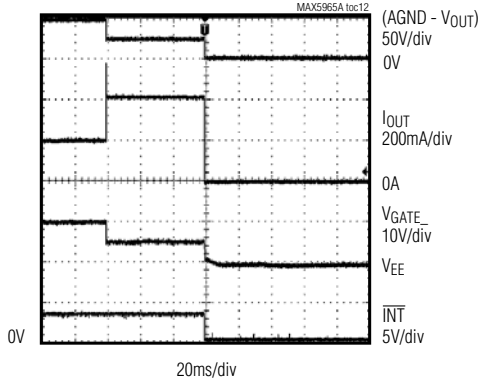

**OVERCURRENT RESPONSE WAVEFORM (MAX5965AUAX) (R<sub>LOAD</sub> = 240Ω TO 57Ω)**

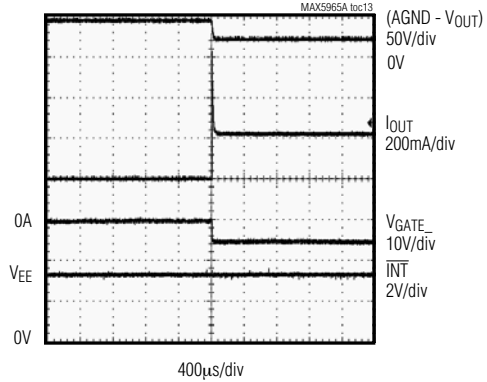

**SHORT-CIRCUIT RESPONSE TIME**

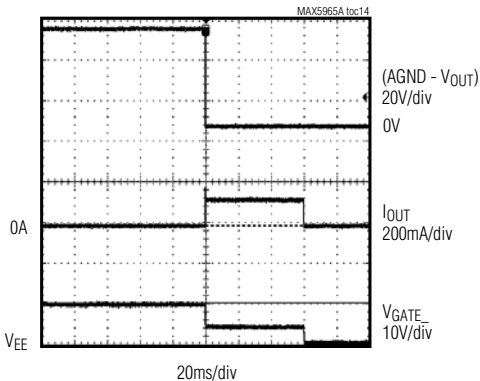

**SHORT-CIRCUIT RESPONSE TIME**

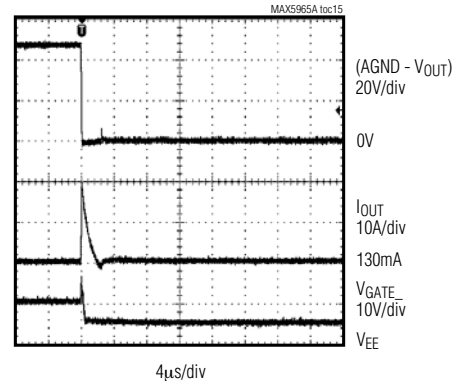

# High-Power, Quad, Monolithic, PSE Controllers for Power over Ethernet

## Typical Operating Characteristics (continued)

( $V_{EE} = -48V$ ,  $V_{DD} = +3.3V$ ,  $V_{AUTO} = V_{AGND} = V_{DGND} = 0V$ ,  $\overline{RESET} = \overline{SHD}_- = \text{unconnected}$ ,  $R_{SENSE} = 0.5\Omega$ ,  $I_{VEE} = 00$ ,  $ICUT = 000$ ,  $T_A = +25^\circ C$ , all registers = default setting, unless otherwise noted.)

**RESET TO OUT TURN-OFF DELAY**

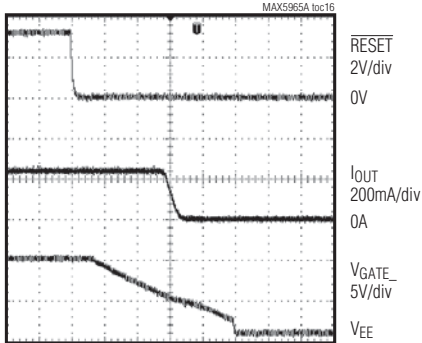

**ZERO-CURRENT DETECTION WAVEFORM**

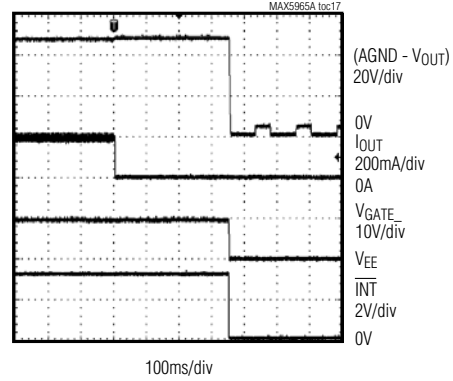

**OVERCURRENT RESTART DELAY**

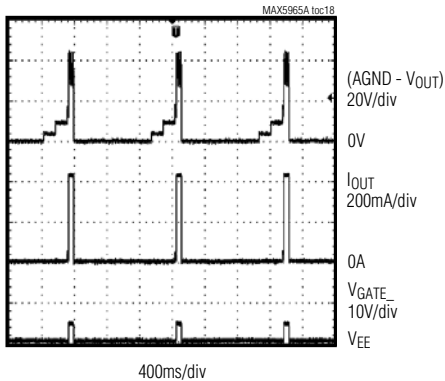

**STARTUP WITH VALID PD (25kΩ AND 0.1μF)**

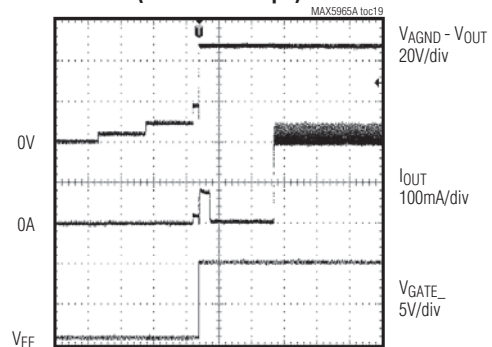

**DETECTION WITH INVALID PD (25kΩ AND 10μF)**

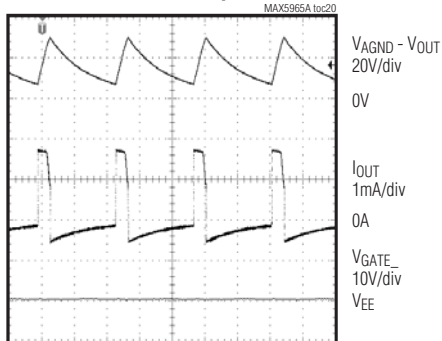

**DETECTION WITH INVALID PD (15kΩ)**

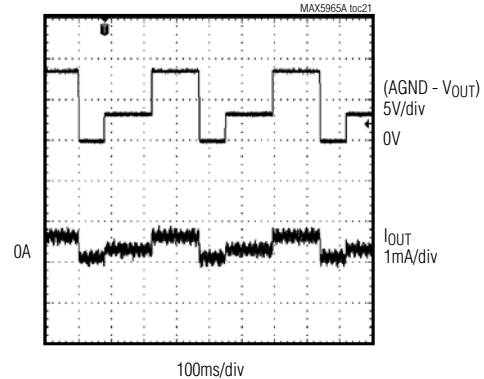

# High-Power, Quad, Monolithic, PSE Controllers for Power over Ethernet

## Typical Operating Characteristics (continued)

( $V_{EE} = -48V$ ,  $V_{DD} = +3.3V$ ,  $V_{AUTO} = V_{AGND} = V_{DGND} = 0V$ ,  $\overline{RESET} = \overline{SHD}_- = \text{unconnected}$ ,  $R_{SENSE} = 0.5\Omega$ ,  $I_{VEE} = 00$ ,  $ICUT = 000$ ,  $T_A = +25^\circ C$ , all registers = default setting, unless otherwise noted.)

MAX5965A/MAX5965B

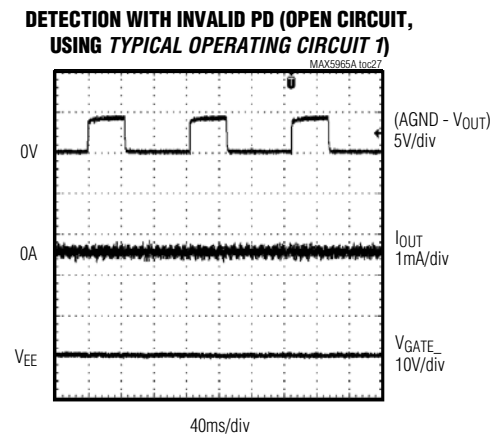
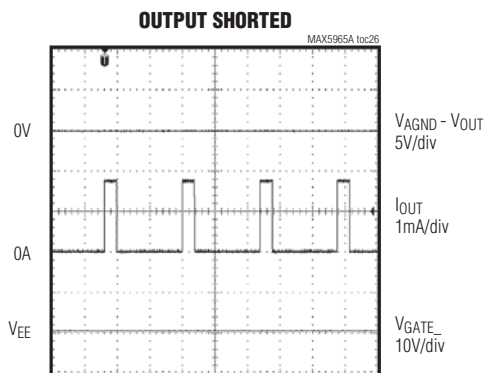
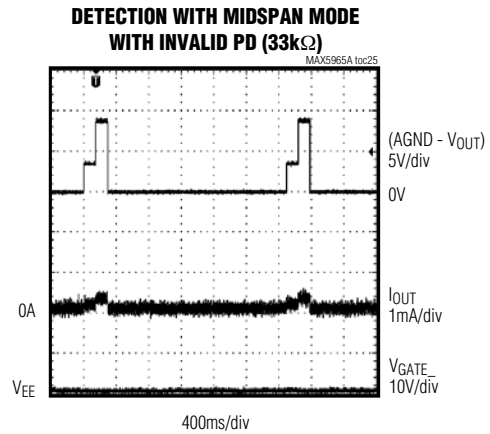
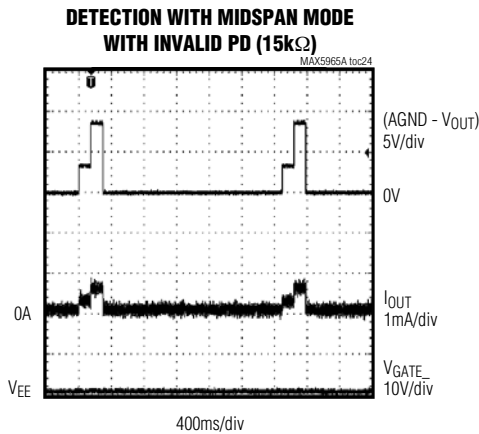
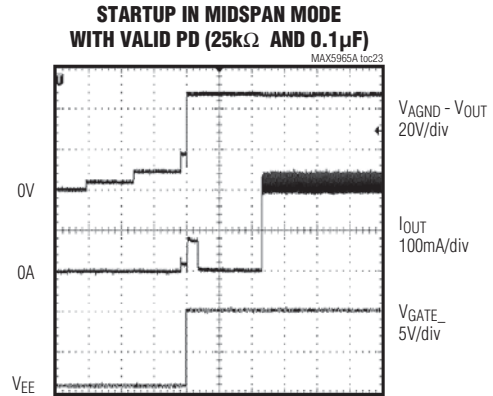
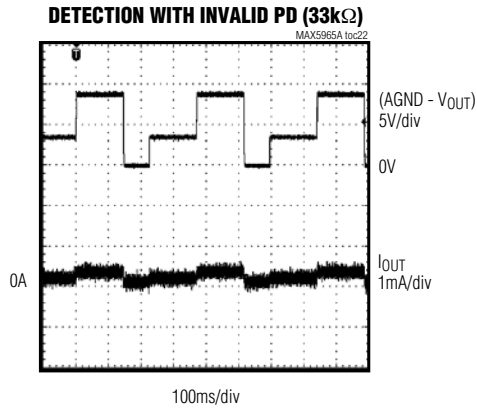

# High-Power, Quad, Monolithic, PSE Controllers for Power over Ethernet

## Typical Operating Characteristics (continued)

( $V_{EE} = -48V$ ,  $V_{DD} = +3.3V$ ,  $V_{AUTO} = V_{AGND} = V_{DGND} = 0V$ ,  $\overline{RESET} = \overline{SHD\_} = \text{unconnected}$ ,  $R_{SENSE} = 0.5\Omega$ ,  $I_{VEE} = 00$ ,  $I_{CUT} = 000$ ,  $T_A = +25^\circ C$ , all registers = default setting, unless otherwise noted.)

**DETECTION WITH INVALID PD (OPEN CIRCUIT, USING TYPICAL OPERATING CIRCUIT 2)**

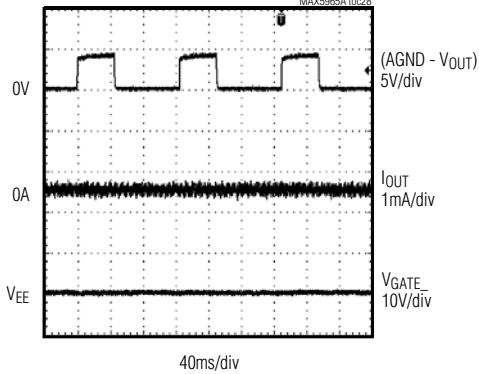

**STARTUP WITH DIFFERENT PD CLASSES**

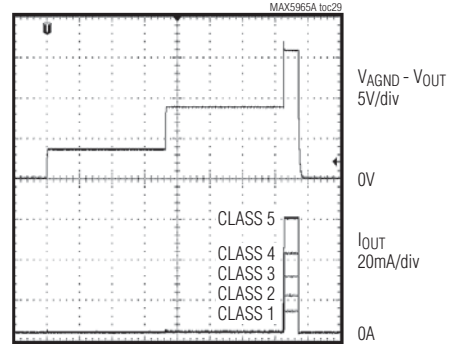

**2-EVENT CLASSIFICATION WITH A CLASS 4 PD**

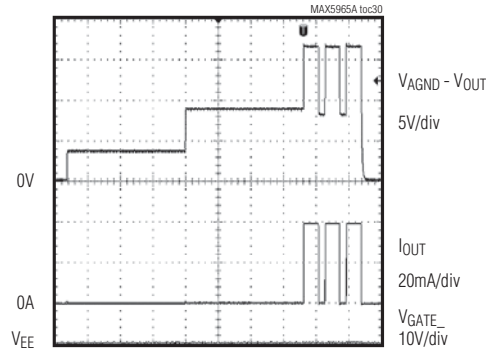

## Pin Description

PIN	NAME	FUNCTION
1	$\overline{RESET}$	Hardware Reset. Pull $\overline{RESET}$ low for at least 300 $\mu s$ to reset the device. All internal registers reset to their default value. The address (A0–A3), and AUTO and MIDSPAN input-logic levels latch on during low-to-high transition of $\overline{RESET}$ . $\overline{RESET}$ is internally pulled up to $V_{DD}$ with a 50k $\Omega$ resistor.
2	MIDSPAN	Midspan Mode Input. An internal 50k $\Omega$ pulldown resistor to DGND sets the default mode to endpoint PSE operation (power-over-signal pairs). Pull MIDSPAN to $V_{DIG}$ to set midspan operation. The MIDSPAN value latches after the device is powered up or reset (see the <i>PD Detection</i> section).
3	$\overline{INT}$	Open-Drain Interrupt Output. $\overline{INT}$ goes low whenever a fault condition exists. Reset the fault condition using software or by pulling $\overline{RESET}$ low (see the <i>Interrupt</i> section for more information about interrupt management).
4	SCL	Serial Interface Clock Line Input
5	SDAOUT	Serial Output Data Line. Connect the data line optocoupler input to SDAOUT (see the <i>Typical Operating Circuits</i> ). Connect SDAOUT to SDAIN if using a 2-wire, I <sup>2</sup> C-compatible system.

# High-Power, Quad, Monolithic, PSE Controllers for Power over Ethernet

## Pin Description (continued)

PIN	NAME	FUNCTION
6	SDAIN	Serial Interface Input Data Line. Connect the data line optocoupler output to SDAIN (see the <i>Typical Operating Circuits</i> ). Connect SDAIN to SDAOUT if using a 2-wire, I <sup>2</sup> C-compatible system.
7–10	A3–A0	Address Bits. A3–A0 form the lower part of the device's address. Address inputs default high with an internal 50k $\Omega$ pullup resistor to V <sub>DD</sub> . The address values latch when V <sub>DD</sub> or V <sub>EE</sub> ramps up and exceeds its UVLO threshold or after a reset. The 3 MSBs of the address are set to 010.
11–14	DET1–DET4	Detection/Classification Voltage Outputs. Use DET1 to set the detection and classification probe voltages on port 1. Use DET1 for the AC voltage sensing of port 1 when using the AC disconnect scheme (see the <i>Typical Operating Circuits</i> ).
15	DGND	Digital Ground. Connect to digital ground.
16	V <sub>DD</sub>	Positive Digital Supply. Connect to a digital power supply (reference to DGND).
17– 20	$\overline{\text{SHD1}}\text{--}\overline{\text{SHD4}}$	Port Shutdown Inputs. Pull $\overline{\text{SHD}}_n$ low to turn off the external FET on port <sub>n</sub> . Internally pulled up to V <sub>DD</sub> with a 50k $\Omega$ resistor.
21	AGND	Analog Ground. Connect to the high-side analog supply.
22, 25, 29, 32	SENSE4, SENSE3, SENSE2, SENSE1	MOSFET Source Current-Sense Negative Inputs. Connect to the source of the power MOSFET and connect a current-sense resistor between SENSE <sub>n</sub> and V <sub>EE</sub> (see the <i>Typical Operating Circuits</i> ).
23, 26, 30, 33	GATE4, GATE3, GATE2, GATE1	Port <sub>n</sub> MOSFET Gate Drivers. Connect GATE <sub>n</sub> to the gate of the external MOSFET (see the <i>Typical Operating Circuits</i> ).
24, 27, 31, 34	OUT4, OUT3, OUT2, OUT1	MOSFET Drain-Output Voltage Senses. Connect OUT <sub>n</sub> to the power MOSFET drain through a resistor (100 $\Omega$ to 100k $\Omega$ ). The low leakage at OUT <sub>n</sub> limits the drop across the resistor to less than 100mV (see the <i>Typical Operating Circuits</i> ).
28	V <sub>EE</sub>	Low-Side Analog Supply Input. Connect the low-side analog supply to V <sub>EE</sub> (-48V). Bypass with a 1 $\mu$ F capacitor between AGND and V <sub>EE</sub> .
35	AUTO	Auto or Shutdown Mode Input. Force AUTO high to enter auto mode after a reset or power-up. Drive low to put the MAX5965A/MAX5965B into shutdown mode. In shutdown mode, software controls the operational modes of the MAX5965A/MAX5965B. A 50k $\Omega$ internal pulldown resistor defaults to AUTO low. AUTO latches when V <sub>DD</sub> or V <sub>EE</sub> ramps up and exceeds its UVLO threshold or when the device resets. Software commands can take the MAX5965A/MAX5965B out of AUTO while AUTO is high.
36	OSC	Oscillator Input. AC-disconnect detection function uses OSC. Connect a 100Hz $\pm$ 10%, 2V <sub>P-P</sub> $\pm$ 5%, +1.3V offset sine wave to OSC. If the oscillator positive peak falls below the OSC_FAIL threshold of 2V, the ports that have the AC function enabled shut down and are not allowed to power-up. When not using the AC-disconnect detection function, leave OSC unconnected.

MAX5965A/MAX5965B

# High-Power, Quad, Monolithic, PSE Controllers for Power over Ethernet

MAX5965A/MAX5965B

## Functional Diagram

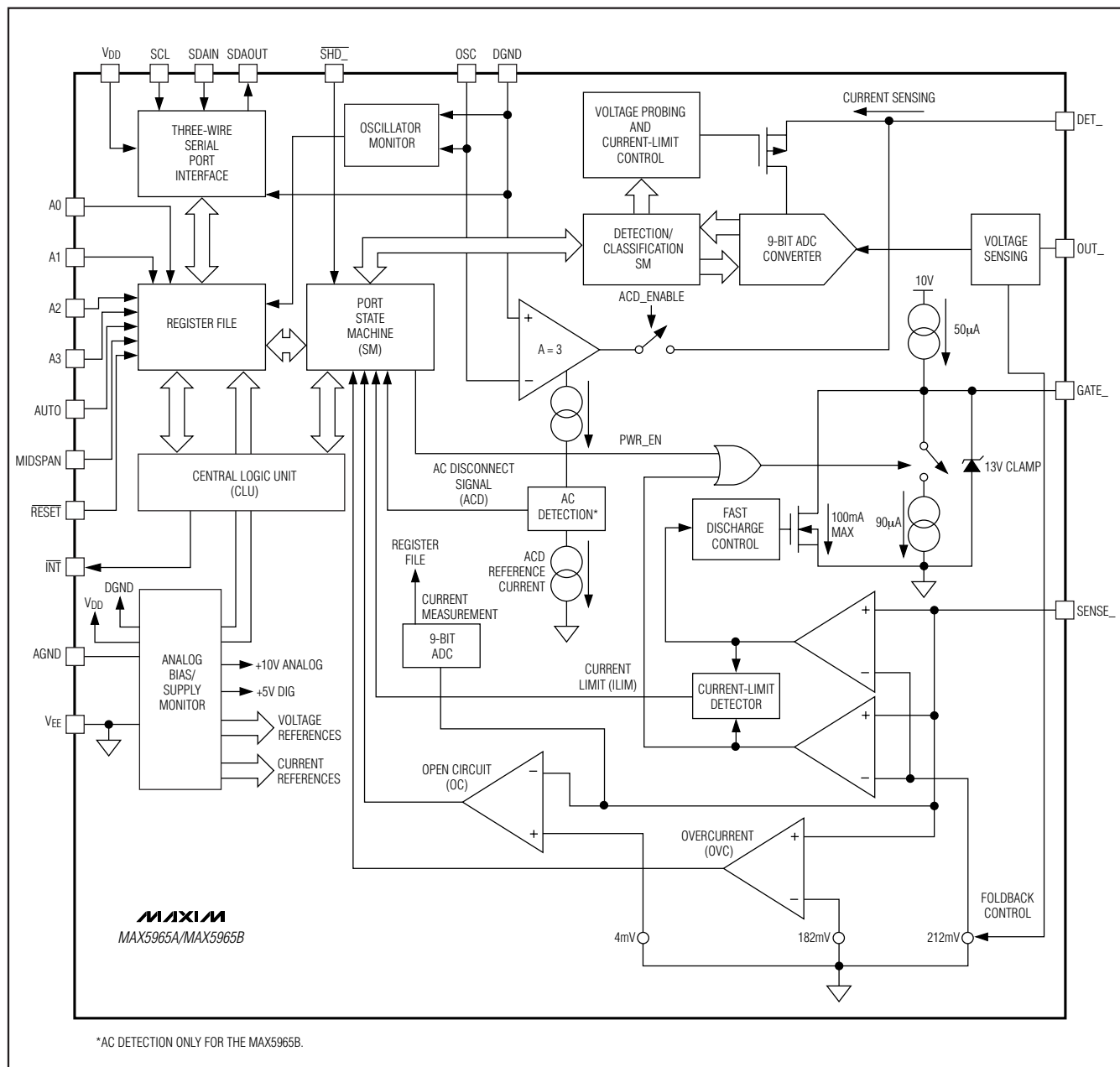

# High-Power, Quad, Monolithic, PSE Controllers for Power over Ethernet

MAX5965A/MAX5965B

## Detailed Description

The MAX5965A/MAX5965B are quad -48V power controllers designed for use in IEEE 802.3af-compliant/pre-IEEE 802.3at-compatible PSE. The devices provide PD discovery, classification, current limit, DC and AC load disconnect detections in compliance with the IEEE 802.3af standard. The MAX5965A/MAX5965B are pin compatible with the MAX5952/MAX5945/LTC4258/LTC4259A PSE controllers and provides additional features.

The MAX5965A/MAX5965B feature a high-power mode, which provides up to 45W per port. The devices allow the user to program the current-limit and overcurrent thresholds up to 2.5 times the default thresholds. The MAX5965A/MAX5965B can also be programmed to decrease the current-limit and overcurrent threshold by 15% for high operating voltage conditions to keep the output power constant.

The MAX5965A/MAX5965B provide new Class 5 and 2-event classification (Class 6) for detection and classification of high-power PDs. The MAX5965A/MAX5965B provide instantaneous readout of each port current through the I<sup>2</sup>C interface. The MAX5965A/MAX5965B also provide high-capacitance detection for legacy PDs.

The MAX5965A/MAX5965B are fully software configurable and programmable through an I<sup>2</sup>C-compatible, 3-wire serial interface with 49 registers. The class-overcurrent detection function enables system power management to detect if a PD draws more than the allowable current. The MAX5965A/MAX5965B's extensive programmability enhances system flexibility, enables field diagnosis, and allows for uses in other applications.

The MAX5965A/MAX5965B provide four operating modes to suit different system requirements. Auto mode allows the device to operate automatically without any software supervision. Semi-auto mode automatically detects and classifies a device connected to a port after initial software activation but does not power up that port until instructed to by software. Manual mode allows total software control of the device and is useful for system diagnostics. Shutdown mode terminates all activities and securely turns off power to the ports.

The MAX5965A/MAX5965B provide input undervoltage lockout, input undervoltage detection, a load-stability safety check during detection, input overvoltage lockout, overtemperature detection, output voltage slew-rate limit during startup, power-good, and fault status. The MAX5965A/MAX5965B's programmability includes start-up timeout, overcurrent timeout, and load-disconnect detection timeout.

The MAX5965A/MAX5965B communicate with the system microcontroller through an I<sup>2</sup>C-compatible interface. The MAX5965A/MAX5965B feature separate input and output data lines (SDAIN and SDAOUT) for use with optocoupler isolation. As slave devices, the MAX5965A/MAX5965B include four address inputs allowing 16 unique addresses. A separate  $\overline{\text{INT}}$  output and four independent shutdown inputs ( $\overline{\text{SHD}}_n$ ) provide fast response from a fault to port shutdown between the MAX5965A/MAX5965B and the microcontroller. A  $\overline{\text{RESET}}$  input allows hardware reset of the device.

### Reset

Reset is a condition the MAX5965A/MAX5965B enter after any of the following conditions:

- 1) After power-up ( $V_{EE}$  and  $V_{DD}$  rise above their UVLO thresholds).
- 2) Hardware reset. The  $\overline{\text{RESET}}$  input is driven low and back high again any time after power-up.
- 3) Software reset. Writing a 1 into R1Ah[4] any time after power-up.
- 4) Thermal shutdown.

During a reset, the MAX5965A/MAX5965B reset their register map to the reset state as shown in Table 37 and latch in the state of AUTO (pin 35) and MIDSPAN (pin 2). During normal operation, change at the AUTO and MIDSPAN input is ignored. While the condition that caused the reset persists (i.e. high temperature,  $\overline{\text{RESET}}$  input low, or UVLO conditions) the MAX5965A/MAX5965B do not acknowledge any addressing from the serial interface.

### Port Reset (R1Ah[3:0])

Set high anytime during normal operation to turn off power and clear the events and status registers of the corresponding port. Port reset only resets the events and status registers.

### Midspan Mode

In midspan mode, the device adopts cadence timing during the detection phase. When cadence timing is enabled and a failed detection occurs, the port waits between 2s and 2.4s before attempting to detect again. Midspan mode is activated by setting R11h[1] high. The status of the MIDSPAN pin is written to R11h[1] during power-up or after a reset. MIDSPAN is internally pulled low by a 50k $\Omega$  resistor.

# High-Power, Quad, Monolithic, PSE Controllers for Power over Ethernet

## Operation Modes

The MAX5965A/MAX5965B contain four independent, but identical state machines to provide reliable and real-time control of the four network ports. Each state machine has four operating modes: auto mode, semi-auto mode, manual, and shutdown. Auto mode allows the device to operate automatically without any software supervision. Semi-auto mode, upon request, continuously detects and classifies a device connected to a port but does not power up that port until instructed by software. Manual mode allows total software control of the device and is useful in system diagnostics. Shutdown mode terminates all activities and securely turns off power to the ports.

Switching between auto, semi, or manual mode does not interfere with the operation of the port. When the port is set into shutdown mode, all the port operations are immediately stopped and the port remains idle until shutdown is exited.

### Automatic (Auto) Mode

Enter automatic (auto) mode by forcing the AUTO input high prior to a reset, or by setting R12h[P\_M1,P\_M0] to [1,1] during normal operation (see Tables 16a and 16b). In auto mode, the MAX5965A/MAX5965B performs detection, classification, and power up the port automatically once a valid PD is detected at the port. If a valid PD is not connected at the port, the MAX5965A/MAX5965B repeat the detection routine continuously until a valid PD is connected.

Going into auto mode, the DET\_EN\_ and CLASS\_EN\_ bits are set to high and stay high unless changed by software. Using software to set DET\_EN\_ and/or CLASS\_EN\_ low causes the MAX5965A/MAX5965B to skip detection and/or classification. As a protection, disabling the detection routine in auto mode does not allow the corresponding port to power up, unless the DET\_BY (R23h[4]) is set to 1.

The AUTO status is latched into the register only during a reset. Any changes to the AUTO input after reset are ignored.

### Semi-Automatic (Semi-Auto) Mode

Enter semi-auto mode by setting R12h[P\_M1,P\_M0] to [1,0] during normal operation (see Tables 16a and 16b). In semi-auto mode, the MAX5965A/MAX5965B, upon request, perform detection and/or classification repeatedly but do not power up the port(s), regardless of the status of the port connection.

Setting R19h[PWR\_ON\_] (Table 22) high immediately terminates detection/classification routines and turns on power to the port(s).

R14h[DET\_EN\_, CLASS\_EN\_] default to low in semi-auto mode. Use software to set R14h[DET\_EN\_, CLASS\_EN\_] to high to start the detection and/or classification routines. R14h[DET\_EN\_, CLASS\_EN\_] are reset every time the software commands a power off of the port (either through reset or PWR\_OFF\_). In any other case, the status of the bits is left unchanged (including when the state machine turns off the power because a load disconnect or a fault condition is encountered).

### Manual Mode

Enter manual mode by setting R12h[P\_M1,P\_M0] to [0,1] during normal operation (see Tables 16a and 16b). Manual mode allows the software to dictate any sequence of operation. Write a 1 to both R14h[DET\_EN\_] and R14h[CLASS\_EN\_] to start detection and classification operations, respectively, and in that priority order. After execution, the command is cleared from the register(s). PWR\_ON\_ has highest priority. Setting PWR\_ON\_ high at any time causes the device to immediately enter the powered mode. Setting DET\_EN\_ and CLASS\_EN\_ high at the same time causes detection to be performed first. Once in the powered state, the device ignores DET\_EN\_ or CLASS\_EN\_ commands.

When switching to manual mode from another mode, DET\_EN\_, CLASS\_EN\_ default to low. These bits become pushbutton rather than configuration bits (i.e., writing ones to these bits while in manual mode commands the device to execute one cycle of detection and/or classification. The bits are reset back to zeros at the end of the execution).

### Shutdown Mode

Enter shutdown mode by forcing the AUTO input low prior to a reset, or by setting R12h[P\_M1,P\_M0] to [0,0] during normal operation (see Tables 16a and 16b). Putting the MAX5965A/MAX5965B into shutdown mode immediately turns off power and halts all operations to the corresponding port. The event and status bits of the affected port(s) are also cleared. In shutdown mode, the DET\_EN\_, CLASS\_EN\_, and PWR\_ON\_ commands are ignored.

In shutdown mode, the serial interface operates normally.

### PD Detection

When PD detection is activated, the MAX5965A/MAX5965B probe the output for a valid PD. After each detection cycle, the device sets the DET\_END\_ bit R04h/05h[3:0] high and reports the detection results in the status registers R0Ch[2:0], R0Dh[2:0], R0Eh[2:0], and R0Fh[2:0]. The DET\_END\_ bit is reset to low when read through R05h or after a port reset.

# High-Power, Quad, Monolithic, PSE Controllers for Power over Ethernet

A valid PD has a 25k $\Omega$  discovery signature characteristic as specified in the IEEE 802.3af/at standard. Table 1 shows the IEEE 802.3af/at specification for a PSE detecting a valid PD signature. See the *Typical Operating Circuits* and Figure 1a (Detection, Classification, and Power-Up Port Sequence). The MAX5965A/MAX5965B can probe and categorize different types of devices connected to the port such as: a valid PD, an open circuit, a low resistive load, a high resistive load, a high capacitive load, a positive DC supply, or a negative DC supply.

During detection, the MAX5965A/MAX5965B keep the external MOSFET off and force two probe voltages through the DET\_ input. The current through the DET\_ input is measured as well as the voltage at OUT\_. A two-point slope measurement is used as specified by the IEEE 802.3af standard to verify the device connected to the port. The MAX5965A/MAX5965B implement appropriate settling times and a 100ms digital integration to reject 50Hz/60Hz power-line noise coupling.

An external diode, in series with the DET\_ input, restricts PD detection to the first quadrant as specified by the IEEE 802.3af/at standard. To prevent damage to non-PD devices, and to protect themselves from an output short circuit, the MAX5965A/MAX5965B limit the current into DET\_ to less than 2mA maximum during PD detection.

In midspan mode, the MAX5965A/MAX5965B wait 2.2s before attempting another detection cycle after every failed detection. The first detection, however, happens immediately after issuing the detection command.

### High-Capacitance Detection

The CLC\_EN bit in register R23h[5] enables the large capacitor detection feature for legacy PD devices. When CLC\_EN = 1, the high-capacitance detection limit is extended up to 150 $\mu$ F. CLC\_EN = 0 is the default condition for the normal capacitor size detection. See Table 1 and the *Register Map and Description* section.

**Table 1. PSE PI Detection Modes Electrical Requirement  
(Table 33-2 of the IEEE 802.3af Standard)**

PARAMETER	SYMBOL	MIN	MAX	UNITS	ADDITIONAL INFORMATION
Open-Circuit Voltage	V <sub>OC</sub>	—	30	V	In detection mode only
Short-Circuit Current	I <sub>SC</sub>	—	5	mA	In detection mode only
Valid Test Voltage	V <sub>VALID</sub>	2.8	10	V	
Voltage Difference Between Test Points	$\Delta$ V <sub>TEST</sub>	1	—	V	
Time Between Any Two Test Points	t <sub>BP</sub>	2	—	ms	This timing implies a 500Hz maximum probing frequency
Slew Rate	V <sub>SLEW</sub>		0.1	V/ $\mu$ s	
Accept Signature Resistance	R <sub>GOOD</sub>	19	26.5	k $\Omega$	
Reject Signature Resistance	R <sub>BAD</sub>	< 15	> 33	k $\Omega$	
Open-Circuit Resistance	R <sub>OPEN</sub>	500	—	k $\Omega$	
Accept Signature Capacitance	C <sub>GOOD</sub>	—	150	nF	
Reject Signature Capacitance	C <sub>BAD</sub>	10	—	$\mu$ F	
Signature Offset Voltage Tolerance	V <sub>OS</sub>	0	2.0	V	
Signature Offset Current Tolerance	I <sub>OS</sub>	0	12	$\mu$ A	

# High-Power, Quad, Monolithic, PSE Controllers for Power over Ethernet

## Powered Device Classification (PD Classification)

During the PD classification mode, the MAX5965A/MAX5965B force a probe voltage (-18V) at DET<sub>-</sub> and measure the current into DET<sub>-</sub>. The measured current determines the class of the PD.

After each classification cycle, the device sets the CL\_END<sub>-</sub> bit (R04h/05h[7:4]) high and reports the classification results in the status registers R0Ch[6:4], R0Dh[6:4], R0Eh[6:4], and R0Fh[6:4]. The CL\_END<sub>-</sub> bit is reset to low when read through register R05h or after a port reset. Both event registers, R04h, and R05h are cleared after the port powers down. Table 2 shows the IEEE 802.3af requirement for a PSE classifying a PD at the power interface (PI).

The MAX5965A/MAX5965B support high power beyond the IEEE 802.3af standard by providing additional classifications (Class 5 and 2-event classification).

### Class 5 PD Classification

During classification, if the MAX5965A/MAX5965B detect currents in excess of ICLASS > 48mA, then the PD will be classified as a Class 5 powered device. Status registers R0Ch[6:4] or R0Dh[6:4] or R0Eh[6:4] or R0Fh[6:4] will report the Class 5 classification result.

### 2-Event (Class 6) PD Classification

When 2-event classification is activated, the classification cycle is repeated three times with 8ms wait time between each cycle (see Figure 1b). Between each classification cycle, the MAX5965A/MAX5965B do not reset the port voltage completely but keeps the output

voltage at -9V. The EN\_CL6 bits in R1Ch[7:4] enable 2-event classification on a per port basis.

## Powered State

When the MAX5965A/MAX5965B enter a powered state, the tSTART and tDISC timers are reset. Before turning on the port power, the MAX5965A/MAX5965B check if any other port is not turning on and if the tFAULT timer is zero. Another check is performed if the ACD\_EN<sub>-</sub> bit is set, in this case the OSC\_FAIL bit must be low (oscillator is okay) for the port to be powered.

If these conditions are met, the MAX5965A/MAX5965B enter startup where it turns on power to the port. An internal signal, POK<sub>-</sub>, asserts high when VOUT<sub>-</sub> is within 2V from VEE. PGOOD<sub>-</sub> status bits are set high if POK<sub>-</sub> stays high longer than tPGOOD. PGOOD<sub>-</sub> immediately resets when POK<sub>-</sub> goes low (see Figure 2).

The PG\_CHG<sub>-</sub> bit sets when a port powers up or down. PWR\_EN<sub>-</sub> sets when a port powers up and resets when a port shuts down. The port shutdown timer lasts 0.5ms and prevents other ports from turning off during that period, except in the case of emergency shutdowns (RESET = L, RESET\_IC = H, VEEUVLO, VDDUVLO, and TSHD).

The MAX5965A/MAX5965B always check the status of all ports before turning off. A priority logic system determines the order to prevent the simultaneous turn-on or turn-off of the ports. The port with the lesser ordinal number gets priority over the others (i.e., port 1 turns on first, port 2 second, port 3 third, and port 4 fourth). Setting PWR\_OFF<sub>-</sub> high turns off power to the corresponding port.

**Table 2. PSE Classification of a PD (Table 33-4 of the IEEE 802.3af)**

MEASURED ICLASS (mA)	CLASSIFICATION
0 to 5	Class 0
> 5 and < 8	May be Class 0 and 1
8 to 13	Class 1
> 13 and < 16	May be Class 1 or 2
16 to 21	Class 2
> 21 and < 25	May be Class 2 or 3
25 to 31	Class 3
> 31 and < 35	May be Class 3 or 4
35 to 45	Class 4
> 45 and < 51	May be Class 4 or 5
51 to 68	Class 5

# High-Power, Quad, Monolithic, PSE Controllers for Power over Ethernet

MAX5965A/MAX5965B

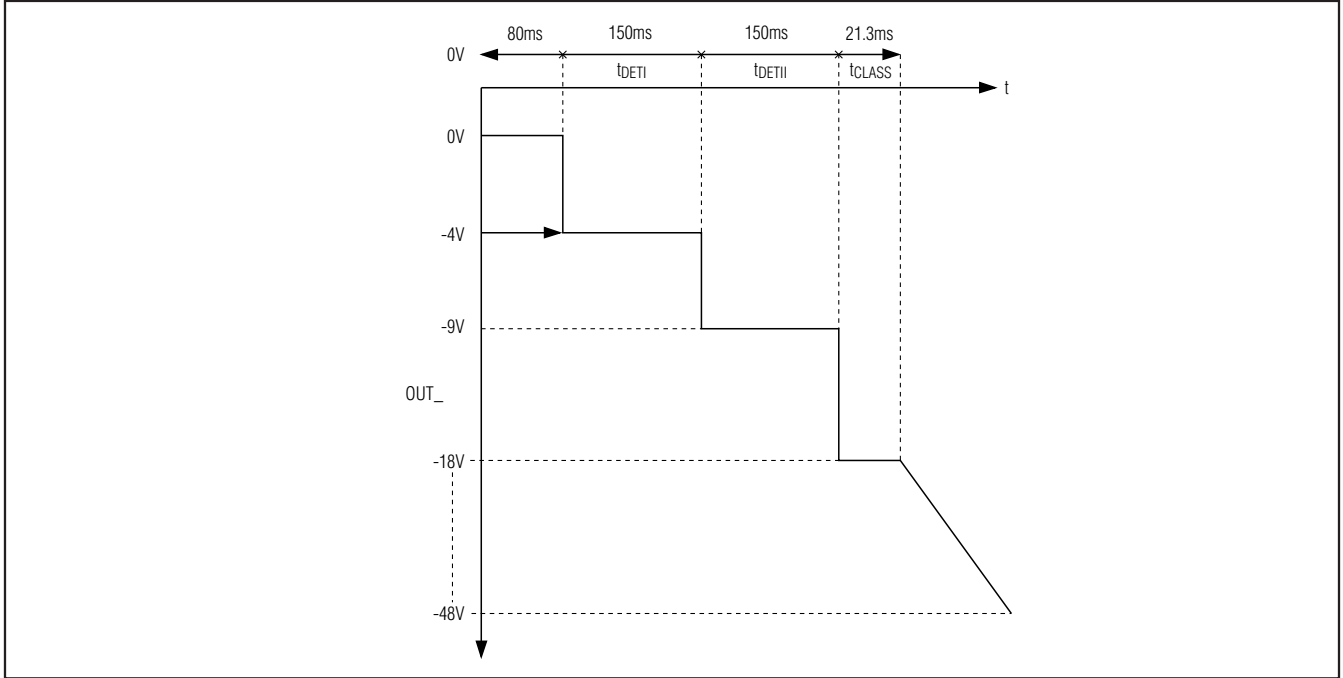

Figure 1a. Detection, Classification, and Power-Up Port Sequence

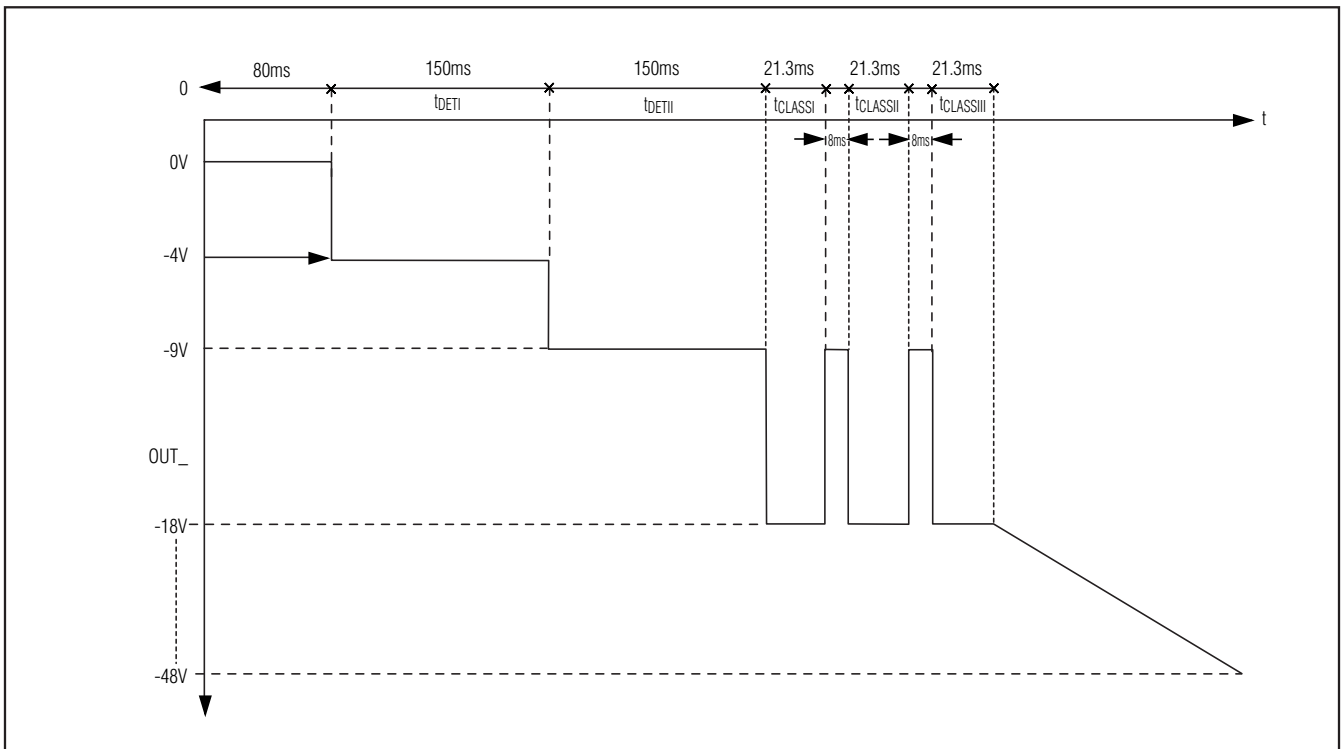

Figure 1b. Detection, 2-Event Classification, and Power-Up Port Sequence

# High-Power, Quad, Monolithic, PSE Controllers for Power over Ethernet

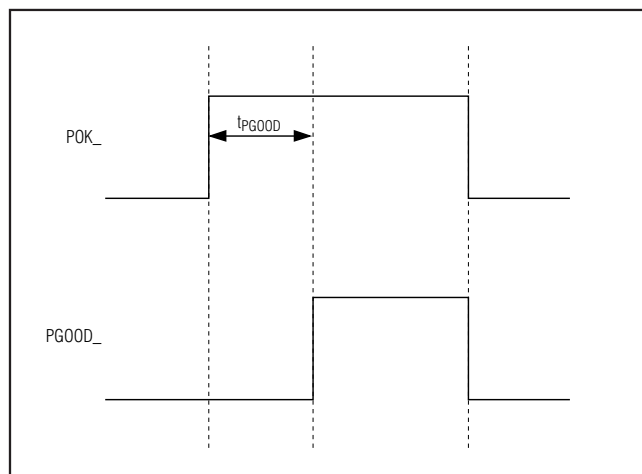

Figure 2. PGOOD\_ Timing

## Overcurrent Protection

A sense resistor  $R_S$  connected between SENSE\_ and VEE monitors the load current. Under normal operating conditions, the voltage across  $R_S$  ( $V_{RS}$ ) never exceeds the threshold  $V_{SU\_LIM}$ . If  $V_{RS}$  exceeds  $V_{SU\_LIM}$ , an internal current-limiting circuit regulates the GATE\_ voltage, limiting the current to  $I_{LIM} = V_{SU\_LIM}/R_S$ . During transient conditions, if  $V_{RS}$  exceeds  $V_{SU\_LIM}$  by more than 1V, a fast pulldown circuit activates to quickly recover from the current overshoot. During startup, if the current-limit condition persists, when the startup timer,  $t_{START}$ , times out, the port shuts off, and the STRT\_FLT\_ bit is set. In the normal powered state, the MAX5965A/MAX5965B check for overcurrent conditions as determined by  $V_{FLT\_LIM} = \sim 88\%$  of  $V_{SU\_LIM}$ . The  $t_{FAULT}$  counter sets the maximum allowed continuous overcurrent period. The  $t_{FAULT}$  counter increases when  $V_{RS}$  exceeds  $V_{FLT\_LIM}$  and decreases at a slower pace when  $V_{RS}$  drops below  $V_{FLT\_LIM}$ . A slower decrement for the  $t_{FAULT}$  counter allows for detecting repeated short-duration overcurrents. When the counter reaches the  $t_{FAULT}$  limit, the MAX5965A/MAX5965B power off the port and assert the IMAX\_FLT\_ bit. For a continuous overstress, a fault latches exactly after a period of  $t_{FAULT}$ .  $V_{SU\_LIM}$  is programmable through the ICUT registers R2Ah[6:4], R2Ah[2:0], R2Bh[6:4], R2Bh[2:0], and the IVEE bits in register R29h[1:0]. See the *High-Power Mode* section for more information on the ICUT register.

After power-off due to an overcurrent fault, and if the RSTR\_EN bit is set, the  $t_{FAULT}$  timer is not immediately reset but starts decrementing at the same slower pace. The MAX5965A/MAX5965B allow the port to be powered on only when the  $t_{FAULT}$  counter is at zero. This feature sets an automatic duty-cycle protection to the external MOSFET avoiding overheating.

The MAX5965A/MAX5965B continuously flag when the current exceeds the maximum current allowed for the class as indicated in the CLASS status register. When class overcurrent occurs, the MAX5965A/MAX5965B set the IVC\_ bit in register R09h.

## ICUT Register and High-Power Mode

### ICUT Register

The ICUT register determines the maximum current limits allowed for each port of the MAX5965A/MAX5965B. The 3 ICUT bits (R2Ah[6:4], R2Ah[2:0], R2Bh[6:4], and R2Bh[2:0]) allow programming of the current-limit and overcurrent thresholds in excess of the IEEE standard limit (see Tables 34a, 34b, and 34c). The ICUT registers can be written to directly through the I<sup>2</sup>C interface when CL\_DISC (R17h[2]) is set to 0 (see Table 3). In this case, the current limit of the port is configured regardless of the status of the classification.

By setting the CL\_DISC bit to 1, the MAX5965A/MAX5965B automatically set the ICUT register based upon the classification result of the port. See Table 3 and the *Register Map and Description* section.

### High-Power Mode

When CL\_DISC (R17h[2]) is set to 0, high-power mode is configured by setting the ICUT bits to any combination other than 000, 110, or 111 (note that 000 is the default value for the IEEE standard limit). See Table 3 and the *Register Map and Description* section.

### Foldback Current

During startup and normal operation, an internal circuit senses the voltage at OUT\_ and reduces the current-limit value when  $(V_{OUT\_} - V_{EE}) > 28V$ . The foldback function helps to reduce the power dissipation on the FET. The current limit eventually reduces down to 1/3 of  $I_{LIM}$  when  $(V_{OUT\_} - V_{EE}) > 48V$  (see Figure 3a). For high-power mode, the foldback starts when  $(V_{OUT\_} - V_{EE}) > 10V$  (see Figure 3b). In high-power mode, the current limit ( $I_{LIM}$ ) is reduced down to minimum foldback current ( $V_{TH\_FB}/R_S$ ) when  $(V_{OUT\_} - V_{EE}) > 48V$ .

# High-Power, Quad, Monolithic, PSE Controllers for Power over Ethernet

MAX5965A/MAX5965B

Table 3. Automatic ICUT Programming

CL_DISC	PORT CLASSIFICATION RESULT	ENx_CL6	EN_HP_ALL	EN_HP_CL6	EN_HP_CL5	EN_HP_CL4	RESULTING ICUT REGISTER BITS
0	Any	X	X	X	X	X	User programmed
1	1	X	X	X	X	X	ICUT = 110
1	2	X	X	X	X	X	ICUT = 111
1	0, 3	X	X	X	X	X	ICUT = 000
1	4, 5	X	0	X	X	X	ICUT = 000
1	5	X	1	X	1	X	ICUT = R24h[6:4]
1	5	X	1	X	0	X	ICUT = 000
1	4	X	1	X	x	1	ICUT = R24h[6:4]
1	4	X	1	X	X	0	ICUT = 000
1	6 or Illegal	0	X	X	X	X	—
1	6 or Illegal	1	1	1	X	X	(See Table 35a)
1	6 or Illegal	1	1	0	X	X	ICUT = 000
1	6 or Illegal	1	0	X	X	X	ICUT = 000

### MOSFET Gate Driver

Connect the gate of the external n-channel MOSFET to GATE\_. An internal 50µA current source pulls GATE\_ to (V<sub>EE</sub> + 10V) to turn on the MOSFET. An internal 40µA current source pulls down GATE\_ to V<sub>EE</sub> to turn off the MOSFET.

The pullup and pulldown current controls the maximum slew rate at the output during turn-on or turn-off. Use the following equation to set the maximum slew rate:

$$\frac{\Delta V_{OUT}}{\Delta t} = \frac{I_{GATE}}{C_{GD}}$$

where C<sub>GD</sub> is the total capacitance between GATE and DRAIN of the external MOSFET. Current limit and the capacitive load at the drain control the slew rate during startup. During current-limit regulation, the MAX5965A/MAX5965B manipulate the GATE\_ voltage to control the voltage at SENSE\_ (V<sub>RS</sub>). A fast pulldown activates if V<sub>RS</sub> overshoots the limit threshold (V<sub>SU\_LIM</sub>). The fast pulldown current increases with the amount of overshoot. The maximum fast pulldown current is 100mA.

During turn-off, when the GATE\_ voltage reaches a value lower than 1.2V, a strong pulldown switch is activated to keep the MOSFET securely off.

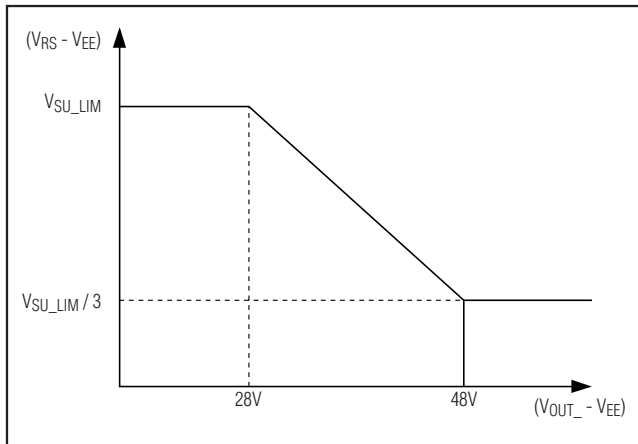

Figure 3a. Foldback Current Characteristics

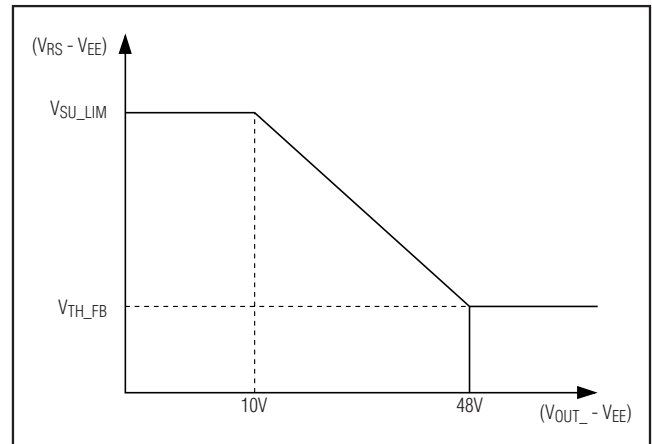

Figure 3b. Foldback Current Characteristics for High-Power Mode

# High-Power, Quad, Monolithic, PSE Controllers for Power over Ethernet

## Digital Logic

$V_{DD}$  supplies power for the internal logic circuitry.  $V_{DD}$  ranges from +3.0V to +5.5V and determines the logic thresholds for the CMOS connections (SDAIN, SDAOUT, SCL, AUTO,  $\overline{\text{SHD}}_-$ , A $_-$ ). This voltage range enables the MAX5965A/MAX5965B to interface with a nonisolated low-voltage microcontroller. The MAX5965A/MAX5965B check the digital supply for compatibility with the internal logic. The MAX5965A/MAX5965B also feature a  $V_{DD}$  undervoltage lockout ( $V_{DDUVLO}$ ) of +2.0V. A  $V_{DDUVLO}$  condition keeps the MAX5965A/MAX5965B in reset and the ports shut off. Bit 0 in the supply event register shows the status of  $V_{DDUVLO}$  (Table 12) after  $V_{DD}$  has recovered. All logic inputs and outputs reference to DGND. For AC-disconnected detection, DGND and AGND must be connected together externally. Connect DGND to AGND at a single point in the system as close as possible to the MAX5965A/MAX5965B.

## Hardware Shutdown

$\overline{\text{SHD}}_-$  shuts down the respective ports without using the serial interface. Hardware shutdown offers an emergency turn-off feature that allows a fast disconnect of the power supply from the port. Pull  $\overline{\text{SHD}}_-$  low to remove power.  $\overline{\text{SHD}}_-$  also resets the corresponding events and status register bits.

## Interrupt

The MAX5965A/MAX5965B contain an open-drain logic output (INT) that goes low when an interrupt condition exists. R00h and R01h (Tables 6 and 7) contain the definitions of the interrupt registers. The mask register R01h determines events that trigger an interrupt. As a response to an interrupt, the controller reads the status of the event register to determine the cause of the interrupt and takes subsequent actions. Each interrupt event register also contains a Clear on Read (CoR) register. Reading through the CoR register address clears the interrupt. INT remains low when reading the interrupt through the read-only addresses. For example, to clear a startup fault on the port 4 read address 09h (see Table 11). Use the global pushbutton bit in register 1Ah (bit 7, Table 23) to clear interrupts, or use a software or hardware reset.

## Undervoltage and Overvoltage Protection

The MAX5965A/MAX5965B contain several undervoltage and overvoltage protection features. Table 12 in the *Register Map and Description* section shows a detailed list of the undervoltage and overvoltage protection features. An internal  $V_{EE}$  undervoltage lockout ( $V_{EEUVLO}$ ) circuit keeps the MOSFET off and the MAX5965A/MAX5965B in reset until  $V_{AGND} - V_{EE}$  exceeds 29V for more than 3ms. An internal  $V_{EE}$  overvoltage ( $V_{EE\_OV}$ ) circuit shuts down the ports when ( $V_{AGND} - V_{EE}$ ) exceeds

60V. The digital supply also contains an undervoltage lockout ( $V_{DDUVLO}$ ). The MAX5965A/MAX5965B also feature three other undervoltage and overvoltage interrupts:  $V_{EE}$  undervoltage interrupt ( $V_{EEUV}$ ),  $V_{DD}$  undervoltage interrupt ( $V_{DDUV}$ ), and  $V_{DD}$  overvoltage interrupt ( $V_{DDOV}$ ). A fault latches into the supply events register (Table 12), but the MAX5965A/MAX5965B does not shut down the ports with  $V_{EEUV}$ ,  $V_{DDUV}$ , or  $V_{DDOV}$ .

## DC Disconnect Monitoring

Setting R13h[DCD\_EN\_] bits high enables DC load monitoring during a normal powered state. If  $V_{RS}$  (the voltage across  $R_S$ ) falls below the DC load disconnect threshold,  $V_{DCTH}$ , for more than  $t_{DISC}$ , the device turns off power and asserts the LD\_DISC\_ bit of the corresponding port.

## AC Disconnect Monitoring (MAX5965A/MAX5965B)

The MAX5965A/MAX5965B feature AC load disconnect monitoring. Connect an external sine wave to OSC. The oscillator requirements are:

- 1)  $V_{P-P} \times \text{Frequency} = 200V_{P-P} \times \text{Hz} \pm 15\%$
- 2) Positive peak voltage > +2.2V
- 3) Frequency > 60Hz

A 100Hz  $\pm 10\%$ ,  $2V_{P-P} \pm 5\%$ , with +1.3V offset ( $V_{PEAK} = +2.3V$  typical) is recommended.

The MAX5965A/MAX5965B buffer and amplify three times the external oscillator signal and sends the signal to DET\_, where the sine wave is AC-coupled to the output. The MAX5965A/MAX5965B sense the presence of the load by monitoring the amplitude of the AC current returned to DET\_ (see the *Functional Diagram*).

Setting R13h[ACD\_EN\_] bits high enable AC load disconnect monitoring during a normal powered state. If the AC current peak at the DET\_ input falls below  $I_{ACTH}$  for more than  $t_{DISC}$ , the device turns off power and asserts the LD\_DISC\_ bit of the corresponding port.  $I_{ACTH}$  is programmable using R23h[2:0].

An internal comparator checks for a proper amplitude of the oscillator input. If the positive peak of the input sinusoid falls below a safety value of 2V (typ), OSC\_FAIL sets and the port shuts down. Power cannot be applied to the ports when ACD\_EN\_ is set high and OSC\_FAIL is set high. Leave OSC unconnected or connect it to DGND when not using AC-disconnect detection.

## Thermal Shutdown

If the MAX5965A/MAX5965B die temperature reaches +150°C, an overtemperature fault generates and the MAX5965A/MAX5965B shut down. The MOSFETs turn off. The die temperature of the MAX5965A/MAX5965B must cool down below +130°C to remove the overtemperature fault condition. After a thermal shutdown, the part is reset.

# High-Power, Quad, Monolithic, PSE Controllers for Power over Ethernet

## Watchdog

The R1Eh and R1Fh registers control the watchdog operation. The watchdog function, when enabled, allows the MAX5965A/MAX5965B to gracefully take over control or securely shuts down the power to the ports in case of software/firmware crashes. Contact the factory for more details.

## Address Inputs

A3, A2, A1, and A0 represent the 4 LSBs of the chip address. The complete chip address is 7 bits (see Table 4).

The 4 LSBs latch on the low-to-high transition of  $\overline{\text{RESET}}$  or after a power-supply start (either on  $V_{DD}$  or  $V_{EE}$ ). Address inputs default high through an internal 50k $\Omega$  pullup resistor to  $V_{DD}$ . The MAX5965A/MAX5965B also respond to the call through a global address 30h (see the *Global Addressing and Alert Response Protocol* section).

**Table 4. MAX5965A/MAX5965B Address**

0	1	0	A3	A2	A1	A0	R/W
---	---	---	----	----	----	----	-----

## I<sup>2</sup>C-Compatible Serial Interface

The MAX5965A/MAX5965B operate as a slave that sends and receives data through an I<sup>2</sup>C-compatible, 2-wire or 3-wire interface. The interface uses a serial-data input line (SDAIN), a serial-data output line (SDAOUT), and a serial-clock line (SCL) to achieve bidirectional communication between master(s) and slave(s). A master (typically a microcontroller) initiates all data transfers to and from the MAX5965A/MAX5965B, and generates the SCL clock that synchronizes the data transfer. In most applications, connect the SDAIN and the SDAOUT lines together to form the serial-data line (SDA).

Using the separate input and output data lines allows optocoupling with the controller bus when an isolated supply powers the microcontroller.

The MAX5965A/MAX5965B SDAIN line operates as an input. The MAX5965A/MAX5965B SDAOUT operates as an open-drain output. A pullup resistor, typically 4.7k $\Omega$ , is required on SDAOUT. The MAX5965A/MAX5965B SCL line operates only as an input. A pullup resistor, typically 4.7k $\Omega$ , is required on SCL if there are multiple masters, or if the master in a single-master system has an open-drain SCL output.

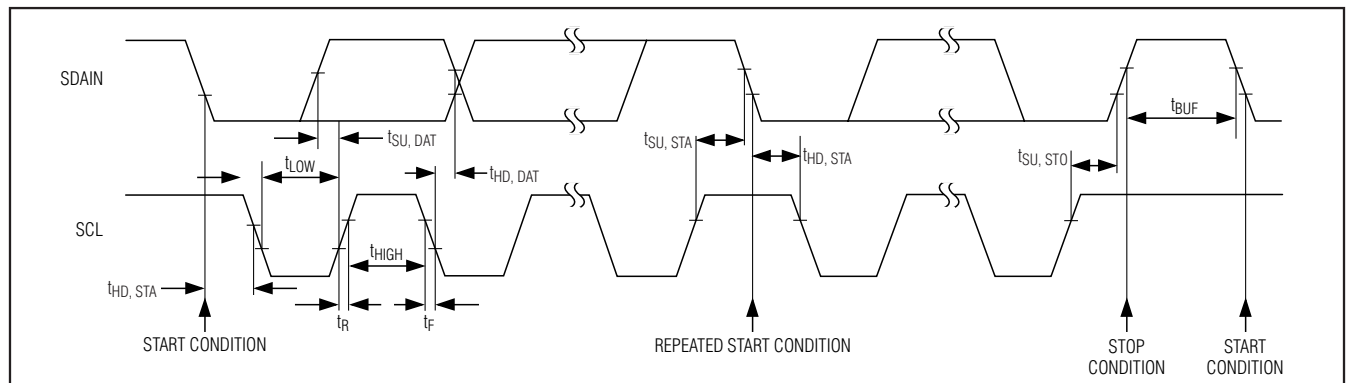

Figure 4. 2-Wire, Serial-Interface Timing Details

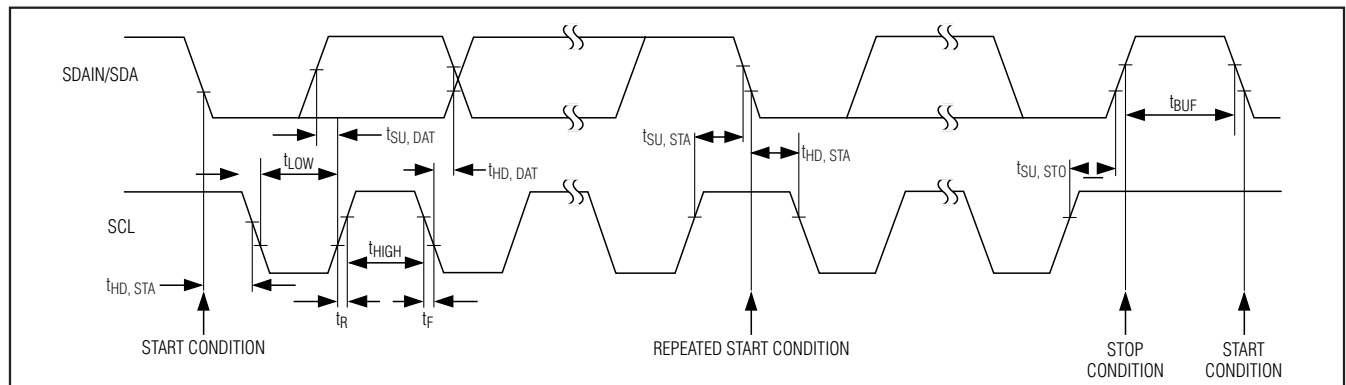

Figure 5. 3-Wire, Serial-Interface Timing Details

# High-Power, Quad, Monolithic, PSE Controllers for Power over Ethernet

## Serial Addressing

Each transmission consists of a START condition (Figure 6) sent by a master, followed by the MAX5965A/MAX5965B 7-bit slave address plus R/W bit, a register address byte, one or more data bytes, and finally a STOP condition.

## START and STOP Conditions

Both SCL and SDA remain high when the interface is not busy. A master signals the beginning of a transmission with a START (S) condition by transitioning SDA from high to low while SCL is high. When the master finishes communicating with the slave, the master issues a STOP (P) condition by transitioning SDA from low to high while SCL is high. The STOP condition frees the bus for another transmission.

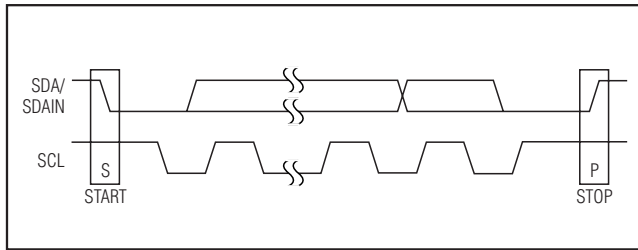

Figure 6. START and STOP Conditions

## Bit Transfer

Each clock pulse transfers one data bit (Figure 7). The data on SDA must remain stable while SCL is high.

## Acknowledge

The acknowledge bit is a clocked 9th bit (Figure 8) that the recipient uses to handshake receipt of each byte of data. Thus each byte effectively transferred requires 9 bits. The master generates the 9th clock pulse, and the recipient pulls down SDA (or the SDAOUT in the 3-wire interface) during the acknowledge clock pulse, so that the SDA line is stable low during the high period of the clock pulse. When the master transmits to the MAX5965A/MAX5965B, the MAX5965A/MAX5965B generate the acknowledge bit. When the MAX5965A/MAX5965B transmit to the master, the master generates the acknowledge bit.

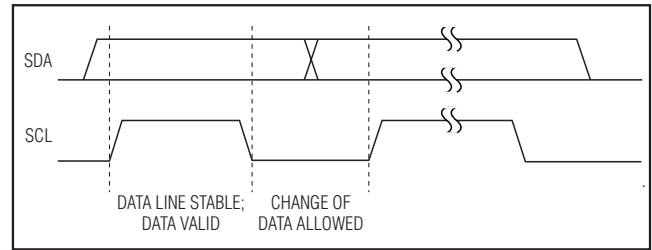

Figure 7. Bit Transfer

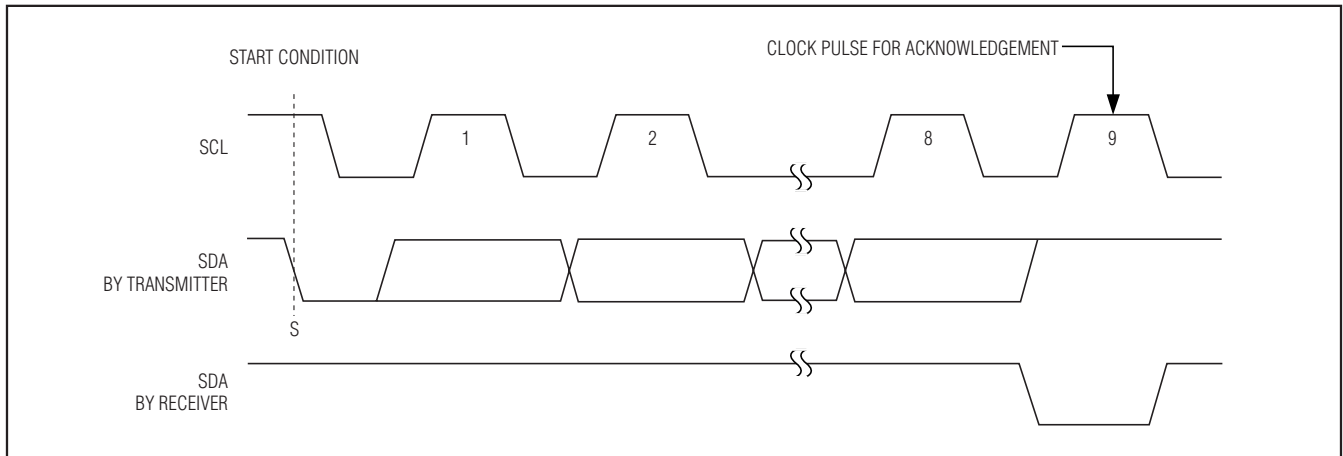

Figure 8. Acknowledge

# High-Power, Quad, Monolithic, PSE Controllers for Power over Ethernet

## Slave Address

The MAX5965A/MAX5965B have a 7-bit long slave address (Figure 9). The bit following the 7-bit slave address (bit eight) is the R/W bit, which is low for a write command and high for a read command.

010 always represents the first 3 bits (MSBs) of the MAX5965A/MAX5965B slave address. Slave address bits A3, A2, A1, and A0 represent the states of the MAX5965A/MAX5965B's A3, A2, A1, and A0 inputs, allowing up to sixteen MAX5965A/MAX5965B devices to share the bus. The states of the A3, A2, A1, and A0 latch in upon the reset of the MAX5965A/MAX5965B into register R11h. The MAX5965A/MAX5965B monitor the bus continuously, waiting for a START condition followed by the MAX5965A/MAX5965B's slave address. When a MAX5965A/MAX5965B recognizes its slave address, the MAX5965A/MAX5965B acknowledge and are then ready for continued communication.

## Global Addressing and Alert Response Protocol

The global address call is used in writing mode to write the same register to multiple devices (address 0x60). In read mode (address 0x61), the global address call is used as the alert response address. When responding to a global call, the MAX5965A/MAX5965B put their own address out on the data line whenever the interrupt is active. Every other device connected to the SDAOUT line that has an active interrupt also does this. After every bit transmitted, the MAX5965A/MAX5965B check that the data line effectively corresponds to the data it

is delivering. If it is not, it then backs off and frees the data line. This litigation protocol always allows the part with the lowest address to complete the transmission. The microcontroller can then respond to the interrupt and take proper actions. The MAX5965A/MAX5965B do not reset their own interrupt at the end of the alert response protocol. The microcontroller has to do it by clearing the event register through their CoR addresses or activating the CLR\_INT pushbutton.

## Message Format for Writing to the MAX5965A/MAX5965B

A write to the MAX5965A/MAX5965B comprises of the MAX5965A/MAX5965B's slave address transmission with the R/W bit set to 0, followed by at least 1 byte of information. The first byte of information is the command byte (Figure 10). The command byte determines which register of the MAX5965A/MAX5965B is written to by the next byte, if received. If the MAX5965A/MAX5965B detect a STOP condition after receiving the command byte, the MAX5965A/MAX5965B take no further action beyond storing the command byte. Any bytes received after the command byte are data bytes. The first data byte goes into the internal register of the MAX5965A/MAX5965B selected by the command byte. If the MAX5965A/MAX5965B transmit multiple data bytes before the MAX5965A/MAX5965B detect a STOP condition, these bytes store in subsequent MAX5965A/MAX5965B internal registers because the control byte address autoincrements.

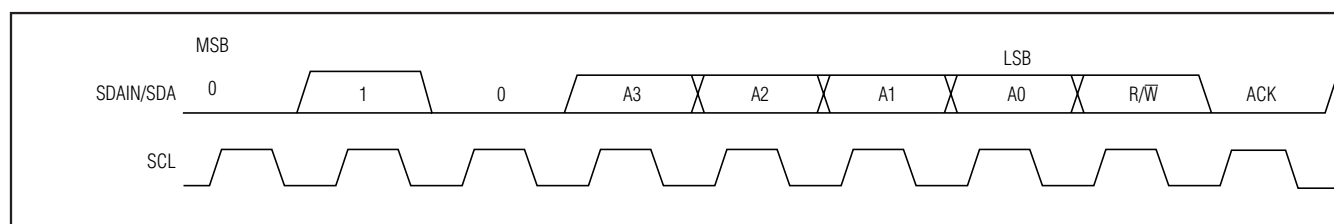

Figure 9. Slave Address

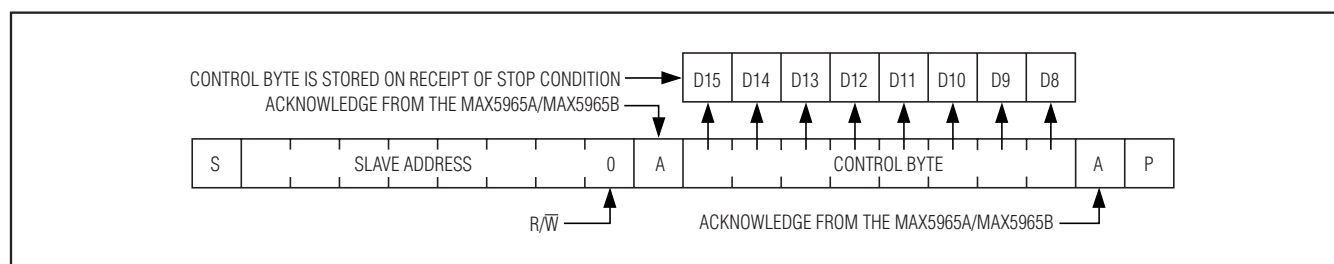

Figure 10. Control Byte Received

# High-Power, Quad, Monolithic, PSE Controllers for Power over Ethernet

## Message Format for Reading

The MAX5965A/MAX5965B read using the MAX5965A/MAX5965B's internally stored command byte as an address pointer, the same way the stored command byte is used as an address pointer for a write. The pointer autoincrements after reading each data byte using the same rules as for a write. Thus, a read is initiated by first configuring the MAX5965A/MAX5965B's command byte by performing a write. The master now reads 'n' consecutive bytes from the MAX5965A/MAX5965B, with the first data byte read from the register addressed by the initialized command byte. When performing read-after-write verification, remember to reset the command byte's address because the stored control byte address autoincrements after the write.

## Operation with Multiple Masters

When the MAX5965A/MAX5965B operate on a 2-wire interface with multiple masters, a master reading the MAX5965A/MAX5965B should use repeated starts between the write which sets the MAX5965A/MAX5965B's address pointer, and the read(s) that take the data from the location(s). It is possible for master 2 to take over the bus after master 1 has set up the

MAX5965A/MAX5965B's address pointer but before master 1 has read the data. If master 2 subsequently resets the MAX5965A/MAX5965B's address pointer then master 1's read may be from an unexpected location.

## Command Address Autoincrementing

Address autoincrementing allows the MAX5965A/MAX5965B to be configured with fewer transmissions by minimizing the number of times the command address needs to be sent. The command address stored in the MAX5965A/MAX5965B generally increments after each data byte is written or read (Table 5). The MAX5965A/MAX5965B are designed to prevent overwrites on unavailable register addresses and unintentional wrap-around of addresses.

**Table 5. Autoincrement Rules**

COMMAND BYTE ADDRESS RANGE	AUTOINCREMENT BEHAVIOR
0x00 to 0x26	Command address autoincrements after byte read or written
0x26	Command address remains at 0x26 after byte written or read

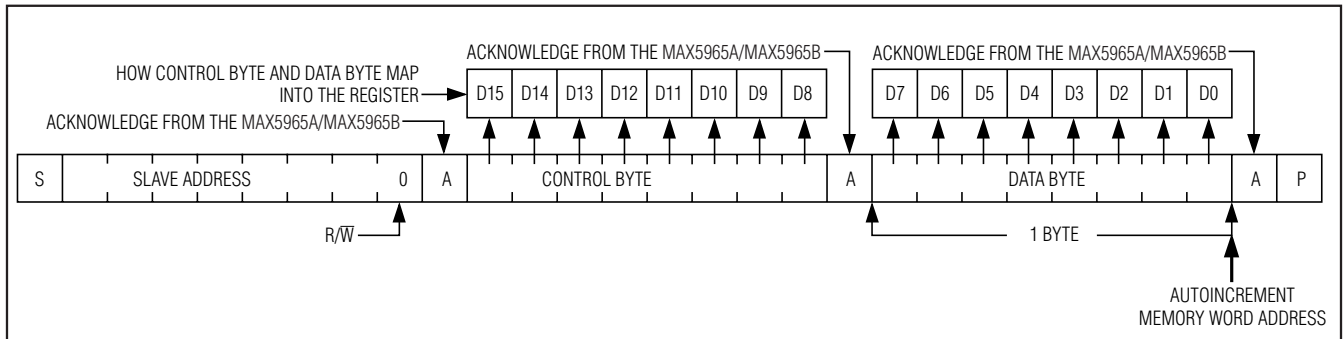

Figure 11. Control and Single Data Byte Received

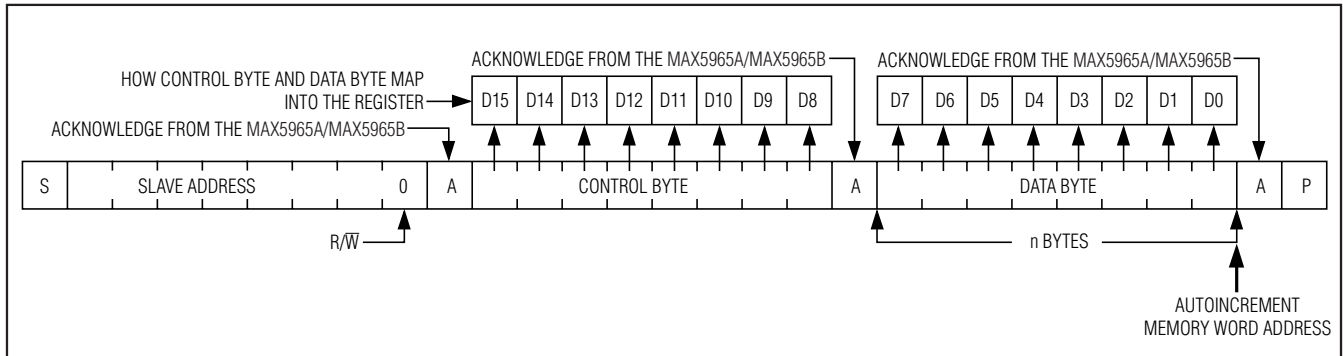

Figure 12. 'n' Data Bytes Received

# High-Power, Quad, Monolithic, PSE Controllers for Power over Ethernet

MAX5965A/MAX5965B

## Register Map and Description

The interrupt register (Table 6) summarizes the event register status and is used to send an interrupt signal (INT goes low) to the controller. Writing a 1 to R1Ah[7] clears all interrupt and events registers. A reset sets R00h to 00h.

INT\_EN (R17h[7]) is a global interrupt mask (Table 7). The MASK\_ bits activate the corresponding interrupt bits in register R00h. Writing a 0 to INT\_EN (R17h[7]) disables the INT output.

A reset sets R01h to AAA00A00b where A is the state of the AUTO input prior to the reset.

**Table 6. Interrupt Register**

ADDRESS = 00h			DESCRIPTION
SYMBOL	BIT	R/W	
SUP_FLT	7	R	Interrupt signal for supply faults. SUP_FLT is the logic OR of all the bits [7:0] in register R0Ah/R0Bh (Table 12).
TSTR_FLT	6	R	Interrupt signal for startup failures. TSTR_FLT is the logic OR of bits [7:0] in register R08h/R09h (Table 11).
IMAX_FLT	5	R	Interrupt signal for current-limit violations. IMAX_FLT is the logic OR of bits [3:0] in register R06h/R07h (Table 10).
CL_END	4	R	Interrupt signal for completion of classification. CL_END is the logic OR of bits [7:4] in register R04h/R05h (Table 9).
DET_END	3	R	Interrupt signal for completion of detection. DET_END is the logic OR of bits [3:0] in register R04h/R05h (Table 9).
LD_DISC	2	R	Interrupt signal for load disconnection. LD_DISC is the logic OR of bits [7:4] in register R06h/R07h (Table 10).
PG_INT	1	R	Interrupt signal for PGOOD status change. PG_INT is the logic OR of bits [7:4] in register R02h/R03h (Table 8).
PEN_INT	0	R	Interrupt signal for power-enable status change. PEN_INT is the logic OR of bits [3:0] in register R02h/R03h (Table 8).

**Table 7. Interrupt Mask Register**

ADDRESS = 01h			DESCRIPTION
SYMBOL	BIT	R/W	
MASK7	7	R/W	Interrupt mask bit 7. A logic-high enables the SUP_FLT interrupts. A logic-low disables the SUP_FLT interrupts.
MASK6	6	R/W	Interrupt mask bit 6. A logic-high enables the TSTR_FLT interrupts. A logic-low disables the TSTR_FLT interrupts.
MASK5	5	R/W	Interrupt mask bit 5. A logic-high enables the IMAX_FLT interrupts. A logic-low disables the IMAX_FLT interrupts.
MASK4	4	R/W	Interrupt mask bit 4. A logic-high enables the CL_END interrupts. A logic-low disables the CL_END interrupts.
MASK3	3	R/W	Interrupt mask bit 3. A logic-high enables the DET_END interrupts. A logic-low disables the DET_END interrupts.
MASK2	2	R/W	Interrupt mask bit 2. A logic-high enables the LD_DISC interrupts. A logic-low disables the LD_DISC interrupts.
MASK1	1	R/W	Interrupt mask bit 1. A logic-high enables the PG_INT interrupts. A logic-low disables the PG_INT interrupts.
MASK0	0	R/W	Interrupt mask bit 0. A logic-high enables the PEN_INT interrupts. A logic-low disables the PEN_INT interrupts.

# High-Power, Quad, Monolithic, PSE Controllers for Power over Ethernet

The power event register (Table 8) records changes in the power status of the four ports. Any change in PGOOD\_ (R10h[7:4]) sets PG\_CHG\_ to 1. Any change in the PWR\_EN\_ (R10h[3:0]) sets PWEN\_CHG\_ to 1. PG\_CHG\_ and PWEN\_CHG\_ trigger on the edges of PGOOD\_ and PWR\_EN\_ and do not depend on the

actual level of the bits. The power event register has two addresses. When read through the R02h address, the content of the register is left unchanged. When read through the CoR R03h address, the register content is cleared. A reset sets R02h/R03h = 00h.

**Table 8. Power Event Register**

SYMBOL	BIT	ADDRESS		DESCRIPTION
		02h	03h	
		R/W	R/W	
PG_CHG4	7	R	CoR	PGOOD change event for port 4
PG_CHG3	6	R	CoR	PGOOD change event for port 3
PG_CHG2	5	R	CoR	PGOOD change event for port 2
PG_CHG1	4	R	CoR	PGOOD change event for port 1
PWEN_CHG4	3	R	CoR	Power enable change event for port 4
PWEN_CHG3	2	R	CoR	Power enable change event for port 3
PWEN_CHG2	1	R	CoR	Power enable change event for port 2
PWEN_CHG1	0	R	CoR	Power enable change event for port 1

DET\_END\_/CL\_END\_ is set high whenever detection/classification is completed on the corresponding port. A 1 in any of the CL\_END\_ bits forces R00h[4] to 1. A 1 in any of the DET\_END\_ bits forces R00h[3] to 1. As with any of the other events register, the detect event register

has two addresses. When read through the R04h address, the content of the register is left unchanged. When read through the CoR R05h address, the register content is cleared. A reset sets R04h/R05h = 00h.

**Table 9. Detect Event Register**

SYMBOL	BIT	ADDRESS		DESCRIPTION
		04h	05h	
		R/W	R/W	
CL_END4	7	R	CoR	Classification completed on port 4
CL_END3	6	R	CoR	Classification completed on port 3
CL_END2	5	R	CoR	Classification completed on port 2
CL_END1	4	R	CoR	Classification completed on port 1
DET_END4	3	R	CoR	Detection completed on port 4
DET_END3	2	R	CoR	Detection completed on port 3
DET_END2	1	R	CoR	Detection completed on port 2
DET_END1	0	R	CoR	Detection completed on port 1

# High-Power, Quad, Monolithic, PSE Controllers for Power over Ethernet

LD\_DISC\_ is set high whenever the corresponding port shuts down due to detection of load removal. IMAX\_FLT\_ is set high when the port shuts down due to an extended overcurrent event after a successful start-up. A 1 in any of the LD\_DISC\_ bits forces R00h[2] to 1. A 1 in any of the IMAX\_FLT\_ bits forces R00h[5] to 1.

As with any of the other events register, the fault event register has two addresses. When read through the R06h address, the content of the register is left unchanged. When read through the CoR R07h address, the register content is cleared. A reset sets R06h/R07h = 00h.

**Table 10. Fault Event Register**

SYMBOL	BIT	ADDRESS		DESCRIPTION
		06h	07h	
		R/W	R/W	
LD_DISC4	7	R	CoR	Disconnect on port 4
LD_DISC3	6	R	CoR	Disconnect on port 3
LD_DISC2	5	R	CoR	Disconnect on port 2
LD_DISC1	4	R	CoR	Disconnect on port 1
IMAX_FLT4	3	R	CoR	Overcurrent on port 4
IMAX_FLT3	2	R	CoR	Overcurrent on port 3
IMAX_FLT2	1	R	CoR	Overcurrent on port 2
IMAX_FLT1	0	R	CoR	Overcurrent on port 1

If the port remains in current limit or the PGOOD condition is not met at the end of the startup period, the port shuts down and the corresponding STRT\_FLT\_ is set to 1. A 1 in any of the STRT\_FLT\_ bits forces R00h[6] to 1. IVC\_ is set to 1 whenever the port current exceeds the maximum allowed limit for the class (determined during the classification process). A 1 in any of IVC\_ forces R00h[6] to 1. When the CL\_DISC (R17h[2]) is set to 1,

the port also limits the load current according to its class as specified in the *Electrical Characteristics* table. As with any of the other events register, the startup event register has two addresses. When read through the R08h address, the content of the register is left unchanged. When read through the CoR R09h address, the register content is cleared. A reset sets R08h/R09h = 00h.

**Table 11. Startup Event Register**

SYMBOL	BIT	ADDRESS		DESCRIPTION
		08h	09h	
		R/W	R/W	
IVC4	7	R	CoR	Class overcurrent flag for port 4
IVC3	6	R	CoR	Class overcurrent flag for port 3
IVC2	5	R	CoR	Class overcurrent flag for port 2
IVC1	4	R	CoR	Class overcurrent flag for port 1
STRT_FLT4	3	R	CoR	Startup failed on port 4
STRT_FLT3	2	R	CoR	Startup failed on port 3
STRT_FLT2	1	R	CoR	Startup failed on port 2
STRT_FLT1	0	R	CoR	Startup failed on port 1

## High-Power, Quad, Monolithic, PSE Controllers for Power over Ethernet

The MAX5965A/MAX5965B continuously monitor the power supplies and set the appropriate bits in the supply event register (Table 12).  $V_{DD\_OV}/V_{EE\_OV}$  is set to 1 whenever  $V_{DD}/V_{EE}$  exceeds its overvoltage threshold.  $V_{DD\_UV}/V_{EE\_UV}$  is set to 1 whenever  $V_{DD}/V_{EE}$  falls below its undervoltage threshold.

OSC\_FAIL is set to 1 whenever the amplitude of the oscillator signal at the OSC input falls below a level that might compromise the AC disconnect detection function. OSC\_FAIL generates an interrupt only if at least one of the ACD\_EN (R13h[7:4]) bits is set high.

A thermal shutdown circuit monitors the temperature of the die and resets the MAX5965A/MAX5965B if the temperature exceeds +150°C. TSD is set to 1 after the MAX5965A/MAX5965B return to normal operation. TSD is also set to 1 after every UVLO reset.

When  $V_{DD}$  and/or  $V_{EE}$  is below its UVLO threshold, the MAX5965A/MAX5965B are in reset mode and securely holds all ports off. When  $V_{DD}$  and  $V_{EE}$  rise to above their respective UVLO thresholds, the device comes out of reset as soon as the last supply crosses the UVLO threshold. The last supply corresponding UV and UVLO bits in the supply event register is set to 1.

A 1 in any supply event register's bits forces R00h[7] to 1. As with any of the other events register, the supply event register has two addresses. When read through the R0Ah address, the content of the register is left unchanged. When read through the CoR R0Bh address, the register content is cleared. A reset sets R0Ah/R0Bh to 00100001b if  $V_{DD}$  comes up after  $V_{EE}$  or to 00010100b if  $V_{EE}$  comes up after  $V_{DD}$ .

**Table 12. Supply Event Register**

SYMBOL	BIT	ADDRESS		DESCRIPTION
		0Ah	0Bh	
		R/W	R/W	
TSD	7	R	CoR	Overtemperature shutdown
$V_{DD\_OV}$	6	R	CoR	$V_{DD}$ overvoltage condition
$V_{DD\_UV}$	5	R	CoR	$V_{DD}$ undervoltage condition
$V_{EE\_UVLO}$	4	R	CoR	$V_{EE}$ undervoltage lockout condition
$V_{EE\_OV}$	3	R	CoR	$V_{EE}$ overvoltage condition
$V_{EE\_UV}$	2	R	CoR	$V_{EE}$ undervoltage condition
OSC_FAIL	1	R	CoR	Oscillator amplitude is below limit
$V_{DD\_UVLO}$	0	R	CoR	$V_{DD}$ undervoltage lockout condition

# High-Power, Quad, Monolithic, PSE Controllers for Power over Ethernet

The port status register (Table 13a) records the results of the detection and classification at the end of each phase in three encoding bits each. R0Ch contains the detection and classification status of port 1. R0Dh corresponds to port 2, R0Eh corresponds to port 3, and R0Fh corresponds to port 4. Tables 13b and 13c show the detection/classification result decoding charts, respectively. For CLC\_EN = 0, the detection result is shown in Table 13b. When CLC\_EN is set high, the MAX5965A/MAX5965B allow valid detection of high capacitive load of up to 150μF.

When 2-event classification is not enabled (ENx\_CL6 = 0), the classification status is reported in Table 13c. When 2-event classification is enabled (ENx\_CL6 = 1), the CLASS\_[2:0] bits are set to 000 and the classification result is reported in locations R2Ch–R2Fh.

As a protection, when POFF\_CL (R17h[3], Table 21) is set to 1, the MAX5965A/MAX5965B prohibit turning on power to the port that returns a status 111 after classification. A reset sets 0Ch, 0Dh, 0Eh, and 0Fh = 00h.

**Table 13a. Port Status Registers**

ADDRESS = 0Ch, 0Dh, 0Eh, 0Fh			DESCRIPTION
SYMBOL	BIT	R/W	
Reserved	7	R	Reserved
CLASS_	6	R	CLASS_[2]
	5	R	CLASS_[1]
	4	R	CLASS_[0]
Reserved	3	R	Reserved
DET_ST_	2	R	DET_ST_[2]
	1	R	DET_ST_[1]
	0	R	DET_ST_[0]

**Table 13b. Detection Result Decoding Chart**

DET_ST_[2:0] (ADDRESS = 0Ch, 0Dh, 0Eh, 0Fh)	DETECTED	DESCRIPTION
000	None	Detection status unknown
001	DCP	Positive DC supply connected at the port (AGND - V <sub>OUT_</sub> < 1V)
010	HIGH CAP	High capacitance at the port (> 8.5μF)
011	RLOW	Low resistance at the port, R <sub>PD</sub> < 15kΩ
100	DET_OK	Detection pass, 15kΩ < R <sub>PD</sub> < 33kΩ
101	RHIGH	High resistance at the port, R <sub>PD</sub> > 33kΩ
110	OPEN0	Open port (I < 10μA)
111	DCN	Negative DC supply connected to the port (V <sub>OUT_</sub> - V <sub>EE</sub> < 2V)

**Table 13c. Classification Result Decoding Chart**

CLASS_[2:0] (ADDRESS = 0Ch, 0Dh, 0Eh, 0Fh)	CLASS RESULT
000	Unknown
001	1
010	2
011	3
100	4
101	5
110	0
111	Current limit (> I <sub>CILIM</sub> )

## High-Power, Quad, Monolithic, PSE Controllers for Power over Ethernet

PGOOD\_ is set to 1 (Table 14) at the end of the power-up startup period if the power-good condition is met ( $0 < (V_{OUT\_} - V_{EE}) < PG_{TH}$ ). The power-good condition must remain valid for more than  $t_{PGOOD}$  to assert PGOOD\_. PGOOD\_ is reset to 0 whenever the output falls out of the power-good condition. A fault condition immediately forces PGOOD\_ low.

PWR\_EN\_ is set to 1 when the port power is turned on. PWR\_EN\_ resets to 0 as soon as the port turns off. Any transition of PGOOD\_ and PWR\_EN\_ bits set the corresponding bit in the power event registers R02h/R03h (Table 8). A reset sets R10h = 00h.

**Table 14. Power Status Register**

ADDRESS = 10h			DESCRIPTION
SYMBOL	BIT	R/W	
PGOOD4	7	R	Power-good condition on port 4
PGOOD3	6	R	Power-good condition on port 3
PGOOD2	5	R	Power-good condition on port 2
PGOOD1	4	R	Power-good condition on port 1
PWR_EN4	3	R	Power is enabled on port 4
PWR_EN3	2	R	Power is enabled on port 3
PWR_EN2	1	R	Power is enabled on port 2
PWR_EN1	0	R	Power is enabled on port 1

A3, A2, A1, A0 (Table 15) represent the 4 LSBs of the MAX5965A/MAX5965B address (Table 4). During a reset, the device latches into R11h. These 4 bits

address from the corresponding inputs as well as the state of the MIDSPAN and AUTO inputs. Changes to those inputs during normal operation are ignored.

**Table 15. Address Input Status Register**

ADDRESS = 11h			DESCRIPTION
SYMBOL	BIT	R/W	
Reserved	7	R	Reserved
Reserved	6	R	Reserved
A3	5	R	Device address, A3 pin latched-in status
A2	4	R	Device address, A2 pin latched-in status
A1	3	R	Device address, A1 pin latched-in status
A0	2	R	Device address, A0 pin latched-in status
MIDSPAN	1	R	MIDSPAN input's latched-in status
AUTO	0	R	AUTO input's latched-in status

# High-Power, Quad, Monolithic, PSE Controllers for Power over Ethernet

The MAX5965A/MAX5965B use 2 bits for each port to set the mode of operation. Set the modes according to Table 16a and 16b.

A reset sets R12h = AAAAAAAAb where A represents the latched-in state of the AUTO input prior to the reset. Use software to change the mode of operation. Software resets of ports (RESET\_P\_ bit, Table 23) do not affect the mode register.

**Table 16a. Operating Mode Register**

ADDRESS = 12h			DESCRIPTION
SYMBOL	BIT	R/W	
P4_M1	7	R/W	MODE[1] for port 4
P4_M0	6	R/W	MODE[0] for port 4
P3_M1	5	R/W	MODE[1] for port 3
P3_M0	4	R/W	MODE[0] for port 3
P2_M1	3	R/W	MODE[1] for port 2
P2_M0	2	R/W	MODE[0] for port 2
P1_M1	1	R/W	MODE[1] for port 1
P1_M0	0	R/W	MODE[0] for port 1

**Table 16b. Operating Mode Status**

MODE	DESCRIPTION
00	Shutdown
01	Manual
10	Semi-auto
11	Auto

Setting DCD\_EN\_ to 1 enables the DC load disconnect detection feature (Table 17). Setting ACD\_EN\_ to 1 enables the AC load disconnect feature. If enabled, the load disconnect detection starts during power mode

and after startup when the corresponding PGOOD\_ bit in register R10h (Table 14) goes high. A reset sets R13h = 0000AAAAb where A represents the latched-in state of the AUTO input prior to the reset.

**Table 17. Load Disconnect Detection Enable Register**

ADDRESS = 13h			DESCRIPTION
SYMBOL	BIT	R/W	
ACD_EN4	7	R/W	Enable AC disconnect detection on port 4
ACD_EN3	6	R/W	Enable AC disconnect detection on port 3
ACD_EN2	5	R/W	Enable AC disconnect detection on port 2
ACD_EN1	4	R/W	Enable AC disconnect detection on port 1
DCD_EN4	3	R/W	Enable DC disconnect detection on port 4
DCD_EN3	2	R/W	Enable DC disconnect detection on port 3
DCD_EN2	1	R/W	Enable DC disconnect detection on port 2
DCD_EN1	0	R/W	Enable DC disconnect detection on port 1

# High-Power, Quad, Monolithic, PSE Controllers for Power over Ethernet

Setting DET\_EN\_/CLASS\_EN\_ to 1 (Table 18) enables load detection/classification, respectively. Detection always has priority over classification. To perform classification without detection, set the DET\_EN\_ bit low and CLASS\_EN\_ bit high.

In manual mode, R14h works like a pushbutton. Set the bits high to begin the corresponding routine. The bit clears after the routine finishes.

When entering auto mode, R14h defaults to FFh. When entering semi or manual modes, R14h defaults to 00h. A reset or power-up sets R14h = AAAAAAAb where A represents the latched-in state of the AUTO input prior to the reset.

**Table 18. Detection and Classification Enable Register**

ADDRESS = 14h			DESCRIPTION
SYMBOL	BIT	R/W	
CLASS_EN4	7	R/W	Enable classification on port 4
CLASS_EN3	6	R/W	Enable classification on port 3
CLASS_EN2	5	R/W	Enable classification on port 2
CLASS_EN1	4	R/W	Enable classification on port 1
DET_EN4	3	R/W	Enable detection on port 4
DET_EN3	2	R/W	Enable detection on port 3
DET_EN2	1	R/W	Enable detection on port 2
DET_EN1	0	R/W	Enable detection on port 1

EN\_HP\_CL\_, EN\_HP\_ALL together with CL\_DISC (R17h[2]) and ENx\_CL6 (R1Ch[7:4]) are used to program the high-power mode. See Table 3 for details.

Setting BCKOFF\_ to 1 (Table 19) enables cadence timing on each port where the port backs off and waits 2.2s after each failed load discovery detection. The

IEEE 802.3af standard requires a PSE that delivers power through the spare pairs (midspan PSE) to have cadence timing.

A reset or power-up sets R15h = 0000XXXXb where 'X' is the logic AND of the MIDSPAN and AUTO inputs.

**Table 19. Backoff and High-Power Enable Register**

ADDRESS = 15h			DESCRIPTION
SYMBOL	BIT	R/W	
EN_HP_ALL	7	R/W	High-power detection enabled
EN_HP_CL6	6	R/W	Class 6 PD high-power enabled
EN_HP_CL5	5	R/W	Class 5 PD high-power enabled
EN_HP_CL4	4	R/W	Class 4 PD high-power enabled
BCKOFF4	3	R/W	Enable cadence timing on port 4
BCKOFF3	2	R/W	Enable cadence timing on port 3
BCKOFF2	1	R/W	Enable cadence timing on port 2
BCKOFF1	0	R/W	Enable cadence timing on port 1

# High-Power, Quad, Monolithic, PSE Controllers for Power over Ethernet

MAX5965A/MAX5965B

TSTART[1,0] (Table 20a) programs the startup timers. Startup time is the time the port is allowed to be in current limit during startup. TFAULT[1,0] programs the fault time. Fault time is the time allowed for the port to be in current limit during normal operation. RSTR[1,0] programs the discharge rate of the TFAULT\_ counter and effectively sets the time the port remains off after an overcurrent fault. TDISC[1,0] programs the load disconnect detection time. The device turns off power to the port if it fails to provide a minimum power maintenance signal for longer than the load disconnect detection time (t<sub>DISC</sub>).

Set the bits in R16h to scale the t<sub>START</sub>, t<sub>FAULT</sub>, and t<sub>DISC</sub> to a multiple of their nominal value specified in the *Electrical Characteristics* table.

When the MAX5965A/MAX5965B shut down a port due to an extended overcurrent condition (either during startup or normal operation), if RSTR\_EN is set high, the part does not allow the port to power back on before the restart timer (Table 20b) returns to zero. This effectively sets a minimum duty cycle that protects the external MOSFET from overheating during prolonged output overcurrent conditions. A reset sets R16h = 00h.

**Table 20a. Timing Configuration Register**

ADDRESS = 16h			DESCRIPTION
SYMBOL	BIT	R/W	
RSTR[1]	7	R/W	Restart timer programming bit 1
RSTR[0]	6	R/W	Restart timer programming bit 0
TSTART[1]	5	R/W	Startup timer programming bit 1
TSTART[0]	4	R/W	Startup timer programming bit 0
TFAULT[1]	3	R/W	Overcurrent timer programming bit 1
TFAULT[0]	2	R/W	Overcurrent timer programming bit 0
TDISC[1]	1	R/W	Load disconnect timer programming bit 1
TDISC[0]	0	R/W	Load disconnect timer programming bit 0

**Table 20b. Startup, Fault, and Load Disconnect Timer Values for Timing Register**

BIT [1:0] (ADDRESS = 16h)	RSTR	t <sub>DISC</sub>	t <sub>START</sub>	t <sub>FAULT</sub>
00	16 x t <sub>FAULT</sub>	t <sub>DISC</sub> nominal (350ms, typ)	t <sub>START</sub> nominal (60ms, typ)	t <sub>FAULT</sub> nominal (60ms, typ)
01	32 x t <sub>FAULT</sub>	1/4 x t <sub>DISC</sub> nominal	1/2 x t <sub>START</sub> nominal	1/2 x t <sub>FAULT</sub> nominal
10	64 x t <sub>FAULT</sub>	1/2 x t <sub>DISC</sub> nominal	2 x t <sub>START</sub> nominal	2 x t <sub>FAULT</sub> nominal
11	0 x t <sub>FAULT</sub>	2 x t <sub>DISC</sub> nominal	4 x t <sub>START</sub> nominal	4 x t <sub>FAULT</sub> nominal

# High-Power, Quad, Monolithic, PSE Controllers for Power over Ethernet

Setting CL\_DISC to 1 (Table 21) enables port over class current protection, where the MAX5965A/MAX5965B scales down the overcurrent limit (VFLT\_LIM) according to the port classification status. This feature provides protection to the system against PDs that violate their maximum class current allowance.

The MAX5965 is programmed to switch to a high-power configuration and HP\_TIME is low, the higher current setting is enabled only after a successful startup so that the PD powers up as a normal 15W device. If HP\_TIME is set together with EN\_HP\_ALL, the higher current setting will

be active before startup. For Classes 4, 5, and 6, the corresponding enable bit in register R15h must be set together with EN\_HP\_ALL. In any other cases, the current level defaults to Class 0.

CL\_DISC, together with EN\_HP\_CL\_ (R15h[6:4]), EN\_HP\_ALL (R15h[7]), and ENx\_CL6 (R1Ch[7:4]) are used to program the high-power mode. See Table 3 for details.

Setting OUT\_ISO high (Table 21), forces DET\_ to a high-impedance state.

A reset sets R17h = 0xC0.

**Table 21. Miscellaneous Configurations 1 Register**

ADDRESS = 17h			DESCRIPTION
SYMBOL	BIT	R/W	
INT_EN	7	R/W	A logic-high enables INT functionality
RSTR_EN	6	R/W	A logic-high enables the autorestart protection time off (as set by the RSTR[1:0] bits)
Reserved	5	—	Reserved
Reserved	4	—	Reserved
POFF_CL	3	R	A logic-high prevents power-up after a classification failure (I > 50mA, valid only in AUTO mode)
CL_DISC	2	R/W	A logic-high enables reduced current-limit voltage threshold (VFLT_LIM) according to port classification result
OUT_ISO	1	R/W	Forces DET_ to high impedance. Does not interfere with other circuit operation.
HP_TIME	0	R/W	Enables high power after startup.

Power-enable pushbutton for semi and manual modes is found in Table 22. Setting PWR\_ON\_ to 1 turns on power to the corresponding port. Setting PWR\_OFF\_ to 1 turns off power to the port. PWR\_ON\_ is ignored when the port is already powered and during shutdown. PWR\_OFF\_ is ignored when the port is already off and

during shutdown. After execution, the bits reset to 0. During detection or classification, if PWR\_ON\_ goes high, the MAX5965A/MAX5965B gracefully terminate the current operation and turn on power to the port. The MAX5965A/MAX5965B ignore the PWR\_ON\_ in auto mode. A reset sets R19h = 00h.

**Table 22. Power-Enable Pushbuttons Register**

ADDRESS = 19h			DESCRIPTION
SYMBOL	BIT	R/W	
PWR_OFF4	7	W	A logic-high powers off port 4
PWR_OFF3	6	W	A logic-high powers off port 3
PWR_OFF2	5	W	A logic-high powers off port 2
PWR_OFF1	4	W	A logic-high powers off port 1
PWR_ON4	3	W	A logic-high powers on port 4
PWR_ON3	2	W	A logic-high powers on port 3
PWR_ON2	1	W	A logic-high powers on port 2
PWR_ON1	0	W	A logic-high powers on port 1

# High-Power, Quad, Monolithic, PSE Controllers for Power over Ethernet

Writing a 1 to CLR\_INT (Table 23) clears all the event registers and the corresponding interrupt bits in register R00h. Writing a 1 to RESET\_P\_ turns off power to the corresponding port and resets only the status and

event registers of that port. After execution, the bits reset to 0. Writing a 1 to RESET\_IC causes a global software reset, after which the register map is set back to its reset state. A reset sets R1Ah = 00h.

**Table 23. Global Pushbuttons Register**

ADDRESS = 1Ah			DESCRIPTION
SYMBOL	BIT	R/W	
CLR_INT	7	W	A logic-high clears all interrupts
Reserved	6	—	Reserved
Reserved	5	—	Reserved
RESET_IC	4	W	A logic-high resets the MAX5965A/MAX5965B
RESET_P4	3	W	A logic-high resets port 4
RESET_P3	2	W	A logic-high resets port 3
RESET_P2	1	W	A logic-high resets port 2
RESET_P1	0	W	A logic-high resets port 1

The ID register (Table 24) keeps track of the device ID number and revision. The MAX5965A/MAX5965B's

ID\_CODE[4:0] = 11001b. Contact the factory for REV[2:0] value.

**Table 24. ID Register**

ADDRESS = 1Bh			DESCRIPTION
SYMBOL	BIT	R/W	
ID_CODE	7	R	ID_CODE[4]
	6	R	ID_CODE[3]
	5	R	ID_CODE[2]
	4	R	ID_CODE[1]
	3	R	ID_CODE[0]
REV	2	R	REV[2]
	1	R	REV[1]
	0	R	REV[0]

# High-Power, Quad, Monolithic, PSE Controllers for Power over Ethernet

Enable 2-event classification for a port by setting the corresponding ENx\_CL6 bit (Table 25). When the bit is enabled, the classification cycle will be repeated three times at 21.3ms intervals. The device keeps the output voltage around -9V between each cycle. The repetition of the classification cycles enables discovering of class 6 PDs. The ENx\_CL6 bit is active only in auto- or semi-mode.

**Note:** Performing three consecutive classifications in manual mode is not the same as performing 2-event classification in semi or auto mode.

Enable the SMODE function (Table 25) by setting EN\_WHDOG (R1Fh[7]) to 1. The SMODE\_ bit goes high when the watchdog counter reaches zero and the port(s) switch over to hardware-controlled mode. SMODE\_ also goes high each and every time the software tries to power on a port, but is denied since the port is in hardware mode. A reset sets R1Ch = 00h.

**Table 25. SMODE and 2-Event Enable Register**

ADDRESS = 1Ch			DESCRIPTION
SYMBOL	BIT	CoR or R/W	
EN4_CL6	7	R/W	Port 4 2-event classification enabled
EN3_CL6	6	R/W	Port 3 2-event classification enabled
EN2_CL6	5	R/W	Port 2 2-event classification enabled
EN1_CL6	4	R/W	Port 1 2-event classification enabled
SMODE4	3	CoR	Port 4 hardware control flag
SMODE3	2	CoR	Port 3 hardware control flag
SMODE2	1	CoR	Port 2 hardware control flag
SMODE1	0	CoR	Port 1 hardware control flag

Set EN\_WHDOG (R1Fh[7]) to 1 to enable the watchdog function. When activated, the watchdog timer counter, WDTIME[7:0], continuously decrements toward zero once every 164ms. Once the counter reaches zero (also called watchdog expiry), the MAX5965A/MAX5965B enter hardware-controlled mode and each port shifts to a mode set by the HWMODE\_ bit in register R1Fh (Table 27). Use software to set WDTIME (Table 26) and continuously set this register to some nonzero value before the register reaches zero to prevent a watchdog expiry.

In this way, the software gracefully manages the power to ports upon a system crash or switchover.

While in hardware-controlled mode, the MAX5965A/MAX5965B ignore all requests to turn the power on and the flag SMODE\_ indicates that the hardware has taken control of the MAX5965A/MAX5965B operation. In addition, the software is not allowed to change the mode of operation in hardware-controlled mode. A reset sets R1Eh = 00h.

**Table 26. Watchdog Register**

ADDRESS = 1Eh			DESCRIPTION
SYMBOL	BIT	R/W	
WDTIME	7	R/W	WDTIME[7]
	6	R/W	WDTIME[6]
	5	R/W	WDTIME[5]
	4	R/W	WDTIME[4]
	3	R/W	WDTIME[3]
	2	R/W	WDTIME[2]
	1	R/W	WDTIME[1]
	0	R/W	WDTIME[0]

# High-Power, Quad, Monolithic, PSE Controllers for Power over Ethernet

Setting EN\_WHDOG (Table 27) high activates the watchdog counter. When the counter reaches zero, the port switches to the hardware-controlled mode determined by the corresponding HWMODE\_ bit. A low in HWMODE\_ switches the port into shutdown by setting

the bits in register R12h to 00. A high in HWMODE\_ switches the port into auto mode by setting the bits in register R12h to 11. If WD\_INT\_EN is set, an interrupt is sent if any of the SMODE bits are set. A reset sets R1Fh = 00h.

**Table 27. Switch Mode Register**

ADDRESS = 1Fh			DESCRIPTION
SYMBOL	BIT	R/W	
EN_WHDOG	7	R/W	A logic-high enables the watchdog function
WD_INT_EN	6	R/W	Enables interrupt on SMODE_ bits
Reserved	5	—	Reserved
Reserved	4	—	Reserved
HWMODE4	3	R/W	Port 4 switches to AUTO if logic-high and to SHUTDOWN if logic-low when watchdog timer expires
HWMODE3	2	R/W	Port 3 switches to AUTO if logic-high and to SHUTDOWN if logic-low when watchdog timer expires
HWMODE2	1	R/W	Port 2 switches to AUTO if logic-high and to SHUTDOWN if logic-low when watchdog timer expires
HWMODE1	0	R/W	Port 1 switches to AUTO if logic-high and to SHUTDOWN if logic-low when watchdog timer expires

The CLC\_EN enables the large capacitor detection feature. When CLC\_EN is set the device can recognize a capacitor load up to 150μF. If the CLC\_EN is reset, the MAX5965A/MAX5965B perform normal detection.

AC\_TH allows programming of the threshold of the AC disconnect comparator. The threshold is defined as a current since the comparators verify that the peak of the current pulses sensed at the DET\_ input exceed a preset threshold. The current threshold is defined as follows:

$$IAC\_TH = 226.68\mu A + 28.33 \times NAC\_TH$$

where NAC\_TH is the decimal value of AC\_TH.

When set low, DET\_BY inhibits port power-on if the discovery detection was bypassed in auto mode. When set high, DET\_BY allows the device to turn on power to a non-IEEE 802.3af load without doing detection. If OSCF\_RS is set high, the OSC\_FAIL bit is ignored. A reset or power-up sets R23h = 04h. Default IAC\_TH is 340μA.

**Table 28. Program Register**

ADDRESS = 23h			DESCRIPTION
SYMBOL	BIT	R/W	
Reserved	7	—	Reserved
Reserved	6	—	Reserved
CLC_EN	5	R/W	Large capacitor detection enable
DET_BY	4	R/W	Enables skipping detection in AUTO mode
OSCF_RS	3	R/W	OSC_FAIL reset bit
AC_TH	2	R/W	AC_TH[2]
	1	R/W	AC_TH[1]
	0	R/W	AC_TH[0]

# High-Power, Quad, Monolithic, PSE Controllers for Power over Ethernet

HP[2:0] programs the default power setting that is written upon the discovery of a class 4, 5, or 6 PD. A reset or power-up sets R24h = 00h.

**Table 29. High-Power Mode Register**

ADDRESS = 24h			DESCRIPTION
SYMBOL	BIT	R/W	
Reserved	7	—	Reserved
HP	6	R/W	HP[2]
	5	R/W	HP[1]
	4	R/W	HP[0]
Reserved	3	—	Reserved
	2	—	Reserved
	1	—	Reserved
	0	—	Reserved

**Table 30. Reserved Register (25h)**

ADDRESS = 25h			DESCRIPTION
SYMBOL	BIT	R/W	
Reserved	7	—	Reserved
	6	—	Reserved
	5	—	Reserved
	4	—	Reserved
	3	—	Reserved
	2	—	Reserved
	1	—	Reserved
	0	—	Reserved

**Table 31. Reserved Register (26h)**

ADDRESS = 26h			DESCRIPTION
SYMBOL	BIT	R/W	
Reserved	7	—	Reserved
	6	—	Reserved
	5	—	Reserved
	4	—	Reserved
	3	—	Reserved
	2	—	Reserved
	1	—	Reserved
	0	—	Reserved

# High-Power, Quad, Monolithic, PSE Controllers for Power over Ethernet

The IVEE bits enable the current-limit scaling (Table 32). This feature is used to reduce the current limit for systems running at higher voltage to maintain the

desired output power. Table 33 sets the current-limit scaling register. A reset or power-up sets R29h = 00h.

**Table 32. Miscellaneous Configurations 2**

ADDRESS = 29h			DESCRIPTION
SYMBOL	BIT	R/W	
Reserved	7	—	Reserved
	6	—	Reserved
	5	—	Reserved
	4	—	Reserved
	3	—	Reserved
LSC_EN	2	—	LSC_EN
IVEE	1	R/W	IVEE[1]
	0	R/W	IVEE[0]

The three ICUT\_ bits (Tables 34a and 34b) allow programming of the current-limit and overcurrent thresholds in excess of the IEEE 802.3af standard limit. The MAX5965A/MAX5965B can automatically set the ICUT register or can be manually written to by the software (see Table 3).

**Table 33. Current-Limit Scaling Register**

IVEE[1:0] (ADDRESS = 29h)	CURRENT LIMIT (%)
00	Default
01	-5
10	-10
11	-15

Class 1 and 2 limits can also be programmed by software independently from the classification status. See Table 3. A reset or power-up sets R2Ah = R2Bh = 00h.

**Table 34a. ICUT Registers 1 and 2**

ADDRESS = 2Ah			DESCRIPTION
SYMBOL	BIT	R/W	
Reserved	7	—	Reserved
ICUT2	6	R/W	ICUT2[2]
	5	R/W	ICUT2[1]
	4	R/W	ICUT2[0]
Reserved	3	—	Reserved
ICUT1	2	R/W	ICUT1[2]
	1	R/W	ICUT1[1]
	0	R/W	ICUT1[0]

**Table 34b. ICUT Registers 3 and 4**

ADDRESS = 2Bh			DESCRIPTION
SYMBOL	BIT	R/W	
Reserved	7	—	Reserved
ICUT4	6	R/W	ICUT4[2]
	5	R/W	ICUT4[1]
	4	R/W	ICUT4[0]
Reserved	3	—	Reserved
ICUT3	2	R/W	ICUT3[2]
	1	R/W	ICUT3[1]
	0	R/W	ICUT3[0]

# High-Power, Quad, Monolithic, PSE Controllers for Power over Ethernet

Table 34c. ICUT Register Bit Values for Current-Limit Threshold

ICUT_[2:0] (ADDRESS = 2Ah, 2Bh)	SCALE FACTOR	TYPICAL CURRENT-LIMIT THRESHOLD (mA)
000	1x	375
001	1.5x	563
010	1.75x	656
011	2x	750
100	2.25x	844
101	2.5x	938
110	0.3x	Class 1
111	0.53x	Class 2

Table 35a. Classification Status Registers

ADDRESS = 2Ch, 2Dh, 2Eh, 2Fh			DESCRIPTION
SYMBOL	BIT	R/W	
Reserved	7	—	Reserved
	6	—	Reserved

Table 35b. Class Sequence States

CLASS_[5:0] (ADDRESS = 2Ch, 2Dh, 2Eh, 2Fh)	CLASS SEQUENCE	ICUT_[2:0]	CLASS_[5:0] (ADDRESS = 2Ch, 2Dh, 2Eh, 2Fh)	CLASS SEQUENCE	ICUT_[2:0]
000000	000 (Class 0)	000	010101	333 (Class 3)	000
000001	001	000	010110	004	000
000010	010	HP[2:0]	010111	040	000
000011	011	000	011000	044	000
000100	100	000	011001	400	000
000101	101	HP[2:0]	011010	404	000
000110	110	000	011011	440	000
000111	111 (Class 1)	110	011100	444 (Class 4)	HP[2:0]
001000	002	000	011101	005	000
001001	020	011	011110	050	000
001010	022	000	011111	055	000
001011	200	000	100000	500	000
001100	202	100	100001	505	000
001101	220	000	100010	550	000
001110	222 (Class 2)	111	100011	555 (Class 5)	HP[2:0]
001111	003	000	100100	Reserved	000
010000	030	010	100101	Reserved	000
010001	033	000	100110	Reserved	000
010010	300	000	100111	Reserved	000
010011	303	010	101000	Illegal	000
010100	330	000	101001	Illegal	000

# High-Power, Quad, Monolithic, PSE Controllers for Power over Ethernet

MAX5965A/MAX5965B

**Table 35b. Class Sequence States (continued)**

CLASS_[5:0] (ADDRESS = 2Ch, 2Dh, 2Eh, 2Fh)	CLASS SEQUENCE	ICUT_[2:0]
101010	Illegal	000
101011	Illegal	000
101100	Illegal	000
101101	Illegal	000
101110	Illegal	000
101111	Illegal	000
110000	Reserved	000
110001	Reserved	000
110010	Reserved	000
110011	Reserved	000
110100	Reserved	000

CLASS_[5:0] (ADDRESS = 2Ch, 2Dh, 2Eh, 2Fh)	CLASS SEQUENCE	ICUT_[2:0]
110101	Reserved	000
110110	Reserved	000
110111	Reserved	000
111000	Reserved	000
111001	Reserved	000
111010	Reserved	000
111011	Reserved	000
111100	Reserved	000
111101	Reserved	000
111110	Reserved	000
111111	Reserved	000

When the ENx\_CL6 (R1Ch[7:4]) bits are set, 2-event classification is enabled. Classification is repeated three times and the classification results are set according to Table 35b.

A Class 6 PD is defined by any sequence of the type [00x, 0x0, 0xx, x00, x0x, xx0] where 'x' can be 1, 2, 3, 4, or 5. All sequences made by the same class result define the class itself (for example, 222 defines Class 2). Any other sequence will be considered illegal and coded as 101xxx. For example, a sequence 232 or 203 will be illegal. The illegal sequences all default to class 0. A reset or power-up sets R2Ch = R2Dh = R2Eh = R2Fh = 00h.

The MAX5965A/MAX5965B provide current readout for each port during classification and normal power mode. The current per port information is separated

into 9 bits. They are organized into two consecutive registers for each one of the ports. The information can be quickly retrieved using the autoincrement option of the address pointer. To avoid the LSB register changing while reading the MSB, the information is frozen once the addressing byte points to any of the current readout registers.

During power mode, the current value can be calculated as

$$I_{PORT} = N_{IPD\_} \times 1.953125\text{mA}$$

During classification, the current is

$$I_{CLASS} = N_{IPD\_} \times 0.0975\text{mA}$$

where  $N_{IPD\_}$  is the decimal value of the 9-bit word. The ADC saturates both at full scale and at zero. A reset sets R30h to R37h = 00h.

**Table 36. Current Registers**

ADDRESS = 30h, 31h, 32h, 33h, 34h, 35h, 36h, 37h			DESCRIPTION
SYMBOL	BIT	R/W	
IPD_	7	RO	IPD_[8]
	6	RO	IPD_[7]
	5	RO	IPD_[6]
	4	RO	IPD_[5]
	3	RO	IPD_[4]
	2	RO	IPD_[3]
	1	RO	IPD_[2]
	0	RO	IPD_[1]/IPD_[0]

# High-Power, Quad, Monolithic, PSE Controllers for Power over Ethernet

Table 37. Register Summary

ADDR	REGISTER NAME	R/W	PORT	BIT 7	BIT 6	BIT 5	BIT 4	BIT 3	BIT 2	BIT 1	BIT 0	RESET STATE
<b>INTERRUPTS</b>												
00h	Interrupt	RO	G	SUP_FLT	TSTR_FLT	IMAX_FLT	CL_END	DET_END	LD_DISC	PG_INT_	PEN_INT_	0000,0000
01h	Interrupt Mask	R/W	G	MASK7	MASK6	MASK5	MASK4	MASK3	MASK2	MASK1	MASK0	AAAA,0A00
<b>EVENTS</b>												
02h	Power Event	RO	4321	PG_CHG4	PG_CHG3	PG_CHG2	PG_CHG1	PWEN_CHG4	PWEN_CHG3	PWEN_CHG2	PWEN_CHG1	0000,0000
03h	Power Event CoR	CoR	—									—
04h	Detect Event	RO	4321	CL_END4	CL_END3	CL_END2	CL_END1	DET_END4	DET_END3	DET_END2	DET_END1	0000,0000
05h	Detect Event CoR	CoR	—									—
06h	Fault Event	RO	4321	LD_DISC4	LD_DISC3	LD_DISC2	LD_DISC1	IMAX_FLT4	IMAX_FLT3	IMAX_FLT2	IMAX_FLT1	0000,0000
07h	Fault Event CoR	CoR	—									—
08h	Startup Event	RO	4321	IVC4	IVC3	IVC2	IVC1	STRT_FLT4	STRT_FLT3	STRT_FLT2	STRT_FLT1	0000,0000
09h	Startup Event CoR	CoR	—									—
0Ah	Supply Event	RO	4321	TSD	VDD_OV	VDD_UV	VEE_UVLO	VEE_OV	VEE_UV	OSC_FAIL	VDD_UVLO	—
0Bh	Supply Event CoR	CoR	—									—
<b>STATUS</b>												
0Ch	Port 1 Status	RO	1	Reserved	CLASS1[2]	CLASS1[1]	CLASS1[0]	Reserved	DET_ST1[2]	DET_ST1[1]	DET_ST1[0]	0000,0000
0Dh	Port 2 Status	RO	2	Reserved	CLASS2[2]	CLASS2[1]	CLASS2[0]	Reserved	DET_ST2[2]	DET_ST2[1]	DET_ST2[0]	0000,0000
0Eh	Port 3 Status	RO	3	Reserved	CLASS3[2]	CLASS3[1]	CLASS3[0]	Reserved	DET_ST3[2]	DET_ST3[1]	DET_ST3[0]	0000,0000
0Fh	Port 4 Status	RO	4	Reserved	CLASS4[2]	CLASS4[1]	CLASS4[0]	Reserved	DET_ST4[2]	DET_ST4[1]	DET_ST4[0]	0000,0000
10h	Power Status	RO	4321	PGOOD4	PGOOD3	PGOOD2	PGOOD1	PWR_EN4	PWR_EN3	PWR_EN2	PWR_EN1	0000,0000
11h	Address Input Status	RO	G	Reserved	Reserved	A3	A2	A1	A0	MIDSPAN	AUTO	00A3A2, A1A0MA
<b>CONFIGURATION</b>												
12h	Operating Mode	R/W	4321	P4_M1	P4_M0	P3_M1	P3_M0	P2_M1	P2_M0	P1_M1	P1_M0	AAAA,AAAA
13h	Load Disconnect Detection Enable	R/W	4321	ACD_EN4	ACD_EN3	ACD_EN2	ACD_EN1	DCD_EN4	DCD_EN3	DCD_EN2	DCD_EN1	0000,AAAA
14h	Detection and Classification Enable	R/W	4321	CLASS_EN4	CLASS_EN3	CLASS_EN2	CLASS_EN1	DET_EN4	DET_EN3	DET_EN2	DET_EN1	AAAA,AAAA
15h	Backoff and High-Power Enable	R/W	4321	EN_HP_ALL	EN_HP_CL6	EN_HP_CL5	EN_HP_CL4	BCKOFF4	BCKOFF3	BCKOFF2	BCKOFF1	0000,XXXX
16h	Timing Configuration	R/W	G	RSTR[1]	RSTR[0]	TSTART[1]	TSTART[0]	TFAULT[1]	TFAULT[0]	TDISC[1]	TDISC[0]	0000,0000
17h	Miscellaneous Configuration 1	R/W	G	INT_EN	RSTR_EN	Reserved	Reserved	POFF_CL	CL_DISC	OUT_ISO	HP_TIME	1100,0000
<b>PUSHBUTTONS</b>												
18h	Reserved	R/W	G	Reserved	Reserved	Reserved	Reserved	Reserved	Reserved	Reserved	Reserved	—
19h	Power Enable	WO	4321	PWR_OFF4	PWR_OFF3	PWR_OFF2	PWR_OFF1	PWR_ON4	PWR_ON3	PWR_ON2	PWR_ON1	0000,0000
1Ah	Global	WO	G	CLR_INT	Reserved	Reserved	RESET_IC	RESET_P4	RESET_P3	RESET_P2	RESET_P1	0000,0000
<b>GENERAL</b>												
1Bh	ID	RO	G	ID_CODE[4]	ID_CODE[3]	ID_CODE[2]	ID_CODE[1]	ID_CODE[0]	REV[2]	REV[1]	REV[0]	1100,0000
1Ch	SMODE and 2-Event Enable	CoR or R/W	4321	EN4_CL6	EN3_CL6	EN2_CL6	EN1_CL6	SMODE4	SMODE3	SMODE2	SMODE1	0000,0000
1Dh	Reserved	—	G	Reserved	Reserved	Reserved	Reserved	Reserved	Reserved	Reserved	Reserved	—
1Eh	Watchdog	R/W	G	WDTIME[7]	WDTIME[6]	WDTIME[5]	WDTIME[4]	WDTIME[3]	WDTIME[2]	WDTIME[1]	WDTIME[0]	0000,0000
1Fh	Switch Mode	R/W	4321	EN_WHDOG	WD_INT_EN	Reserved	Reserved	HWMODE4	HWMODE3	HWMODE2	HWMODE1	0000,0000

# High-Power, Quad, Monolithic, PSE Controllers for Power over Ethernet

MAX5965A/MAX5965B

**Table 37. Register Summary (continued)**

ADDR	REGISTER NAME	R/W	PORT	BIT 7	BIT 6	BIT 5	BIT 4	BIT 3	BIT 2	BIT 1	BIT 0	RESET STATE
<b>MAXIM RESERVED</b>												
20h	Reserved	—	G	Reserved	Reserved	Reserved	Reserved	Reserved	Reserved	Reserved	Reserved	—
21h	Reserved	—	G	Reserved	Reserved	Reserved	Reserved	Reserved	Reserved	Reserved	Reserved	—
22h	Reserved	—	G	Reserved	Reserved	Reserved	Reserved	Reserved	Reserved	Reserved	Reserved	—
23h	Program	R/W	4321	Reserved	Reserved	CLC_EN	DET_BY	OSCF_RS	AC_TH[2]	AC_TH[1]	AC_TH[0]	—
24h	High-Power Mode	R/W	G	Reserved	HP[2]	HP[1]	HP[0]	Reserved	Reserved	Reserved	Reserved	0000,0000
25h	Reserved	—	G	Reserved	Reserved	Reserved	Reserved	Reserved	Reserved	Reserved	Reserved	0000,0000
26h	Reserved	—	G	Reserved	Reserved	Reserved	Reserved	Reserved	Reserved	Reserved	Reserved	0000,0000
27h	Reserved	—	G	Reserved	Reserved	Reserved	Reserved	Reserved	Reserved	Reserved	Reserved	—
28h	Reserved	—	G	Reserved	Reserved	Reserved	Reserved	Reserved	Reserved	Reserved	Reserved	—
29h	Miscellaneous Configuration 2	R/W	1234	Reserved	Reserved	Reserved	Reserved	Reserved	LSC_EN	IVEE[1]	IVEE[0]	0000,0000
2Ah	ICUT Registers 1 and 2	R/W	21	Reserved	ICUT2[2]	ICUT2[1]	ICUT2[0]	Reserved	ICUT1[2]	ICUT1[1]	ICUT1[0]	0000,0000
2Bh	ICUT Registers 3 and 4	R/W	43	Reserved	ICUT4[2]	ICUT4[1]	ICUT4[0]	Reserved	ICUT3[2]	ICUT3[1]	ICUT3[0]	0000,0000
<b>CLASSIFICATION STATUS REGISTERS</b>												
2Ch	Port 1 Class	RO	1	Reserved	Reserved	CLASS1[5]	CLASS1[4]	CLASS1[3]	CLASS1[2]	CLASS1[1]	CLASS1[0]	0000,0000
2Dh	Port 2 Class	RO	2	Reserved	Reserved	CLASS2[5]	CLASS2[4]	CLASS2[3]	CLASS2[2]	CLASS2[1]	CLASS2[0]	0000,0000
2Eh	Port 3 Class	RO	3	Reserved	Reserved	CLASS3[5]	CLASS3[4]	CLASS3[3]	CLASS3[2]	CLASS3[1]	CLASS3[0]	0000,0000
2Fh	Port 4 Class	RO	4	Reserved	Reserved	CLASS4[5]	CLASS4[4]	CLASS4[3]	CLASS4[2]	CLASS4[1]	CLASS4[0]	0000,0000
<b>CURRENT REGISTER</b>												
30h	Current Port 1 (MSB)	RO	1	IPD1[8]	IPD1[7]	IPD1[6]	IPD1[5]	IPD1[4]	IPD1[3]	IPD1[2]	IPD1[1]	0000,0000
31h	Current Port 1 (LSB)	RO	1	Reserved	Reserved	Reserved	Reserved	Reserved	Reserved	Reserved	IPD1[0]	0000,0000
32h	Current Port 2 (MSB)	RO	2	IPD2[8]	IPD2[7]	IPD2[6]	IPD2[5]	IPD2[4]	IPD2[3]	IPD2[2]	IPD2[1]	0000,0000
33h	Current Port 2 (LSB)	RO	2	Reserved	Reserved	Reserved	Reserved	Reserved	Reserved	Reserved	IPD2[0]	0000,0000
34h	Current Port 3 (MSB)	RO	3	IPD3[8]	IPD3[7]	IPD3[6]	IPD3[5]	IPD3[4]	IPD3[3]	IPD3[2]	IPD3[1]	0000,0000
35h	Current Port 3 (LSB)	RO	3	Reserved	Reserved	Reserved	Reserved	Reserved	Reserved	Reserved	IPD3[0]	0000,0000
36h	Current Port 4 (MSB)	RO	4	IPD4[8]	IPD4[7]	IPD4[6]	IPD4[5]	IPD4[4]	IPD4[3]	IPD4[2]	IPD4[1]	0000,0000
37h	Current Port 4 (LSB)	RO	4	Reserved	Reserved	Reserved	Reserved	Reserved	Reserved	Reserved	IPD4[0]	0000,0000

\*UV and UVLO bits of V<sub>EE</sub> and V<sub>DD</sub> asserted depends on the order V<sub>EE</sub> and V<sub>DD</sub> supplies are brought up.

A = AUTO pin state before reset.

M = MIDSPAN state before reset.

A3...0 = ADDRESS input states before reset.

# High-Power, Quad, Monolithic, PSE Controllers for Power over Ethernet

## Applications Information

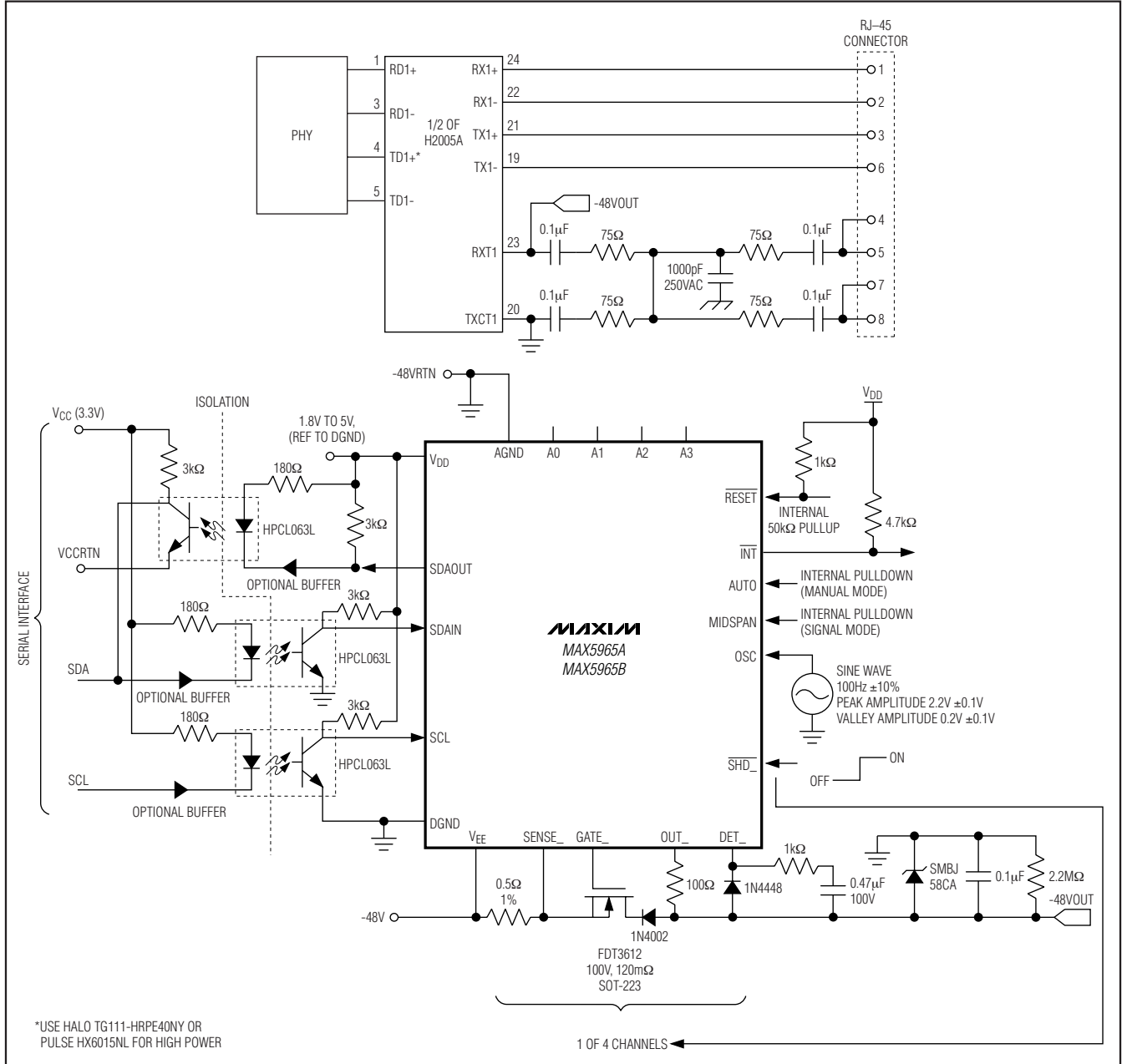

Figure 13. PoE System Block Diagram



# High-Power, Quad, Monolithic, PSE Controllers for Power over Ethernet

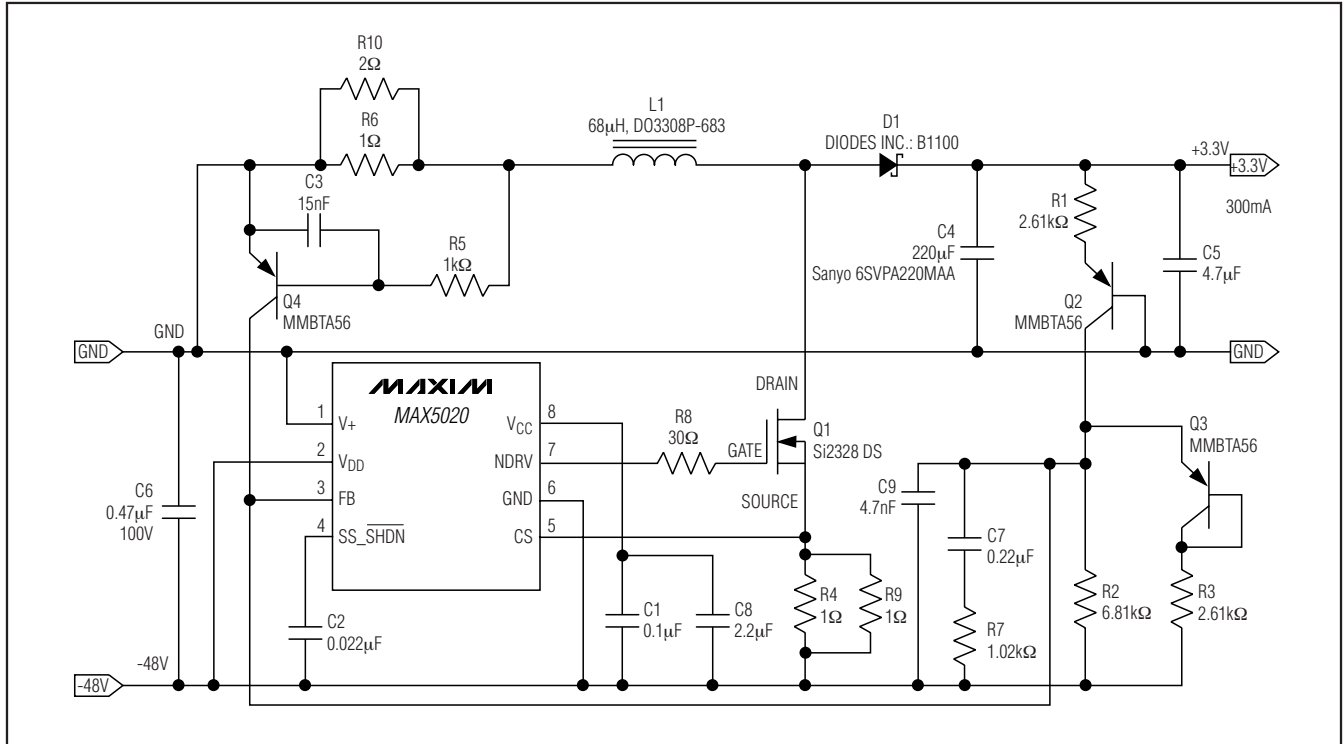

Figure 15. -48V to +3.3V (300mA) Boost Converter Solution for VDIG

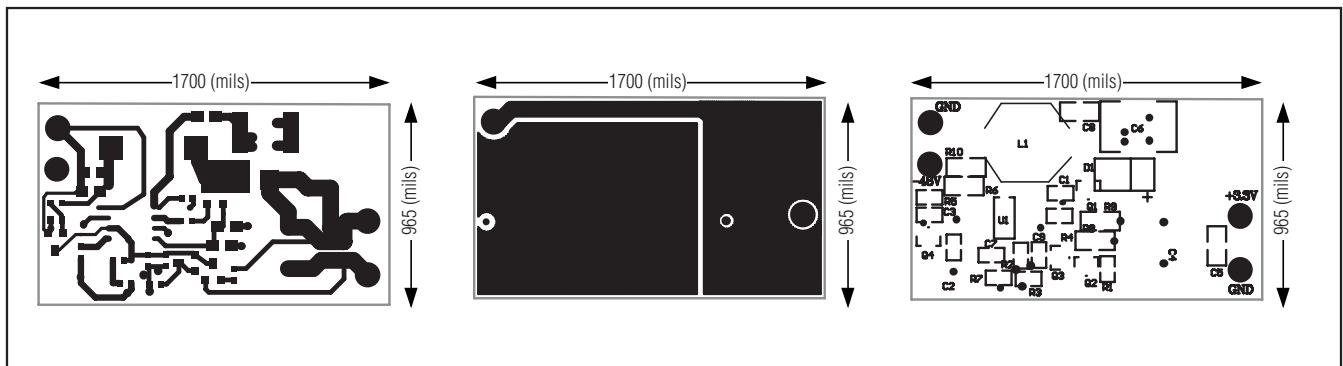

Figure 16. Layout Example for Boost Converter Solution for VDIG

# High-Power, Quad, Monolithic, PSE Controllers for Power over Ethernet

**MAX5965A/MAX5965B**

## Component List for VDIG Supply

DESIGNATION	DESCRIPTION
C1	0.1 $\mu$ F, 25V ceramic capacitor
C2	0.022 $\mu$ F, 25V ceramic capacitor
C3	15nF, 25V ceramic capacitor
C4	220 $\mu$ F capacitor Sanyo 6SVPA220MAA
C5	4.7 $\mu$ F, 16V ceramic capacitor
C6	0.47 $\mu$ F, 100V ceramic capacitor
C7	0.22 $\mu$ F, 16V ceramic capacitor
C8	2.2 $\mu$ F, 16V ceramic capacitor
C9	4.7nF, 16V ceramic capacitor
D1	B1100 100V Schottky diode
L1	68 $\mu$ H inductor Coilcraft DO3308P-683 or equivalent

DESIGNATION	DESCRIPTION
Q1	Si2328DS Vishay n-channel MOSFET, SOT23
Q2, Q3, Q4	MMBTA56 small-signal PNP
R1, R3	2.61k $\Omega$ $\pm$ 1% resistors
R2	6.81k $\Omega$ $\pm$ 1% resistor
R4, R6, R9	1 $\Omega$ $\pm$ 1% resistors
R5	1k $\Omega$ $\pm$ 1% resistor
R7	1.02k $\Omega$ $\pm$ 1% resistor
R8	30 $\Omega$ $\pm$ 1% resistor
R10	2 $\Omega$ $\pm$ 1% resistor
U1	High-voltage PWM IC MAX5020ESA (8-pin SO)

## Pin Configuration

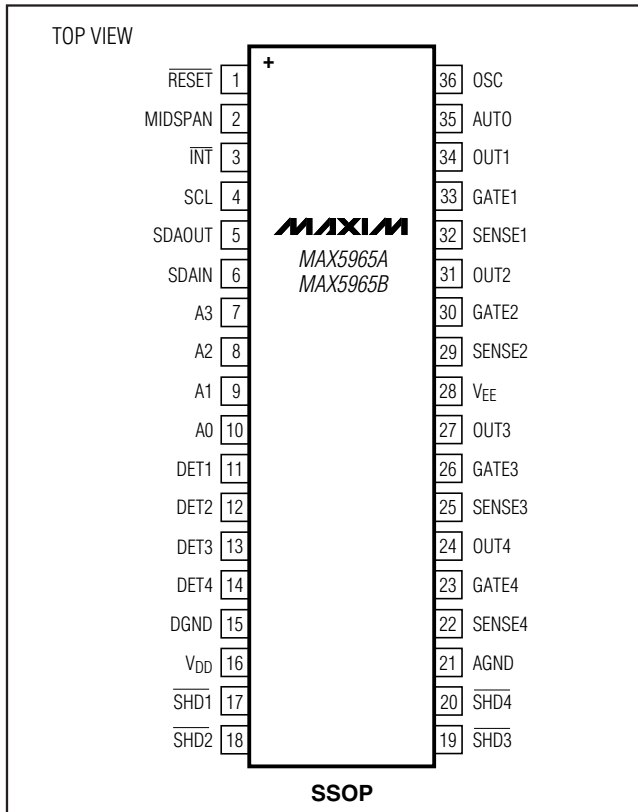

# High-Power, Quad, Monolithic, PSE Controllers for Power over Ethernet

## Typical Operating Circuits

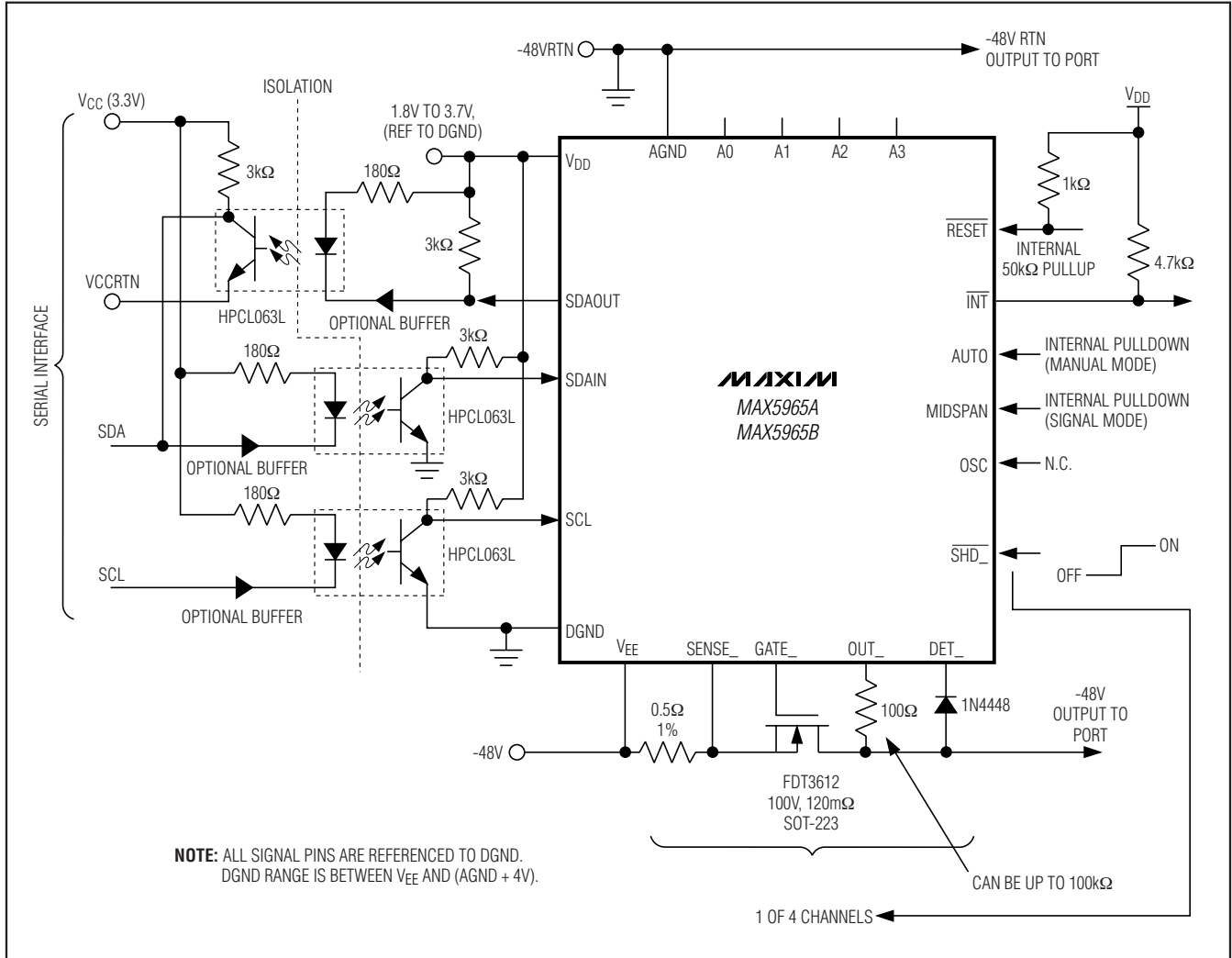

Typical Operating Circuit 1 (without AC Load Removal Detection)

# High-Power, Quad, Monolithic, PSE Controllers for Power over Ethernet

## Typical Operating Circuits (continued)

**MAX5965A/MAX5965B**

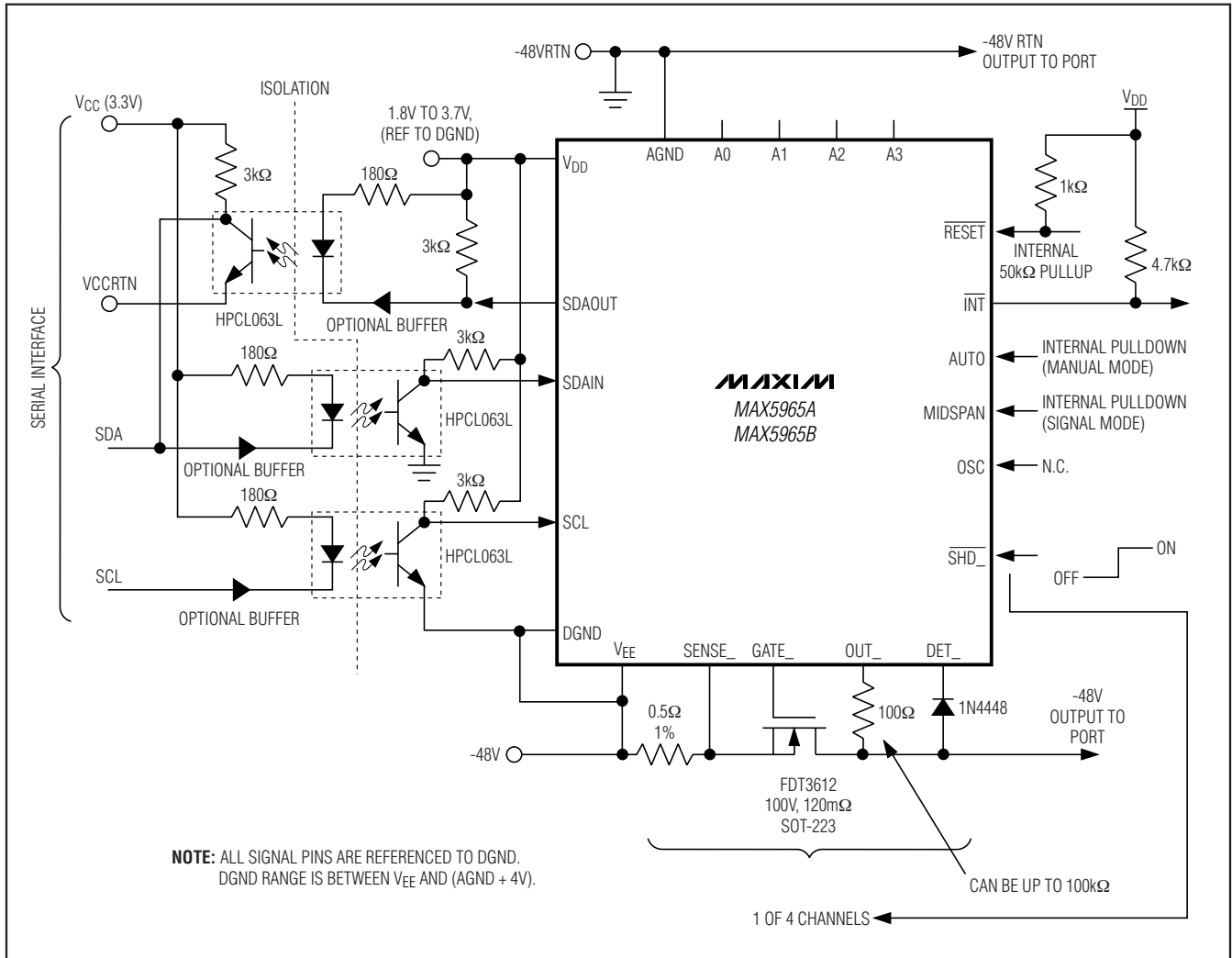

Typical Operating Circuit 2 (without AC Load Removal Detection); Alternative DGND Connection



# High-Power, Quad, Monolithic, PSE Controllers for Power over Ethernet

## Revision History

REVISION NUMBER	REVISION DATE	DESCRIPTION	PAGES CHANGED
0	7/09	Initial release	—
1	1/10	Revised <i>Features</i> , <i>Register Map</i> and <i>Description</i> section, and Tables 32 and 37.	3, 5

MAX5965A/MAX5965B

Maxim cannot assume responsibility for use of any circuitry other than circuitry entirely embodied in a Maxim product. No circuit patent licenses are implied. Maxim reserves the right to change the circuitry and specifications without notice at any time.

Maxim Integrated Products, 120 San Gabriel Drive, Sunnyvale, CA 94086 408-737-7600 \_\_\_\_\_ 53