Transition Socket Specifications

Introduction

Transition sockets are devices that allow MPLAB® ICE 2000 and MPLAB ICE 4000 device adapters to interface to sockets on customer products that differ from the standard emulator adapter connection.

Embedded microcontrollers/microprocessors come in many different types of IC packages, (i.e., DIP, PLCC, SOIC, SSOP, MQFP, etc.). Typically, development cycle components are EPROM based and, as a result, are provided in larger windowed package formats such as DIP or PLCC. Production components are primarily preprogrammed ROM, OTP or Flash-based and are often in very compact SOIC, SSOP, MQFP or PQFP package formats.

The MPLAB ICE solution is transition sockets. A transition socket is specifically designed to provide compatibility between two differing types of IC package formats.

Transition sockets are typically composed of two parts: the DIP adapter socket and the SOIC/SSOP header. The DIP adapter socket is designed to plug into the emulator system's DIP device adapter on one side and the header on the other. The header is then soldered down to the target application.

The QFP Adapter is a single part soldered directly to the target application and fits into the QFP device adapter.

Why should I use transition sockets in my product design?

There are two very significant advantages to using transition sockets:

1. Shorter product development cycle.
2. Reduced expense in the design, layout and prototype testing.

A typical product design cycle has two important phases: the prototype design phase and the production design phase. Traditionally, these phases were different simply because the prototype used a microcontroller with a different package type. However, with the availability of the transition sockets, the prototype design can be identical to the production design because a transition socket can be used to bridge the microcontroller package differences.

What transition sockets are currently available?

Microchip Technology currently offers the transition sockets listed in the Table of Contents following this introductory section.

The *Product Line Card* (DS00148) lists the transition sockets available for each device adapter of the MPLAB ICE 2000 or 4000 System. For more on MPLAB ICE 2000 device adapters, see the *MPLAB ICE 2000 Processor Module and Device Adapter Specification* (DS51140). For more on MPLAB ICE 4000 device adapters, see the *MPLAB ICE 4000 Processor Module and Device Adapter Specification* (DS51298).

Please check the Microchip web site (www.microchip.com) for the most current version of all documents.

How can I obtain maximum benefit from the use of transition sockets?

Attention to component placement should be considered to provide adequate clearance for the transition socket interface to the PCB footprint. This is especially true for any tall components such as connector headers, radial components or voltage regulators. Refer to the transition socket mechanical drawings for dimensions.

Transition Sockets

Transition socket applications – comments and suggestions

Attention to component placement should be considered in mating the adapter sockets to the SOIC/SSOP headers. If visual alignment is difficult in your application, c-shaped end brackets have been included to aid in header-to-adapter socket alignment. Clip the brackets onto the SOIC/SSOP header.

The placement of via's around the Surface Mount Technology (SMT) layout area should be examined. Via's immediately adjacent to the end of a SMT pad may inadvertently come into contact with the header leads. Via's should be placed along the centerline of the SMT pad to lessen the chance of pin to pin shorts while soldering.

The SOIC header is designed for SOIC body width of 0.300-inch, the adapter leads should be cut to fit the 0.150-inch and 0.208-inch SOIC body widths.

For information on packaging dimensions, please refer to DS00049.

MPLAB® ICE

NOTES:

Table of Contents

PDIP Transition Socket

XLT28XP

28-lead DIP 0.300-inch Male to 0.600-inch Female Adapter Socket	10
--	----

SOIC Transition Socket

XLT08SO

8-lead DIP to 0.050-inch Adapter Socket	12
8-lead SOIC Header	13

XLT14SO

14-lead DIP to 0.050-inch Adapter Socket	14
14-lead SOIC Header	15

XLT18SO

18-lead DIP to 0.050-inch Adapter Socket	16
18-lead SOIC Header	17

XLT20SO1

20-lead DIP to 0.050-inch Adapter Socket	18
20-lead SOIC Header	19

XLT28SO

28-lead DIP to 0.050-inch Adapter Socket	20
28-lead SOIC Header	21

SSOP Transition Socket

XLT14SS

14-lead DIP to 0.8 mm Adapter Socket	24
14-lead SSOP Header	25

MPLAB® ICE

XLT20SS

18-lead DIP to 0.8 mm Adapter Socket 26

20-lead SSOP Header 27

XLT20SS1

20-lead DIP to 0.8 mm Adapter Socket 28

20-lead SSOP Header 29

XLT28SS, XLT28SS2

28-lead DIP to 0.8 mm Adapter Socket 30

28-lead SSOP Header 31

MQFP/TQFP Transition Socket

XLT44PT

44-lead QFP to 0.8 mm Adapter Socket Top View 34

44-lead QFP to 0.8 mm Adapter Socket Side View ... 35

XLT64PT1, XLT64PT2, XLT80PT

64/80-lead QFP to 0.5 mm Adapter Socket
Top View 36

64/80-lead QFP to 0.5 mm Adapter Socket
Side View 37

XLT64PT3

64-lead QFP to 0.8mm Adapter Socket Top View 38

64-lead QFP to 0.8mm Adapter Socket Side View 39

PLCC Transition Socket

XLT44L2, XLT68L1, XLT84L1

44/68/84-lead Transition Socket Top View 42

44/68/84-lead Transition Socket Side View 43

Transition Sockets

DFN/QFN Transition Sockets

XLT08DFN

8-lead DIP to 0.400-inch Adapter Socket 46

XLT28QFN

28-lead DIP to 0.600-inch Adapter Socket 47

XLT28QFN2

18-lead DIP to 0.600-inch Adapter Socket 48

XLT44QFN

40-lead DIP to 0.600-inch Adapter Socket 49

44-lead QFN Header 50

MPLAB® ICE

NOTES:

Transition Sockets

PDIP Transition Socket

A PDIP transition socket and associated hardware is shown in Figure 1.

FIGURE 1: PDIP Transition Socket

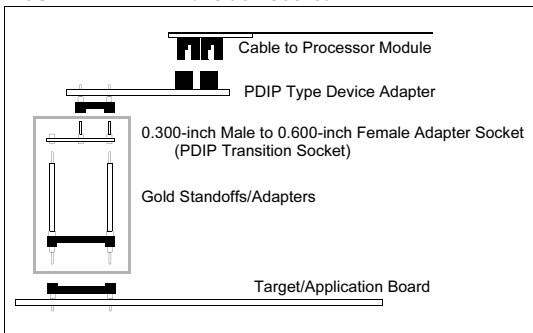

The PDIP transition socket is a 0.300-inch Male to 0.600-inch Female adapter socket.

Microchip offers the following PDIP transition socket:

- XLT28XP: One 28-lead PDIP adapter socket and two 28-lead gold stand-offs

See the drawings in this section for layout dimensions.

XLT28XP

28-lead DIP 0.300-inch Male to 0.600-inch Female Adapter Socket

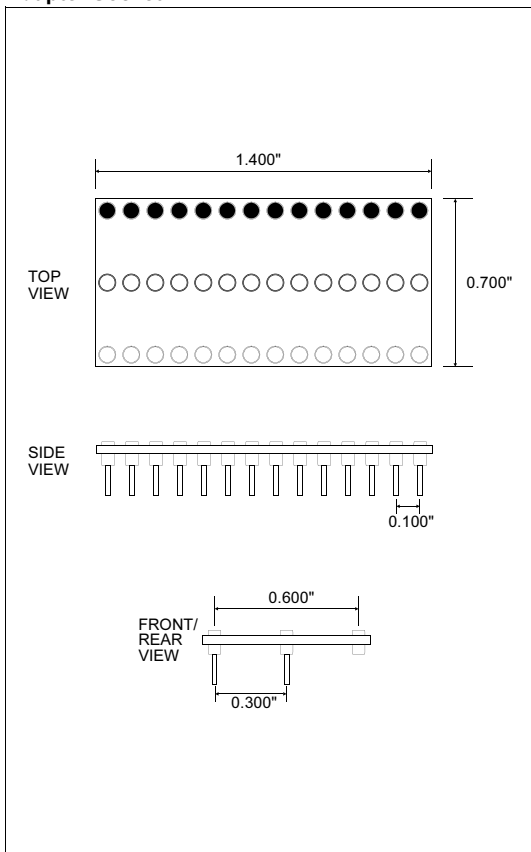

Transition Sockets

SOIC Transition Socket

An SOIC transition socket and associated hardware is shown in Figure 2.

FIGURE 2: SOIC Transition Socket

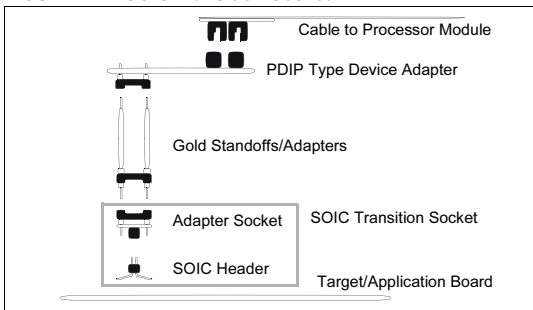

There are two components of the SOIC transition socket.

1. Adapter socket that connects to the PDIP device adapter.
2. SOIC header that is to be soldered down to the target application.

Microchip offers the following SOIC transition sockets:

- XLT08SO: One adapter socket and three 8-lead SOIC headers
- XLT14SO: One adapter socket and three 14-lead SOIC headers
- XLT18SO: One adapter socket and three 18-lead SOIC headers
- XLT20SO1: One adapter socket and three 20-lead SOIC headers
- XLT28SO: One adapter socket and three 28-lead SOIC headers

See the drawings in this section for layout dimensions.

Note: The SOIC header is designed for SOIC body width of 0.300 inch. The adapter leads should be cut to fit the 0.150-inch and 0.208-inch SOIC body widths.

XLT08SO

8-lead DIP to 0.050-inch Adapter Socket

TOP
VIEW

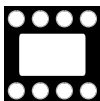

BOTTOM
VIEW

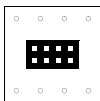

SIDE
VIEW



FRONT/
REAR
VIEW



Transition Sockets

8-lead SOIC Header

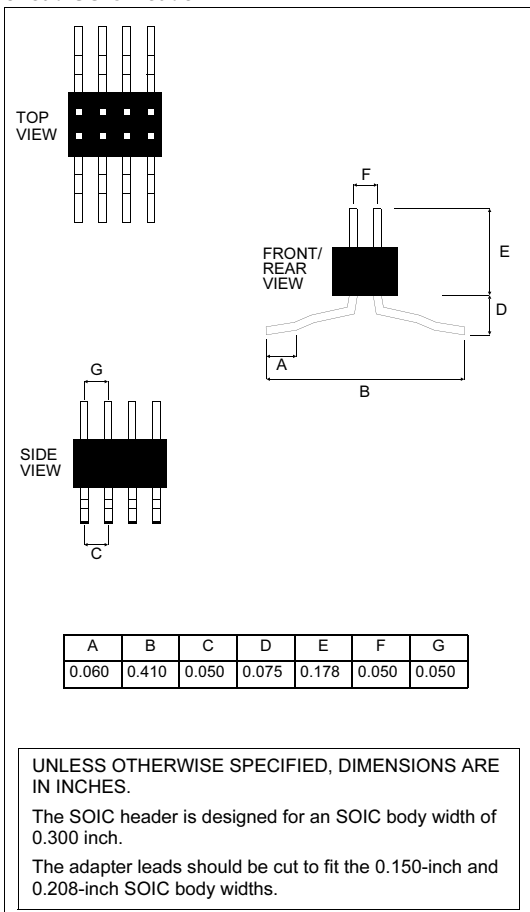

XLT14SO

14-lead DIP to 0.050-inch Adapter Socket

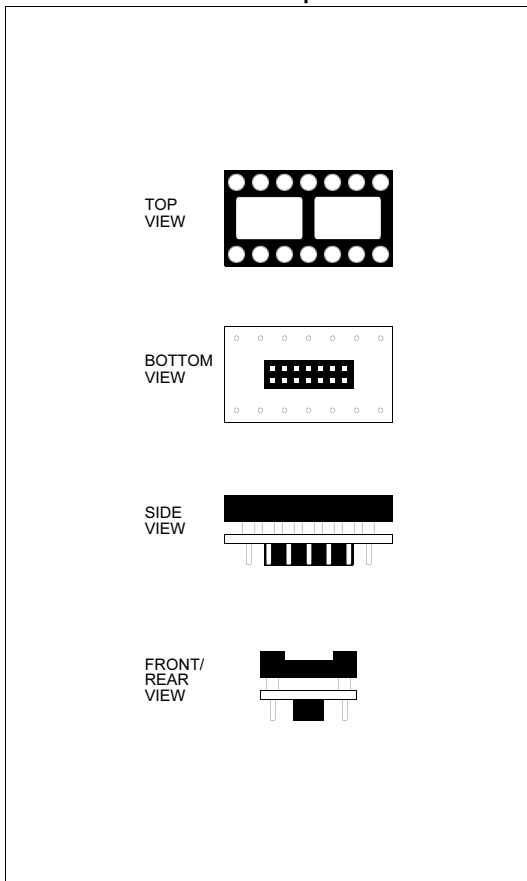

Transition Sockets

14-lead SOIC Header

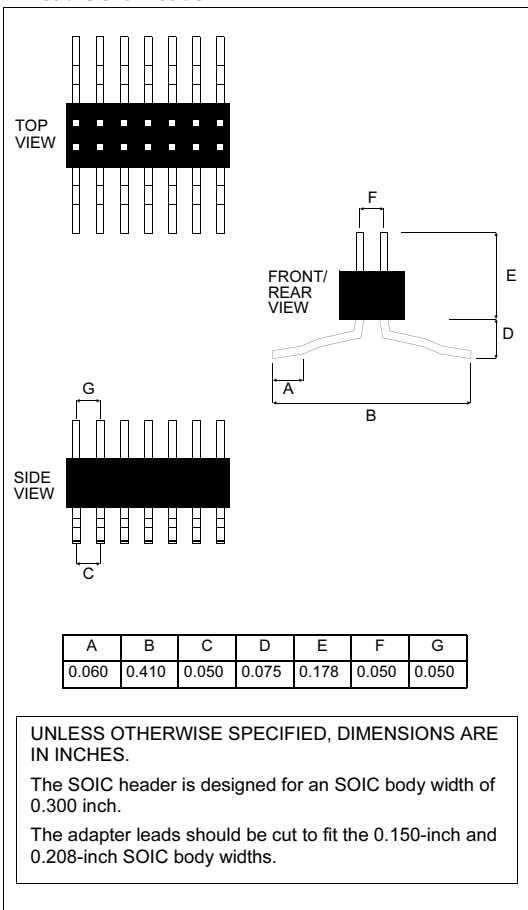

XLT18SO

18-lead DIP to 0.050-inch Adapter Socket

TOP
VIEW

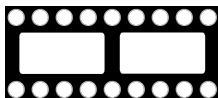

BOTTOM
VIEW

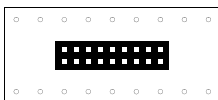

SIDE
VIEW



FRONT/
REAR
VIEW



Transition Sockets

18-lead SOIC Header

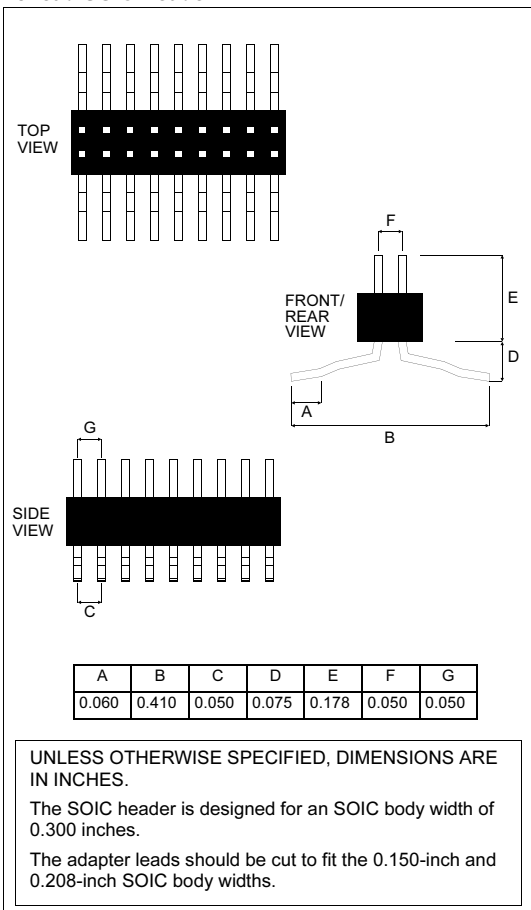

XLT20SO1

20-lead DIP to 0.050-inch Adapter Socket

TOP
VIEW

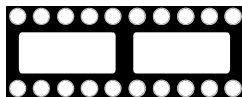

BOTTOM
VIEW

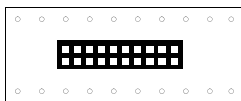

SIDE
VIEW



FRONT/
REAR
VIEW



Transition Sockets

20-lead SOIC Header

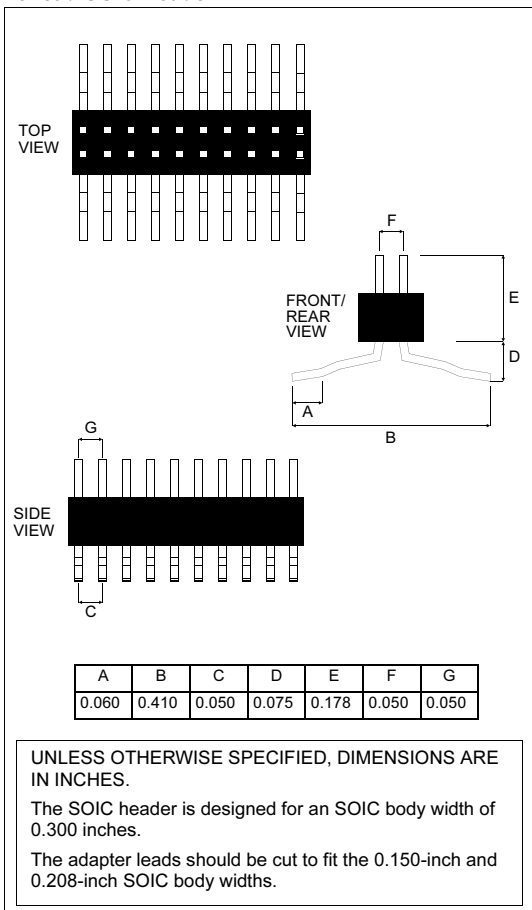

XLT28SO

28-lead DIP to 0.050-inch Adapter Socket

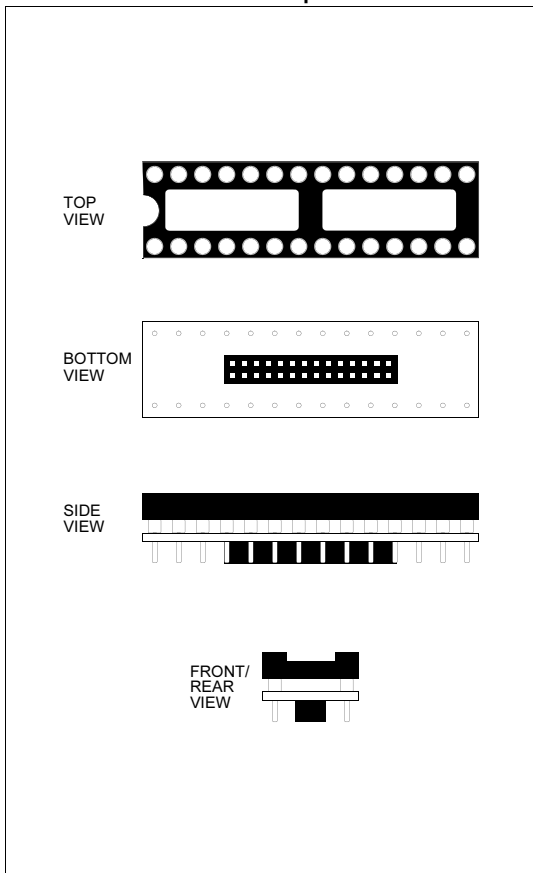

Transition Sockets

28-lead SOIC Header

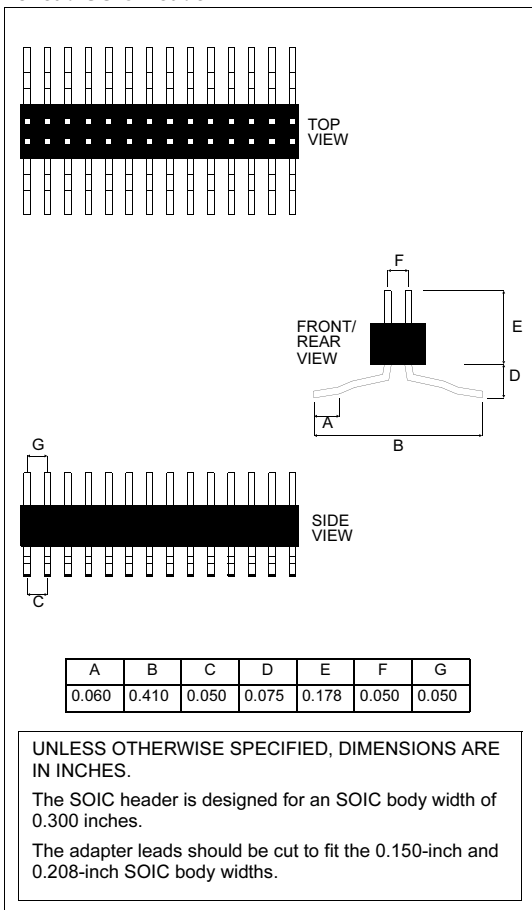

SSOP Transition Socket

An SSOP transition socket and associated hardware is shown in Figure 3.

FIGURE 3: SSOP Transition Socket

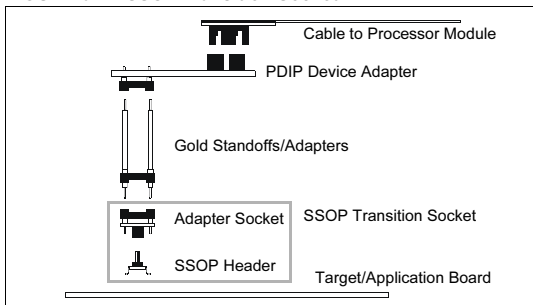

The SSOP transition sockets are similar to the SOIC transition sockets. There are two parts to the SSOP transition socket:

1. Adapter socket that connects to the PDIP device adapter.
2. SSOP header that gets soldered down to the target application.

Note: To keep the leads straight during assembly and shipping, the SSOP headers are shipped with break-away tabs attached to the leads. Please remove the break-away tabs before applying power to the target system. Be careful not to bend the leads prior to soldering to the target application.

Transition Sockets

Microchip offers the following SSOP transition sockets:

- XLT14SS: One adapter socket and three 14-lead SSOP headers
- XLT20SS: One adapter socket and three 20-lead SSOP headers
- XLT20SS1: One adapter socket and three 20-lead SSOP headers
- XLT28SS: One adapter socket and three 28-lead SSOP headers
- XLT28SS2: One adapter socket and three 28-lead SSOP headers for PIC16C55/57

See the drawings in this section for layout dimensions and clearances for tall components.

XLT14SS

14-lead DIP to 0.8 mm Adapter Socket

TOP
VIEW



BOTTOM
VIEW

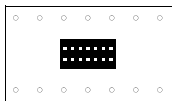

SIDE
VIEW

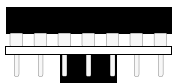

FRONT/
REAR
VIEW

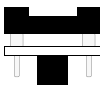

Transition Sockets

14-lead SSOP Header

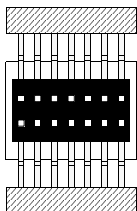

Shipped with break-away tabs attached to leads

Remove prior to providing power

* Top drawing shown with clip-on shrouds installed

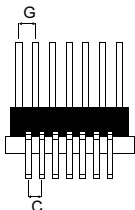
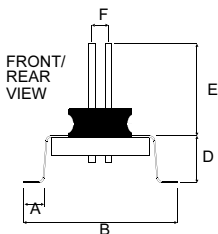

A	B	C	D	E	F	G
0.035	0.300	0.023	0.080	0.186	0.043	0.025

UNLESS OTHERWISE SPECIFIED, DIMENSIONS ARE IN INCHES.

Break away tabs are to be removed prior to providing power.

XLT20SS

18-lead DIP to 0.8 mm Adapter Socket

TOP
VIEW



BOTTOM
VIEW

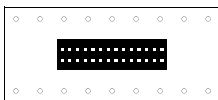

SIDE
VIEW

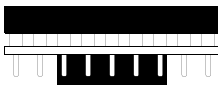

FRONT/
REAR
VIEW

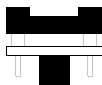

Transition Sockets

20-lead SSOP Header

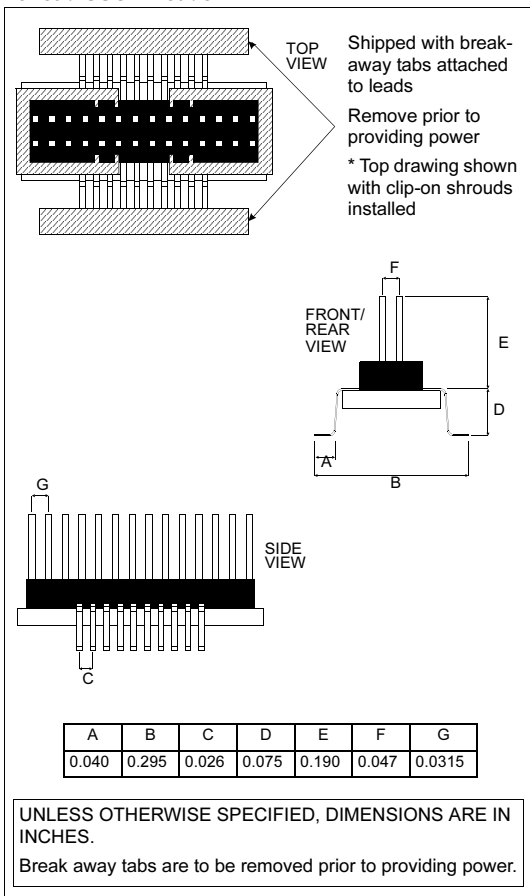

XLT20SS1

20-lead DIP to 0.8 mm Adapter Socket

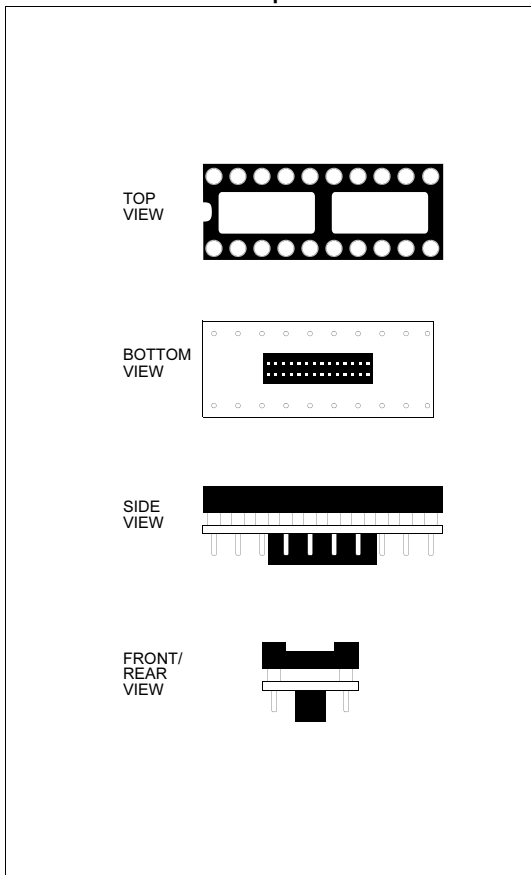

Transition Sockets

20-lead SSOP Header

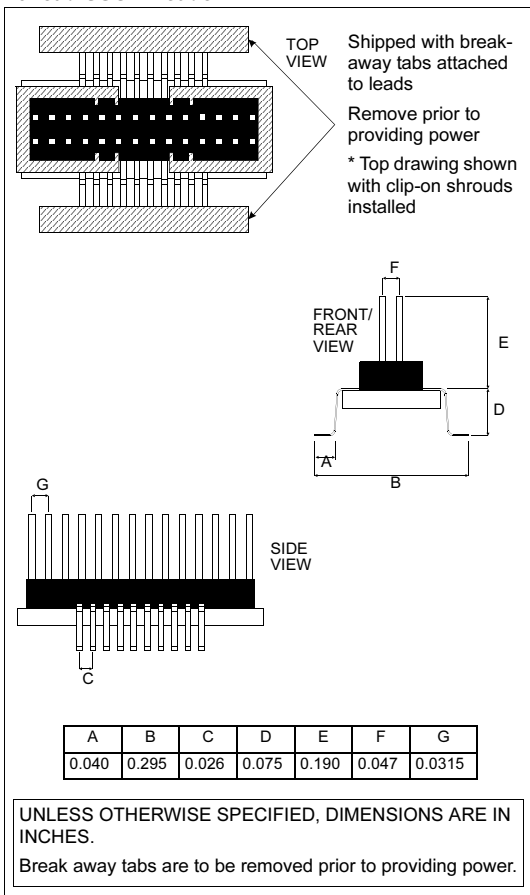

XLT28SS, XLT28SS2

28-lead DIP to 0.8 mm Adapter Socket

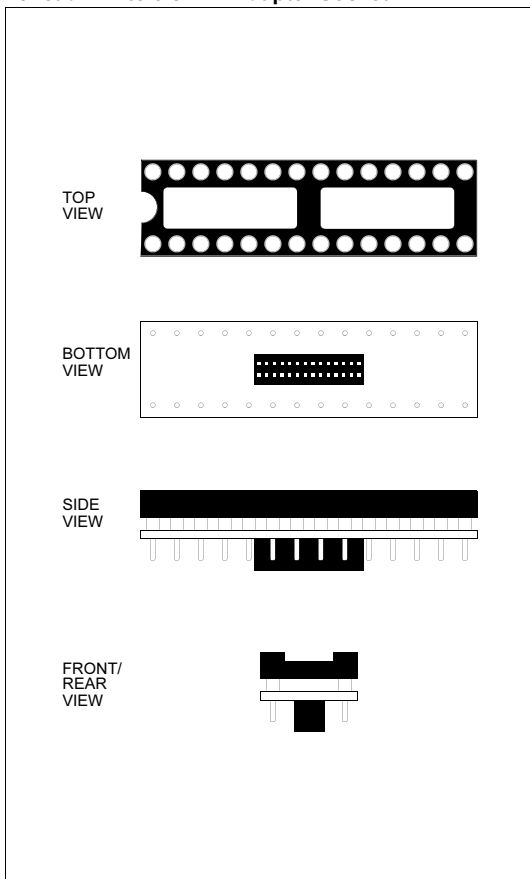

Transition Sockets

28-lead SSOP Header

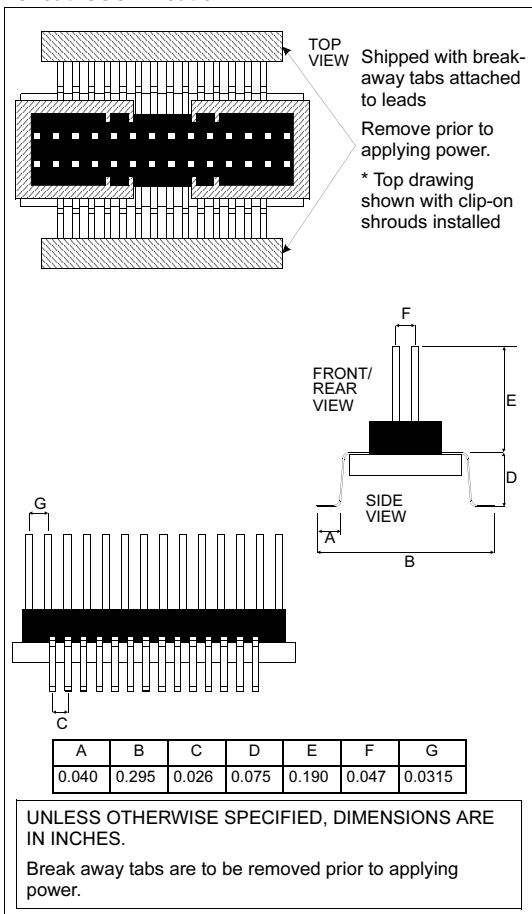

MQFP/TQFP Transition Socket

An MQFP/TQFP transition socket and associated hardware is shown in Figure 4.

FIGURE 4: MQFP/TQFP Transition Socket

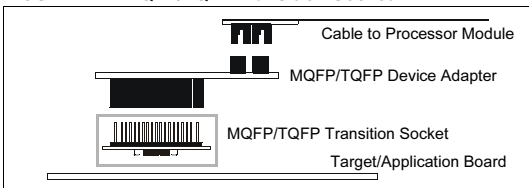

The MQFP/TQFP transition socket is required for use along with the MQFP/TQFP device adapters. The device adapter is equipped with four socket strips that interface with the transition socket.

Note: To avoid solder bridging, do not place via's within 0.025-inch of the MQFP/TQFP footprint. Also, any via's near the MQFP/TQFP should be directly on the centerline of the pad.

Microchip offers the following MQFP/TQFP transition sockets:

- XLT44PT: One 44-lead MQFP/TQFP transition socket, 0.80 mm
- XLT64PT1: One 64-lead MQFP/TQFP transition socket, 0.5 mm (PIC16C92X)
- XLT64PT2: One 64-lead MQFP/TQFP transition socket, 0.5 mm (PIC17CXXX)
- XLT64PT3: One 64-lead MQFP/TQFP transition socket, 0.8 mm (dsPIC30F)
- XLT80PT: One 80-lead MQFP/TQFP transition socket, 0.5 mm

Transition Sockets

Note: The XLT64PT1 for the PIC16C92X is not symmetrical. Please note Pin 1 orientation prior to soldering to the target system.

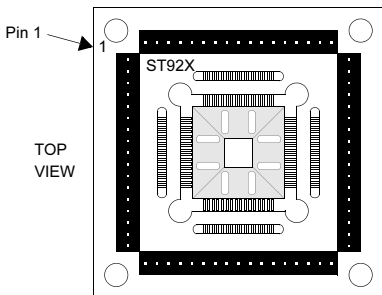

See the drawings in this section for layout dimensions and clearances for tall components.

TQFP Transition Socket Soldering Tips

- Before soldering, consider keeping the break away tabs in place during soldering.
- Use controlled soldering iron tip temperatures between 300°C and 325°C (570°F to 615°F)
- If possible, use a PACE mini wave soldering iron tip or an equivalent tip design.
- Plan to solder one (1 of 4) side first, then the opposite side, then remaining two sides.
- Soldering iron tip movement should be in direction of the leads (backward and forward), not across the leads; dragging the tip across the leads may cause lead damage.
- Use generous amounts of soldering flux to aid in the solder flow action.
- If the breakaway tabs are removed after soldering (using a dental pick or equivalent), any solder bridging between leads can be repaired by simply gently touching the soldering tip to the lead tip.

Remember the 64- and 80-pin TQFP headers are very delicate and can be damaged!

XLT44PT

44-lead QFP to 0.8 mm Adapter Socket Top View

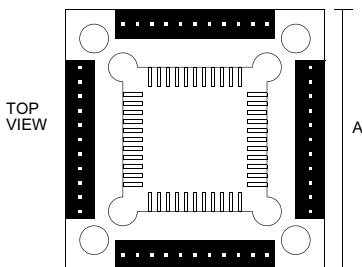

A
0.90

UNLESS OTHERWISE SPECIFIED, DIMENSIONS
ARE IN INCHES.

Transition Sockets

44-lead QFP to 0.8 mm Adapter Socket Side View

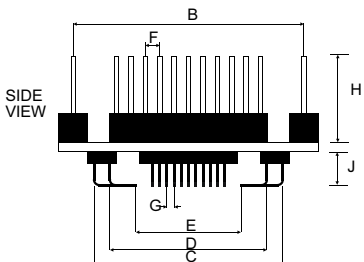

B	C	D	E	F	G	H	J
0.80	0.65	0.55	0.365	0.05	0.80 mm	0.275	0.130

UNLESS OTHERWISE SPECIFIED, DIMENSIONS
ARE IN INCHES.

XLT64PT1, XLT64PT2, XLT80PT

64/80-lead QFP to 0.5 mm Adapter Socket Top View

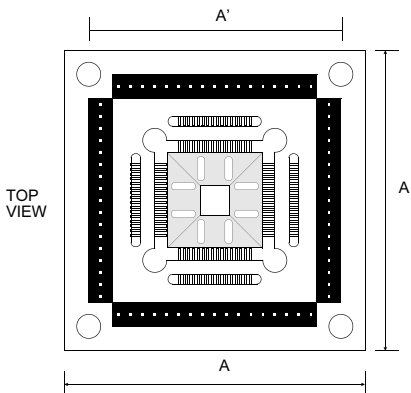

	A	B
XLT64PT1	1.25	1.050 +/- 0.005
XLT64PT2	1.25	1.050 +/- 0.005
XLT80PT	1.45	N/A

UNLESS OTHERWISE SPECIFIED, DIMENSIONS ARE IN INCHES.

Drawing shown is for 64-lead.

This drawing shown with break away tabs attached to the leads.

Break away tabs are to be removed prior to applying power.

Transition Sockets

64/80-lead QFP to 0.5 mm Adapter Socket Side View

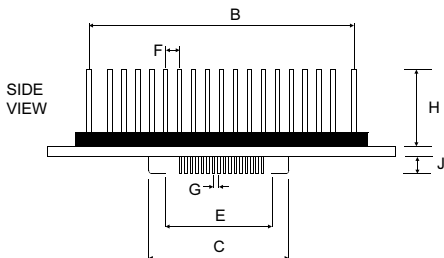

	B	C	E	F	G	H	J
XLT64PT1	0.95	0.500	0.400	0.05	0.5 mm	0.275	0.095
XLT64PT2	0.95	0.500	0.400	0.05	0.5 mm	0.275	0.095
XLT80PT	1.15	0.575	0.475	0.05	0.5 mm	0.275	0.095

UNLESS OTHERWISE SPECIFIED, DIMENSIONS ARE IN INCHES.

Drawing shown is for 64-lead.

Break away tabs are to be removed prior to applying power.

XLT64PT3

64-lead QFP to 0.8mm Adapter Socket Top View

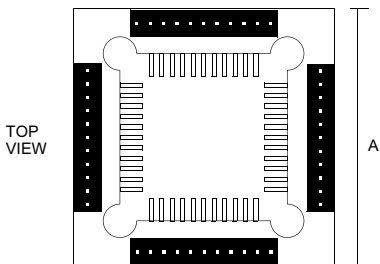

A
1.05

UNLESS OTHERWISE SPECIFIED, DIMENSIONS
ARE IN INCHES.

Transition Sockets

64-lead QFP to 0.8mm Adapter Socket Side View

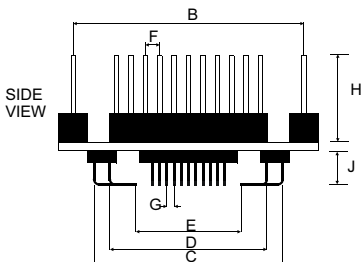

B	C	D	E	F	G	H	J
0.95	0.80	0.70	0.51	0.05	0.80 mm	0.275	0.140

UNLESS OTHERWISE SPECIFIED, DIMENSIONS
ARE IN INCHES.

PLCC Transition Socket

A PLCC transition socket and associated hardware is shown in Figure 5.

FIGURE 5: PLCC Transition Socket

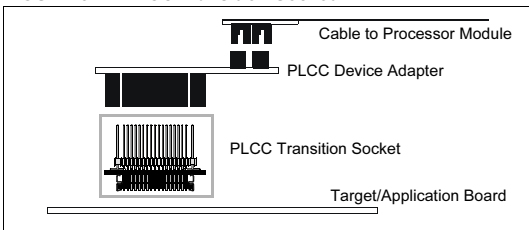

The PLCC transition socket is required for use along with the PLCC device adapters. The DAF18-1 device adapter is equipped with eight socket strips that interface with one of two transition sockets. The DAF18-3 device adapter is equipped with four socket strips that interface with one transition socket.

The PLCC transition sockets are designed with a threaded insert in the center of the footprint so that a 4/40 screw can securely fasten the transition socket to the device adapter.

The PLCC transition sockets are designed to be soldered to the target PCB PLCC surface mount pattern or inserted into a PLCC socket on the target PCB.

Note: To avoid solder bridging, do not place via's within 0.025-inch of the PLCC footprint. Also, any via's near the PLCC should be directly on the centerline of the pad.

Microchip offers the following PLCC transition sockets:

- XLT44L2: One 44-lead PLCC transition socket – used exclusively with the DAF18-3 device adapter.
- XLT68L1: One 68-lead PLCC transition socket
- XLT84L1: One 84-lead PLCC transition socket

Transition Sockets

Recommended PCB Layout

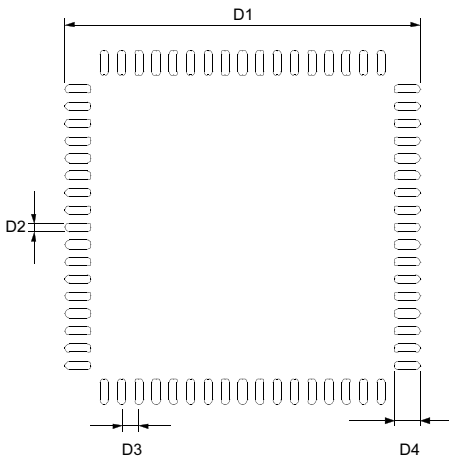

	D1	D2	D3	D4
44-lead	0.865	0.024	0.050	0.074
68-lead	1.025	0.024	0.050	0.074
84-lead	1.225	0.024	0.050	0.074

UNLESS OTHERWISE SPECIFIED, DIMENSIONS ARE IN INCHES.

Drawing shown is for 68-lead.

XLT44L2, XLT68L1, XLT84L1

44/68/84-lead Transition Socket Top View

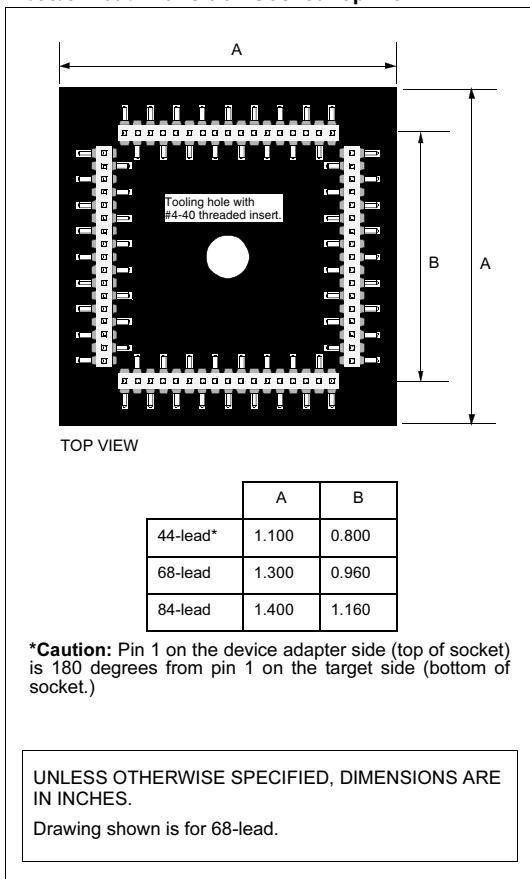

Transition Sockets

44/68/84-lead Transition Socket Side View

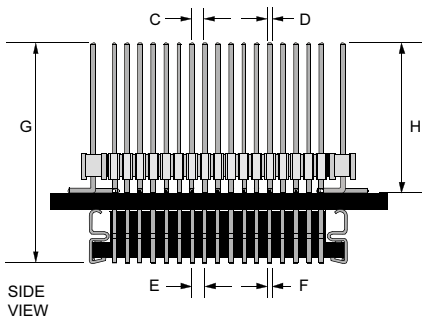

	C	D	E	F	G	H
44-lead	0.050	0.018	0.050	0.017	0.850	0.588
68-lead	0.050	0.018	0.050	0.017	0.849	0.580
84-lead	0.050	0.018	0.050	0.017	0.849	0.580

UNLESS OTHERWISE SPECIFIED, DIMENSIONS ARE
IN INCHES.

Drawing shown is for 68-lead.

DFN/QFN Transition Sockets

A DFN/QFN transition sockets and associated hardware are shown in Figure 6 and Figure 7.

FIGURE 6: DFN/QFN Transition Socket

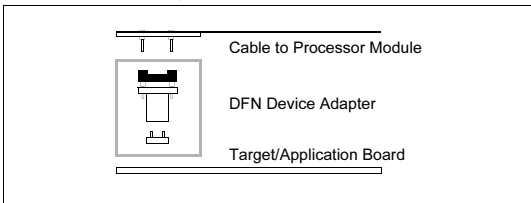
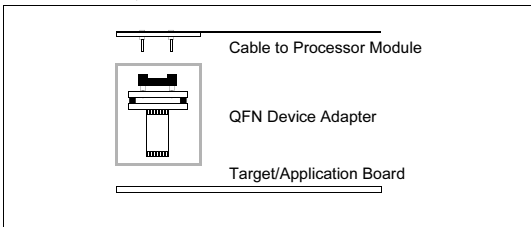

FIGURE 7: QFN Transition Socket



Microchip offers the following DFN/QFN transition sockets:

- XLT08DFN: One 8-lead DFN transition socket
- XLT28QFN: One 28-lead QFN transition socket
- XLT28QFN2: One 28-lead QFN transition socket
- XLT44QFN: One 44-lead QFN transition socket

See the drawings in this section for layout dimensions.

Transition Sockets

Recommended PCB Layout

8-Pin DFN

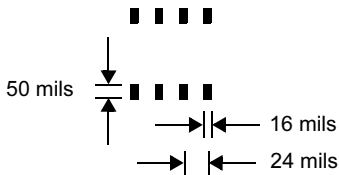

28-Pin QFN

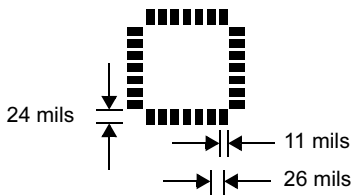

44-Pin QFN

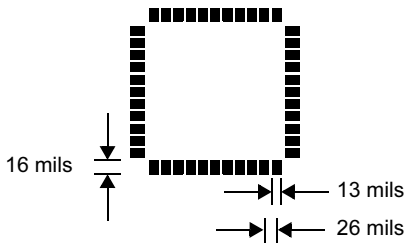

XLT08DFN

8-lead DIP to 0.400-inch Adapter Socket

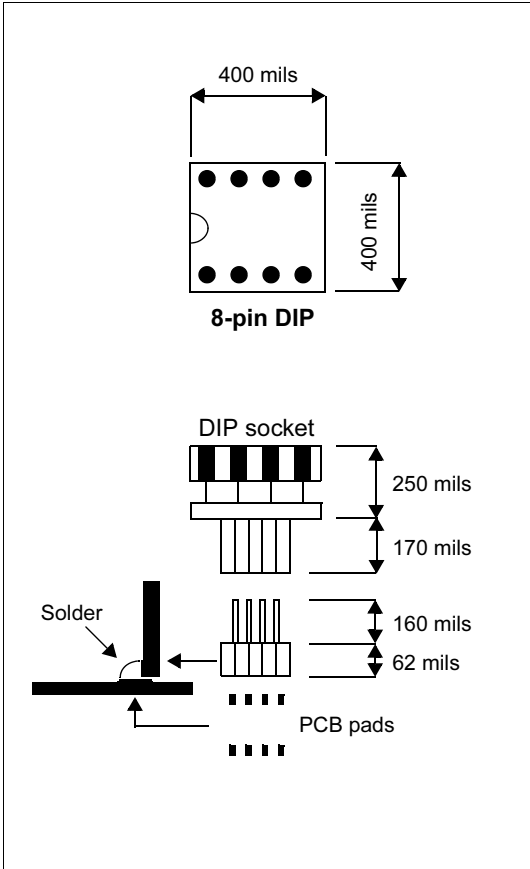

Transition Sockets

XLT28QFN

28-lead DIP to 0.600-inch Adapter Socket

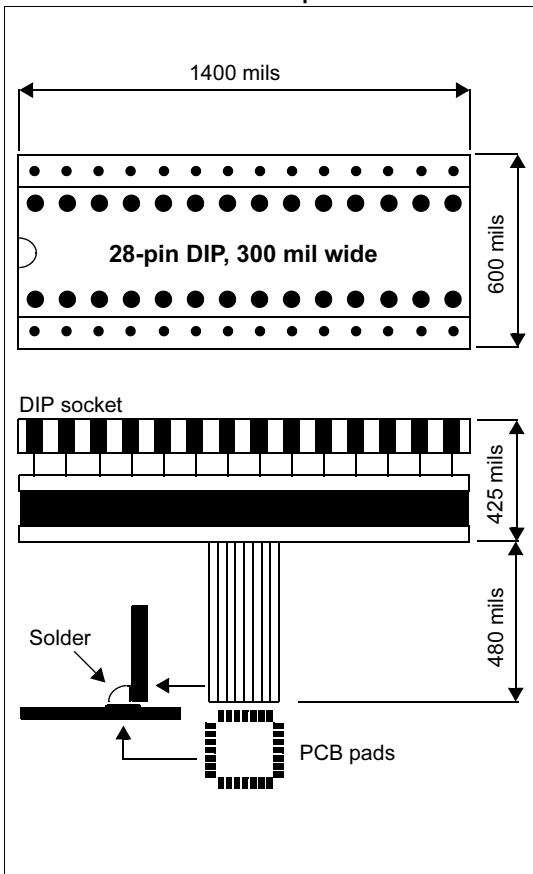

XLT28QFN2

18-lead DIP to 0.600-inch Adapter Socket

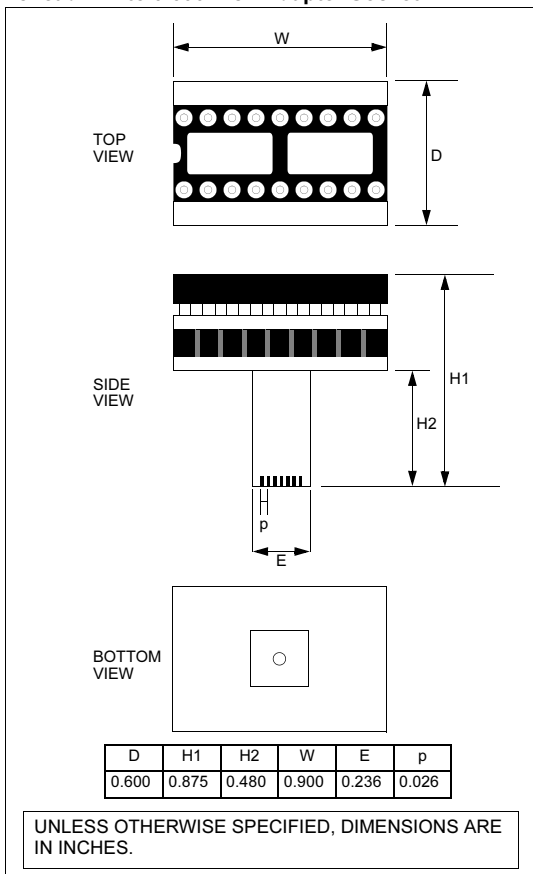

Transition Sockets

XLT44QFN

40-lead DIP to 0.600-inch Adapter Socket

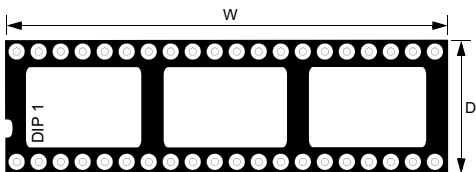

TOP
VIEW

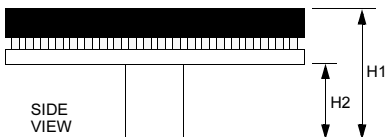

SIDE
VIEW

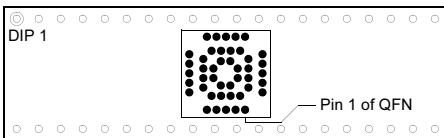

BOTTOM
VIEW

D	H1	H2	W
0.695	0.730	0.50	2.058

UNLESS OTHERWISE SPECIFIED, DIMENSIONS ARE
IN INCHES.

44-lead QFN Header

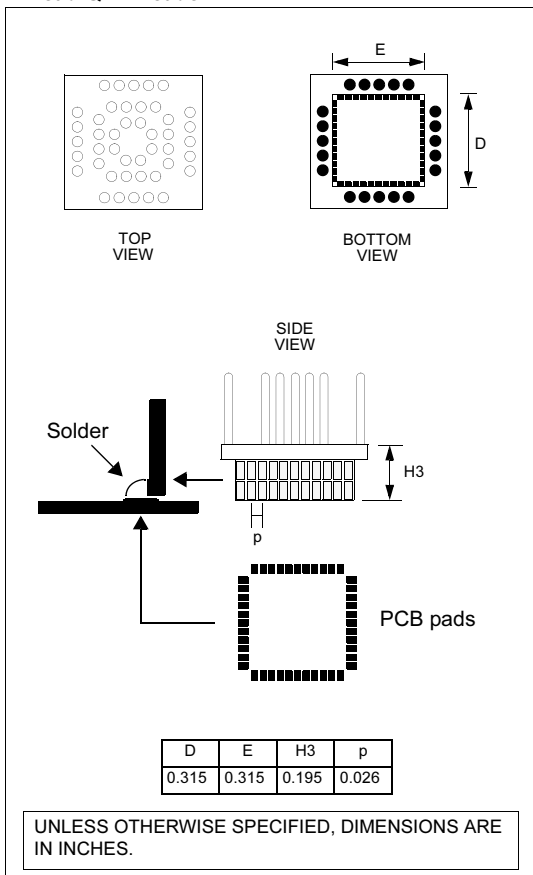

Information contained in this publication regarding device applications and the like is intended through suggestion only and may be superseded by updates. It is your responsibility to ensure that your application meets with your specifications. No representation or warranty is given and no liability is assumed by Microchip Technology Incorporated with respect to the accuracy or use of such information, or infringement of patents or other intellectual property rights arising from such use or otherwise. Use of Microchip's products as critical components in life support systems is not authorized except with express written approval by Microchip. No licenses are conveyed, implicitly or otherwise, under any intellectual property rights.

The graphics in this document are for illustration only. Microchip reserves the right to modify the contents of its development systems.

Trademarks

The Microchip name and logo, the Microchip logo, Accuron, dsPIC, KEELOQ, MPLAB, PIC, PICmicro, PICSTART, PRO MATE and PowerSmart are registered trademarks of Microchip Technology Incorporated in the U.S.A. and other countries.

AmpLab, FilterLab, microID, MXDEV, MXLAB, PICMASTER, SEEVAL and The Embedded Control Solutions Company are registered trademarks of Microchip Technology Incorporated in the U.S.A.

Application Maestro, dsPICDEM, dsPICDEM.net, ECAN, ECONOMONITOR, FanSense, FlexROM, fuzzyLAB, In-Circuit Serial Programming, ICSP, ICEPIC, microPort, Migratable Memory, MPASM, MPLIB, MPLINK, MPSIM, PICkit, PICDEM, PICDEM.net, PowerCal, PowerInfo, PowerMate, PowerTool, rLAB, rPIC, Select Mode, SmartSensor, SmartShunt, SmartTel and Total Endurance are trademarks of Microchip Technology Incorporated in the U.S.A. and other countries.

Serialized Quick Turn Programming (SQTP) is a service mark of Microchip Technology Incorporated in the U.S.A.

All other trademarks mentioned herein are property of their respective companies.

© 2003, Microchip Technology Incorporated, Printed in the U.S.A., All Rights Reserved.



Printed on recycled paper.

Worldwide Sales and Service

AMERICAS

Corporate Office

Tel: 480-792-7200

Technical Support:
480-792-7627

Atlanta

Tel: 770-640-0034

Boston

Tel: 978-692-3848

Chicago

Tel: 630-285-0071

Dallas

Tel: 972-818-7423

Detroit

Tel: 248-538-2250

Kokomo

Tel: 765-864-8360

Los Angeles

Tel: 949-263-1888

Phoenix

Tel: 480-792-7966

San Jose

Tel: 408-436-7950

Toronto

Tel: 905-673-0699

ASIA/PACIFIC

Australia

Tel: 61-2-9868-6733

China - Beijing

Tel: 86-10-85282100

China - Chengdu

Tel: 86-28-86766200

China - Fuzhou

Tel: 86-591-7503506

China - Hong

Kong SAR

Tel: 852-2401-1200

China - Shanghai

Tel: 86-21-6275-5700

China - Shenzhen

Tel: 86-755-82901380

China - Shunde

Tel: 86-765-8395507

China - Qingdao

Tel: 86-532-5027355

India

Tel: 91-80-2290061

Japan

Tel: 81-45-471- 6166

Korea

Tel: 82-2-554-7200

Singapore

Tel: 65-6334-8870

Taiwan -

Kaohsiung

Tel: 886-7-536-4818

Taiwan

Tel: 886-2-2717-7175

EUROPE

Austria

Tel: 43-7242-2244-399

Denmark

Tel: 45-4420-9895

France

Tel: 33-1-69-53-63-20

Germany

Tel: 49-89-627-144-0

Italy

Tel: 39-0331-742611

Netherlands

Tel: 31-416-690399

United Kingdom

Tel: 44-118-921-5869

07/28/03



Microchip received QS-9000 quality system certification for its worldwide headquarters, design and wafer fabrication facilities in Chandler and Tempe, Arizona in July 1999 and Mountain View, California in March 2002. The Company's quality system processes and procedures are QS-9000 compliant for its PICmicro[®] 8-bit MCUs, KEELoC[®] code hopping devices, Serial EEPROMs, microperipherals, non-volatile memory and analog products. In addition, Microchip's quality system for the design and manufacture of development systems is ISO 9001 certified.

