



- **Features**
- Input voltage: 90-305VAC
 - Built-in active PFC function: 0.99 Typ.
 - Low THD: 10% Typ.
 - High efficiency: 91% Typ.
 - IP67 design for indoor or outdoor installations
 - High surge immunity
 - Support Time-shared dimming function
 - Compliance to worldwide safety regulations for lighting
 - Suitable for dry/damp locations



■ **Specification**

Model		035	045	053	070	085	105	120	140	175	210	245	280	300	315	350	420	
(MU100HXXXAQ_CLKS)																		
Input	Efficiency(120Vac)(Typ.) ^{Note.1}	89%	89%	89%	89%	88%	88%	88%	88%	88%	87%	87%	87%	86%	86%	86%	86%	
	Efficiency(230Vac)(Typ.) ^{Note.1}	91%	91%	91%	91%	90%	90%	90%	90%	90%	89%	89%	89%	88%	88%	88%	88%	
	Voltage Range (V) ^{Note.2}	90 ~ 305Vac, OR 127~ 430Vdc (Derating may be need under low inputs, Refer to 'Derating Curve')																
	Voltage Rate (V) ^{Note.2}	100Vac-277Vac																
	Frequency Range (Hz)	47~63																
	Power Factor(Typ.)	0.99 (Typ.) with 80%~100% load,at 120Vac																
		0.96 (Typ.) with 80%~100% load,at 230Vac																
		>0.9 with 80%~100% load,at 277Vac																
	THD(Typ.)	<15% (typical), at 100~277Vac input, with 80%~100% load conditions																
		<10% (typical), at 220Vac/50Hz input, with 80%~100% load conditions																
AC Current(Typ.)	1.2A at 100VAC input, 0.6A at 230VAC																	
Inrush Current(Max.)	A at 230Vac input 25°C Cold Start (time wide=500uS, measured at 50% Ipeak,Not applicable for the inrush current to Noise Filter for less than 0.2m																	
Leakage Current(Max.)	1mA at 277Vac/60Hz																	
Output	Voltage range (V)	143~286	111~222	94~188	71~143	59~118	48~95	42~83	36~71	27~55	23~46	19~39	17~34	17~33	15~30.5	13~27	12~23	
	Rated Current(mA)	350	450	530	700	850	1050	1200	1400	1750	2100	2450	2800	3000	3150	3500	4200	
	Rated Power (W)	100	100	100	100	100	100	100	100	96	96	96	96	100	96	96	96	
	Ripple&Noise Current(Typ.)	≤30%((PK-AV) /AV) with LED default mode and full load)																
	Current Tolerance	±5%																
	Line Regulation	±1%																
	Load Regulation	±3%																
	Current ADJ. Range	-																
	Turn on delay Time	<1.2s, at 120Vac; <0.6s, at 277Vac																
Protection	Over Voltage(V)	373	289	230	186	143	124	103	92	72	60	51	44	43	40	35	30	
		Protection type: Voltage limiting,output will not exceed the upper limit voltage , recovers automatically after fault condition is removed.																
	Over Current	Protection type: Constant current limiting.																
	Short Circuit	Protection type: Hiccup mode. recovers automatically after short is removed.																
Over temperature	When the Tc of PSU rise to 90~110°C,Decreases output current,returning to normal after over temperature is removed.																	
Environment	Operating Temp.	-40~+70°C(Refer to 'Derating Curve')																
	Tc	90°C max																
	Operating Humidity	10~100%RH																
	Storage Temp., Humidity	-40~+80°C , 5-100%RH																
	Temp. Coefficient	0.03%/°C (0~50°C)																
Vibration	10-500Hz,5G 12min/cycle , period for 72min each along X、 Y、 Z axes																	
Safety & EMC	Safety Standard	UL8750, UL1012, UL1310 Class 2,CSA-C22.2 No. 107.1, CSA C22.2 NO. 223-M91 Class 2,EN61347-1, EN61347-2-13																
	Withstand Voltage	I/P-O/P:3.75KVac I/P-FG:1.875KV O/P-FG:1.5KV																
	Isolation Resistance	I/P-O/P, I/P-FG, O/P-FG:100M Ohms/500Vdc/25°C/70%RH																
	EMC Emission	EN55015/FCC Part 15 , EN61000-3-2 Class C, EN61000-3-3																
	EMC Immunity	EN61000-4-2,3,4,5,6,8,11 (Surge L,N-FG 6KV, L-N 4KV) , EN61547																
Others	MTBF	300,000 Hours,measured at full load,25°C ambient temperature																
	Lifetime	50,000 Hours at Tc 75°C(Refer to"Life Time VS. Tcase (Ref.)")																
	Dimension	187 x 67.5 x 40 (mm) (LxWxH)																
	Weight	0.85kg																

Note.1: Measured at full load and steady-state temperature in 25°C ambient(Efficiency will be about 2% lower if measured immediately after startup); Note. 2: Derating may be needed under low input voltages , Please Refer to 'Derating Curve' ; Note. 3: All parameters NOT specially mentioned are measured at 230VAC input , rated load and 25°C of ambient temperature ;

Derating Curve

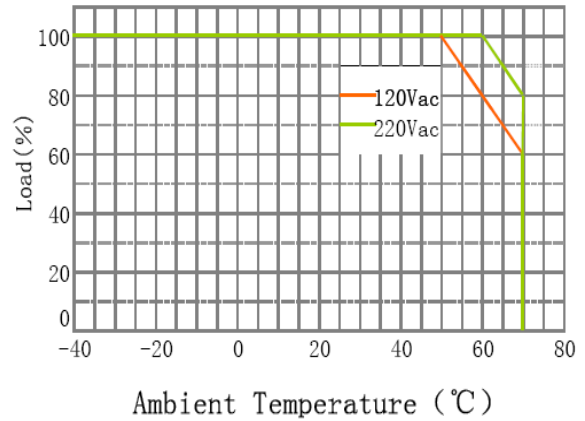
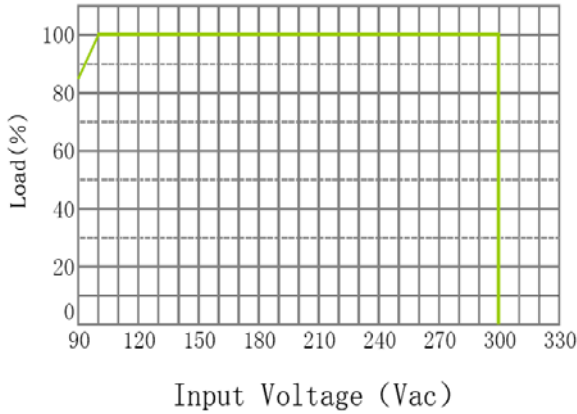

Power Factor VS. Load Curve

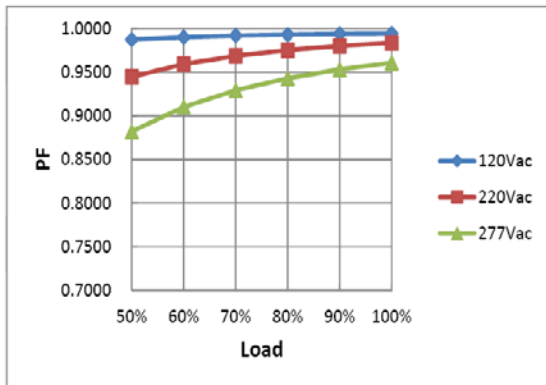

Efficiency VS. Load Curve

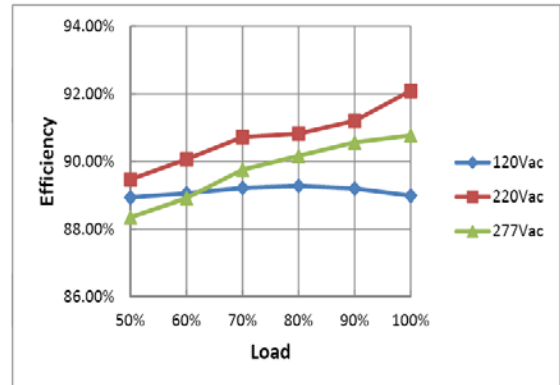

THD Curve

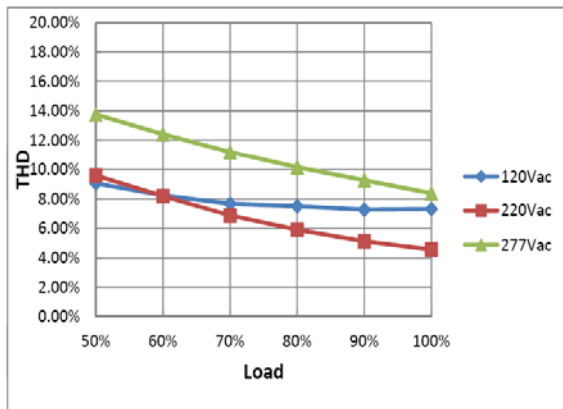

Life Time VS. Tcase (Ref.)

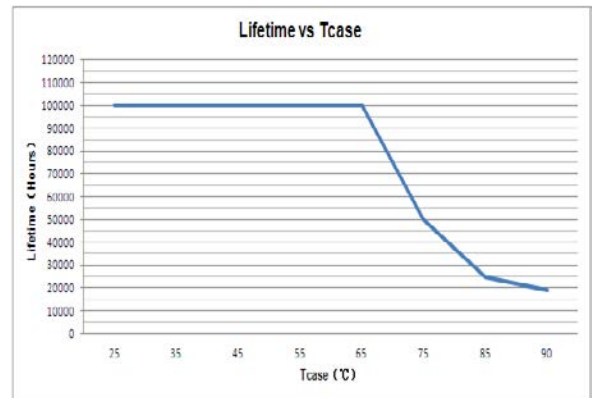

Instruction

1.Field Programmable Topology

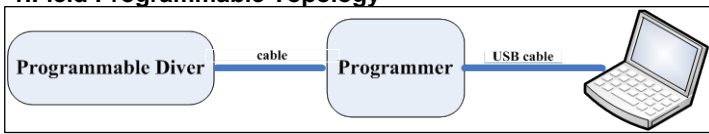

The programmable driver can be programmed by using special PC software and the programmer module.

2.Dimming Interface Description

Pin description

Pin	Name	Value	Description
1	Vaux 12V	10.8V-13.2V	Passive dimmers power supply
2	Dim+/Program	0-10V	Dimming/Programming input
3	Dim-	0V	DC Ground

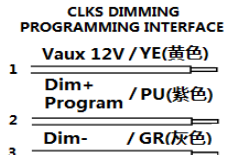

3.Dimming Software Function Instruction

Adjustable Output Current(AOC)

Adjustable Output Current(AOC)

Module Current mA

Max Current mA Power W

Users can set the rated current between 10%*Max Current and 100%*Max Current

PWM

Input a PWM signal from the 2nd pin(Dim+/Program) of the dimming interface to change the output current. User can set "Positive Logic" or "Negative Logic" of the PWM signal. PWM duty circle: 1%~99%(it has both positive and negative logics), frequency: 500Hz~5kHz, 3V~10V is

Adjustable Startup Time(AST)

Adjustable Startup Time(AST)

Start Fadeup Time s

Set driver's "Start Fade up Time". It means how much time the driver costs to achieve the "Module Current" that the user set. The valid value is 0s, 1s, 2s, 5s, 10s, 20s, 40s.

Dimming Interface Selection(DIS)

1-10V PWM Smart Midnight ClockDIM Fixed ClockDIM No Dimming

PWM Logic(PWML)

Positive Or Negative Logic

Fade Time(FT)

Fade Time(FT)

Fadeup Time s

Set driver's "Fade up Time". This function is available in the Smart Midnight ClockDIM and Fixed ClockDIM mode; It means how much time the driver costs to achieve another dimming level from previous dimming level. The valid value is 0s, 1s, 2s, 5s, 10s, 20s, 40s.

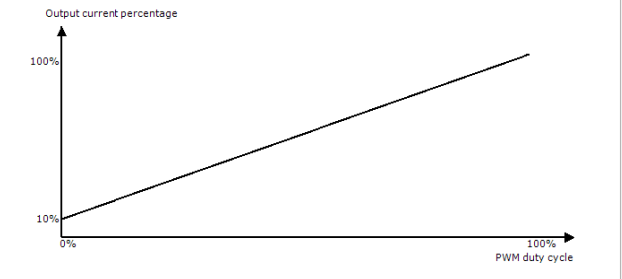

1-10V

Allow users to set the max and min output current and corresponding output voltage to clarify the 1-10V dimming curve. Input a 0~10V signal from 2nd pin of the dimming interface. Default: input ≤1V, output current 10%; input ≥

Dimming Interface Selection(DIS)

1-10V PWM Smart Midnight ClockDIM Fixed ClockDIM No Dimming

1-10V Min dim level V %

1-10V Max dim level V %

Instruction

Integrated Dynadimmer

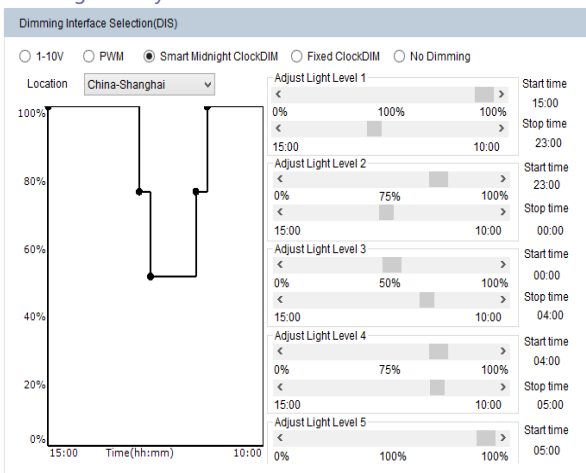

Integrated Dynadimmer allows dimming to predefined light levels based on the nightly operating time. With flexibility in setting time and light levels, the user can configure the driver for specific locations and application needs. Using Integrated Dynadimmer, it is possible to set up to 5 dim levels and time intervals. The driver does not have a real time clock. Instead it runs a virtual clock, determined by the length of nightly operating hours. After 3 ON-OFF cycles, the driver will calculate the virtual clock time. A valid ON-time is defined as a period during which the driver operates continuously for ≥ 4 hours to ≤ 24 hours. For example, if the requirement in summer is: 23:00-00:00: 75%, 00:00-04:00: 50%, 04:00-05:00: 75% (other time 100% or Off). The driver should be powered on for 7h, so it can calculate the virtual clock time as 22:00. Then we can set the dimming plan: 22:00-23:00: 100%, 23:00-00:00: 75%, 00:00-04:00: 50%, 04:00-05:00: 75%. From summer to winter, the valid ON-time changes day by day. The driver should be powered on for 17h in winter, and it also can calculate the virtual clock time as 17:00. Then the dimming plan is 17:00-23:00: 100%, 23:00-00:00: 75%, 00:00-04:00: 50%, 04:00-05:00: 75%, 05:00-10:00: 100%. From the above, if we set the dimming plan as shown in the picture, after repeating the driver ON-time for 3 consecutive days, the dimming plan takes effect from the 4th day onwards. Each day the driver powered on, it has a different start time according to the virtual clock

Constant Light Output(CLO)

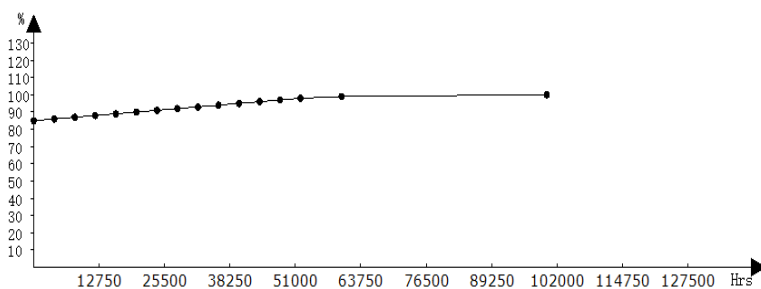
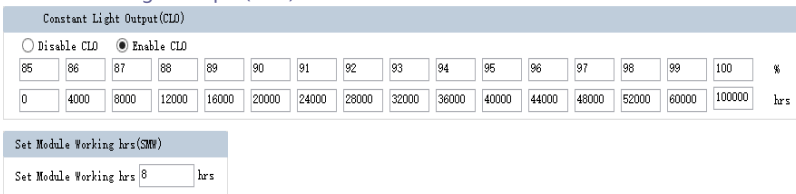

Integrated Dynadimmer Time Based

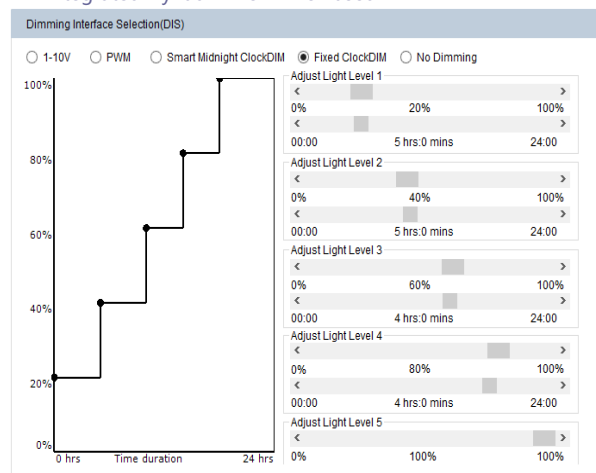

Allow users to separate 24hrs into 5 sections and corresponding output current.

No Dimming

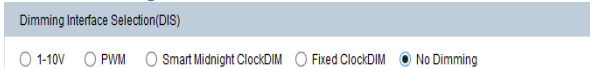

The driver will be in constant output mode.

Set MODULE Working hrs(SMW)

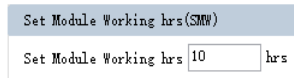

User can check how much time the driver works through this function.

Traditional light sources suffer from depreciation in light output over time. This applies to LED light sources as well. The CLO feature enables LED solutions to deliver constant lumen output through the life of the light engine. Based on the type of LEDs used, heat sinking and driver current, it is possible to estimate the depreciation of light output for specific LEDs and this information can be entered into the driver. The driver counts the number of light source working hours and will increase output current based on this input to enable CLO. When the CLO feature is enabled, the driver nominal output current will be defined by the CLO percentage as shown by the equation below: Driver target nominal output current = CLO percentage * AOC. For example, in the CLO profile shown in Figure, between 52,000-60,000 working hours, the CLO percentage is set at 98%. Assuming the nominal AOC is set to 500mA, the driver output current with CLO enabled will be $0.98 \times 500 = 600$ mA. The CLO percentage can be set to a value between 85%-100%, in increments of 1%. The LED module working hours can be set at any value between 0

■ Mechanical Specification

1. Dimensions (Unit: mm)

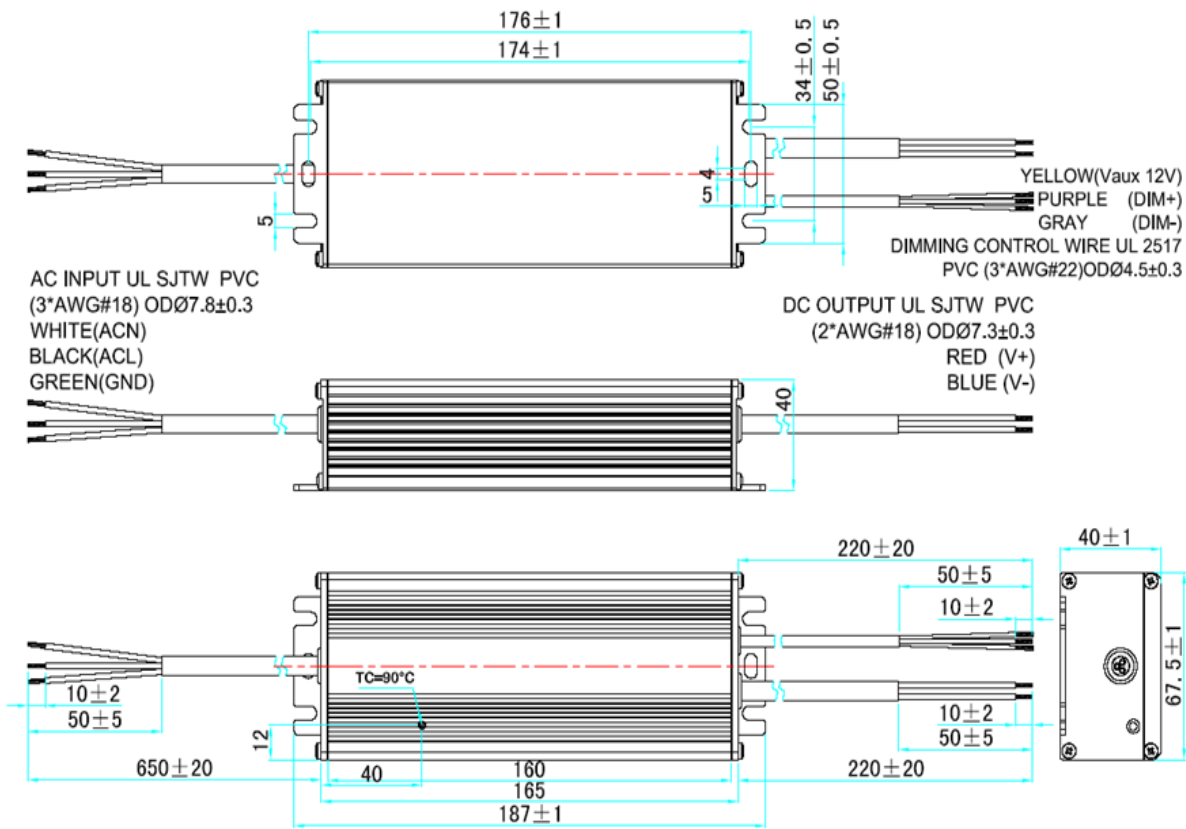

RoHS Compliance:

Our products comply with the European Directive 2002/95/EC, calling for the elimination of lead and other hazardous substances from electronic products.

2. Terminal wire Type

Products	AC Input			DC output			Dimming control		
	Wire Type	Assignment	Description	Wire Type	Assignment	Description	Wire Type	Assignment	Description
ENEC/CE approval for class II	RUBBER CCC+VDE 60245 IEC57 YZW/H05RN-F	BROWN/L	2*1.0mm ² ODΦ 6.8±0.3mm	RUBBER CCC+VDE 60245 IEC57 YZW/H05RN-F	Brown/+	2*1.0mm ² ODΦ 6.8±0.3mm	H05HRN-FODΦ 6.3±0.2mm or UL2517 PVCODΦ 4.5±0.3mm	BK/WH or YE/10V	3*0.5mm ² or 3*AWG#22
		BLUE/N			Blue/-			PU/DIM+	
UL approval	UL SJWTW PVC	BLACK/L	3*AWG#18	UL SJWTW PVC	RED/+	2*AWG#18		UL2517 PV CODΦ 4.5±0.3mm	
		WHITE/N			BLUE/-		PU/DIM+		
		GREEN/GN					GR/NEG		
PSE approval	PSE HVCTF/VCTF/VCTFK PVC	BLACK/L	3*0.75mm ² ODΦ 6.8±0.3mm	PSE HVCTF/VCTF/VCTFK PVC	WHITE/+	2*0.75mm ² ODΦ 6.7±0.3mm	UL2517 PVCODΦ 4.5±0.3mm	YE/10V	
		WHITE/N			BLACK/-			PU/DIM+	
		YE-GN/GND						GR/NEG	
CCC/CB/CE approval	RUBBER CCC+VDE 60245 IEC57 YZW/H05RN-F	BROWN/L	3*1.0mm ² ODΦ 7.3±0.3mm	RUBBER CCC+VDE 60245 IEC57 YZW/H05RN-F	Brown/+	2*1.0mm ² ODΦ 6.8±0.3mm	H05HRN-FODΦ 6.3±0.2mm or UL2517 PVCODΦ 4.5±0.3mm	BK/WH or YE/10V	
		BLUE/N			Blue/-			PU/DIM+	
		YE-GN/GND						GR/DIM-	

subject to change without notice

Page 5 of 5

SHANGHAI MOONS' AUTOMATION CONTROL CO., LTD.

Add: No.168, Mingjia Road, Shanghai 201107, P.R.China
Tel: +86 (0)21 52634688 Website: www.moons.com.cn