

IRS-B345ST03-R1

Specifications

Operating Temperature Range	-40°C to 70°C
Shape	SMD
Field of View	theta1=70deg.,theta2=50deg.
Electrode	(0.8x0.7mm)x4
Responsivity(typ.)	3.6mV
Optical Filter	3micro meter Long Pass
Supply Voltage Range	2V to 15V
Storage Temperature Range	-40°C to 85°C

Attention

- 1.This datasheet is downloaded from the website of Murata Manufacturing Co., Ltd. Therefore, it's specifications are subject to change or our products in it may be discontinued without advance notice. Please check with our sales representatives or product engineers before ordering.
- 2.This datasheet has only typical specifications because there is no space for detailed specifications.
Therefore, please review our product specifications or consult the approval sheet for product specifications before ordering.

IRS-B345ST03-R1

Product Data

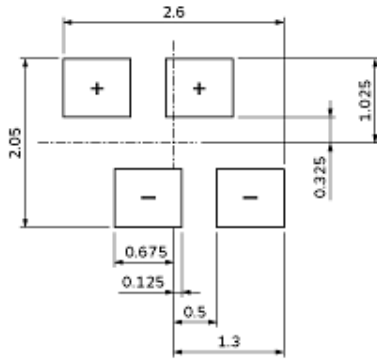

(in mm)

Pyroelectric Element

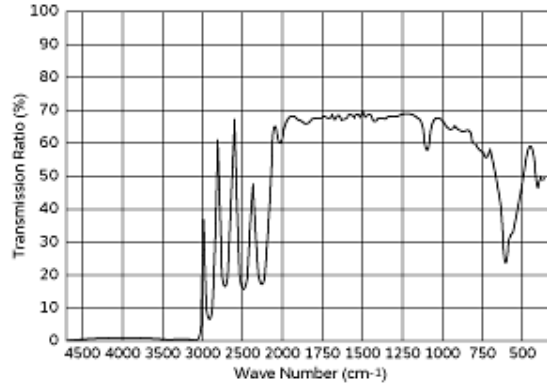

Filter characteristics

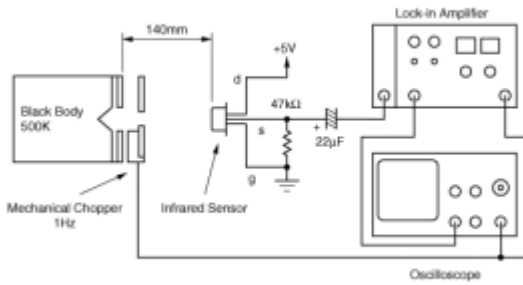

Test circuit

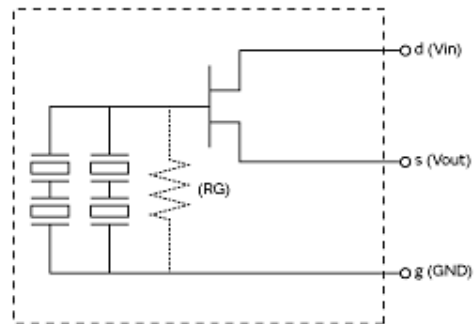

Circuit diagrams

Attention

1.This datasheet is downloaded from the website of Murata Manufacturing Co., Ltd. Therefore, it's specifications are subject to change or our products in it may be discontinued without advance notice. Please check with our sales representatives or product engineers before ordering.
2.This datasheet has only typical specifications because there is no space for detailed specifications.
Therefore, please review our product specifications or consult the approval sheet for product specifications before ordering.