

D2FW-G

M4 Mounting Sealed Basic Switch

Easy to mount with one single screw. A sealed switch ideal for use in adverse environment conditions

- Single-point mounting with an M4 screw.
- Incorporates a fixed leaf lever for tough environments.
- Molded lead wires are installed using lead-free connections for environmental conservation.

RoHS Compliant

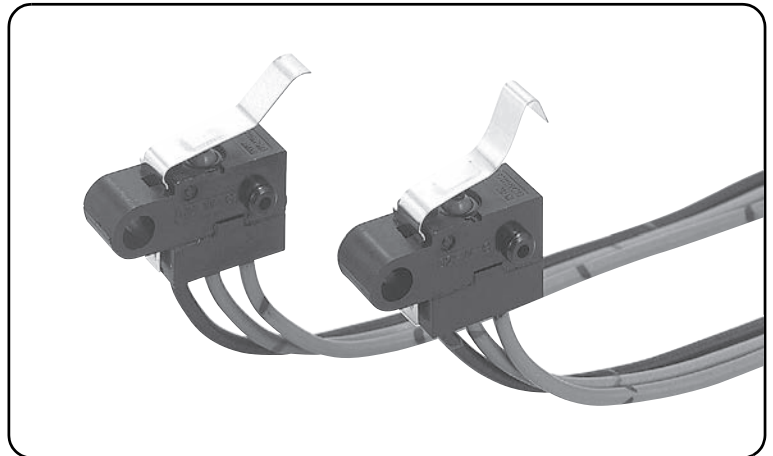

D2FW-G

Model Number Legend

D2FW-G 1 2 3 M

1. Ratings

- 2 : 30 VDC 1A
- 0 : 30 VDC 0.1A



2. Levers

- 7 : Leaf lever
- 8 : Long leaf lever

3. Contact form

- 1 : SPDT
- 2 : SPST-NC
- 3 : SPST-NO

List of Models

Actuator	Ratings	Contact form	1 A	0.1 A
Leaf lever 		SPDT	D2FW-G271M	D2FW-G071M
		SPST-NC	D2FW-G272M	D2FW-G072M
		SPST-NO	D2FW-G273M	D2FW-G073M
Long leaf lever 		SPDT	D2FW-G281M	D2FW-G081M
		SPST-NC	D2FW-G282M	D2FW-G082M
		SPST-NO	D2FW-G283M	D2FW-G083M

Contact form

● SPDT

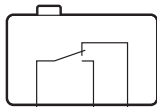

COM (Black) NO (Blue) NC (Red)

● SPST-NC

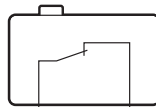

COM (Black) NC (Red)

● SPST-NO

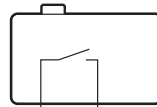

COM (Black) NO (Blue)

The color in parentheses indicates the color of the lead wire.

Contact Specifications

Item	Model	D2FW-G2 models	D2FW-G0 models
Contact	Specification	Crossbar	
	Material	Silver alloy	Gold alloy
	Gap (standard value)	0.25 mm	
Minimum applicable load (reference value) *		5 VDC 100 mA	5 VDC 1 mA

* Please refer to "●Using Micro Loads" in "Precautions" for more information on the minimum applicable load.

Ratings

Model	D2FW-G2 models	D2FW-G0 models
Rated voltage	Resistive load	
30 VDC	1 A	0.1 A

Note. The above rating values apply under the following test conditions.

- (1) Ambient temperature: 20±2°C
- (2) Ambient humidity: 65±5%
- (3) Operating frequency: 20 operations/min

Characteristics

Item	Model	D2FW-G2 models	D2FW-G0 models
Permissible operating speed		1mm to 500mm/s	
Permissible operating frequency	Mechanical	120 operations/min	
	Electrical	30 operations/min	
Insulation resistance		100 MΩ min. (at 500 VDC with insulation tester)	
Contact resistance (initial value)		100 mΩ max.	150 mΩ max.
Dielectric strength	Between terminals of the same polarity	600 VAC 50/60 Hz for 1 min	
	Between current-carrying metal parts and ground	1,500 VAC 50/60 Hz for 1 min	
	Between each terminal and non-current-carrying metal parts	1,500 VAC 50/60 Hz for 1 min	
Vibration resistance * 1	Malfunction	10 to 55 Hz, 1.5 mm double amplitude	
Shock resistance	Durability	1,000 m/s ² {approx. 100G} max.	
	Malfunction * 1	300 m/s ² {approx. 30G} max.	
Durability * 2	Mechanical	300,000 operations min. (60 operations/min)	
	Electrical	30,000 operations min. (20 operations/min)	100,000 operations min. (20 operations/min)
Degree of protection		IEC IP67	
Ambient operating temperature		-40°C to +85°C (at ambient humidity 60% max.) (with no icing or condensation)	
Ambient operating humidity		95% max. (for +5°C to +35°C)	
Weight		Approx. 10.4 g (for SPDT model)	

Note. The data given above are initial values.

*1. The values are at Free Position and Total Travel Position values for pin plunger, and Total Travel Position value for lever. Close or open circuit of the contact is 1ms max.

*2. For testing conditions, consult your OMRON sales representative.

Mounting Holes (Unit: mm)

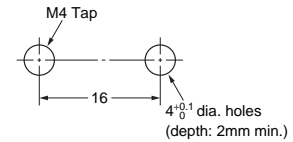

D2FW-G

Dimensions (Unit: mm)/Operating Characteristics

The □ is replaced with the code for the ratings and the contact forms. See the "List of Models" for available combinations of shapes.

● Leaf lever

D2FW-G□7□M

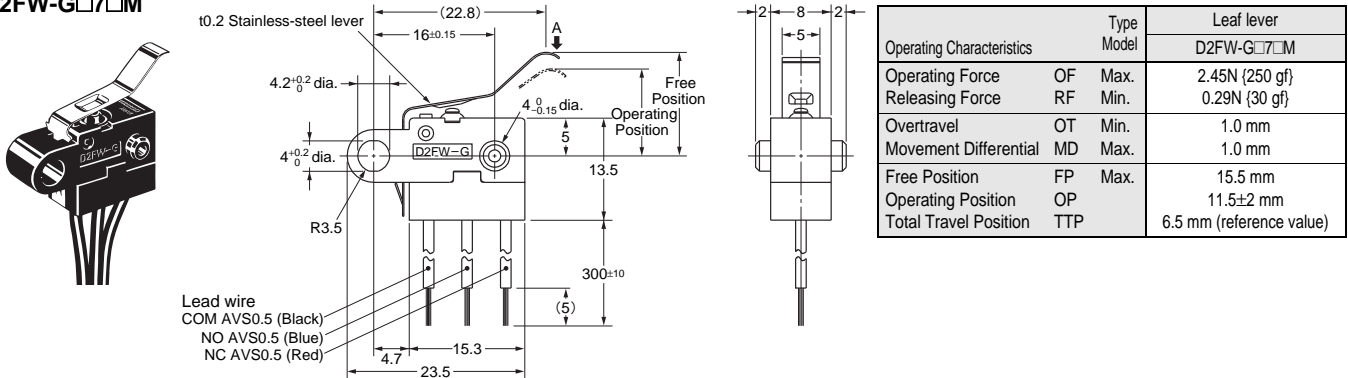

● Long leaf lever

D2FW-G□8□M

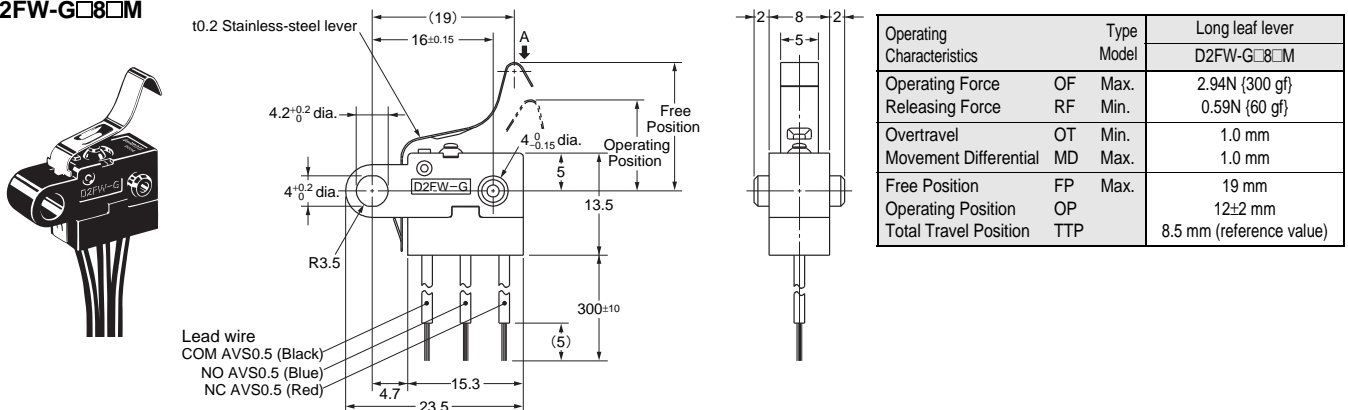

Note1. Unless otherwise specified, a tolerance of ±0.4 mm applies to all dimensions.

Note2. The operating characteristics are for operation in the A direction (↓).

Precautions

★Please refer to "Basic Switches Common Precautions" for correct use.

Cautions

Use the Switch within the specified Voltage rating. Using the Switch outside of the rated values will not only shorten its durability but may cause heat generation or fire damage. When turning the power ON or OFF, use the rated voltage and current.

●Degree of Protection

Do not use the Switch underwater.

The Switch was tested and found to meet the conditions necessary to meet the following standards. The test checks for water intrusion after immersion for a specified time period, not for switching operation underwater.

JIS C0920:

Degrees of protection provided by enclosures of electrical apparatus (IP Code)

IEC 60529:

Degrees of protection provided by enclosures (IP Code)

Degree of protection: IP67

(check water intrusion after immersion for 30 min. submerged 1m underwater)

●Protection Against Chemicals

Prevent the Switch from coming into contact with oil or chemicals.

Otherwise, damage to or deterioration of Switch materials may result.

Correct Use

●Mounting

- Turn OFF the power supply before mounting or removing the Switch, wiring, or performing maintenance or inspection. Failure to do so may result in electric shock or burning.
- Use M4 mounting screws with plane washers or spring washers to securely mount the Switch. Tighten the screws to a torque of 1.18 to 1.47N·m {12 to 15 kgf·cm}.

●Switch Mounting

When mounting the Switch, do not apply force to the actuator in any direction other than its operating direction.

●Operation

Make sure that the switching object is perfectly separated from the actuator when it is at the free position and the actuator is pressed appropriately by the switching object when the switch is operated.

The switching object must not move beyond its total travel position, otherwise the Switch may be damaged.

Install the switching object so that its moving direction is the same as that of the actuator.

●Using Micro Loads

- Even when using micro load models within the operating range shown below, if inrush/surge current occurs, it may increase the contact wear and so decrease durability. Therefore, insert a contact protection circuit where necessary.
- The minimum applicable load is the N-level reference value. This value indicates the malfunction reference level for the reliability level of 60% (λ_{60}). (JIS C5003)

The equation, $\lambda_{60}=0.5 \times 10^{-6} / \text{operations}$, indicates that the estimated malfunction rate is less than $\frac{1}{2,000,000}$ operations with a reliability level of 60%.

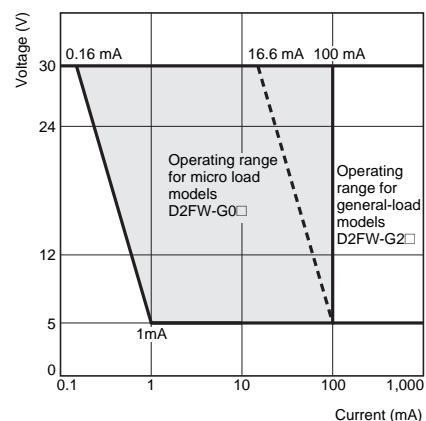

• Application examples provided in this document are for reference only. In actual applications, confirm equipment functions and safety before using the product.
• Consult your OMRON representative before using the product under conditions which are not described in the manual or applying the product to nuclear control systems, railroad systems, aviation systems, vehicles, combustion systems, medical equipment, amusement machines, safety equipment, and other systems or equipment that may have a serious influence on lives and property if used improperly. Make sure that the ratings and performance characteristics of the product provide a margin of safety for the system or equipment, and be sure to provide the system or equipment with double safety mechanisms.

Note: Do not use this document to operate the Unit.

OMRON Corporation

ELECTRONIC AND MECHANICAL COMPONENTS COMPANY

Contact: www.omron.com/ecb

Cat. No. B104-E1-03
0812(0207)(O)