

# 1PMT5920B Series

## 3.2 Watt Plastic Surface Mount POWERMITE® Package

This complete new line of 3.2 Watt Zener Diodes are offered in highly efficient micro miniature, space saving surface mount with its unique heat sink design. The POWERMITE package has the same thermal performance as the SMA while being 50% smaller in footprint area and delivering one of the lowest height profiles (1.1 mm) in the industry. Because of its small size, it is ideal for use in cellular phones, portable devices, business machines and many other industrial/consumer applications.

### Specification Features:

- Zener Breakdown Voltage: 6.2 – 47 Volts
- DC Power Dissipation: 3.2 Watts with Tab 1 (Cathode) @ 75°C
- Low Leakage < 5  $\mu$ A
- ESD Rating of Class 3 (> 16 kV) per Human Body Model
- Low Profile – Maximum Height of 1.1 mm
- Integral Heat Sink/Locking Tabs
- Full Metallic Bottom Eliminates Flux Entrapment
- Small Footprint – Footprint Area of 8.45 mm<sup>2</sup>
- Supplied in 12 mm Tape and Reel
  - T1 = 3,000 Units per Reel
  - T3 = 12,000 Units per Reel
- POWERMITE is JEDEC Registered as DO-216AA
- Cathode Indicated by Polarity Band

### Mechanical Characteristics:

**CASE:** Void-free, transfer-molded, thermosetting plastic

**FINISH:** All external surfaces are corrosion resistant and leads are readily solderable

**MOUNTING POSITION:** Any

**MAXIMUM CASE TEMPERATURE FOR SOLDERING PURPOSES:**  
260°C for 10 Seconds



ON Semiconductor®

<http://onsemi.com>

## PLASTIC SURFACE MOUNT 3.2 WATT ZENER DIODES 6.2 – 47 VOLTS

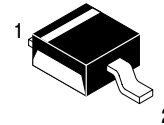
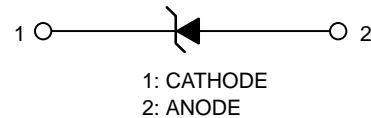

POWERMITE  
CASE 457  
PLASTIC

### MARKING DIAGRAM

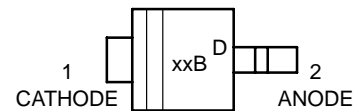

xxB = Specific Device Code  
xx = 20 – 41  
(See Table Next Page)  
D = Date Code

### ORDERING INFORMATION

Device	Package	Shipping
1PMT59xxBT1	POWERMITE	3,000/Tape & Reel
1PMT59xxBT3	POWERMITE	12,000/Tape & Reel

### LEAD ORIENTATION IN TAPE:

Cathode (Short) Lead to Sprocket Holes

# 1PMT5920B Series

## MAXIMUM RATINGS

Rating	Symbol	Value	Unit
DC Power Dissipation @ $T_A = 25^\circ\text{C}$ (Note 1) Derate above $25^\circ\text{C}$	$P_D$	500	mW
Thermal Resistance from Junction to Ambient	$R_{\theta JA}$	4.0	$\text{mW}/^\circ\text{C}$
Thermal Resistance from Junction to Lead (Anode)	$R_{\theta J\text{anode}}$	248	$^\circ\text{C}/\text{W}$
Thermal Resistance from Junction to Lead (Anode)	$R_{\theta J\text{anode}}$	35	$^\circ\text{C}/\text{W}$
Maximum DC Power Dissipation (Note 2) Thermal Resistance from Junction to Tab (Cathode)	$P_D$ $R_{\theta J\text{cathode}}$	3.2 23	W $^\circ\text{C}/\text{W}$
Operating and Storage Temperature Range	$T_J, T_{\text{stg}}$	-55 to +150	$^\circ\text{C}$

- Mounted with recommended minimum pad size, PC board FR-4.
- At Tab (Cathode) temperature,  $T_{\text{tab}} = 75^\circ\text{C}$

**ELECTRICAL CHARACTERISTICS** ( $T_L = 25^\circ\text{C}$  unless otherwise noted,  $V_F = 1.5\text{ V Max.}$  @  $I_F = 200\text{ mAdc}$  for all types)

Symbol	Parameter
$V_Z$	Reverse Zener Voltage @ $I_{ZT}$
$I_{ZT}$	Reverse Current
$Z_{ZT}$	Maximum Zener Impedance @ $I_{ZT}$
$I_{ZK}$	Reverse Current
$Z_{ZK}$	Maximum Zener Impedance @ $I_{ZK}$
$I_R$	Reverse Leakage Current @ $V_R$
$V_R$	Reverse Voltage
$I_F$	Forward Current
$V_F$	Forward Voltage @ $I_F$

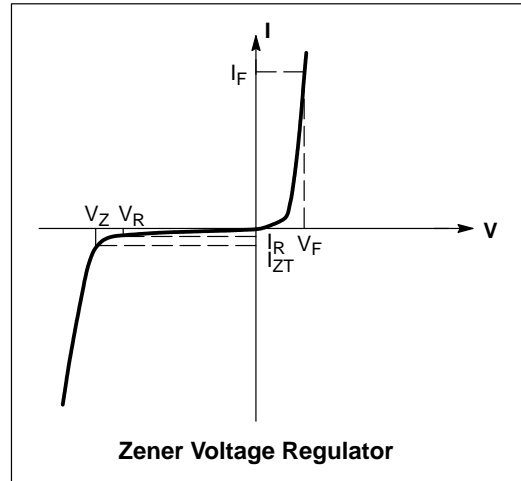

**ELECTRICAL CHARACTERISTICS** ( $T_L = 30^\circ\text{C}$  unless otherwise noted,  $V_F = 1.25\text{ Volts @ }200\text{ mA}$ )

Device	Device Marking	Zener Voltage (Note 3)			$I_{ZT}$ (mA)	$I_R @ V_R$ ( $\mu\text{A}$ )	$V_R$ (V)	$Z_{ZT} @ I_{ZT}$ (Note 4) ( $\Omega$ )	$Z_{ZK} @ I_{ZK}$ (Note 4) ( $\Omega$ )	$I_{ZK}$ (mA)
		$V_Z @ I_{ZT}$ (Volts)								
		Min	Nom	Max						
1PMT5920BT1, T3	20B	5.89	6.2	6.51	60.5	5.0	4.0	2.0	200	1.0
1PMT5921BT1, T3	21B	6.46	6.8	7.14	55.1	5.0	5.2	2.5	200	1.0
1PMT5922BT1, T3	22B	7.12	7.5	7.88	50	5.0	6.0	3.0	400	0.5
1PMT5923BT1, T3	23B	7.79	8.2	8.61	45.7	5.0	6.5	3.5	400	0.5
1PMT5924BT1, T3	24B	8.64	9.1	9.56	41.2	5.0	7.0	4.0	500	0.5
1PMT5925BT1, T3	25B	9.5	10	10.5	37.5	5.0	8.0	4.5	500	0.25
1PMT5927BT1, T3	27B	11.4	12	12.6	31.2	1.0	9.1	6.5	550	0.25
1PMT5929BT1, T3	29B	14.25	15	15.75	25	1.0	11.4	9.0	600	0.25
1PMT5930BT1, T3	30B	15.2	16	16.8	23.4	1.0	12.2	10	600	0.25
1PMT5931BT1, T3	31B	17.1	18	18.9	20.8	1.0	13.7	12	650	0.25
1PMT5933BT1, T3	33B	20.9	22	23.1	17	1.0	16.7	17.5	650	0.25
1PMT5934BT1, T3	34B	22.8	24	25.2	15.6	1.0	18.2	19	700	0.25
1PMT5935BT1, T3	35B	25.65	27	28.35	13.9	1.0	20.6	23	700	0.25
1PMT5936BT1, T3	36B	28.5	30	31.5	12.5	1.0	22.8	28	750	0.25
1PMT5939BT1, T3	39B	37.05	39	40.95	9.6	1.0	29.7	45	900	0.25
1PMT5941BT1, T3	41B	44.65	47	49.35	8.0	1.0	35.8	67	1000	0.25

- Zener voltage is measured with the device junction in thermal equilibrium with an ambient temperature of  $25^\circ\text{C}$ .
- Zener Impedance Derivation  $Z_{ZT}$  and  $Z_{ZK}$  are measured by dividing the AC voltage drop across the device by the AC current applied. The specified limits are for  $I_{Z(ac)} = 0.1 I_{Z(dc)}$  with the ac frequency = 60 Hz.

# 1PMT5920B Series

## TYPICAL CHARACTERISTICS

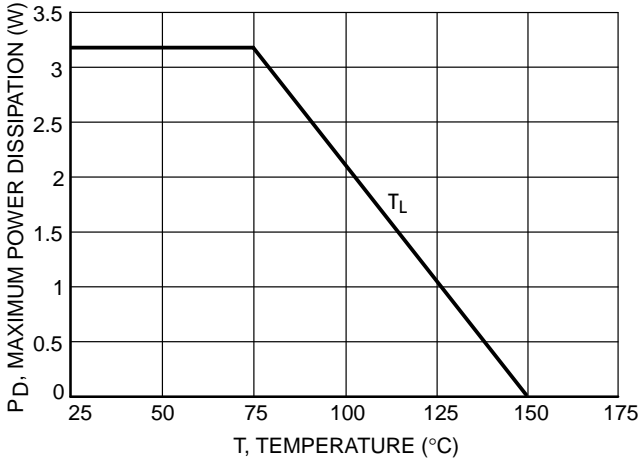

Figure 1. Steady State Power Derating

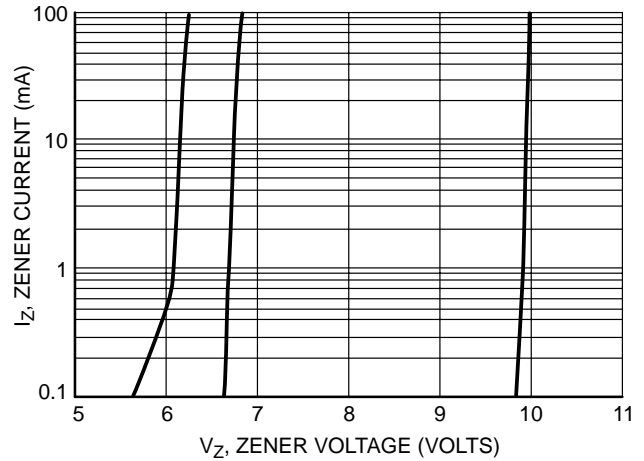

Figure 2.  $V_Z$  to 10 Volts

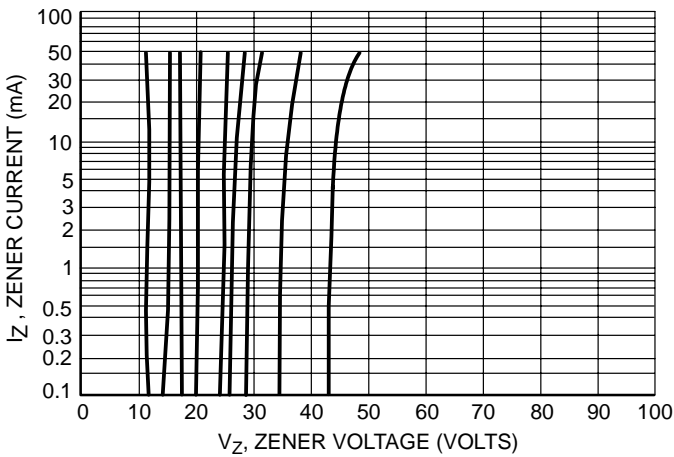

Figure 3.  $V_Z = 12$  thru 47 Volts

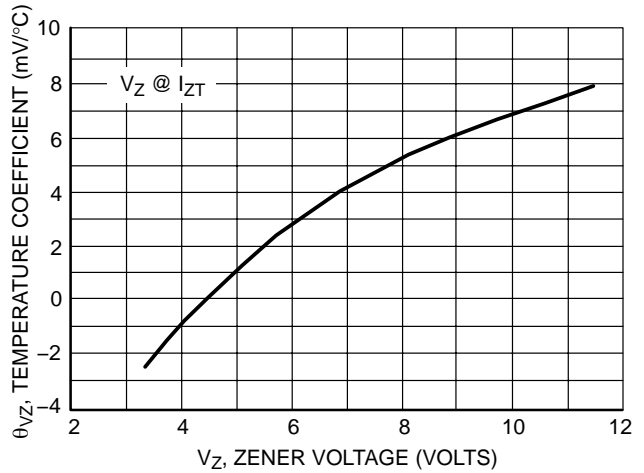

Figure 4. Zener Voltage - To 12 Volts

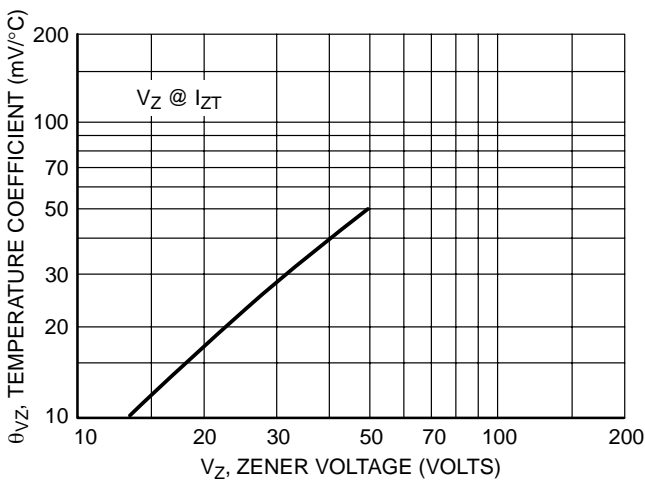

Figure 5. Zener Voltage - 14 To 47 Volts

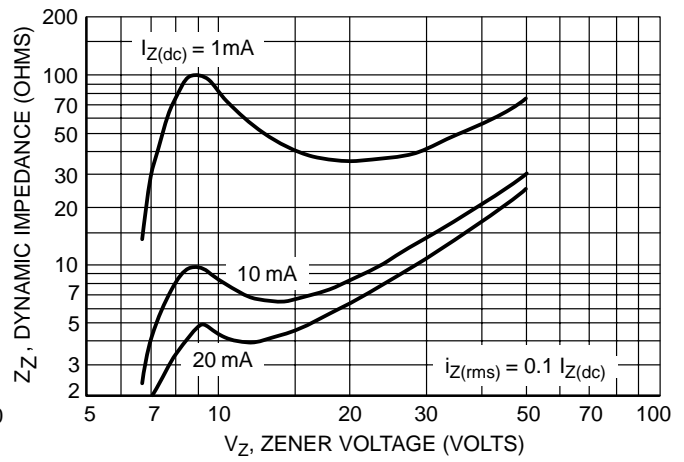

Figure 6. Effect of Zener Voltage

# 1PMT5920B Series

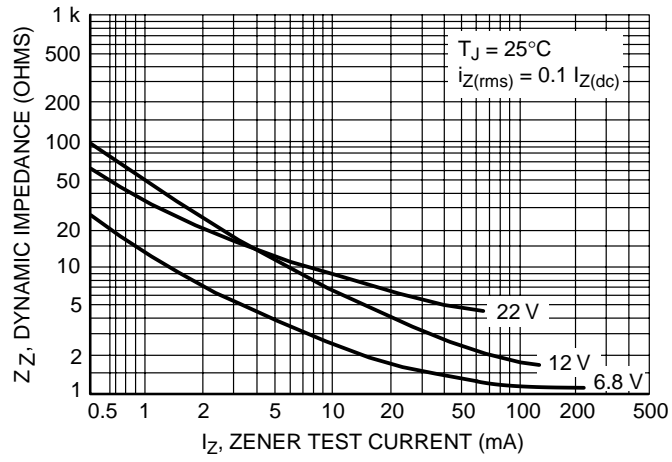

Figure 7. Effect of Zener Current

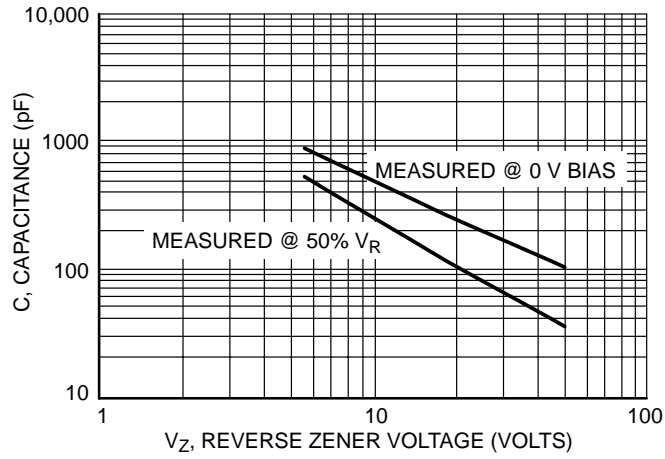

Figure 8. Capacitance versus Reverse Zener Voltage

TYPICAL SOLDER HEATING PROFILE

For any given circuit board, there will be a group of control settings that will give the desired heat pattern. The operator must set temperatures for several heating zones and a figure for belt speed. Taken together, these control settings make up a heating “profile” for that particular circuit board. On machines controlled by a computer, the computer remembers these profiles from one operating session to the next. Figure 9 shows a typical heating profile for use when soldering a surface mount device to a printed circuit board. This profile will vary among soldering systems, but it is a good starting point. Factors that can affect the profile include the type of soldering system in use, density and types of components on the board, type of solder used, and the type of board or substrate material being used. This profile shows temperature versus time.

The line on the graph shows the actual temperature that might be experienced on the surface of a test board at or near a central solder joint. The two profiles are based on a high density and a low density board. The Vitronics SMD310 convection/infrared reflow soldering system was used to generate this profile. The type of solder used was 62/36/2 Tin Lead Silver with a melting point between 177–189°C. When this type of furnace is used for solder reflow work, the circuit boards and solder joints tend to heat first. The components on the board are then heated by conduction. The circuit board, because it has a large surface area, absorbs the thermal energy more efficiently, then distributes this energy to the components. Because of this effect, the main body of a component may be up to 30 degrees cooler than the adjacent solder joints.

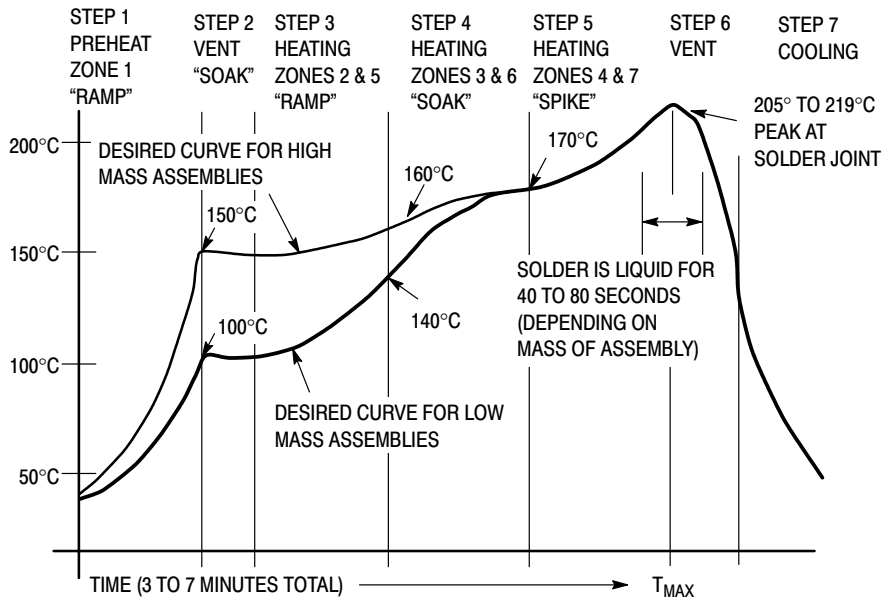

Figure 9. Typical Solder Heating Profile

INFORMATION FOR USING THE POWERMITE SURFACE MOUNT PACKAGE

MINIMUM RECOMMENDED FOOTPRINT FOR SURFACE MOUNTED APPLICATIONS

Surface mount board layout is a critical portion of the total design. The footprint for the semiconductor packages must be the correct size to insure proper solder connection

interface between the board and the package. With the correct pad geometry, the packages will self align when subjected to a solder reflow process.

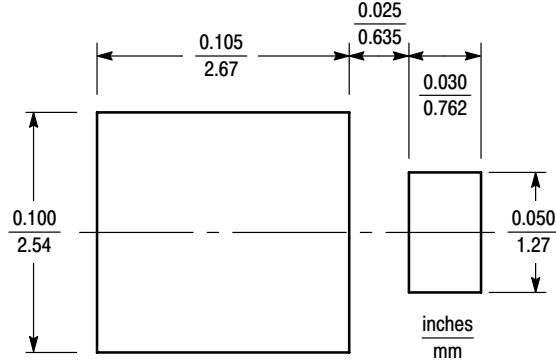

POWERMITE

POWERMITE POWER DISSIPATION

The power dissipation of the Powermite is a function of the drain pad size. This can vary from the minimum pad size for soldering to a pad size given for maximum power dissipation. Power dissipation for a surface mount device is determined by  $T_{J(max)}$ , the maximum rated junction temperature of the die,  $R_{\theta JA}$ , the thermal resistance from the device junction to ambient, and the operating temperature,  $T_A$ . Using the values provided on the data sheet for the Powermite package,  $P_D$  can be calculated as follows:

$$P_D = \frac{T_{J(max)} - T_A}{R_{\theta JA}}$$

The values for the equation are found in the maximum ratings table on the data sheet. Substituting these values into the equation for an ambient temperature  $T_A$  of 25°C, one can calculate the power dissipation of the device which in this case is 504 milliwatts.

$$P_D = \frac{150^\circ\text{C} - 25^\circ\text{C}}{248^\circ\text{C/W}} = 504 \text{ milliwatts}$$

The 248°C/W for the Powermite package assumes the use of the recommended footprint on a glass epoxy printed circuit board to achieve a power dissipation of 504 milliwatts. There are other alternatives to achieving higher power dissipation from the Powermite package. Another alternative would be to use a ceramic substrate or an aluminum core board such as Thermal Clad™. Using a board material such as Thermal Clad, an aluminum core board, the power dissipation can be doubled using the same footprint.

SOLDERING PRECAUTIONS

The melting temperature of solder is higher than the rated temperature of the device. When the entire device is heated to a high temperature, failure to complete soldering within a short time could result in device failure. Therefore, the following items should always be observed in order to minimize the thermal stress to which the devices are subjected.

- Always preheat the device.
- The delta temperature between the preheat and soldering should be 100°C or less.\*
- When preheating and soldering, the temperature of the leads and the case must not exceed the maximum temperature ratings as shown on the data sheet. When using infrared heating with the reflow soldering method, the difference shall be a maximum of 10°C.
- The soldering temperature and time shall not exceed 260°C for more than 10 seconds.
- When shifting from preheating to soldering, the maximum temperature gradient shall be 5°C or less.
- After soldering has been completed, the device should be allowed to cool naturally for at least three minutes. Gradual cooling should be used as the use of forced cooling will increase the temperature gradient and result in latent failure due to mechanical stress.
- Mechanical stress or shock should not be applied during cooling.

\* \* Soldering a device without preheating can cause excessive thermal shock and stress which can result in damage to the device.

# 1PMT5920B Series

## OUTLINE DIMENSIONS

# 1PMT5920BT3 Series – Surface Mounted

POWERMITE  
CASE 457-04  
ISSUE D

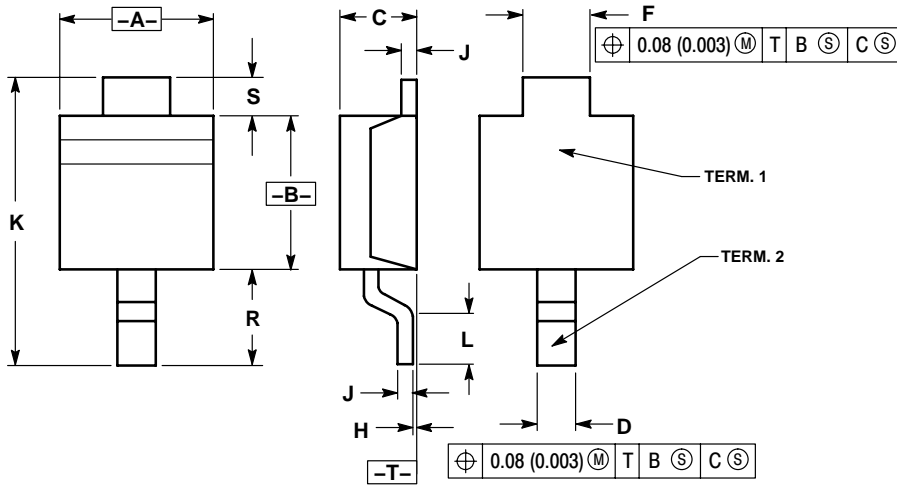

NOTES:

1. DIMENSIONING AND TOLERANCING PER ANSI Y14.5M, 1982.
2. CONTROLLING DIMENSION: MILLIMETER.
3. DIMENSION A DOES NOT INCLUDE MOLD FLASH, PROTRUSIONS OR GATE BURRS. MOLD FLASH, PROTRUSIONS OR GATE BURRS SHALL NOT EXCEED 0.15 (0.006) PER SIDE.

DIM	MILLIMETERS		INCHES	
	MIN	MAX	MIN	MAX
A	1.75	2.05	0.069	0.081
B	1.75	2.18	0.069	0.086
C	0.85	1.15	0.033	0.045
D	0.40	0.69	0.016	0.027
F	0.70	1.00	0.028	0.039
H	-0.05	+0.10	-0.002	+0.004
J	0.10	0.25	0.004	0.010
K	3.60	3.90	0.142	0.154
L	0.50	0.80	0.020	0.031
R	1.20	1.50	0.047	0.059
S	0.50	REF	0.019	REF

# 1PMT5920B Series

POWERMITE is a registered trademark of and used under a license from Microsemi Corporation.  
Thermal Clad is a trademark of the Bergquist Corporation.

**ON Semiconductor** and  are registered trademarks of Semiconductor Components Industries, LLC (SCILLC). SCILLC reserves the right to make changes without further notice to any products herein. SCILLC makes no warranty, representation or guarantee regarding the suitability of its products for any particular purpose, nor does SCILLC assume any liability arising out of the application or use of any product or circuit, and specifically disclaims any and all liability, including without limitation special, consequential or incidental damages. "Typical" parameters which may be provided in SCILLC data sheets and/or specifications can and do vary in different applications and actual performance may vary over time. All operating parameters, including "Typicals" must be validated for each customer application by customer's technical experts. SCILLC does not convey any license under its patent rights nor the rights of others. SCILLC products are not designed, intended, or authorized for use as components in systems intended for surgical implant into the body, or other applications intended to support or sustain life, or for any other application in which the failure of the SCILLC product could create a situation where personal injury or death may occur. Should Buyer purchase or use SCILLC products for any such unintended or unauthorized application, Buyer shall indemnify and hold SCILLC and its officers, employees, subsidiaries, affiliates, and distributors harmless against all claims, costs, damages, and expenses, and reasonable attorney fees arising out of, directly or indirectly, any claim of personal injury or death associated with such unintended or unauthorized use, even if such claim alleges that SCILLC was negligent regarding the design or manufacture of the part. SCILLC is an Equal Opportunity/Affirmative Action Employer.

## PUBLICATION ORDERING INFORMATION

### Literature Fulfillment:

Literature Distribution Center for ON Semiconductor  
P.O. Box 5163, Denver, Colorado 80217 USA  
**Phone:** 303-675-2175 or 800-344-3860 Toll Free USA/Canada  
**Fax:** 303-675-2176 or 800-344-3867 Toll Free USA/Canada  
**Email:** [orderlit@onsemi.com](mailto:orderlit@onsemi.com)

**N. American Technical Support:** 800-282-9855 Toll Free USA/Canada

**JAPAN:** ON Semiconductor, Japan Customer Focus Center  
2-9-1 Kamimeguro, Meguro-ku, Tokyo, Japan 153-0051  
**Phone:** 81-3-5773-3850

**ON Semiconductor Website:** <http://onsemi.com>

For additional information, please contact your local  
Sales Representative.