



Is Now Part of



**ON Semiconductor®**

To learn more about ON Semiconductor, please visit our website at  
[www.onsemi.com](http://www.onsemi.com)

ON Semiconductor and the ON Semiconductor logo are trademarks of Semiconductor Components Industries, LLC dba ON Semiconductor or its subsidiaries in the United States and/or other countries. ON Semiconductor owns the rights to a number of patents, trademarks, copyrights, trade secrets, and other intellectual property. A listing of ON Semiconductor's product/patent coverage may be accessed at [www.onsemi.com/site/pdf/Patent-Marking.pdf](http://www.onsemi.com/site/pdf/Patent-Marking.pdf). ON Semiconductor reserves the right to make changes without further notice to any products herein. ON Semiconductor makes no warranty, representation or guarantee regarding the suitability of its products for any particular purpose, nor does ON Semiconductor assume any liability arising out of the application or use of any product or circuit, and specifically disclaims any and all liability, including without limitation special, consequential or incidental damages. Buyer is responsible for its products and applications using ON Semiconductor products, including compliance with all laws, regulations and safety requirements or standards, regardless of any support or applications information provided by ON Semiconductor. "Typical" parameters which may be provided in ON Semiconductor data sheets and/or specifications can and do vary in different applications and actual performance may vary over time. All operating parameters, including "Typicals" must be validated for each customer application by customer's technical experts. ON Semiconductor does not convey any license under its patent rights nor the rights of others. ON Semiconductor products are not designed, intended, or authorized for use as a critical component in life support systems or any FDA Class 3 medical devices or medical devices with a same or similar classification in a foreign jurisdiction or any devices intended for implantation in the human body. Should Buyer purchase or use ON Semiconductor products for any such unintended or unauthorized application, Buyer shall indemnify and hold ON Semiconductor and its officers, employees, subsidiaries, affiliates, and distributors harmless against all claims, costs, damages, and expenses, and reasonable attorney fees arising out of, directly or indirectly, any claim of personal injury or death associated with such unintended or unauthorized use, even if such claim alleges that ON Semiconductor was negligent regarding the design or manufacture of the part. ON Semiconductor is an Equal Opportunity/Affirmative Action Employer. This literature is subject to all applicable copyright laws and is not for resale in any manner.

# BS170 / MMBF170 N-Channel Enhancement Mode Field Effect Transistor

## General Description

These N-Channel enhancement mode field effect transistors are produced using Fairchild's proprietary, high cell density, DMOS technology. These products have been designed to minimize on-state resistance while provide rugged, reliable, and fast switching performance. They can be used in most applications requiring up to 500mA DC. These products are particularly suited for low voltage, low current applications such as small servo motor control, power MOSFET gate drivers, and other switching applications.

## Features

- High density cell design for low  $R_{DS(ON)}$ .
- Voltage controlled small signal switch.
- Rugged and reliable.
- High saturation current capability.

### BS170

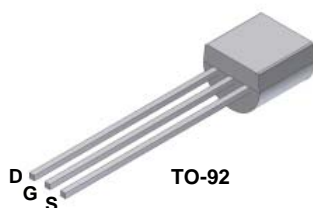

### MMBF170

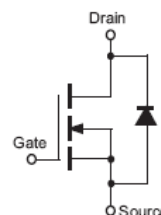
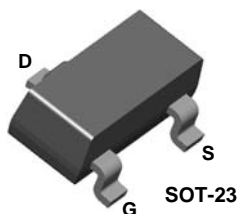

## Absolute Maximum Ratings $T_A = 25^\circ\text{C}$ unless otherwise noted

| Symbol         | Parameter   | BS170       | MMBF170 | Units            |
|----------------|---|-------------|---------|------------------|
| $V_{DSS}$      | Drain-Source Voltage  | 60          |         | V                |
| $V_{DGR}$      | Drain-Gate Voltage ( $R_{GS} \leq 1M\Omega$ )                                   | 60          |         | V                |
| $V_{GSS}$      | Gate-Source Voltage   | $\pm 20$    |         | V                |
| $I_D$          | Drain Current - Continuous<br>- Pulsed  | 500         | 500     | mA               |
|                |   | 1200        | 800     |                  |
| $T_J, T_{STG}$ | Operating and Storage Temperature Range   | - 55 to 150 |         | $^\circ\text{C}$ |
| $T_L$          | Maximum Lead Temperature for Soldering Purposes, 1/16" from Case for 10 Seconds | 300         |         | $^\circ\text{C}$ |

## Thermal Characteristics $T_A = 25^\circ\text{C}$ unless otherwise noted

| Symbol          | Parameter  | BS170 | MMBF170 | Units                     |
|-----------------|--|-------|---------|---------------------------|
| $P_D$           | Maximum Power Dissipation<br>Derate above $25^\circ\text{C}$ | 830   | 300     | mW                        |
|                 |  | 6.6   | 2.4     |                           |
| $R_{\theta JA}$ | Thermal Resistance, Junction to Ambient                      | 150   | 417     | $^\circ\text{C}/\text{W}$ |

**Electrical Characteristics**  $T_A=25^\circ\text{C}$  unless otherwise noted

| Symbol                                     | Parameter                         | Conditions  | Type    | Min. | Typ. | Max. | Units    |
|--|-----------------------------------|---|---------|------|------|------|----------|
| <b>OFF CHARACTERISTICS</b>                 |                                   |   |         |      |      |      |          |
| $BV_{DSS}$                                 | Drain-Source Breakdown Voltage    | $V_{GS} = 0V, I_D = 100\mu A$                                 | All     | 60   |      |      | V        |
| $I_{DSS}$                                  | Zero Gate Voltage Drain Current   | $V_{DS} = 25V, V_{GS} = 0V$                                   | All     |      |      | 0.5  | $\mu A$  |
| $I_{GSSF}$                                 | Gate - Body Leakage, Forward      | $V_{GS} = 15V, V_{DS} = 0V$                                   | All     |      |      | 10   | nA       |
| <b>ON CHARACTERISTICS (Notes 1)</b>        |                                   |   |         |      |      |      |          |
| $V_{GS(th)}$                               | Gate Threshold Voltage            | $V_{DS} = V_{GS}, I_D = 1mA$                                  | All     | 0.8  | 2.1  | 3    | V        |
| $R_{DS(on)}$                               | Static Drain-Source On-Resistance | $V_{GS} = 10V, I_D = 200mA$                                   | All     |      | 1.2  | 5    | $\Omega$ |
| $g_{FS}$                                   | Forward Transconductance          | $V_{DS} = 10V, I_D = 200mA$                                   | BS170   |      | 320  |      | mS       |
|  |                                   | $V_{DS} \geq 2 V_{DS(on)}, I_D = 200mA$                       | MMBF170 |      | 320  |      |          |
| <b>Dynamic Characteristics</b>             |                                   |   |         |      |      |      |          |
| $C_{iss}$                                  | Input Capacitance                 | $V_{DS} = 10V, V_{GS} = 0V, f = 1.0MHz$                       | All     |      | 24   | 40   | pF       |
| $C_{oss}$                                  | Output Capacitance                |   | All     |      | 17   | 30   | pF       |
| $C_{rss}$                                  | Reverse Transfer Capacitance      |   | All     |      | 7    | 10   | pF       |
| <b>Switching Characteristics (Notes 1)</b> |                                   |   |         |      |      |      |          |
| $t_{on}$                                   | Turn-On Time                      | $V_{DD} = 25V, I_D = 200mA, V_{GS} = 10V, R_{GEN} = 25\Omega$ | BS170   |      |      | 10   | ns       |
|  |                                   | $V_{DD} = 25V, I_D = 500mA, V_{GS} = 10V, R_{GEN} = 50\Omega$ | MMBF170 |      |      | 10   |          |
| $t_{off}$                                  | Turn-Off Time                     | $V_{DD} = 25V, I_D = 200mA, V_{GS} = 10V, R_{GEN} = 25\Omega$ | BS170   |      |      | 10   | ns       |
|  |                                   | $V_{DD} = 25V, I_D = 500mA, V_{GS} = 10V, R_{GEN} = 50\Omega$ | MMBF170 |      |      | 10   |          |

**Note:**

1. Pulse Test: Pulse Width  $\leq 300\mu s$ , Duty Cycle  $\leq 2.0\%$ .

**Ordering Information**

| Part Number | Package | Package Type  | Lead Frame | Pin array |
|-------------|---------|---------------|------------|-----------|
| BS170       | TO-92   | BULK          | STRAIGHT   | D G S     |
| BS170_D26Z  | TO-92   | Tape and Reel | FORMING    | D G S     |
| BS170_D27Z  | TO-92   | Tape and Reel | FORMING    | D G S     |
| BS170_D74Z  | TO-92   | AMMO          | FORMING    | D G S     |
| BS170_D75Z  | TO-92   | AMMO          | FORMING    | D G S     |
| MMBF170     | SOT-23  | Tape and Reel |            |           |

## Typical Electrical Characteristics

BS170 / MMBF170

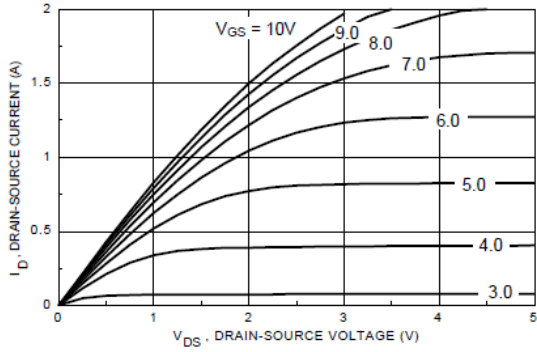

Figure 1. On-Region Characteristics.

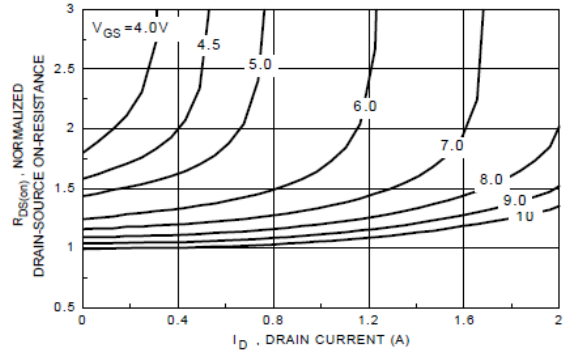

Figure 2. On-Resistance Variation with Gate Voltage and Drain Current.

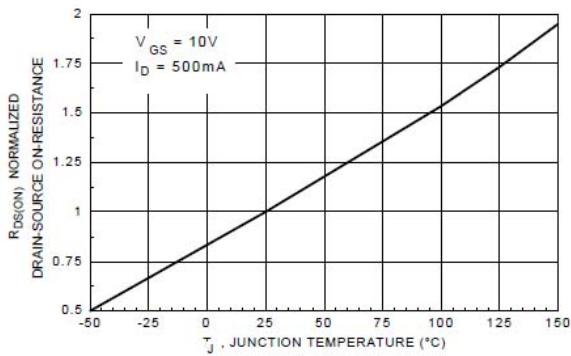

Figure 3. On-Resistance Variation with Temperature.

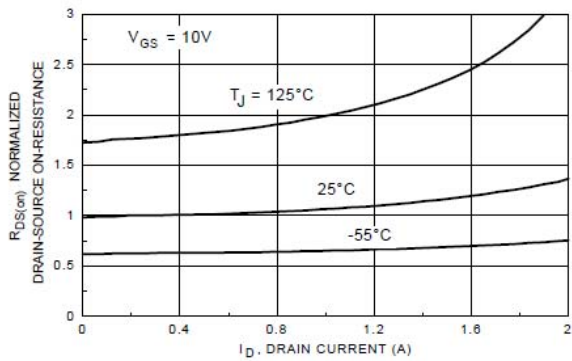

Figure 4. On-Resistance Variation with Drain Current and Temperature.

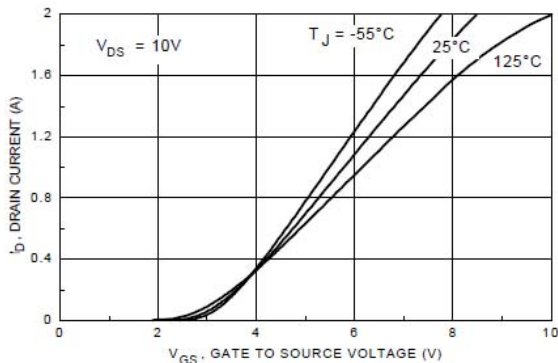

Figure 5. Transfer Characteristics.

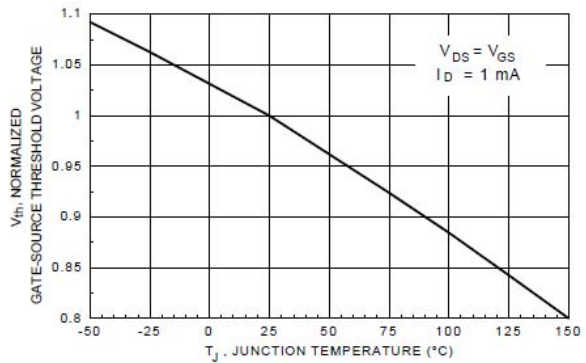

Figure 6. Gate Threshold Variation with Temperature.

Typical Electrical Characteristics (continued)

BS170 / MMBF170

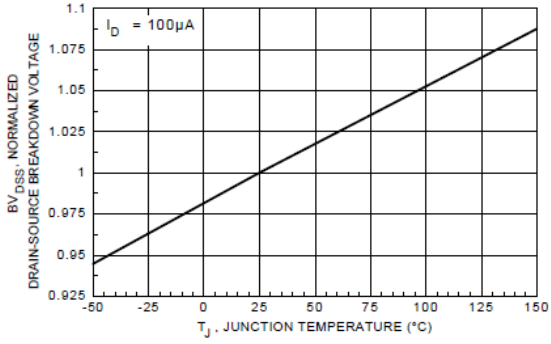

Figure 7. Breakdown Voltage Variation with Temperature.

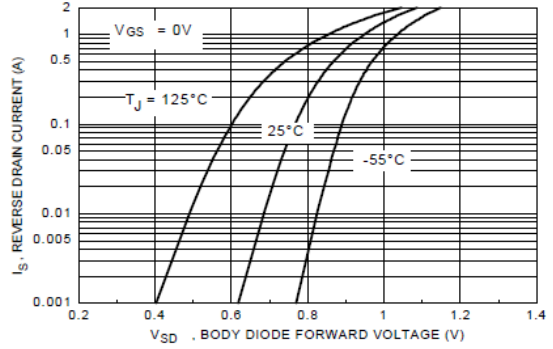

Figure 8. Body Diode Forward Voltage Variation with Current and Temperature.

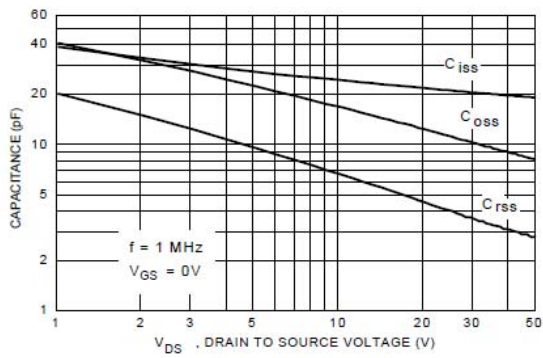

Figure 9. Capacitance Characteristics.

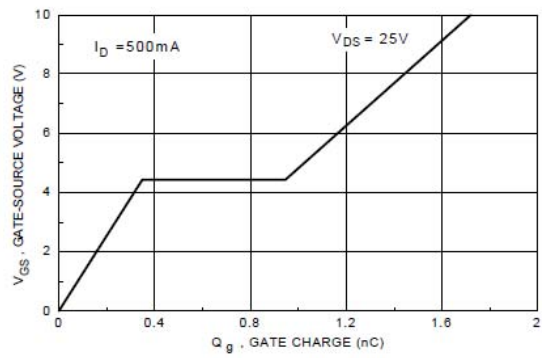

Figure 10. Gate Charge Characteristics.

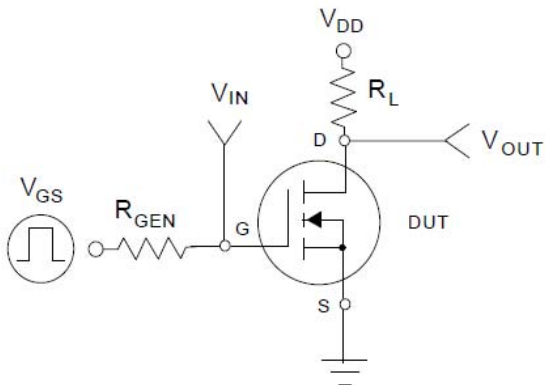

Figure 11. Switching Test Circuit.

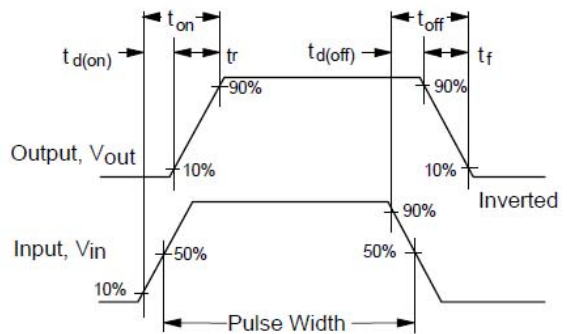

Figure 12. Switching Waveforms.

Typical Electrical Characteristics (continued)

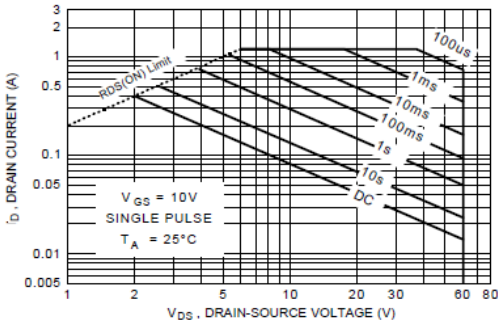

Figure 13. BS170 Maximum Safe Operating Area.

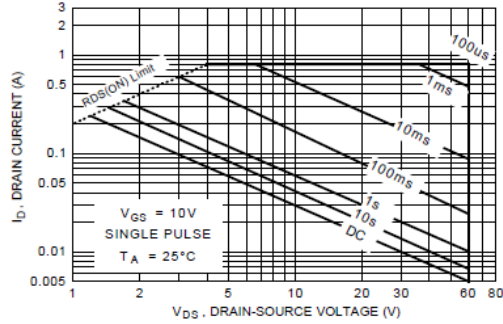

Figure 14. MMBF170 Maximum Safe Operating Area.

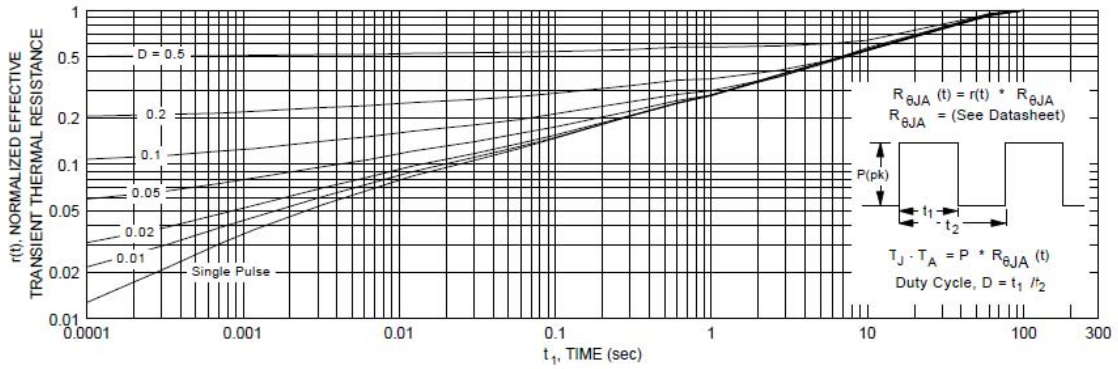

Figure 15. TO-92, BS170 Transient Thermal Response Curve.

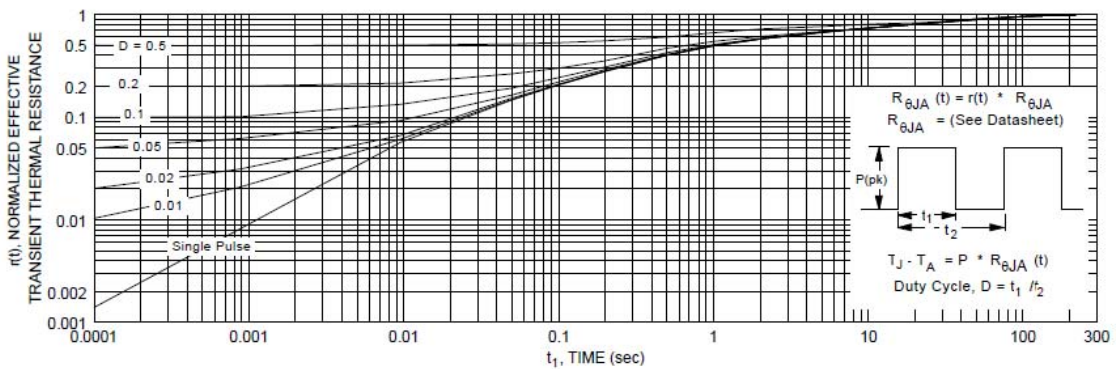

Figure 16. SOT-23, MMBF170 Transient Thermal Response Curve.

### TO-92 Tape and Reel Data

#### TO-92 Packaging Configuration: Figure 1.0



#### TAPE and REEL OPTION See Fig 2.0 for various Reeling Styles

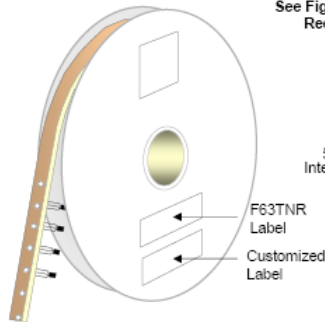

5 Reels per Intermediate Box

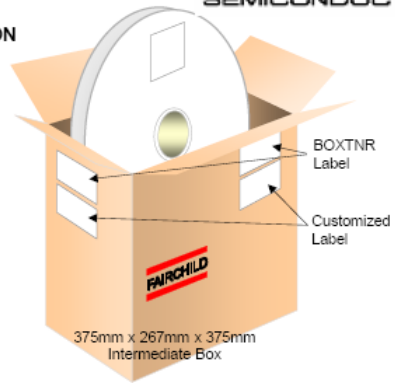

#### AMMO PACK OPTION See Fig 3.0 for 2 Ammo Pack Options

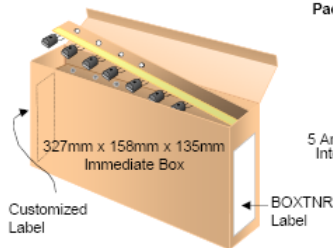

5 Ammo boxes per Intermediate Box

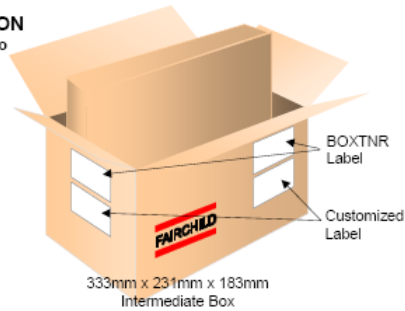

#### BULK OPTION See Bulk Packing Information table

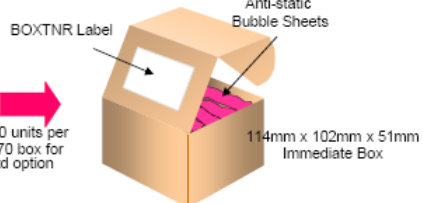

5 EO70 boxes per Intermediate Box

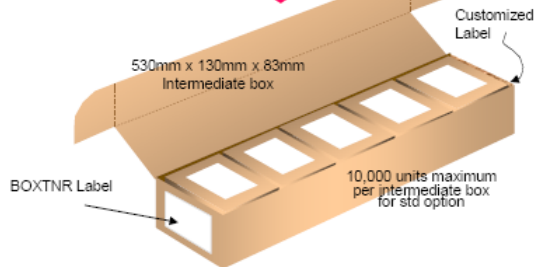

BOXTNR Label sample



F63TNR Label sample



TO-92 Tape and Reel Data, continued



TO-92 Packing

Information: Figure 2.0

TO-92 TNR/AMMO PACKING INFORMATION TABLE

| Packing | Style | Quantity | EOL code |
|---------|-------|----------|----------|
| Reel    | A     | 2,000    | D26Z     |
|         | B     | 2,000    | D11Z     |
|         | C     | 2,000    | D28Z     |
|         | D     | 2,000    | D10Z     |
|         | E     | 2,000    | D27Z     |
|         | F     | 2,000    | D81Z     |
|         | G     | 2,000    | D29Z     |
|         | H     | 2,000    | D89Z     |
| Ammo    | M     | 2,000    | D74Z     |
|         | P     | 2,000    | D75Z     |

Unit weight = 0.22 gm  
 Reel weight with components = 1.04 kg  
 Ammo weight with components = 1.02 kg  
 Max quantity per intermediate box = 10,000 units

TO-92 BULK PACKING INFORMATION TABLE

| EOL CODE / FLOW OPTION | DESCRIPTION           | LEADCLIP DIMENSION | MINIMUM ORDER QTY | LEADFORM OUTLINE |
|------------------------|-----------------------|--------------------|-------------------|------------------|
| NO EOL CODE            | STRAIGHT LEADS        | NO LEAD CLIP       | 2.0K / BOX        |                  |
| J18Z                   | TO-18 OPTION STD      | NO LEAD CLIP       | 2.0K / BOX        |                  |
| J35Z                   | TO-18 OPTION REVERSE  | NO LEAD CLIP       | 2.0K / BOX        |                  |
| J05Z                   | TO-5 OPTION STD       | NO LEAD CLIP       | 1.5K / BOX        |                  |
| J60Z                   | TO-5 OPTION REVERSE   | NO LEAD CLIP       | 1.5K / BOX        |                  |
| J61Z                   | IN LINE 0.200 SPACING | NO LEAD CLIP       | 1.5K / BOX        |                  |



TO-92 Tape and Reel Data, continued

TO-92 Reeling Style  
Configuration: Figure 3.0



Machine Option "A" (H)

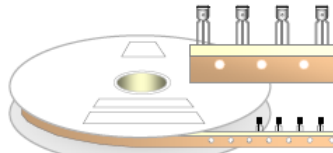

Style "A", D26Z

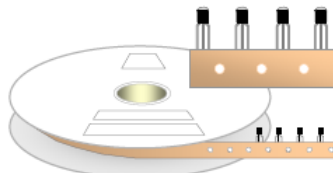

Style "B", D11Z

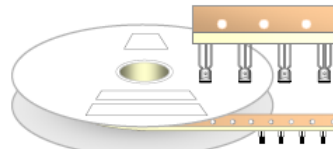

Style "C", D28Z

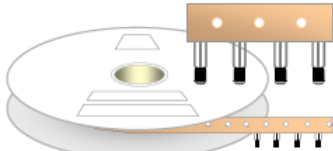

Style "D", D10Z

Machine Option "E" (J)

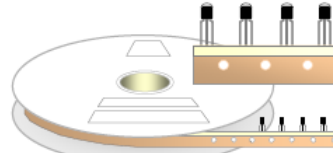

Style "E", D27Z

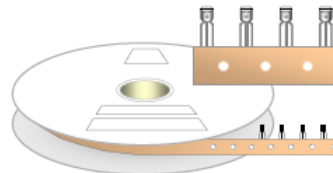

Style "F", D81Z

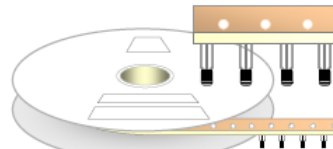

Style "G", D29Z

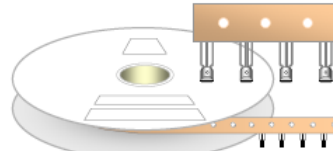

Style "H", D89Z

TO-92 Radial Ammo Packaging  
Configuration: Figure 4.0

FIRST WIRE OFF IS COLLECTOR  
ADHESIVE TAPE IS ON THE TOP SIDE  
FLAT OF TRANSISTOR IS ON TOP

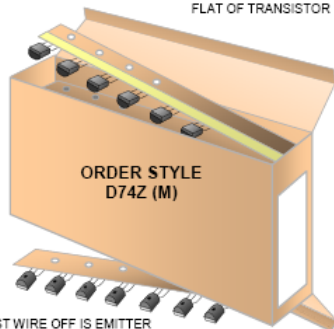

ORDER STYLE  
D74Z (M)

FIRST WIRE OFF IS EMITTER  
ADHESIVE TAPE IS ON BOTTOM SIDE  
FLAT OF TRANSISTOR IS ON BOTTOM

FIRST WIRE OFF IS EMITTER  
ADHESIVE TAPE IS ON THE TOP SIDE  
FLAT OF TRANSISTOR IS ON BOTTOM

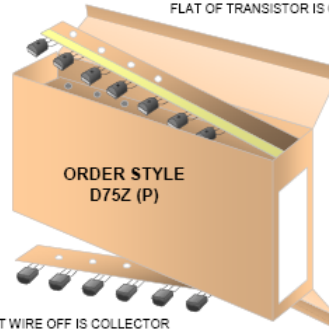

ORDER STYLE  
D75Z (P)

FIRST WIRE OFF IS COLLECTOR  
ADHESIVE TAPE IS ON BOTTOM SIDE  
FLAT OF TRANSISTOR IS ON TOP

## TO-92 Tape and Reel Data, continued

**TO-92 Tape and Reel Taping  
Dimension Configuration: Figure 5.0**

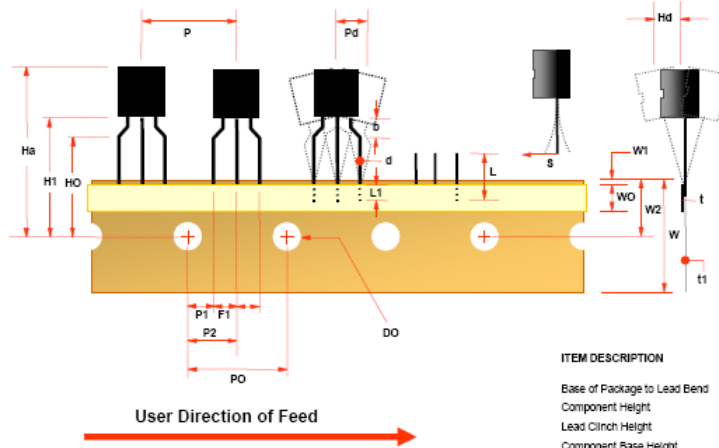

| ITEM DESCRIPTION                   | SYMBOL | DIMENSION              |
|------------------------------------|--------|------------------------|
| Base of Package to Lead Bend       | b      | 0.098 (max)            |
| Component Height                   | Ha     | 0.929 (+/- 0.025)      |
| Lead Clinch Height                 | HO     | 0.630 (+/- 0.020)      |
| Component Base Height              | H1     | 0.748 (+/- 0.020)      |
| Component Alignment ( side/side )  | Pd     | 0.040 (max)            |
| Component Alignment ( front/back ) | Hd     | 0.031 (max)            |
| Component Pitch                    | P      | 0.500 (+/- 0.020)      |
| Feed Hole Pitch                    | PO     | 0.500 (+/- 0.008)      |
| Hole Center to First Lead          | P1     | 0.150 (+0.009, -0.010) |
| Hole Center to Component Center    | P2     | 0.247 (+/- 0.007)      |
| Lead Spread                        | F1/F2  | 0.104 (+/- 0.010)      |
| Lead Thickness                     | d      | 0.018 (+0.002, -0.003) |
| Cut Lead Length                    | L      | 0.429 (max)            |
| Taped Lead Length                  | L1     | 0.209 (+0.051, -0.052) |
| Taped Lead Thickness               | t      | 0.032 (+/- 0.006)      |
| Carrier Tape Thickness             | t1     | 0.021 (+/- 0.006)      |
| Carrier Tape Width                 | W      | 0.708 (+0.020, -0.019) |
| Hold - down Tape Width             | WO     | 0.236 (+/- 0.012)      |
| Hold - down Tape position          | W1     | 0.035 (max)            |
| Feed Hole Position                 | W2     | 0.360 (+/- 0.025)      |
| Sprocket Hole Diameter             | DO     | 0.157 (+0.008, -0.007) |
| Lead Spring Out                    | S      | 0.004 (max)            |

**TO-92 Reel  
Configuration: Figure 6.0**

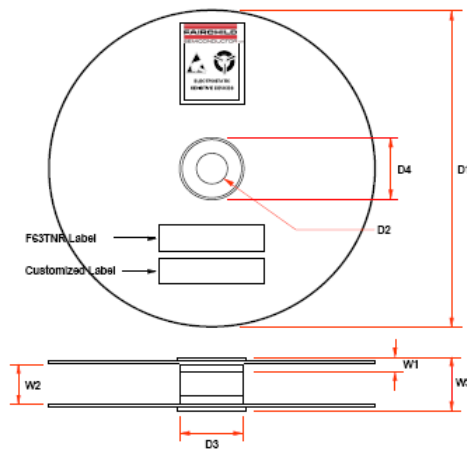

Note : All dimensions are in inches.

| ITEM DESCRIPTION               | SYMBOL | MINIMUM | MAXIMUM |
|--------------------------------|--------|---------|---------|
| Reel Diameter                  | D1     | 13.975  | 14.025  |
| Arbor Hole Diameter (Standard) | D2     | 1.160   | 1.200   |
| (Small Hole)                   | D2     | 0.650   | 0.700   |
| Core Diameter                  | D3     | 3.100   | 3.300   |
| Hub Recess Inner Diameter      | D4     | 2.700   | 3.100   |
| Hub Recess Depth               | W1     | 0.370   | 0.570   |
| Flange to Flange Inner Width   | W2     | 1.630   | 1.690   |
| Hub to Hub Center Width        | W3     |         | 2.090   |

Note: All dimensions are inches

**Mechanical Dimensions ( TO-92 )**

**TO-92**

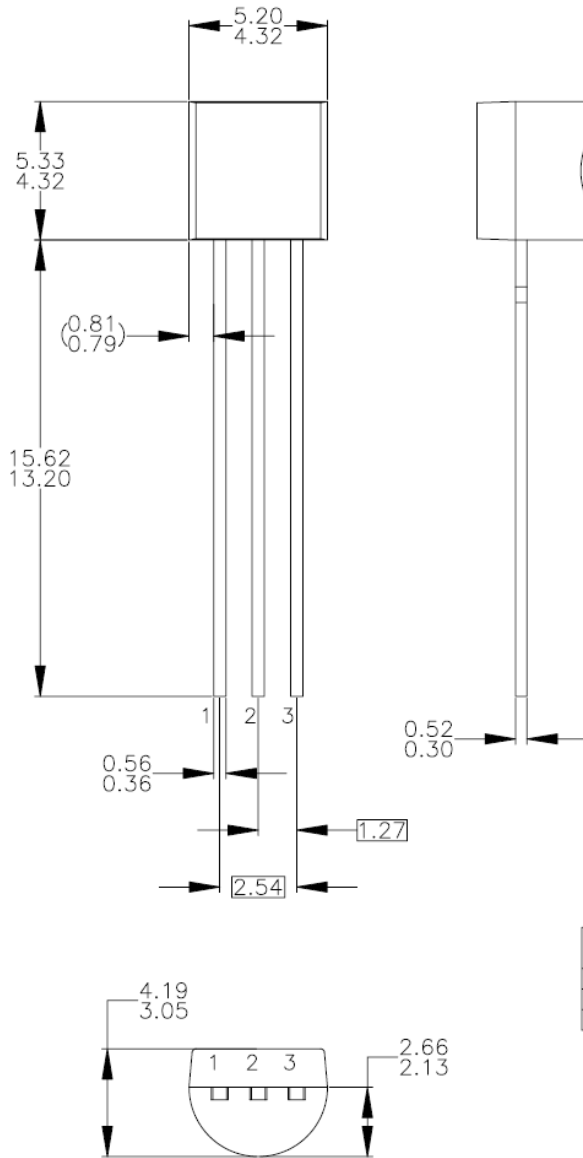

NOTES: UNLESS OTHERWISE SPECIFIED

- A) DRAWING WITH REFERENCE TO JEDEC TO-92 RECOMMENDATIONS.
- B) ALL DIMENSIONS ARE IN MILLIMETERS.
- C) DRAWING CONFORMS TO ASME Y14.5M-1994.
- D) TO-92 (92,94,96,97,98) PIN CONFIGURATION:

| PIN | 92 |   |   | 94 |   |   | 96 |   |   | 97 |   |   | 98 |   |   |
|-----|----|---|---|----|---|---|----|---|---|----|---|---|----|---|---|
|     | P  | F | M | P  | F | M | P  | F | M | P  | F | M | P  | F | M |
| 1   | E  | S | S | E  | S | S | B  | D | G | C  | G | D | C  | G | D |
| 2   | B  | D | G | C  | G | D | E  | S | S | B  | D | G | E  | S | S |
| 3   | C  | G | D | B  | D | G | C  | G | D | E  | S | S | B  | D | G |

LEGEND:

- P - BIPOLAR      E - EMITTER      D - DRAIN
- F - JFET          B - BASE          S - SOURCE
- M - DMOS        C - COLLECTOR    G - GATE

- E) FOR PACKAGE 92, 94, 96, 97 AND 98:  
PIN CONFIGURATION DRAIN "D" AND SOURCE "S"  
ARE INTERCHANGEABLE AT JFET "F" OPTION.
- F) DRAWING FILENAME: MKT-2A03DREV3.

Dimensions in Millimeters

# SOT-23 Std Tape and Reel Data



## SOT23-3L Packaging Configuration: Figure 1.0

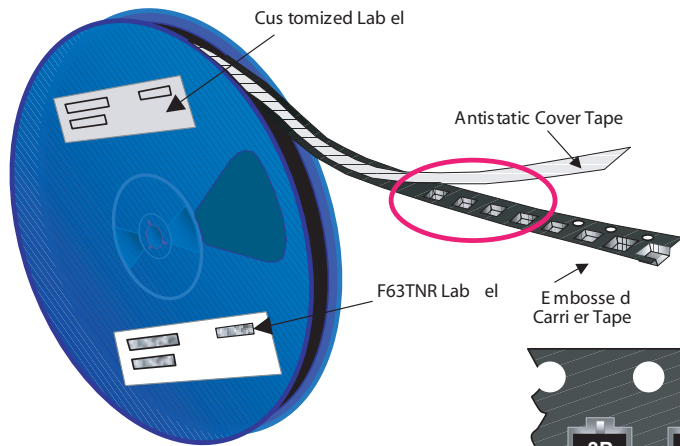

### Packaging Description:

SOT23-3L parts are shipped in tape. The carrier tape is made from a dissipative (carbon filled) polycarbonate resin. The cover tape is a multilayer film (Heat Activated Adhesive in nature) primarily composed of polyester film, adhesive layer, sealant, and anti-static sprayed agent. These reeled parts in standard option are shipped with 3,000 units per 7" or 177mm diameter reel. The reels are dark blue in color and is made of polystyrene plastic (anti-static coated). Other option comes in 10,000 units per 13" or 330mm diameter reel. This and some other options are described in the Packaging Information table.

These full reels are individually labeled and placed inside a standard intermediate box made of recyclable corrugated brown paper with a Fairchild logo printing. One box contains five reels maximum. And these intermediate boxes are placed inside a labeled shipping box which comes in different sizes depending on the number of parts shipped.

| SOT23-3L Packaging Information |                         |            |
|--------------------------------|-------------------------|------------|
| Packaging Option               | Standard (no flow code) | D87Z       |
| Packaging type                 | TNR                     | TNR        |
| Qty per Reel/Tube/Bag          | 3,000                   | 10,000     |
| Reel Size                      | 7" Dia                  | 13"        |
| Box Dimension (mm)             | 193x183x80              | 355x333x40 |
| Max qty per Box                | 15,000                  | 30,000     |
| Weight per unit (gm)           | 0.0082                  | 0.0082     |
| Weight per Reel (kg)           | 0.1175                  | 0.4006     |
| Note/Comments                  |                         |            |

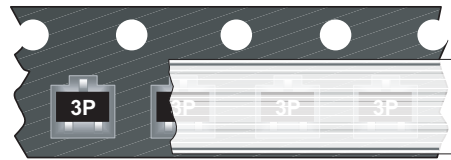

### SOT23-3L Unit Orientation

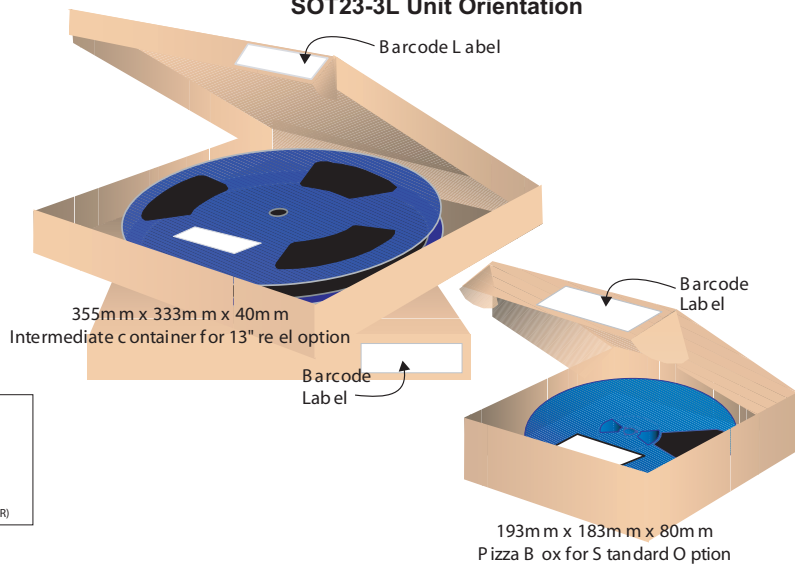

### Barcode Label sample

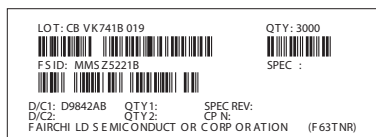

## SOT23-3L Tape Leader and Trailer Configuration: Figure 2.0

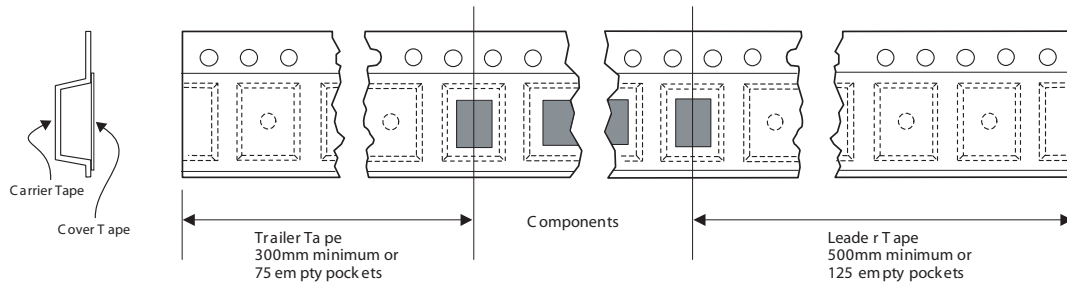

## SOT-23 Std Tape and Reel Data, continued

### SOT23-3L Embossed Carrier Tape Configuration: Figure 3.0

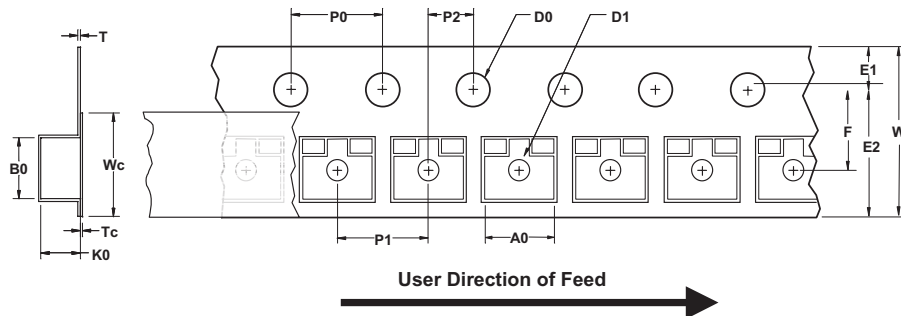

| Dimensions are in millimeter |                 |                 |               |                 |                   |                 |             |                 |               |               |                 |                   |               |                 |
|------------------------------|-----------------|-----------------|---------------|-----------------|-------------------|-----------------|-------------|-----------------|---------------|---------------|-----------------|-------------------|---------------|-----------------|
| Pkg type                     | A0              | B0              | W             | D0              | D1                | E1              | E2          | F               | P1            | P0            | K0              | T                 | Wc            | Tc              |
| SOT-23<br>(8mm)              | 3.15<br>+/-0.10 | 2.77<br>+/-0.10 | 8.0<br>+/-0.3 | 1.55<br>+/-0.05 | 1.125<br>+/-0.125 | 1.75<br>+/-0.10 | 6.25<br>min | 3.50<br>+/-0.05 | 4.0<br>+/-0.1 | 4.0<br>+/-0.1 | 1.30<br>+/-0.10 | 0.228<br>+/-0.013 | 5.2<br>+/-0.3 | 0.06<br>+/-0.02 |

Notes: A0, B0, and K0 dimensions are determined with respect to the EIA/Jedec RS-481 rotational and lateral movement requirements (see sketches A, B, and C).

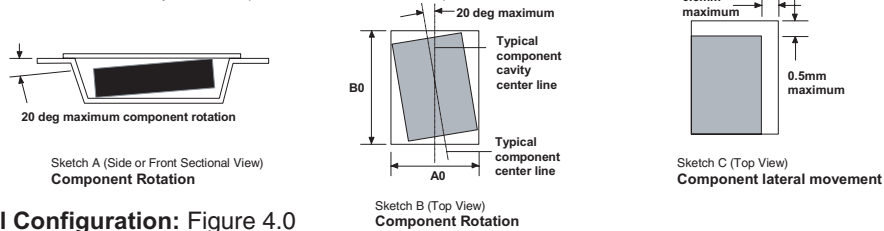

### SOT23-3L Reel Configuration: Figure 4.0

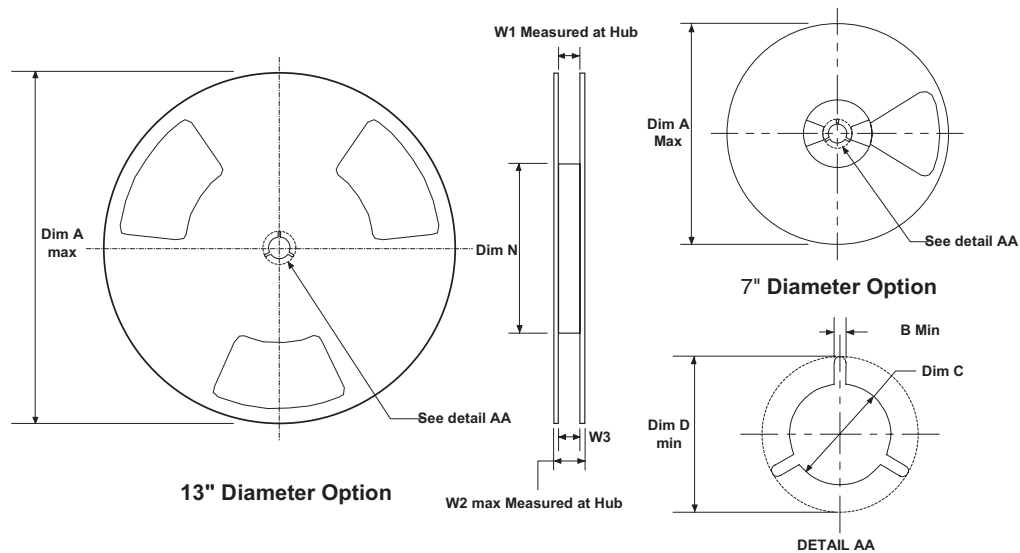

| Dimensions are in inches and millimeters |             |               |              |                                   |               |             |                                   |               |                             |
|--|-------------|---------------|--------------|-----------------------------------|---------------|-------------|-----------------------------------|---------------|-----------------------------|
| Tape Size                                | Reel Option | Dim A         | Dim B        | Dim C                             | Dim D         | Dim N       | Dim W1                            | Dim W2        | Dim W3 (LSL-USL)            |
| 8mm                                      | 7" Dia      | 7.00<br>177.8 | 0.059<br>1.5 | 512 +0.020/-0.008<br>13 +0.5/-0.2 | 0.795<br>20.2 | 2.165<br>55 | 0.331 +0.059/-0.000<br>8.4 +1.5/0 | 0.567<br>14.4 | 0.311 - 0.429<br>7.9 - 10.9 |
| 8mm                                      | 13" Dia     | 13.00<br>330  | 0.059<br>1.5 | 512 +0.020/-0.008<br>13 +0.5/-0.2 | 0.795<br>20.2 | 4.00<br>100 | 0.331 +0.059/-0.000<br>8.4 +1.5/0 | 0.567<br>14.4 | 0.311 - 0.429<br>7.9 - 10.9 |

Mechanical Dimensions ( SOT-23 )

SOT-23

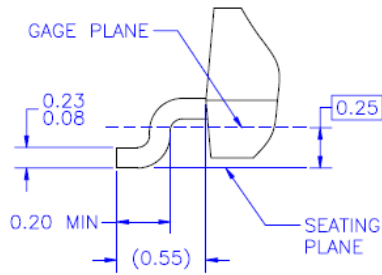
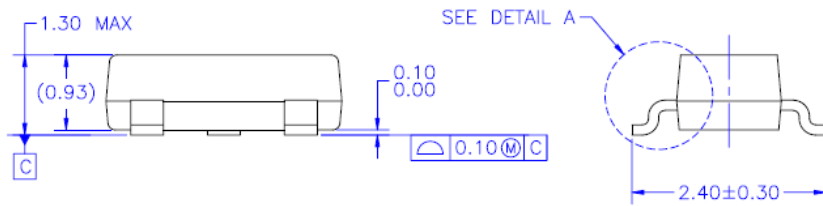
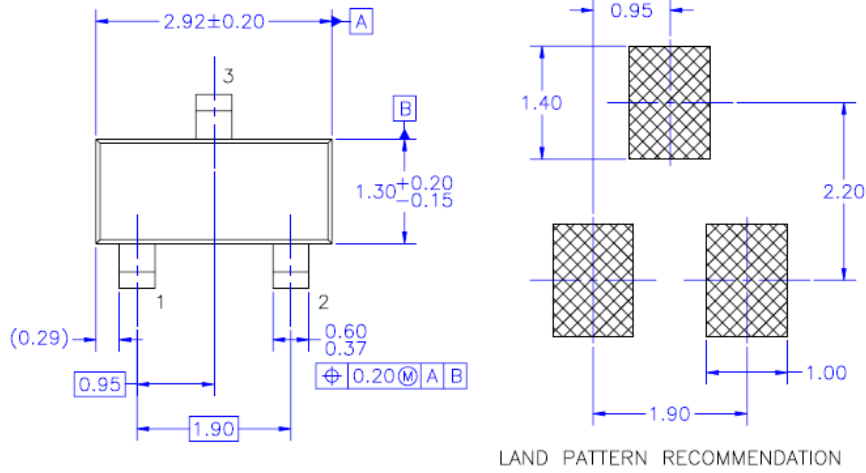

NOTES: UNLESS OTHERWISE SPECIFIED





- A) REFERENCE JEDEC REGISTRATION TO-236, VARIATION AB, ISSUE H.
- B) ALL DIMENSIONS ARE IN MILLIMETERS.
- C) DIMENSIONS ARE INCLUSIVE OF BURRS, MOLD FLASH AND TIE BAR EXTRUSIONS.
- D) DIMENSIONING AND TOLERANCING PER ASME Y14.5M — 1994.
- E) DRAWING FILE NAME: MA03DREV9

Dimensions in Millimeters



**TRADEMARKS**

The following includes registered and unregistered trademarks and service marks, owned by Fairchild Semiconductor and/or its global subsidiaries, and is not intended to be an exhaustive list of all such trademarks.

|                          |   |   |   |
|--------------------------|---|---|---|
| AccuPower™               | FRFET®  | PowerTrench®  | The Power Franchise®  |
| Auto-SPM™                | Global Power Resource <sup>SM</sup>   | PowerXS™  | the <b>power</b> ™  |
| Build it Now™            | Green FPS™  | Programmable Active Droop™  | franchise   |
| CorePLUS™                | Green FPS™ e-Series™  | QFET®   | TinyBoost™  |
| CorePOWER™               | Gmax™   | QS™   | TinyBuck™   |
| CROSSVOLT™               | GTO™  | Quiet Series™   | TinyCalc™   |
| CTL™                     | IntelliMAX™   | RapidConfigure™   | TinyLogic®  |
| Current Transfer Logic™  | ISOPLANAR™  |  ™ | TINYOPTO™   |
| DEUXPEED®                | MegaBuck™   | Saving our world, 1mW/W/kW at a time™   | TinyPower™  |
| Dual Cool™               | MICROCOUPLER™   | SignalWise™   | TinyPWM™  |
| EcoSPARK®                | MicroFET™   | SmartMax™   | TinyWire™   |
| EfficientMax™            | MicroPak™   | SMART START™  | TriFault Detect™  |
| <b>f</b> ®               | MicroPak2™  | SPM®  | TRUECURRENT™*   |
| Fairchild®               | MillerDrive™  | STEALTH™  | µSerDes™  |
| Fairchild Semiconductor® | MotionMax™  | SuperFET™   |  ™ |
| FACT Quiet Series™       | Motion-SPM™   | SuperSOT™-3   | UHC®  |
| FACT®                    | OptoHiT™  | SuperSOT™-6   | Ultra FRFET™  |
| FAST®                    | OPTOLOGIC®  | SuperSOT™-8   | UniFET™   |
| FastvCore™               | OPTOPLANAR®   | SupreMOS™   | VCX™  |
| FETBench™                |  ® | SyncFET™  | VisualMax™  |
| FlashWriter®*            | PDP SPM™  | Sync-Lock™  | XS™   |
| FPS™                     | Power-SPM™  |  ™ |   |
| F-PFS™                   |   |   |   |

\* Trademarks of System General Corporation, used under license by Fairchild Semiconductor.

**DISCLAIMER**

FAIRCHILD SEMICONDUCTOR RESERVES THE RIGHT TO MAKE CHANGES WITHOUT FURTHER NOTICE TO ANY PRODUCTS HEREIN TO IMPROVE RELIABILITY, FUNCTION, OR DESIGN. FAIRCHILD DOES NOT ASSUME ANY LIABILITY ARISING OUT OF THE APPLICATION OR USE OF ANY PRODUCT OR CIRCUIT DESCRIBED HEREIN; NEITHER DOES IT CONVEY ANY LICENSE UNDER ITS PATENT RIGHTS, NOR THE RIGHTS OF OTHERS. THESE SPECIFICATIONS DO NOT EXPAND THE TERMS OF FAIRCHILD'S WORLDWIDE TERMS AND CONDITIONS, SPECIFICALLY THE WARRANTY THEREIN, WHICH COVERS THESE PRODUCTS.

**LIFE SUPPORT POLICY**

FAIRCHILD'S PRODUCTS ARE NOT AUTHORIZED FOR USE AS CRITICAL COMPONENTS IN LIFE SUPPORT DEVICES OR SYSTEMS WITHOUT THE EXPRESS WRITTEN APPROVAL OF FAIRCHILD SEMICONDUCTOR CORPORATION.

As used herein:

1. Life support devices or systems are devices or systems which, (a) are intended for surgical implant into the body or (b) support or sustain life, and (c) whose failure to perform when properly used in accordance with instructions for use provided in the labeling, can be reasonably expected to result in a significant injury of the user.
2. A critical component in any component of a life support, device, or system whose failure to perform can be reasonably expected to cause the failure of the life support device or system, or to affect its safety or effectiveness.

**ANTI-COUNTERFEITING POLICY**

Fairchild Semiconductor Corporation's Anti-Counterfeiting Policy. Fairchild's Anti-Counterfeiting Policy is also stated on our external website, [www.fairchildsemi.com](http://www.fairchildsemi.com), under Sales Support.

Counterfeiting of semiconductor parts is a growing problem in the industry. All manufacturers of semiconductor products are experiencing counterfeiting of their parts. Customers who inadvertently purchase counterfeit parts experience many problems such as loss of brand reputation, substandard performance, failed applications, and increased cost of production and manufacturing delays. Fairchild is taking strong measures to protect ourselves and our customers from the proliferation of counterfeit parts. Fairchild strongly encourages customers to purchase Fairchild parts either directly from Fairchild or from Authorized Fairchild Distributors who are listed by country on our web page cited above. Products customers buy either from Fairchild directly or from Authorized Fairchild Distributors are genuine parts, have full traceability, meet Fairchild's quality standards for handling and storage and provide access to Fairchild's full range of up-to-date technical and product information. Fairchild and our Authorized Distributors will stand behind all warranties and will appropriately address any warranty issues that may arise. Fairchild will not provide any warranty coverage or other assistance for parts bought from Unauthorized Sources. Fairchild is committed to combat this global problem and encourage our customers to do their part in stopping this practice by buying direct or from authorized distributors.

**PRODUCT STATUS DEFINITIONS**

**Definition of Terms**

| Datasheet Identification | Product Status        | Definition  |
|--------------------------|-----------------------|---|
| Advance Information      | Formative / In Design | Datasheet contains the design specifications for product development. Specifications may change in any manner without notice.   |
| Preliminary              | First Production      | Datasheet contains preliminary data; supplementary data will be published at a later date. Fairchild Semiconductor reserves the right to make changes at any time without notice to improve design. |
| No Identification Needed | Full Production       | Datasheet contains final specifications. Fairchild Semiconductor reserves the right to make changes at any time without notice to improve the design.   |
| Obsolete                 | Not In Production     | Datasheet contains specifications on a product that is discontinued by Fairchild Semiconductor. The datasheet is for reference information only.  |

Rev. I47

ON Semiconductor and  are trademarks of Semiconductor Components Industries, LLC dba ON Semiconductor or its subsidiaries in the United States and/or other countries. ON Semiconductor owns the rights to a number of patents, trademarks, copyrights, trade secrets, and other intellectual property. A listing of ON Semiconductor's product/patent coverage may be accessed at [www.onsemi.com/site/pdf/Patent-Marking.pdf](http://www.onsemi.com/site/pdf/Patent-Marking.pdf). ON Semiconductor reserves the right to make changes without further notice to any products herein. ON Semiconductor makes no warranty, representation or guarantee regarding the suitability of its products for any particular purpose, nor does ON Semiconductor assume any liability arising out of the application or use of any product or circuit, and specifically disclaims any and all liability, including without limitation special, consequential or incidental damages. Buyer is responsible for its products and applications using ON Semiconductor products, including compliance with all laws, regulations and safety requirements or standards, regardless of any support or applications information provided by ON Semiconductor. "Typical" parameters which may be provided in ON Semiconductor data sheets and/or specifications can and do vary in different applications and actual performance may vary over time. All operating parameters, including "Typicals" must be validated for each customer application by customer's technical experts. ON Semiconductor does not convey any license under its patent rights nor the rights of others. ON Semiconductor products are not designed, intended, or authorized for use as a critical component in life support systems or any FDA Class 3 medical devices or medical devices with a same or similar classification in a foreign jurisdiction or any devices intended for implantation in the human body. Should Buyer purchase or use ON Semiconductor products for any such unintended or unauthorized application, Buyer shall indemnify and hold ON Semiconductor and its officers, employees, subsidiaries, affiliates, and distributors harmless against all claims, costs, damages, and expenses, and reasonable attorney fees arising out of, directly or indirectly, any claim of personal injury or death associated with such unintended or unauthorized use, even if such claim alleges that ON Semiconductor was negligent regarding the design or manufacture of the part. ON Semiconductor is an Equal Opportunity/Affirmative Action Employer. This literature is subject to all applicable copyright laws and is not for resale in any manner.

## PUBLICATION ORDERING INFORMATION

### LITERATURE FULFILLMENT:

Literature Distribution Center for ON Semiconductor  
19521 E. 32nd Pkwy, Aurora, Colorado 80011 USA  
**Phone:** 303-675-2175 or 800-344-3860 Toll Free USA/Canada  
**Fax:** 303-675-2176 or 800-344-3867 Toll Free USA/Canada  
**Email:** [orderlit@onsemi.com](mailto:orderlit@onsemi.com)

**N. American Technical Support:** 800-282-9855 Toll Free  
USA/Canada  
**Europe, Middle East and Africa Technical Support:**  
Phone: 421 33 790 2910  
**Japan Customer Focus Center**  
Phone: 81-3-5817-1050

**ON Semiconductor Website:** [www.onsemi.com](http://www.onsemi.com)  
**Order Literature:** <http://www.onsemi.com/orderlit>  
For additional information, please contact your local  
Sales Representative