

MMQA Quad Common Anode Series

Preferred Devices

SC-74 Quad Monolithic Common Anode

Transient Voltage Suppressors for ESD Protection

This quad monolithic silicon voltage suppressor is designed for applications requiring transient overvoltage protection capability. It is intended for use in voltage and ESD sensitive equipment such as computers, printers, business machines, communication systems, medical equipment, and other applications. Its quad junction common anode design protects four separate lines using only one package. These devices are ideal for situations where board space is at a premium.

Features

- SC-74 Package Allows Four Separate Unidirectional Configurations
- Peak Power - Min. 24 W @ 1.0 ms (Unidirectional), per Figure 5 Waveform
- Peak Power - Min. 150 W @ 20 μ s (Unidirectional), per Figure 6 Waveform
- Maximum Clamping Voltage @ Peak Pulse Current
- Low Leakage < 2.0 μ A
- ESD Rating of Class N (exceeding 16 kV) per the Human Body Model
- Pb-Free Packages are Available

THERMAL CHARACTERISTICS ($T_A = 25^\circ\text{C}$ unless otherwise noted)

Characteristic	Symbol	Value	Unit
Peak Power Dissipation @ 1.0 ms (Note 1) @ $T_A \leq 25^\circ\text{C}$	P_{pk}	24	W
Peak Power Dissipation @ 20 μ s (Note 2) @ $T_A \leq 25^\circ\text{C}$	P_{pk}	150	W
Total Power Dissipation on FR-5 Board (Note 3) @ $T_A = 25^\circ\text{C}$	P_D	225 1.8	mW mW/ $^\circ\text{C}$
Thermal Resistance from Junction-to-Ambient	$R_{\theta JA}$	556	$^\circ\text{C}/\text{W}$
Total Power Dissipation on Alumina Substrate (Note 4) @ $T_A = 25^\circ\text{C}$ Derate above 25°C	P_D	300 2.4	mW mW/ $^\circ\text{C}$
Thermal Resistance from Junction-to-Ambient	$R_{\theta JA}$	417	$^\circ\text{C}/\text{W}$
Junction and Storage Temperature Range	T_J, T_{stg}	- 55 to +150	$^\circ\text{C}$
Lead Solder Temperature - Maximum (10 Second Duration)	T_L	260	$^\circ\text{C}$



ON Semiconductor®

<http://onsemi.com>

SC-74 QUAD TRANSIENT VOLTAGE SUPPRESSOR 24 WATTS PEAK POWER 5.6 - 33 VOLTS

PIN ASSIGNMENT



SC-74
PLASTIC
CASE 318F

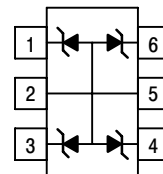

- PIN 1. CATHODE
2. ANODE
3. CATHODE
4. CATHODE
5. ANODE
6. CATHODE

MARKING DIAGRAM

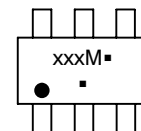

- xxx = Device Code
M = Date Code*
▪ = Pb-Free Package
(Note: Microdot may be in either location)

*Date Code orientation may vary depending upon manufacturing location.

DEVICE MARKING INFORMATION

See specific marking information in the device marking table on page 5 of this data sheet.

ORDERING INFORMATION

See detailed ordering and shipping information in the table on page 5 of this data sheet.

Preferred devices are recommended choices for future use and best overall value.

MMQA Quad Common Anode Series

ELECTRICAL CHARACTERISTICS ($T_A = 25^\circ\text{C}$ unless otherwise noted)

UNIDIRECTIONAL

(Circuit tied to pins 1, 2, and 5; Pins 2, 3, and 5; Pins 2, 4, and 5; or Pins 2, 5, and 6) ($V_F = 0.9\text{ V Max @ } I_F = 10\text{ mA}$)

Device	Breakdown Voltage			Max Reverse Leakage Current			Max Zener Impedance (Note 7)	Max Reverse Surge Current	Max Reverse Voltage @ I_{RSM} (Note 6) (Clamping Voltage)	Maximum Temperature Coefficient of V_Z	Capacitance @ 0 Volt Bias, 1 MHz	
	Min	Nom	Max	@ I_{ZT}	I_R	V_R					Min	Max
MMQA5V6T1,T3	5.32	5.6	5.88	1.0	2000	3.0	400	3.0	8.0	1.26	-	-
MMQA6V2T1,T3	5.89	6.2	6.51	1.0	700	4.0	300	2.66	9.0	10.6	-	-
MMQA6V8T1,T3	6.46	6.8	7.14	1.0	500	4.3	300	2.45	9.8	10.9	100	250
MMQA12VT1,T3	11.4	12	12.6	1.0	75	9.1	80	1.39	17.3	14	-	-
MMQA13VT1	12.4	13	13.7	1.0	75	9.8	80	1.29	18.6	15	-	-
MMQA15VT1,T3	14.3	15	15.8	1.0	75	11	80	1.1	21.7	16	-	-
MMQA18VT1,T3	17.1	18	18.9	1.0	75	14	80	0.923	26	19	-	-
MMQA20VT1,T3	19	20	21	1.0	75	15	80	0.84	28.6	20.1	-	-
MMQA21VT1,T3	20	21	22.1	1.0	75	16	80	0.792	30.3	21	-	-
MMQA22VT1,T3	20.9	22	23.1	1.0	75	17	80	0.758	31.7	22	-	-
MMQA24VT1,T3	22.8	24	25.2	1.0	75	18	100	0.694	34.6	25	-	-
MMQA27VT1,T3	25.7	27	28.4	1.0	75	21	125	0.615	39	28	-	-
MMQA33VT1,T3	31.4	33	34.7	1.0	75	25	200	0.504	48.6	37	-	-

1. Non-repetitive current pulse per Figure 5 and derate above $T_A = 25^\circ\text{C}$ per Figure 4.
2. Non-repetitive current pulse per Figure 6 and derate above $T_A = 25^\circ\text{C}$ per Figure 4.
3. FR-5 = $1.0 \times 0.75 \times 0.62$ in.
4. Alumina = $0.4 \times 0.3 \times 0.024$ in., 99.5% alumina
5. V_Z measured at pulse test current I_T at an ambient temperature of 25°C .
6. Surge current waveform per Figure 5 and derate per Figure 4.
7. Z_{ZT} is measured by dividing the AC voltage drop across the device by the AC current supplied. The specified limits are $I_{Z(AC)} = 0.1 I_{Z(DC)}$, with AC frequency = 1 kHz.

TYPICAL CHARACTERISTICS

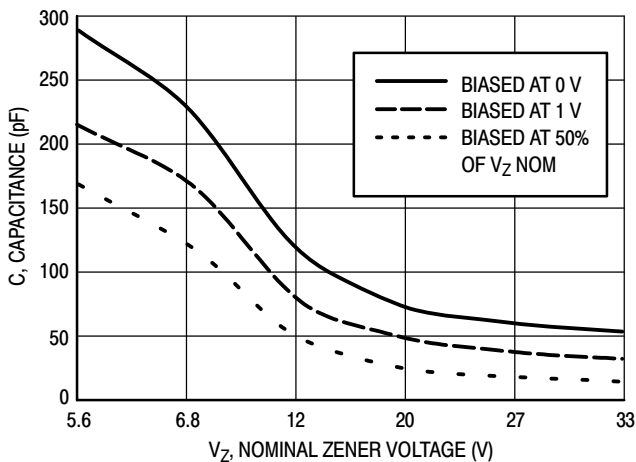

Figure 1. Typical Capacitance

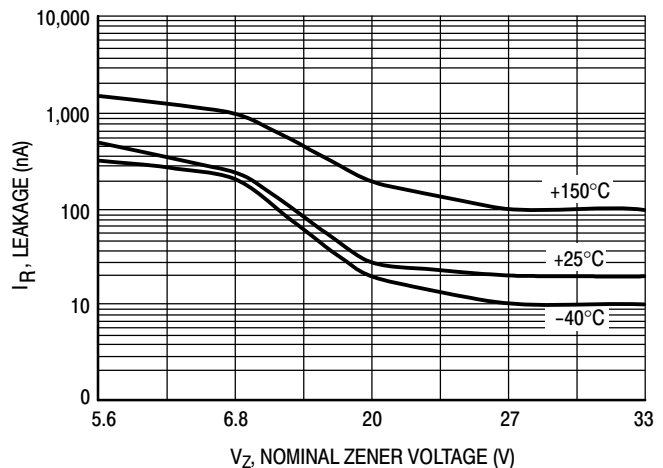

Figure 2. Typical Leakage Current

MMQA Quad Common Anode Series

TYPICAL CHARACTERISTICS

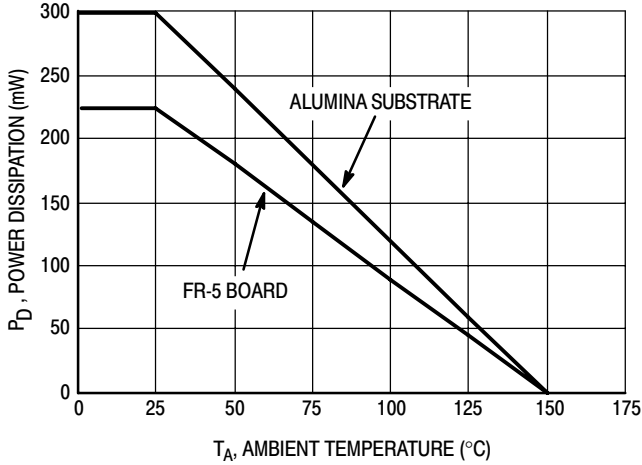

Figure 3. Steady State Power Derating Curve

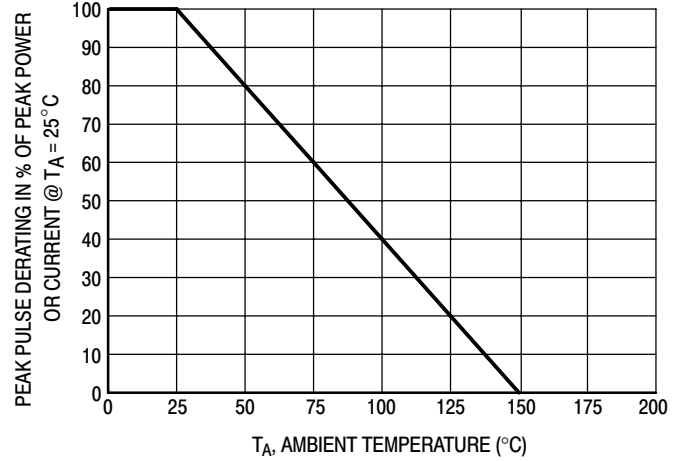

Figure 4. Pulse Derating Curve

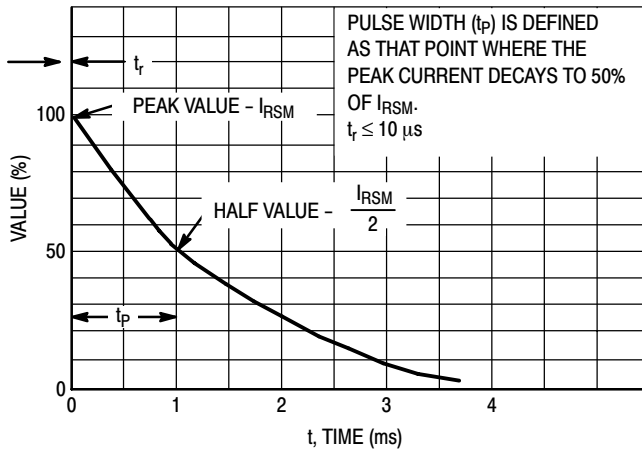

Figure 5. 10 × 1000 µs Pulse Waveform

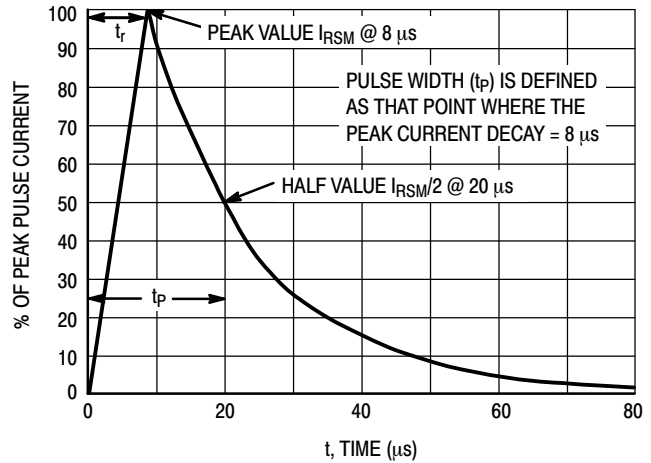

Figure 6. 8 × 20 µs Pulse Waveform

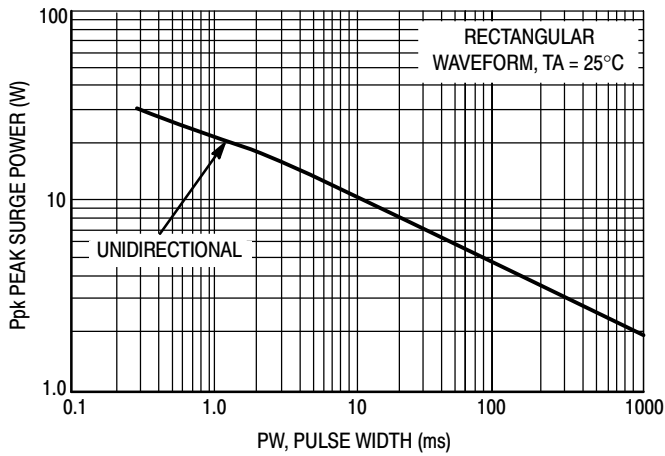

Figure 7. Maximum Non-Repetitive Surge Power, Ppk versus PW

Power is defined as $V_{RSM} \times I_Z(pk)$ where V_{RSM} is the clamping voltage at $I_Z(pk)$.

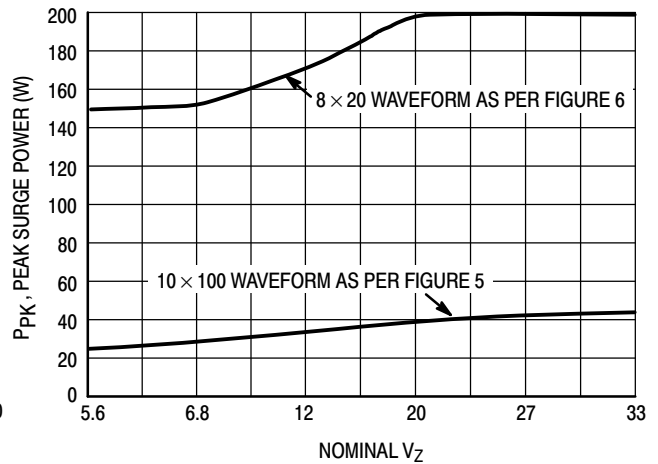

Figure 8. Typical Maximum Non-Repetitive Surge Power, Ppk versus V_{BR}

MMQA Quad Common Anode Series

TYPICAL COMMON ANODE APPLICATIONS

A quad junction common anode design in a SC-74 package protects four separate lines using only one package. This adds flexibility and creativity to PCB design especially

when board space is at a premium. A simplified example of MMQA Series Device applications is illustrated below.

Computer Interface Protection

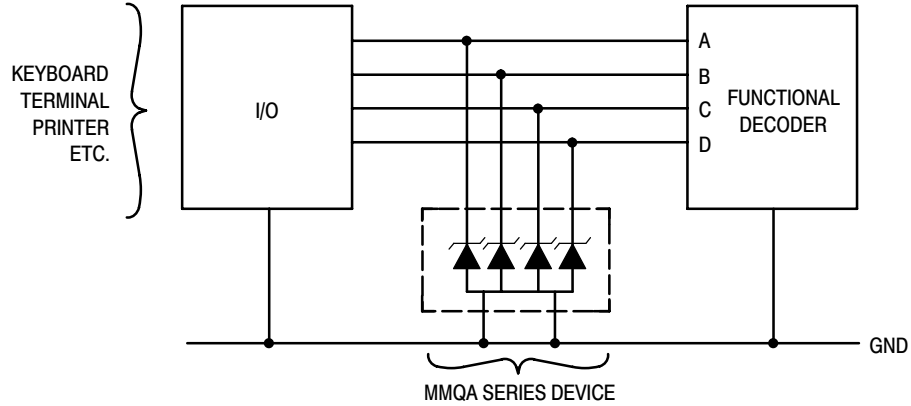

Microprocessor Protection

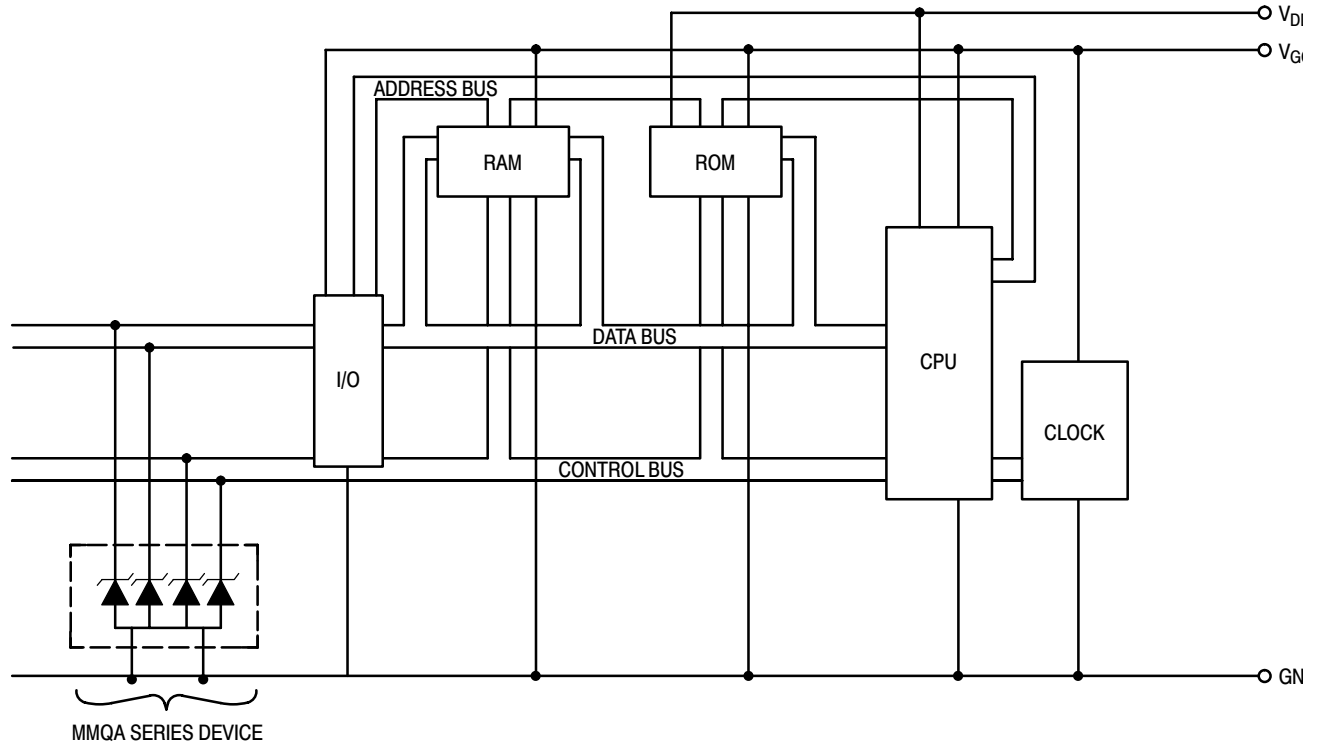

MMQA Quad Common Anode Series

DEVICE MARKING AND ORDERING INFORMATION

Device*	Device Marking	Package	Shipping†
MMQA5V6T1*	5A6	SC-74	3,000/Tape & Reel
MMQA6V2T1*	6A2	SC-74	3,000/Tape & Reel
MMQA6V2T3*	6A2	SC-74	10,000/Tape & Reel
MMQA6V8T1*	6A8	SC-74	3,000/Tape & Reel
MMQA12VT1*	12A	SC-74	3,000/Tape & Reel
MMQA13VT1*	13A	SC-74	3,000/Tape & Reel
MMQA15VT1*	15A	SC-74	3,000/Tape & Reel
MMQA18VT1*	18A	SC-74	3,000/Tape & Reel
MMQA20VT1*	20A	SC-74	3,000/Tape & Reel
MMQA20VT3*	20A	SC-74	10,000/Tape & Reel
MMQA21VT1*	21A	SC-74	3,000/Tape & Reel
MMQA22VT1*	22A	SC-74	3,000/Tape & Reel
MMQA24VT1*	24A	SC-74	3,000/Tape & Reel
MMQA27VT1*	27A	SC-74	3,000/Tape & Reel
MMQA27VT3*	27A	SC-74	10,000/Tape & Reel
MMQA33VT1*	33A	SC-74	3,000/Tape & Reel

†For information on tape and reel specifications, including part orientation and tape sizes, please refer to our Tape and Reel Packaging Specifications Brochure, BRD8011/D.

*The "G" suffix indicates Pb-Free package available.

Mechanical Characteristics:

CASE: Void-free, transfer-molded, thermosetting plastic case.

FINISH: Corrosion resistant finish, easily solderable.

Package designed for optimal automated board assembly.

Small package size for high density applications.

Available in 8 mm Tape and Reel.

Use the Device Number to order the 7 inch/3,000 unit reel.

Replace the "T1" with "T3" in the Device Number to order the 13 inch/10,000 unit reel.

MMQA Quad Common Anode Series

PACKAGE DIMENSIONS

SC-74
CASE 318F-05
ISSUE M

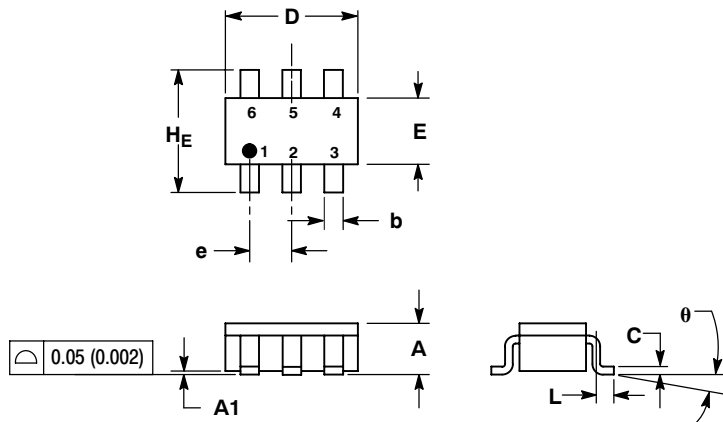

NOTES:

1. DIMENSIONING AND TOLERANCING PER ANSI Y14.5M, 1982.
2. CONTROLLING DIMENSION: INCH.
3. MAXIMUM LEAD THICKNESS INCLUDES LEAD FINISH THICKNESS. MINIMUM LEAD THICKNESS IS THE MINIMUM THICKNESS OF BASE MATERIAL.
4. 318F-01, -02, -03, -04 OBSOLETE. NEW STANDARD 318F-05.

DIM	MILLIMETERS			INCHES		
	MIN	NOM	MAX	MIN	NOM	MAX
A	0.90	1.00	1.10	0.035	0.039	0.043
A1	0.01	0.06	0.10	0.001	0.002	0.004
b	0.25	0.37	0.50	0.010	0.015	0.020
c	0.10	0.18	0.26	0.004	0.007	0.010
D	2.90	3.00	3.10	0.114	0.118	0.122
E	1.30	1.50	1.70	0.051	0.059	0.067
e	0.85	0.95	1.05	0.034	0.037	0.041
L	0.20	0.40	0.60	0.008	0.016	0.024
HE	2.50	2.75	3.00	0.099	0.108	0.118
θ	0°	-	10°	0°	-	10°

STYLE 1:

- PIN 1. CATHODE
- ANODE
- CATHODE
- CATHODE
- ANODE
- CATHODE

SOLDERING FOOTPRINT*

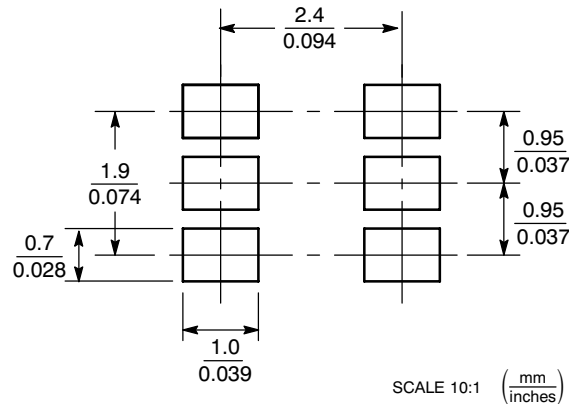

*For additional information on our Pb-Free strategy and soldering details, please download the ON Semiconductor Soldering and Mounting Techniques Reference Manual, SOLDERRM/D.

ON Semiconductor and are registered trademarks of Semiconductor Components Industries, LLC (SCILLC). SCILLC reserves the right to make changes without further notice to any products herein. SCILLC makes no warranty, representation or guarantee regarding the suitability of its products for any particular purpose, nor does SCILLC assume any liability arising out of the application or use of any product or circuit, and specifically disclaims any and all liability, including without limitation special, consequential or incidental damages. "Typical" parameters which may be provided in SCILLC data sheets and/or specifications can and do vary in different applications and actual performance may vary over time. All operating parameters, including "Typicals" must be validated for each customer application by customer's technical experts. SCILLC does not convey any license under its patent rights nor the rights of others. SCILLC products are not designed, intended, or authorized for use as components in systems intended for surgical implant into the body, or other applications intended to support or sustain life, or for any other application in which the failure of the SCILLC product could create a situation where personal injury or death may occur. Should Buyer purchase or use SCILLC products for any such unintended or unauthorized application, Buyer shall indemnify and hold SCILLC and its officers, employees, subsidiaries, affiliates, and distributors harmless against all claims, costs, damages, and expenses, and reasonable attorney fees arising out of, directly or indirectly, any claim of personal injury or death associated with such unintended or unauthorized use, even if such claim alleges that SCILLC was negligent regarding the design or manufacture of the part. SCILLC is an Equal Opportunity/Affirmative Action Employer. This literature is subject to all applicable copyright laws and is not for resale in any manner.

PUBLICATION ORDERING INFORMATION

LITERATURE FULFILLMENT:

Literature Distribution Center for ON Semiconductor
P.O. Box 5163, Denver, Colorado 80217 USA
Phone: 303-675-2175 or 800-344-3860 Toll Free USA/Canada
Fax: 303-675-2176 or 800-344-3867 Toll Free USA/Canada
Email: orderlit@onsemi.com

N. American Technical Support: 800-282-9855 Toll Free
USA/Canada
Europe, Middle East and Africa Technical Support:
Phone: 421 33 790 2910
Japan Customer Focus Center
Phone: 81-3-5773-3850

ON Semiconductor Website: www.onsemi.com

Order Literature: <http://www.onsemi.com/orderlit>

For additional information, please contact your local Sales Representative