

## Features

### Regulated Converters

- Compact High Voltage Power Supplies
- 5 Watt in Low Profile DIP24 Package
- 3000VDC Isolation
- Remote Voltage Programming by External Voltage or Resistance
- Continuous Short Circuit Protection
- Cascadeable to generate Output Voltages of up to 420VDC
- Efficiency to 86%

**INNOLINE**  
DC/DC-Converter

# Rxx- 100\_150A Series

**5 Watt  
Single  
Output**

### Selection Guide

Part Number	Input Range (VDC)	Output Voltage (1) (VDC)	Output Current (2) (mA)
R12-100A	12 ( 10 – 14 )	+55...+135	50
R15-100A	15 ( 13 – 17 )	+55...+135	50
R24-100A	24 ( 21 – 27 )	+55...+135	50
R12-150A	12 ( 10 – 14 )	+95...+210	50
R15-150A	15 ( 13 – 17 )	+95...+210	50
R24-150A	24 ( 21 – 27 )	+95...+210	50

### Notes:

1. Adjustable with external voltage 0 to +4VDC or with 5k. variable resistor. See below for details.
2. Maximum Power Dissipation is 5W.

### Specifications

( typical at 25°C, nominal input voltage, rated output current unless otherwise specified )

Input Voltage Range	10..14 or 13..17 or 21..27VDC
Rated Power	50mA max. or 5 Watts max.
Voltage Adjustment Range ( see note 1 )	55..135 or 95..210VDC
Minimum Load for proper regulation	10mA
Output Voltage Accuracy	±5% max
Line Voltage Regulation	0.2% max
Load Voltage Regulation ( 20% to 100% full load )	0.3% max
Output Ripple and Noise (20MHz limited)	100mVp-p max.
Operating Frequency	200kHz typ.
Efficiency at Full Load	80 ~ 86%
Isolation Voltage (tested for 1 second)	3000VDC min.
Isolation Capacitance	20pF typ.
Isolation Resistance	1 MΩ min.
Short Circuit Protection	Continuous, Automatic Restart
Short Circuit Input Current	30mA typ.
Operating Temperature Range (free air convection, with derating)	-25°C to +85°C
Storage Temperature Range	-50°C to +125°C
MTBF	1635 x 10 <sup>3</sup> hours min.

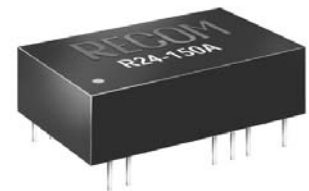

**RECOM**

## Derating Graph

(Ambient Temperature)

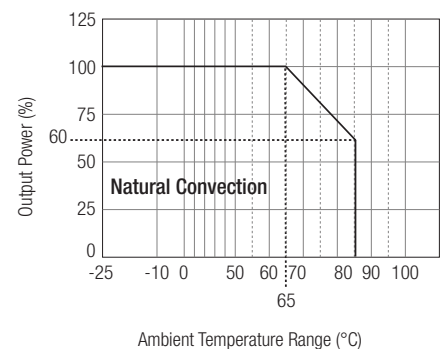

**Typical Applications**

**For remote control by variable resistor**

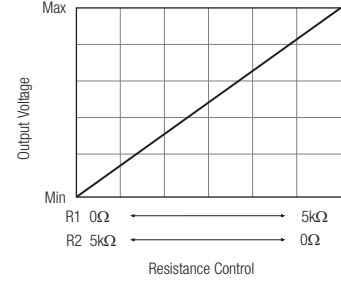
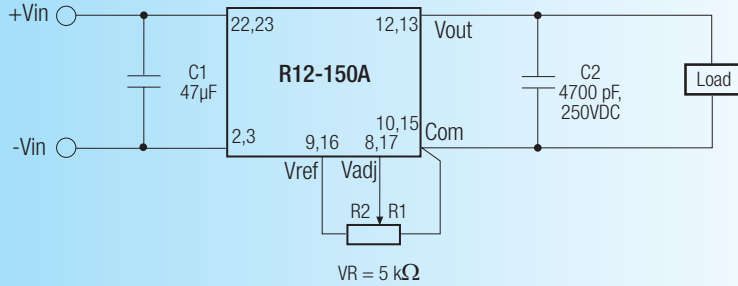

**For remote voltage control**

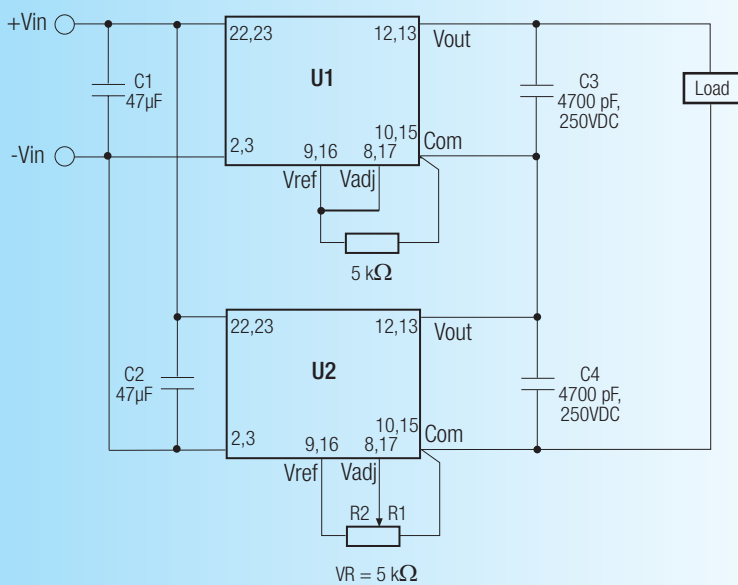
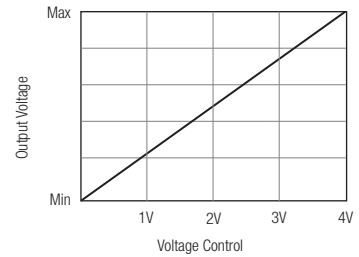
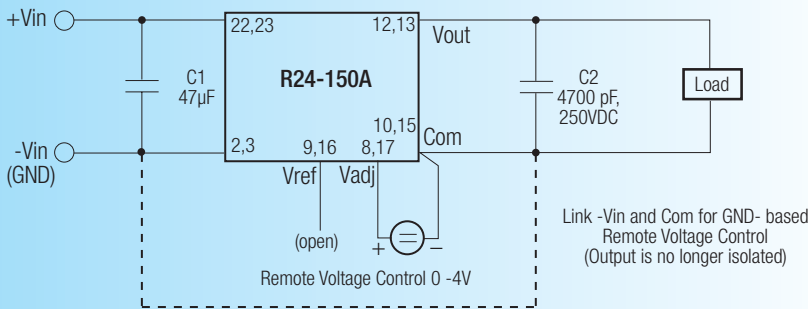

**Cascade Combinations**

U1	U2	Vout Range
Rxx-100A	Rxx-100A	190~270
Rxx-150A	Rxx-100A	230~345
Rxx-150A	Rxx-150A	305~420

Note: When cascaded, only one Rxx-A may be adjustable, the other must be fixed voltage.

## Typical Characteristics

R24-100A

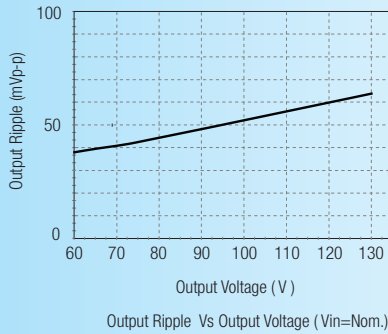

R24-100A

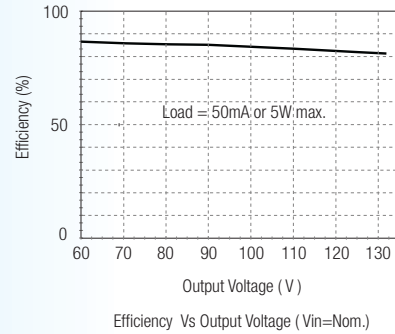

R24-100A

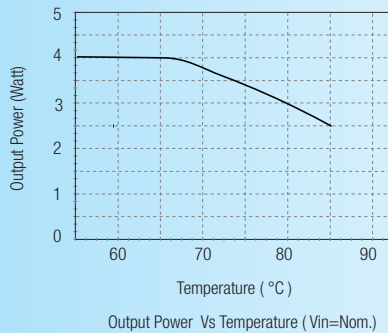

R24-100A

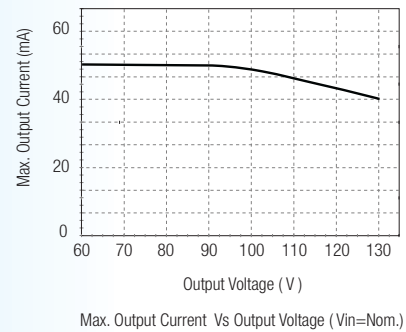

## Package Style and Pinning

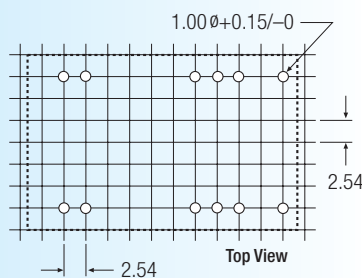
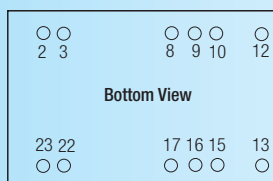
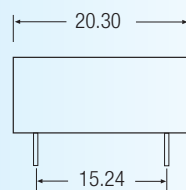
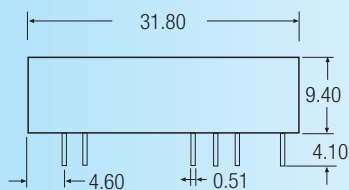

### Pin Connections

Pin #	Out
2,3	-Vin
8,17	Vadj
9,16	V ref
10,15	-Vout
12,13	+Vout
22,23	+Vin
XX.X	± 0.5 mm
XX.XX	± 0.25 mm