

To our customers,

Old Company Name in Catalogs and Other Documents

On April 1st, 2010, NEC Electronics Corporation merged with Renesas Technology Corporation, and Renesas Electronics Corporation took over all the business of both companies. Therefore, although the old company name remains in this document, it is a valid Renesas Electronics document. We appreciate your understanding.

Renesas Electronics website: <http://www.renesas.com>

April 1st, 2010
Renesas Electronics Corporation

Issued by: Renesas Electronics Corporation (<http://www.renesas.com>)

Send any inquiries to <http://www.renesas.com/inquiry>.

Notice

1. All information included in this document is current as of the date this document is issued. Such information, however, is subject to change without any prior notice. Before purchasing or using any Renesas Electronics products listed herein, please confirm the latest product information with a Renesas Electronics sales office. Also, please pay regular and careful attention to additional and different information to be disclosed by Renesas Electronics such as that disclosed through our website.
2. Renesas Electronics does not assume any liability for infringement of patents, copyrights, or other intellectual property rights of third parties by or arising from the use of Renesas Electronics products or technical information described in this document. No license, express, implied or otherwise, is granted hereby under any patents, copyrights or other intellectual property rights of Renesas Electronics or others.
3. You should not alter, modify, copy, or otherwise misappropriate any Renesas Electronics product, whether in whole or in part.
4. Descriptions of circuits, software and other related information in this document are provided only to illustrate the operation of semiconductor products and application examples. You are fully responsible for the incorporation of these circuits, software, and information in the design of your equipment. Renesas Electronics assumes no responsibility for any losses incurred by you or third parties arising from the use of these circuits, software, or information.
5. When exporting the products or technology described in this document, you should comply with the applicable export control laws and regulations and follow the procedures required by such laws and regulations. You should not use Renesas Electronics products or the technology described in this document for any purpose relating to military applications or use by the military, including but not limited to the development of weapons of mass destruction. Renesas Electronics products and technology may not be used for or incorporated into any products or systems whose manufacture, use, or sale is prohibited under any applicable domestic or foreign laws or regulations.
6. Renesas Electronics has used reasonable care in preparing the information included in this document, but Renesas Electronics does not warrant that such information is error free. Renesas Electronics assumes no liability whatsoever for any damages incurred by you resulting from errors in or omissions from the information included herein.
7. Renesas Electronics products are classified according to the following three quality grades: “Standard”, “High Quality”, and “Specific”. The recommended applications for each Renesas Electronics product depends on the product’s quality grade, as indicated below. You must check the quality grade of each Renesas Electronics product before using it in a particular application. You may not use any Renesas Electronics product for any application categorized as “Specific” without the prior written consent of Renesas Electronics. Further, you may not use any Renesas Electronics product for any application for which it is not intended without the prior written consent of Renesas Electronics. Renesas Electronics shall not be in any way liable for any damages or losses incurred by you or third parties arising from the use of any Renesas Electronics product for an application categorized as “Specific” or for which the product is not intended where you have failed to obtain the prior written consent of Renesas Electronics. The quality grade of each Renesas Electronics product is “Standard” unless otherwise expressly specified in a Renesas Electronics data sheets or data books, etc.
 - “Standard”: Computers; office equipment; communications equipment; test and measurement equipment; audio and visual equipment; home electronic appliances; machine tools; personal electronic equipment; and industrial robots.
 - “High Quality”: Transportation equipment (automobiles, trains, ships, etc.); traffic control systems; anti-disaster systems; anti-crime systems; safety equipment; and medical equipment not specifically designed for life support.
 - “Specific”: Aircraft; aerospace equipment; submersible repeaters; nuclear reactor control systems; medical equipment or systems for life support (e.g. artificial life support devices or systems), surgical implantations, or healthcare intervention (e.g. excision, etc.), and any other applications or purposes that pose a direct threat to human life.
8. You should use the Renesas Electronics products described in this document within the range specified by Renesas Electronics, especially with respect to the maximum rating, operating supply voltage range, movement power voltage range, heat radiation characteristics, installation and other product characteristics. Renesas Electronics shall have no liability for malfunctions or damages arising out of the use of Renesas Electronics products beyond such specified ranges.
9. Although Renesas Electronics endeavors to improve the quality and reliability of its products, semiconductor products have specific characteristics such as the occurrence of failure at a certain rate and malfunctions under certain use conditions. Further, Renesas Electronics products are not subject to radiation resistance design. Please be sure to implement safety measures to guard them against the possibility of physical injury, and injury or damage caused by fire in the event of the failure of a Renesas Electronics product, such as safety design for hardware and software including but not limited to redundancy, fire control and malfunction prevention, appropriate treatment for aging degradation or any other appropriate measures. Because the evaluation of microcomputer software alone is very difficult, please evaluate the safety of the final products or system manufactured by you.
10. Please contact a Renesas Electronics sales office for details as to environmental matters such as the environmental compatibility of each Renesas Electronics product. Please use Renesas Electronics products in compliance with all applicable laws and regulations that regulate the inclusion or use of controlled substances, including without limitation, the EU RoHS Directive. Renesas Electronics assumes no liability for damages or losses occurring as a result of your noncompliance with applicable laws and regulations.
11. This document may not be reproduced or duplicated, in any form, in whole or in part, without prior written consent of Renesas Electronics.
12. Please contact a Renesas Electronics sales office if you have any questions regarding the information contained in this document or Renesas Electronics products, or if you have any other inquiries.

(Note 1) “Renesas Electronics” as used in this document means Renesas Electronics Corporation and also includes its majority-owned subsidiaries.

(Note 2) “Renesas Electronics product(s)” means any product developed or manufactured by or for Renesas Electronics.

R0E521000EPB00

User's Manual

Emulation Probe for R8C/Tiny Series

Notes regarding these materials

1. This document is provided for reference purposes only so that Renesas customers may select the appropriate Renesas products for their use. Renesas neither makes warranties or representations with respect to the accuracy or completeness of the information contained in this document nor grants any license to any intellectual property rights or any other rights of Renesas or any third party with respect to the information in this document.
2. Renesas shall have no liability for damages or infringement of any intellectual property or other rights arising out of the use of any information in this document, including, but not limited to, product data, diagrams, charts, programs, algorithms, and application circuit examples.
3. You should not use the products or the technology described in this document for the purpose of military applications such as the development of weapons of mass destruction or for the purpose of any other military use. When exporting the products or technology described herein, you should follow the applicable export control laws and regulations, and procedures required by such laws and regulations.
4. All information included in this document such as product data, diagrams, charts, programs, algorithms, and application circuit examples, is current as of the date this document is issued. Such information, however, is subject to change without any prior notice. Before purchasing or using any Renesas products listed in this document, please confirm the latest product information with a Renesas sales office. Also, please pay regular and careful attention to additional and different information to be disclosed by Renesas such as that disclosed through our website. (<http://www.renesas.com>)
5. Renesas has used reasonable care in compiling the information included in this document, but Renesas assumes no liability whatsoever for any damages incurred as a result of errors or omissions in the information included in this document.
6. When using or otherwise relying on the information in this document, you should evaluate the information in light of the total system before deciding about the applicability of such information to the intended application. Renesas makes no representations, warranties or guarantees regarding the suitability of its products for any particular application and specifically disclaims any liability arising out of the application and use of the information in this document or Renesas products.
7. With the exception of products specified by Renesas as suitable for automobile applications, Renesas products are not designed, manufactured or tested for applications or otherwise in systems the failure or malfunction of which may cause a direct threat to human life or create a risk of human injury or which require especially high quality and reliability such as safety systems, or equipment or systems for transportation and traffic, healthcare, combustion control, aerospace and aeronautics, nuclear power, or undersea communication transmission. If you are considering the use of our products for such purposes, please contact a Renesas sales office beforehand. Renesas shall have no liability for damages arising out of the uses set forth above.
8. Notwithstanding the preceding paragraph, you should not use Renesas products for the purposes listed below:
 - (1) artificial life support devices or systems
 - (2) surgical implantations
 - (3) healthcare intervention (e.g., excision, administration of medication, etc.)
 - (4) any other purposes that pose a direct threat to human lifeRenesas shall have no liability for damages arising out of the uses set forth in the above and purchasers who elect to use Renesas products in any of the foregoing applications shall indemnify and hold harmless Renesas Technology Corp., its affiliated companies and their officers, directors, and employees against any and all damages arising out of such applications.
9. You should use the products described herein within the range specified by Renesas, especially with respect to the maximum rating, operating supply voltage range, movement power voltage range, heat radiation characteristics, installation and other product characteristics. Renesas shall have no liability for malfunctions or damages arising out of the use of Renesas products beyond such specified ranges.
10. Although Renesas endeavors to improve the quality and reliability of its products, IC products have specific characteristics such as the occurrence of failure at a certain rate and malfunctions under certain use conditions. Please be sure to implement safety measures to guard against the possibility of physical injury, and injury or damage caused by fire in the event of the failure of a Renesas product, such as safety design for hardware and software including but not limited to redundancy, fire control and malfunction prevention, appropriate treatment for aging degradation or any other applicable measures. Among others, since the evaluation of microcomputer software alone is very difficult, please evaluate the safety of the final products or system manufactured by you.
11. In case Renesas products listed in this document are detached from the products to which the Renesas products are attached or affixed, the risk of accident such as swallowing by infants and small children is very high. You should implement safety measures so that Renesas products may not be easily detached from your products. Renesas shall have no liability for damages arising out of such detachment.
12. This document may not be reproduced or duplicated, in any form, in whole or in part, without prior written approval from Renesas.
13. Please contact a Renesas sales office if you have any questions regarding the information contained in this document, Renesas semiconductor products, or if you have any other inquiries.

Preface

The R0E521000EPB00 is an emulation probe for the R8C/Tiny Series MCUs. The R0E521000EPB00 is used by connecting to the PC7501 emulator main unit.

This user's manual mainly describes specifications of the R0E521000EPB00 emulation probe and how to setup it. For details on the following products, which are used with the R0E521000EPB00, refer to each product's user's manual or online manual.

- Emulator main unit: PC7501
- Integrated development environment: High-performance Embedded Workshop
- Emulator debugger: M16C R8C PC7501 Emulator debugger

All the components of this product are shown in "Table 1.1 Package components" (page 13). If there is any question or doubt about this product, contact your local distributor.

The related manuals for using this product are listed below. You can download the latest manuals from the Renesas Tools homepage (<http://www.renesas.com/tools>).

Related manuals

Item	Manual
Emulator main unit	PC7501 User's Manual
Accessory tools	R0E521134CFG00 User's Manual
	R0E521174CSJ00 User's Manual
	R0E521174CDB00 User's Manual
	R0E521237CFK00 User's Manual
	R0E521258CFJ00 User's Manual
	R0E521276CFG00 User's Manual
	R0E5212BACFG00 User's Manual
	R0E5212BACFK00 User's Manual
	R0E5212DACFK00 User's Manual
R0E5212L4CFG00 User's Manual	
Integrated development environment	High-performance Embedded Workshop User's Manual
Emulator debugger	M16C R8C PC7501 Emulator debugger User's Manual
C compiler	C compiler package for R8C/Tiny, M16C/60, 30, Tiny, 20 and 10 Series C compiler User's Manual
Assembler	C compiler package for R8C/Tiny, M16C/60, 30, Tiny, 20 and 10 Series Assembler User's Manual

Important

Before using this product, be sure to read this user's manual carefully.

Keep this user's manual, and refer to this when you have questions about this product.

Emulator:

The emulator in this document refers to the following products that are manufactured by Renesas Technology Corp.:

- (1) PC7501 Emulator main unit
- (2) Emulation probe
- (3) Package converter board for connecting the user system

The emulator herein does not include the customer's user system and host machine.

Purpose of use of the emulator:

This emulator is a device to support the development of a system that uses the R8C/Tiny Series Renesas 16bit single-chip MCUs. It provides support for system development in both software and hardware.

Be sure to use this emulator correctly according to said purpose of use. Please avoid using this emulator for other than its intended purpose of use.

For those who use this emulator:

This emulator can only be used by those who have carefully read the user's manual and know how to use it.

Use of this emulator requires the basic knowledge of electric circuits, logical circuits, and MCUs.

When using the emulator:

- (1) This product is a development supporting unit for use in your program development and evaluation stages. In mass-producing your program you have finished developing, be sure to make a judgment on your own risk that it can be put to practical use by performing integration test, evaluation, or some experiment else.
- (2) In no event shall Renesas Solutions Corp. be liable for any consequence arising from the use of this product.
- (3) Renesas Solutions Corp. strives to renovate or provide a workaround for product malfunction at some charge or without charge. However, this does not necessarily mean that Renesas Solutions Corp. guarantees the renovation or the provision under any circumstances.
- (4) This product has been developed by assuming its use for program development and evaluation in laboratories. Therefore, it does not fall under the application of Electrical Appliance and Material Safety Law and protection against electromagnetic interference when used in Japan.
- (5) Renesas Solutions Corp. cannot predict all possible situations or possible cases of misuse where a potential danger exists. Therefore, the warnings written in this user's manual and the warning labels attached to this emulator do not necessarily cover all of such possible situations or cases. Please be sure to use this emulator correctly and safely on your own responsibility.
- (6) This product is not qualified under UL or other safety standards and IEC or other industry standards. This fact must be taken into account when taking this product from Japan to some other country.

Usage restrictions:

This emulator has been developed as a means of supporting system development by users. Therefore, do not use it as a device used for equipment-embedded applications. Also, do not use it for developing the systems or equipment used for the following purposes either:

- (1) Transportation and vehicular
- (2) Medical (equipment where human life is concerned)
- (3) Aerospace
- (4) Nuclear power control
- (5) Undersea repeater

If you are considering the use of this emulator for one of the above purposes, please be sure to consult your local distributor.

About product changes:

We are constantly making efforts to improve the design and performance of this emulator. Therefore, the specification or design of this emulator or its user's manual may be changed without prior notice.

About the rights:

- (1) We assume no responsibility for any damage or infringement on patent rights or any other rights arising from the use of any information, products or circuits presented in this user's manual.
- (2) The information or data in this user's manual does not implicitly or otherwise grant a license for patent rights or any other rights belonging to us or third parties.
- (3) This user's manual and this emulator are copyrighted, with all rights reserved by us. This user's manual may not be copied, duplicated or reproduced, in whole or part, without prior written consent of us.

About diagrams:

The diagrams in this user's manual may not all represent exactly the actual object.

Precautions for Safety

Definitions of Signal Words

In both the user's manual and on the product itself, several icons are used to insure proper handling of this product and also to prevent injuries to you or other persons, or damage to your properties.

This chapter describes the precautions which should be taken in order to use this product safely and properly. Be sure to read this chapter before using this product.



This symbol represents a warning about safety. It is used to arouse caution about a potential danger that will possibly inflict an injury on persons. To avoid a possible injury or death, please be sure to observe the safety message that follows this symbol.



DANGER indicates an imminently dangerous situation that will cause death or heavy wound unless it is avoided. However, there are no instances of such danger for the product presented in this user's manual.



WARNING indicates a potentially dangerous situation that will cause death or heavy wound unless it is avoided.



CAUTION indicates a potentially dangerous situation that will cause a slight injury or a medium-degree injury unless it is avoided.

CAUTION

CAUTION with no safety warning symbols attached indicates a potentially dangerous situation that will cause property damage unless it is avoided.

IMPORTANT

This is used in operation procedures or explanatory descriptions to convey exceptional conditions or cautions to the user.

In addition to the five above, the following are also used as appropriate.

△ means WARNING or CAUTION.

Example:



CAUTION AGAINST AN ELECTRIC SHOCK

⊘ means PROHIBITION.

Example:



DISASSEMBLY PROHIBITED

● means A FORCIBLE ACTION.

Example:



UNPLUG THE POWER CABLE FROM THE RECEPTACLE.

⚠ WARNING

Warnings for AC Power Supply:



- If the attached AC power cable does not fit the receptacle, do not alter the AC power cable and do not plug it forcibly. Failure to comply may cause electric shock and/or fire.

- Use an AC power cable which complies with the safety standard of the country.
- Do not touch the plug of the AC power cable when your hands are wet. This may cause electric shock.
- This product is connected signal ground with frame ground. If your developing product is transformless (not having isolation transformer of AC power), this may cause electric shock. Also, this may give an unreparable damage to this product and your developing one.
While developing, connect AC power of the product to commercial power through isolation transformer in order to avoid these dangers.
- If other equipment is connected to the same branch circuit, care should be taken not to overload the circuit.



- When installing this equipment, insure that a reliable ground connection is maintained.



- If you smell a strange odor, hear an unusual sound, or see smoke coming from this product, then disconnect power immediately by unplugging the AC power cable from the outlet.
Do not use this as it is because of the danger of electric shock and/or fire. In this case, contact your local distributor.
- Before setting up this emulator and connecting it to other devices, turn off power or remove a power cable to prevent injury or product damage.

Warnings to Be Taken for This Product:



- Do not disassemble or modify this product. Personal injury due to electric shock may occur if this product is disassembled and modified. Disassembling and modifying the product will void your warranty.
- Make sure nothing falls into the cooling fan on the top panel, especially liquids, metal objects, or anything combustible.

Warning for Installation:



- Do not set this product in water or areas of high humidity. Make sure that the product does not get wet. Spilling water or some other liquid into the product may cause unreparable damage.

Warning for Use Environment:



- This equipment is to be used in an environment with a maximum ambient temperature of 35°C. Care should be taken that this temperature is not exceeded.

 **CAUTION****Cautions to Be Taken for Turning On the Power:**

- Turn ON/OFF the power of the emulator and user system as simultaneously as possible.
Do not leave only the user system powered on, because of leakage current the internal circuits may be damaged.
- When turning on the power again after shutting off the power, wait about 10 seconds.

Cautions to Be Taken for Handling This Product:

- Use caution when handling the main unit. Be careful not to apply a mechanical shock.
- Do not touch the connector pins of the emulator main unit and the target MCU connector pins directly. Static electricity may damage the internal circuits.
- Do not pull this emulator by the communications interface cable or the cable for connecting the user system. And, excessive flexing or force may break conductors.
- Do not flex the flexible cable for connecting to the emulator main unit and emulation probe excessively. The cable may cause a break.
- Do not use inch-size screws for this equipment. The screws used in this equipment are all ISO (meter-size) type screws. When replacing screws, use same type screws as equipped before.

Caution to Be Taken for System Malfunctions:

- If the emulator malfunctions because of interference like external noise, do the following to remedy the trouble.
 - (1) Press the RESET button on the emulator front panel.
 - (2) If normal operation is not restored after step (1), shut OFF the emulator once and then reactivate it.

Contents

	Page
Preface.....	3
Important.....	4
Precautions for Safety	6
Contents.....	9
User Registration	11
Terminology	12
1. Outline.....	13
1.1 Package Components	13
1.2 Other Tool Products Required for Development.....	14
1.3 System Configuration	15
1.3.1 System Configuration.....	15
1.3.2 Names and Functions of the PC7501 Upper Panel LEDs	16
1.4 Specifications	18
1.5 Operating Environment	19
2. Setup.....	20
2.1 Flowchart of Starting Up the Emulator	20
2.2 Installing the M16C R8C PC7501 Emulator Debugger	21
2.3 Connecting to the Host Machine	22
2.4 Connecting to the PC7501	23
2.5 Power Supply for the Emulator	24
2.6 Turning ON the Power.....	25
2.6.1 Checking the Connections of the Emulator System	25
2.6.2 Power Supply to the User System	25
2.6.3 Turning ON/OFF the Power	25
2.6.4 LED Display When the Emulator Starts Up Normally	25
2.7 Downloading Firmware.....	26
2.7.1 When It is Necessary to Download Firmware	26
2.7.2 Downloading Firmware in Maintenance Mode.....	26
2.8 Self-check.....	27
2.8.1 Self-check Procedure.....	27
2.8.2 If an Error is Detected in the Self-check	28
2.9 Connecting to the User System	29
2.9.1 Connecting to a 32-pin 0.8mm pitch LQFP foot pattern	30
2.9.2 Connecting to a 20-pin 0.65mm pitch LSSOP Foot Pattern	31
2.9.3 Connecting to a 20-pin 1.778mm pitch SDIP Foot Pattern.....	32
2.9.4 Connecting to a 48-pin 0.5mm pitch LQFP Foot Pattern.....	33
2.9.5 Connecting to a 52-pin 0.65mm pitch LQFP Foot Pattern.....	34
2.9.6 Connecting to a 64-pin 0.8mm pitch LQFP Foot Pattern.....	35
2.9.7 Connecting to a 64-pin 0.5mm pitch LQFP Foot Pattern.....	36
2.9.8 Connecting to an 80-pin 0.5mm pitch LQFP Foot Pattern.....	37
2.10 Setting Switches.....	38
2.10.1 Setting the Jumper on the Emulation Probe R0E521000EPBM0.....	38
2.10.2 Setting the POWER Selection Jumper	39
2.10.3 Selecting Clock Supply	40
2.10.4 A/D Conversion Bypass Capacitors.....	44

	Page
3. Usage (Emulator Debugger).....	45
3.1 Starting Up the Emulator Debugger	45
3.1.1 INIT Dialog Box	45
3.1.2 MCU Setting Dialog Box	49
3.1.3 Checking Connections of the Emulator System	50
3.2 Downloading the Program.....	51
3.3 Program Execution	52
3.4 Hardware Breakpoint.....	55
3.5 Trace Window	60
3.6 RAM Monitor Window.....	64
4. Hardware Specifications	66
4.1 Target MCU Specifications.....	66
4.2 Differences between the Actual MCU and Emulator.....	67
4.3 Connection Diagrams.....	69
4.3.1 Connection diagram of R0E521000EPB00.....	69
4.3.2 Connection diagram of R0E5212BACFG00, R0E5212BACFK00 and R0E5212DACFK00.....	70
4.4 External Dimensions	71
4.4.1 External Dimensions of the Emulation Probe	71
4.4.2 External Dimensions of the Converter Board R0E521134CFG00.....	72
4.4.3 External Dimensions of the Converter Board R0E521174CSJ00	72
4.4.4 External Dimensions of the Converter Board R0E521174CDB00.....	73
4.4.5 External Dimensions of the Converter Board R0E521237CFK00	73
4.4.6 External Dimensions of the Converter Board R0E521258CFJ00.....	74
4.4.7 External Dimensions of the Converter Board R0E521276CFG00.....	74
4.4.8 External Dimensions of the Converter Board R0E5212BACFG00.....	75
4.4.9 External Dimensions of the Converter Board R0E5212BACFK00	75
4.4.10 External Dimensions of the Converter Board R0E5212DACFK00	76
4.4.11 External Dimensions of the Converter Board R0E5212L4CFG00.....	766
4.5 Notes on Using This Product.....	77
5. Troubleshooting	80
5.1 Flowchart to Remedy the Troubles	80
5.2 When the Emulator Debugger Does Not Start Up Properly.....	81
5.2.1 When the LEDs of the PC7501 Do Not Display Normally	81
5.2.2 MCU Setting Dialog Box Does Not Appear at Debugger Startup.....	82
5.2.3 Errors Occur at Debugger Startup	83
5.3 How to Request a Support	83
6. Maintenance and Guarantee	84
6.1 User Registration.....	84
6.2 Maintenance	84
6.3 Guarantee	84
6.4 Repair Provisions	84
6.5 How to Make Request for Repair	85

User Registration

Customer Registration Sheet is included with this manual, fill it in and FAX or email it to your local distributor. If you register it by email, you can use a text format for user registration created when installing the software in the following folder. Your registered information is used for only after-sale services, and not for any other purposes. Without user registration, you will not be able to receive maintenance services such as a notification of field changes or trouble information. So be sure to carry out the user registration.

For more information about user registration, please contact your local distributor.

Text format for user registration

C:\Program Files\Renesas\Hew\Support

Terminology

Some specific words used in this user's manual are defined as follows:

Emulator system

This means an emulator system built around the PC7501 emulator. The PC7501 emulator system is configured with an emulator main unit, emulation probe, host machine and the integrated development environment High-performance Embedded Workshop.

Emulator main unit (Hereafter PC7501)

This means an emulator main unit for M16C Family.

Emulation probe

This means the emulation probe (this product) for the R8C/Tiny Series MCUs.

Integrated development environment High-performance Embedded Workshop

This tool provides powerful support for the development of embedded applications for Renesas microcomputers. It has an emulator debugger function allowing for the emulator to be controlled from the host machine via an interface. Furthermore, it permits a range of operations from editing a project to building and debugging it to be performed within the same application. What's more, it supports version management.

Emulator debugger

This means a software tool starting up from the High-performance Embedded Workshop to control the PC7501 and this product and enable debugging. Please be sure to use this product with the M16C R8C PC7501 Emulator debugger.

Firmware

Program that analyzes contents of communication with the emulator debugger and controls the PC7501 hardware. This program is installed in the flash memory in the emulator main unit. This program is downloadable from the emulator debugger to upgrade the firmware or to support other MCUs.

Host machine

This means a personal computer used to control the PC7501 and emulation probe.

Software break

A software break is a function to break the program before the system executes an instruction at the specified address. The instruction at the preset address will not be executed.

Hardware break

A hardware break is a function to break the program when the system detects a write/read of data to/from memory or a leading/trailing edge of the signal entered from the external trace cable. The former break function is called address break; and the latter break function is called trigger break. While the instruction at the address where the software break is set is not executed, a hardware break is performed after the specified instruction is executed.

Target MCU

This means the MCU you are going to debug.

User system

This means a user's application system using the microcomputer to be debugged.

User program

This means the program you are going to debug.

Evaluation MCU

This means the MCU mounted on the emulation probe which is operated in the specific mode for tools.

#

In this user's manual, this symbol is used to show active Low. (e.g. RESET#: Reset signal)

1. Outline

This chapter describes the package components, the system configuration, the specifications of the emulator functions and the operating environment.

1.1 Package Components

The R0E521000EPB00 package consists of the following items. When unpacking it, check to see if your R0E521000EPB00 contains all of these items.

Table 1.1 Package components

Item	Quantity
R0E521000EPB00 emulation probe	1
OSC-3 (20MHz) oscillator circuit board	1
OSC-2 oscillator circuit bare board	1
R0E521000EPB00 Release Notes (English)	1
R0E521000EPB00 Release Notes (Japanese)	1
H/W Tool Customer Registration Sheet (English)	1
H/W Tool Customer Registration Sheet (Japanese)	1
Repair Request Sheet (English)	1
Repair Request Sheet (Japanese)	1
R0E521000EPB00 User's Manual (this manual)	1
R0E521000EPB00 User's Manual (Japanese)	1

* Please keep the R0E521000EPB00's packing box and cushion material in your place for reuse at a later time when sending your product for repair or other purposes. Always use these packing box and cushion material when transporting this product.

* If there is any question or doubt about the packaged product, contact your local distributor.

1.2 Other Tool Products Required for Development

To bring forward programs development on the R8C/Tiny Series MCUs, the products listed below are necessary in addition to those contained package above. Get them separately.

Table 1.2 Other tool products required for development

Product	Product name	Notes	
Emulator main unit	PC7501	Required (Use of the emulator debugger is bundled with the emulator main unit.)	
Emulator debugger	M16C R8C PC7501 Emulator Debugger		
Converter board	For 32-pin 0.8mm pitch LQFP (PLQP0032GB-A, formerly 32P6U-A)	R0E521134CFG00 (included with the R0E521134EPB00) R0E521276CFG00 (included with the R0E521276EPB00) R0E5212L4CFG00 (included with the R0E5212L4EPB00)	Required according to the foot pattern of the user system (see "2.9 Connecting the User System" on page 29)
	For 20-pin 0.65mm pitch LSSOP (PLSP0020JB-A, formerly 20P2F-A)	R0E521174CSJ00 (included with the R0E521174 EPB00)	
	For 20-pin 1.778mm pitch SDIP (PRDP0020BA-A, formerly 20P4B)	R0E521174CDB00 (included with the R0E521174 EPB10)	
	For 48-pin 0.5mm pitch LQFP (PLQP0048KB-A, formerly 48P6Q-A)	R0E521237CFK00 (included with the R0E521237 EPB00)	
	For 52-pin 0.65mm pitch LQFP (PLQP0052JA-A, formerly 52P6A-A)	R0E521258CFJ00 (included with the R0E521258 EPB00)	
	For 64-pin 0.8mm pitch LQFP (PLQP0064GA-A, formerly 64P6U-A)	R0E5212BACFG00 (included with the R0E5212BAEPB00)	
	For 64-pin 0.5mm pitch LQFP (PLQP0064KB-A, formerly 64P6Q-A)	R0E5212BACFK00 (included with the R0E5212BAEPB10)	
	For 80-pin 0.5mm pitch LQFP (PLQP0080KB-A, formerly 80P6Q-A)	R0E5212DACFK00 (included with the R0E5212DAEPB00)	

* To purchase these products, contact your local distributor.

1.3 System Configuration

1.3.1 System Configuration

Figure 1.1 shows a configuration of the R0E521000EPB00 system.

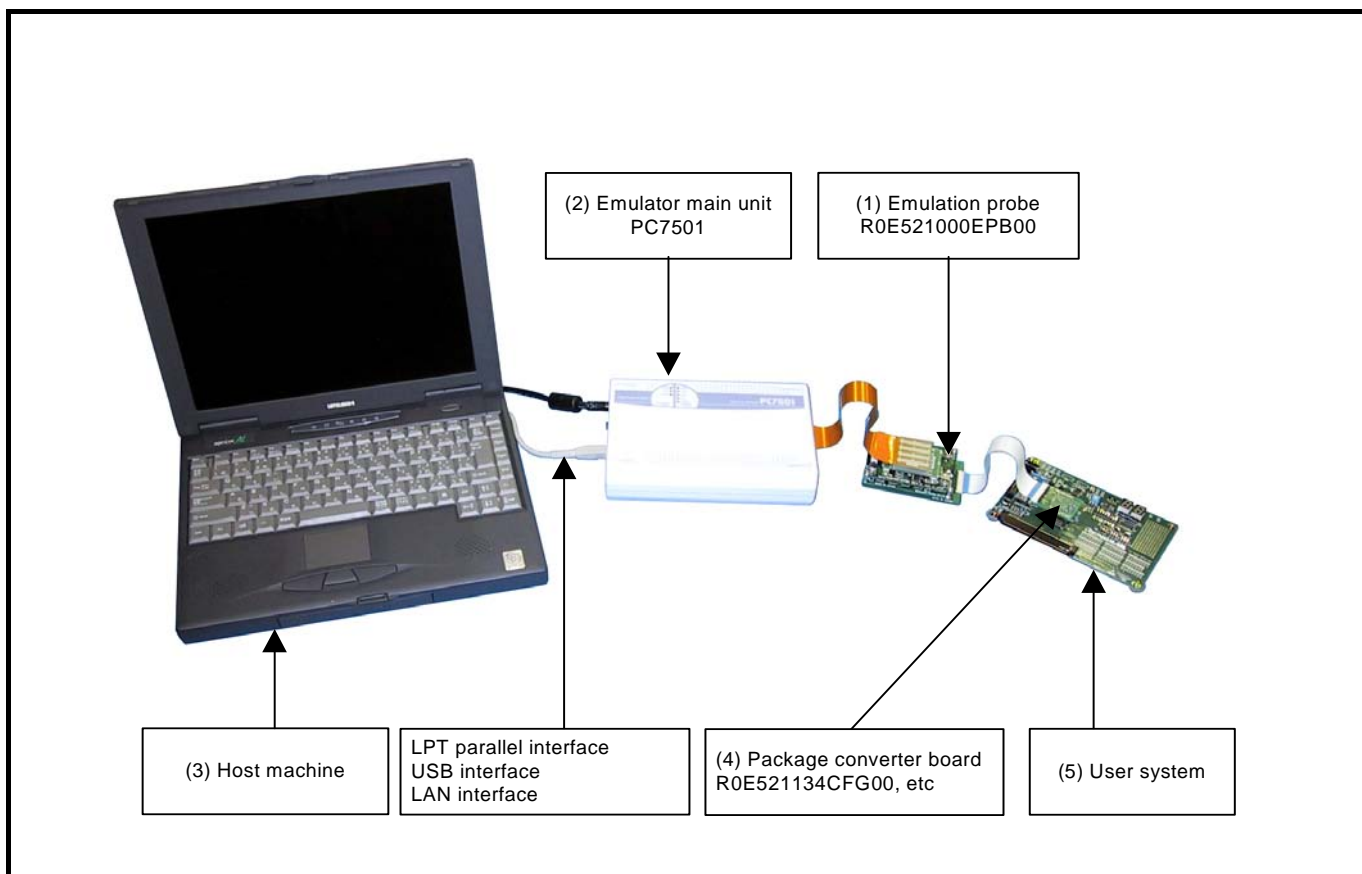

Figure 1.1 System configuration

- (1) Emulation probe R0E521000EPB00 (this product)
This emulation probe contains an evaluation MCU.
For your target MCU, set packages that consist of the converter board for connecting the user system are also available.
- (2) Emulator main unit PC7501
The emulator main unit for the M16C Family to be used with this product.
- (3) Host machine
A personal computer to control the emulator.
- (4) Package converter board such as R0E521134CFG00
This is a package converter board for connecting to the MCU foot pattern on the user system. For details, refer to "2.9 Connecting the User System" (page 29)
- (5) User system
This is your application system.
This emulator cannot supply the power to the user system. Therefore design your system so that the user system is powered separately.

1.3.2 Names and Functions of the PC7501 Upper Panel LEDs

Figure 1.2 shows the names of the LEDs on the upper panel of the emulator.

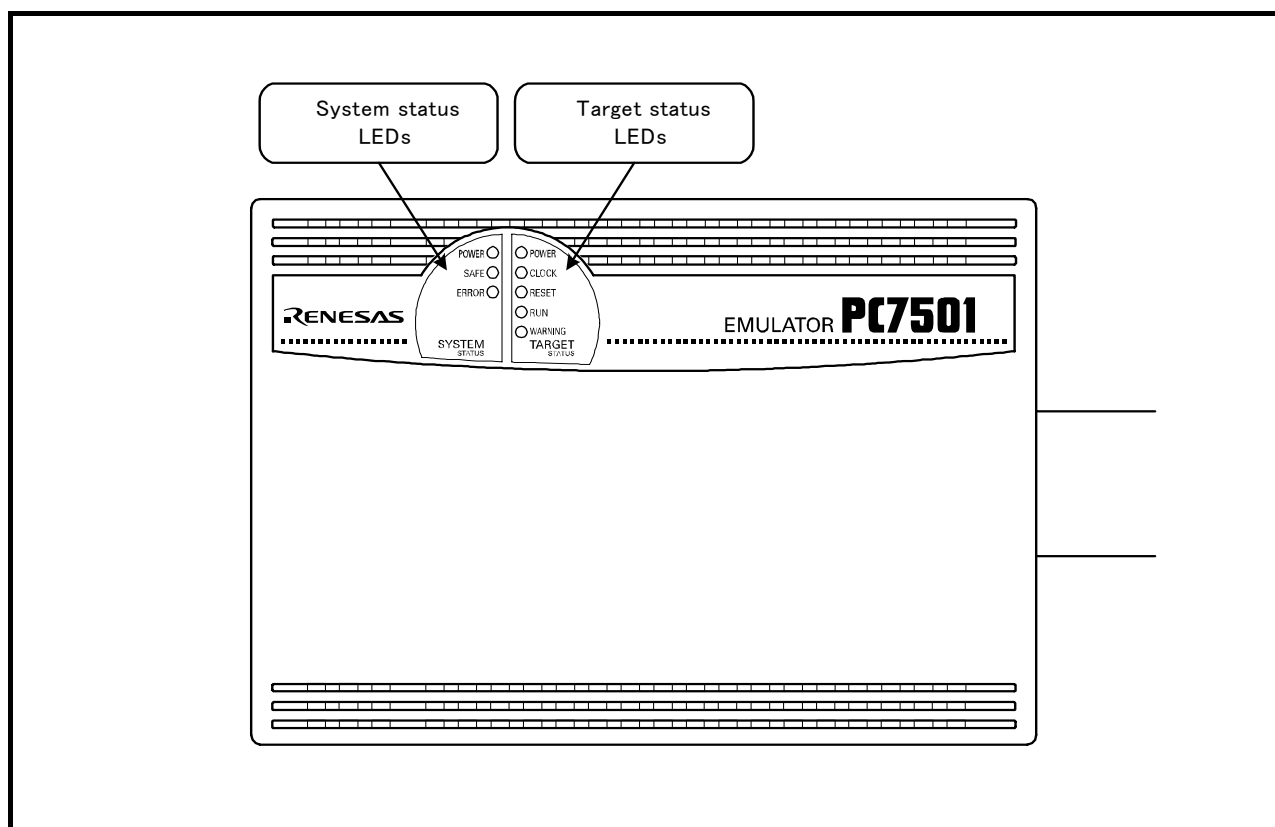

Figure 1.2 Names of the LEDs on the upper panel of the PC7501

(1) System Status LEDs

The system status LEDs indicate the emulator PC7501's power supply, firmware operating status, etc. Table 1.3 lists the definition of each system status LED.

Table 1.3 Definitions of the system status LEDs

Name	Status	Meaning
POWER	ON	Emulator system power supply is turned ON.
	OFF	Emulator system power supply is turned OFF.
SAFE	ON	Emulator system is operating normally.
	Flashing	1. The self-check is being executed. 2. Downloaded firmware is being written into memory. 3. If the ERROR LED is flashing on at the same time or alternately, it indicates that the self-check error occurred.
	OFF	PC7501 system is not operating normally (system status error).
ERROR	ON	PC7501 system is not operating normally (system status error).
	Flashing	1. Firmware is being downloaded. 2. If the SAFE LED is flashing at the same time or alternately, it indicates that the self-check error occurred.
	OFF	Emulator system is operating normally.

(2) Target Status LEDs

The target status LEDs indicate operating status of the target MCU and power supply of the user system. Table 1.4 lists the definition of each target status LED.

Table 1.4 Definitions of the target status LEDs

Name	Status	Meaning
POWER	ON	Power is supplied to the target MCU.
	OFF	Power is not supplied to the target MCU.
CLOCK	ON	Target MCU clock is oscillating.
	OFF	Target MCU clock is not oscillating.
RESET	ON	Target MCU is being reset, or reset signal of the user system is held low.
	OFF	Target MCU is not being reset.
RUN	ON	User program is being executed.
	OFF	User program has been halted.
WARNING	ON	Address 00000h or 00001h is read out wrongly.
	OFF	Address 00000h or 00001h is not read out.

1.4 Specifications

Tables 1.5 and Table 1.6 list the specifications of the R0E521000EPB00.

Table 1.5 R0E521000EPB00 specifications (1)

Applicable MCUs	R8C/Tiny Series MCUs	
Maximum ROM/RAM capacity	ROM capacity: 112KB (04000h to 1FFFFh) + 4KB (02000h to 02FFFh) RAM capacity: 8KB (00300h to 012FFh, 03000h to 03FFFh)	
Usable mode	Single-chip mode	
Maximum operating frequency	20MHz at 3.0--5.5V 10MHz at 2.7--5.5V 5MHz at 2.2--5.5V	
Applicable power supply	User system connected	2.2--5.5V* ¹ (depends on the Power selection jumper)
	User system not connected	5.0V (supplied from the emulator)
Basic debugging functions	<ul style="list-style-type: none"> - Download - Software break (max. 64 points) - Program execution/stop (allows free-run execution supporting software breaks) - Memory reference/setting (reference/setting C-variables, run-time execution) - Register reference/setting - Disassemble display - C-level debugging, etc. 	
Real-time trace function	<ul style="list-style-type: none"> - 256K-cycle bus information recordable (Bus, external trigger, time stamp) - 5 trace modes supported (Break/Before/About/After/Full) - Can be recorded ON/OFF by events 	
Real-time RAM monitor function	<ul style="list-style-type: none"> - 4,096 bytes (256 bytes x16) - Data/last access result 	
Hardware break function	8 points (Execution address, bus detection, interrupt, external trigger signal)	
Execution time measurement function	Time between program start and stop Maximum/minimum/average execution time and pass count of specified four zones. Count clock: Equal to MCU Clock or 16MHz	
C0 coverage	8,192KB (256KB x 32 blocks)	
External trigger input/event output* ²	External trigger input (MCU-dependent-voltage CMOS level x8) or event output (break x1, event x7)	
Host machine interface	<ul style="list-style-type: none"> - LPT parallel (ECP, EEP, Byte/compatibility and Nibble/compatibility modes) - USB (USB 1.1, full-speed)*³ - LAN (10BASE-T) 	
Power supply to emulator	Supplied from included AC adapter (power supply voltage: 100--240V, 50/60Hz)	

*1: If using this product when the voltage is less than 2.7V, the JP1 of the R0E521000EPBM0 should be set to EXT.

For details, refer to "2.10.2 Setting the POWER Selection Jumper" (page 39).

*2: When the POWER selection jumper is switched to the EXT side, the upper limit of the external trigger input level (VI) is 3.6 [V]. Similarly, the upper limit of the event output level (Vo) is 3.3 [V].

*3: Can be connected to the USB2.0 port of the host machine.

With the USB interface of this product, not all hardware (such as host machine, USB devices, USB hub) combination will work and guaranteed.

Table 1.6 R0E521000EPB00 specifications (2)

Connection with the user system (For details, refer to 2.9)	For 32-pin 0.8mm pitch LQFP (PLQP0032GB-A, formerly 32P6U-A)	R0E521134CFG00 (included with the R0E521134EPB00) R0E521276CFG00 (included with the R0E521276EPB00) R0E5212L4CFG00 (included with the R0E5212L4EPB00)
	For 20-pin 0.65mm pitch LSSOP (PLSP0020JB-A, formerly 20P2F-A)	R0E521174CSJ00 (included with the R0E521174EPB00)
	For 20-pin 1.778mm pitch SDIP (PRDP0020BA-A, formerly 20P4B)	R0E521174CDB00 (included with the R0E521174EPB10)
	For 48-pin 0.5mm pitch LQFP (PLQP0048KB-A, formerly 48P6Q-A)	R0E521237CFK00 (included with the R0E521237EPB00)
	For 52-pin 0.65mm pitch LQFP (PLQP0052JA-A, formerly 52P6A-A)	R0E521258CFJ00 (included with the R0E521258EPB00)
	For 64-pin 0.8mm pitch LQFP (PLQP0064GA-A, formerly 64P6U-A)	R0E5212BACFG00 (included with the R0E5212BAEPB00)
	For 64-pin 0.5mm pitch LQFP (PLQP0064KB-A, formerly 64P6Q-A)	R0E5212BACFK00 (included with the R0E5212BAEPB10)
	For 80-pin 0.5mm pitch LQFP (PLQP0080KB-A, formerly 80P6Q-A)	R0E5212DACFK00 (included with the R0E5212DAEPB00)

1.5 Operating Environment

Be sure to use this emulator with the operating environmental of the emulator and host machine listed in Tables 1.6 and 1.7.

Table 1.7 Operating environmental conditions

Item	Description
Operating temperature	5 to 35°C (no dew)
Storage temperature	-10 to 60°C (no dew)

Table 1.8 Operating environment of the host machine

Item	Description
Host machine	IBM PC/AT compatibles
OS	Windows XP * Windows 2000
CPU	Pentium III 600 MHz or more recommended
Memory	128 MB or greater (more than 10 times the file size of the load module) recommended
Hard disk	Emulator debugger installation needs 100 MB or more free space. (In view of swap area, keep another free space which is more than twice the memory capacity. (More than four times the memory capacity recommended.))
Display resolution	1024 × 768 or greater recommended
Pointing device such as mouse	Mouse or any other pointing device usable with the above OS that can be connected to the main body of the host machine.
CD drive	Needed to install the emulator debugger or refer to the user's manual

* Windows is either registered trademarks or trademarks of Microsoft Corporation in the United States and other countries.

2. Setup

This chapter describes the preparation for using this product, the procedure for starting up the emulator and how to change settings.

2.1 Flowchart of Starting Up the Emulator

The procedure for starting up the emulator is shown in Figure 2.1. For details, refer to each section hereafter. And, when the emulator does not start up normally, refer to “5. Troubleshooting” (page 80).

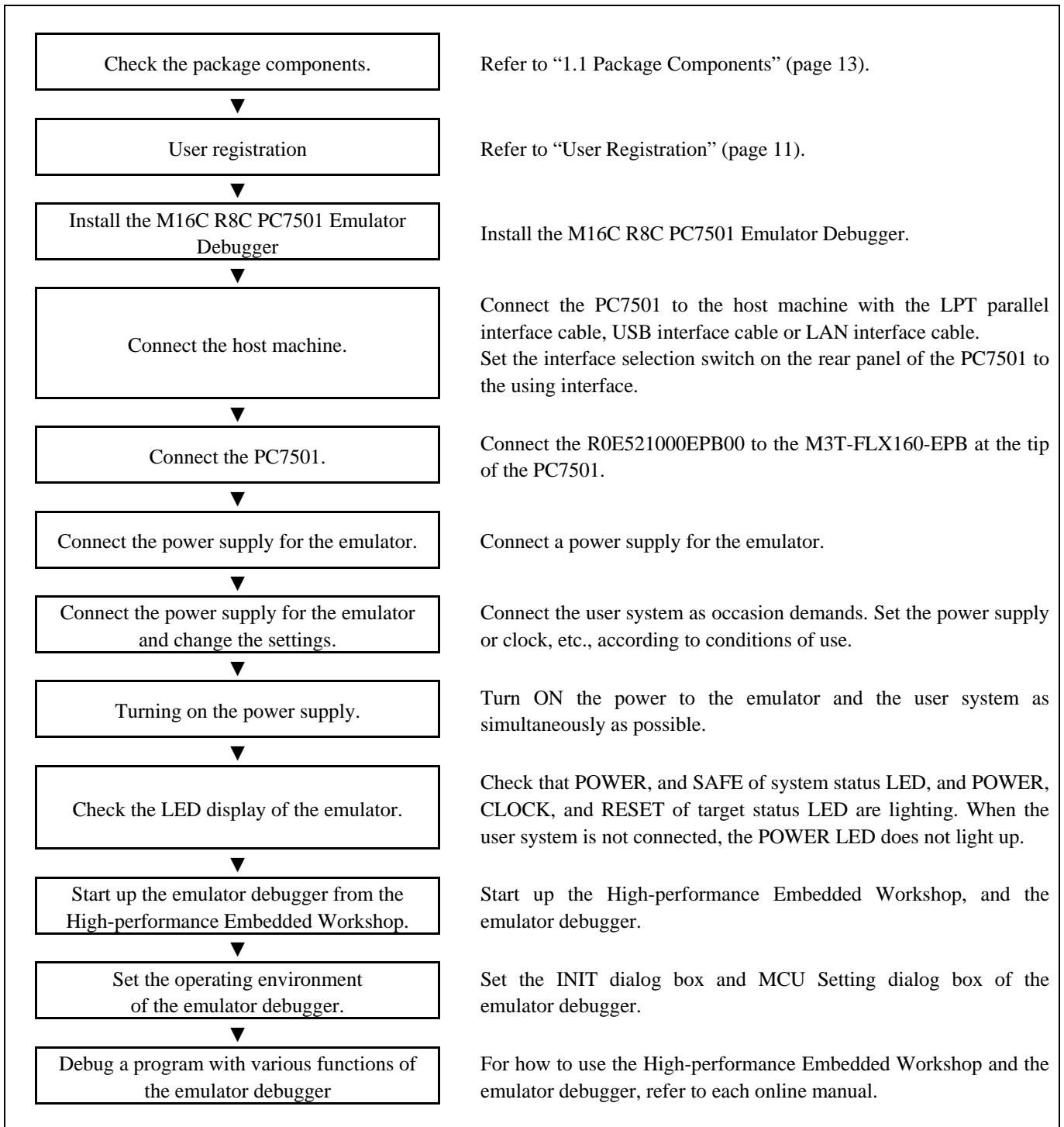

Figure 2.1 Flowchart of starting up the emulator

2.2 Installing the M16C R8C PC7501 Emulator Debugger

If the OS used in your host machine is Windows XP or 2000, this installation must be executed by a user with administrator rights. Be aware that users without administrator rights cannot complete the installation.

Install the emulator debugger (M16C R8C PC7501 Emulator Debugger) following the procedure described below.

(1) Downloading the emulator debugger

Download the latest emulator debugger from the URL below.

http://download.renesas.com/eng/mpumcu/upgrades/in_circuit_emulators/pc7501/index.html

(2) Launching the installer

Start the "setup.exe" program.

(3) Entering the user information

In the "user information" dialog box, enter the user information (contractor, section, contact address, and host machine).

The supplied information will be turned into a format by which user registration will be provided by e-mail.

(4) Completing the installation

A dialog box will be displayed indicating that setup has been completed. It means that the installation you made is completed.

2.3 Connecting to the Host Machine

When connecting the emulator PC7501 to a host machine, you can choose your desired interface from LPT parallel interface, USB interface and LAN interface. Use the interface selection switch on the emulator PC7501's rear panel to specify your desired interface. Figure 2.2 shows the outline to connect each interface cable.

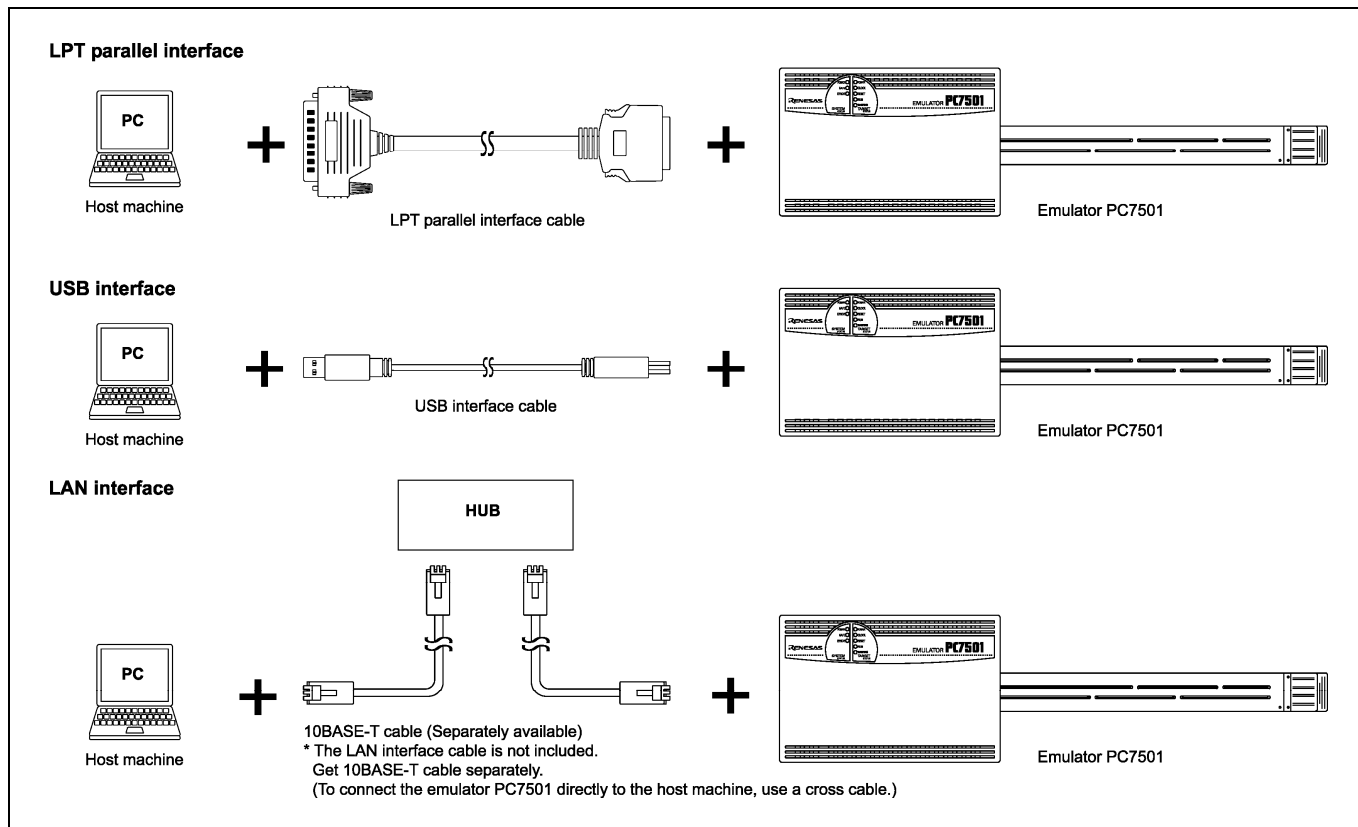

Figure 2.2 Outline for interface cable connections

2.4 Connecting to the PC7501

Figure 2.3 shows how to connect the emulation probe to the PC7501.

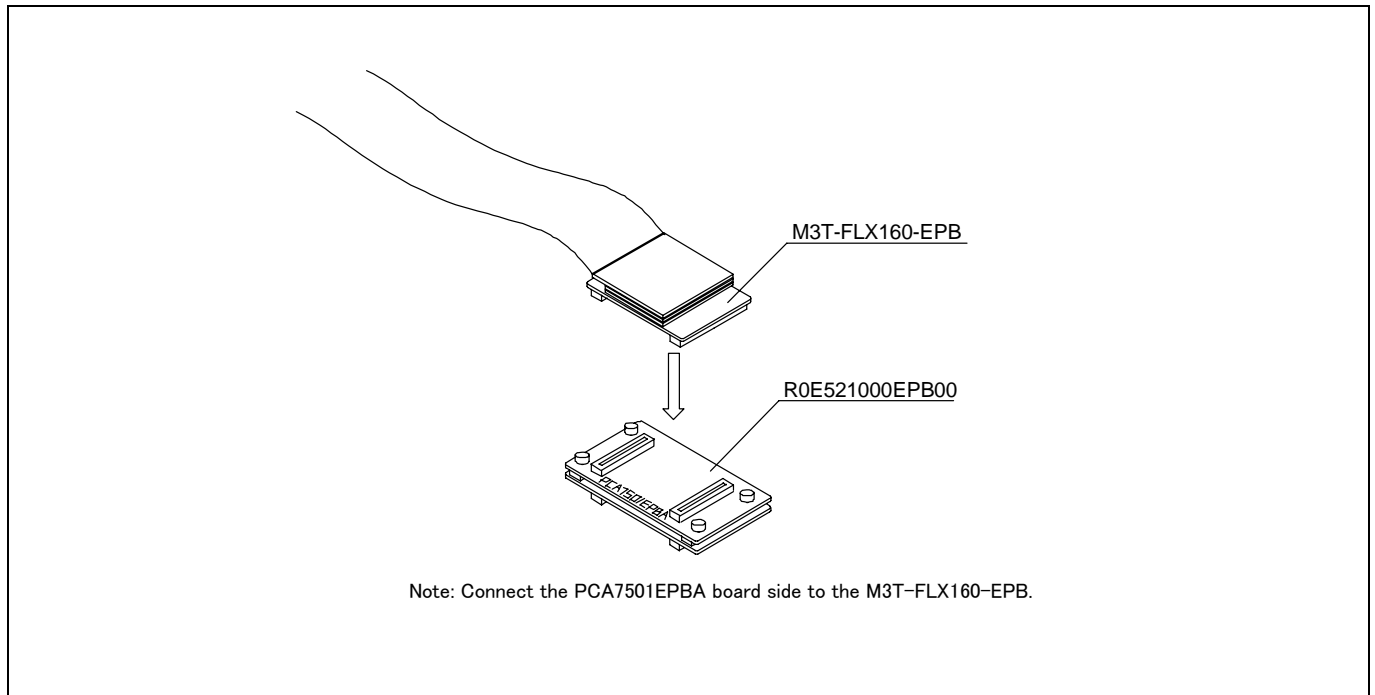

Figure 2.3 Connecting the emulation probe to the PC7501

⚠ CAUTION

Caution for Connecting to the PC7501:



- Always shut OFF power before connecting the emulation probe. Otherwise, internal circuits may be damaged.

IMPORTANT

Notes on Connecting to the PC7501:

- When connecting the emulation probe, be sure to hold the both sides of the emulation probe horizontally and insert it directly.
- The connectors of the R0E521000EPB00 are guaranteed for only 50 insertion/removal iterations.

2.5 Power Supply for the Emulator

The power is supplied from AC adapter to the PC7501. Here following explains how to connect the AC adapter.

- (1) Turn OFF the power to the PC7501.
- (2) Connect the DC cable of AC adapter to the PC7501.
- (3) Connect the AC power cable to the AC adapter.
- (4) Connect the AC power cable to the receptacle.

CAUTION

Cautions for AC Adapter:



- Use only the AC adapter included in PC7501 package.
- The included AC adapter is for PC7501. Do not use it for other product.
- Before installing this equipment or connecting it to other equipment, disconnect the AC power cable from its outlet to prevent injury or accident.
- The DC plug on the included AC adapter has the below polarity.

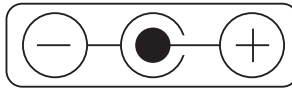

- The included AC adapter has no power supply switch. The AC adapter is always active while connecting the AC power cable. Check if the power is supplied by the LED of AC adapter.

2.6 Turning ON the Power

2.6.1 Checking the Connections of the Emulator System

Before turning the power ON, check the connection of the interface cable with host machine, PC7501, emulation probe, and user system.

2.6.2 Power Supply to the User System

This emulator cannot supply the power to the user system. Therefore design your system so that the user system is powered separately.

The voltage of the user system should be $2.7V \leq VCC \leq 5.5V$ when the POWER selection jumper is set to the INT POWER side. Do not change the voltage of the user system after turning on the power. To change the power supply voltage of the user system, and the voltage of the user system is 2.2V to 2.7V, set the POWER selection jumper to the EXT POWER side. For details about the POWER selection jumper, refer to “2.10.1 Setting the Jumper on the Emulation Probe R0E521000EPBM0” (page 38).

When the POWER selection jumper is set to the EXT POWER side, this product consumes max. 500 mA of electrical current from the user system. Please consider the capacity of the power supply of the user system.

2.6.3 Turning ON/OFF the Power

Turn ON the power of the emulator and user system as simultaneously as possible when the POWER selection jumper the INT POWER side. Turn OFF the power of the emulator and user system as simultaneously as possible.

Do not leave either the emulator or user system powered on, because of leakage current the internal circuits may be damaged. When the POWER selection jumper the EXT POWER side and the on-chip oscillator is operating, it is possible to turn ON/OFF the power of the user system.

When turning ON the power again after shutting OFF the power, wait for about 10 seconds.

IMPORTANT

Note on the Emulator's Pin VCC:

- The emulator's pin VCC is connected to the user system in order to monitor user system voltage.

2.6.4 LED Display When the Emulator Starts Up Normally

Figure 2.4 shows upper panel LED lighting status when the emulator started up properly. Check it when starting up the emulator system.

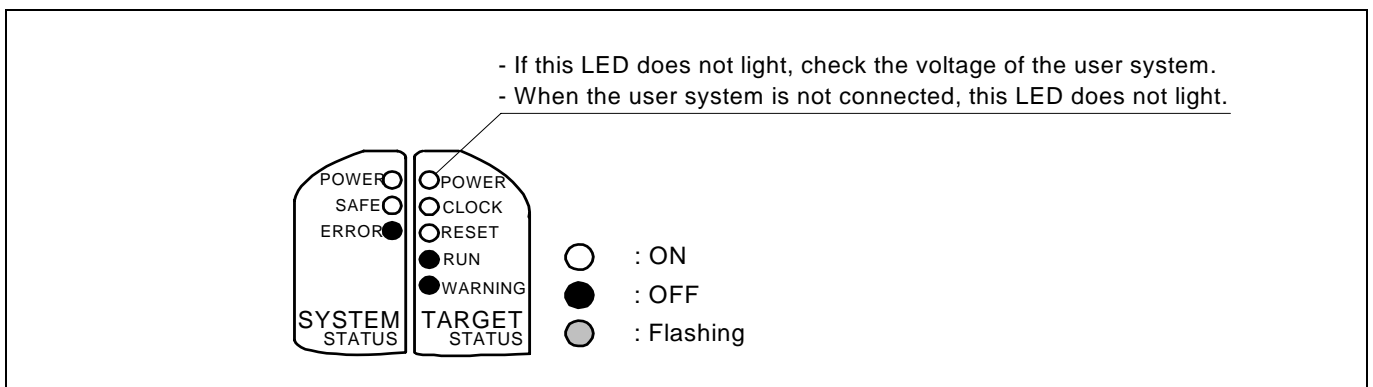

Figure 2.4 LED display when the power turned on PC7501

2.7 Downloading Firmware

2.7.1 When It is Necessary to Download Firmware

Normally, the following are automatically detected when the emulator debugger is started up, and the firmware is downloaded. It is necessary to download the firmware when:

- (1) you use this product for the first time
- (2) the firmware has been upgraded
- (3) the emulator debugger has been upgraded
- (4) you use this product with a PC7501 which was previously used with other emulation probe

If downloading firmware is not completed in the cases below, redownload the firmware.

- When the power is unexpectedly shut down during a download from the emulator debugger
- When a communications interface cable is unexpectedly pulled out

2.7.2 Downloading Firmware in Maintenance Mode

Download the firmware in maintenance mode as explained here following. **The user system must not be connected when downloading the firmware.** Figure 2.5 shows the LED display on the upper panel of the PC7501 when downloading firmware in maintenance mode.

- (1) Set the interface select switch on the rear panel of the PC7501 to the LPT side and connect the LPT parallel interface cable to the PC7501 and the host machine.
- (2) Within 2 seconds of activating power to the emulator, press the RESET switch on the PC7501 front panel to switch to maintenance mode.

Switched to maintenance mode, the SAFE SYSTEM STATUS LED begins to flash.

- (3) Start up the emulator debugger. When the Init dialog box setup is complete, the dialog which urges to download the firmware will appear. Download the firmware following messages. Required time for downloading the firmware is about 60 seconds.

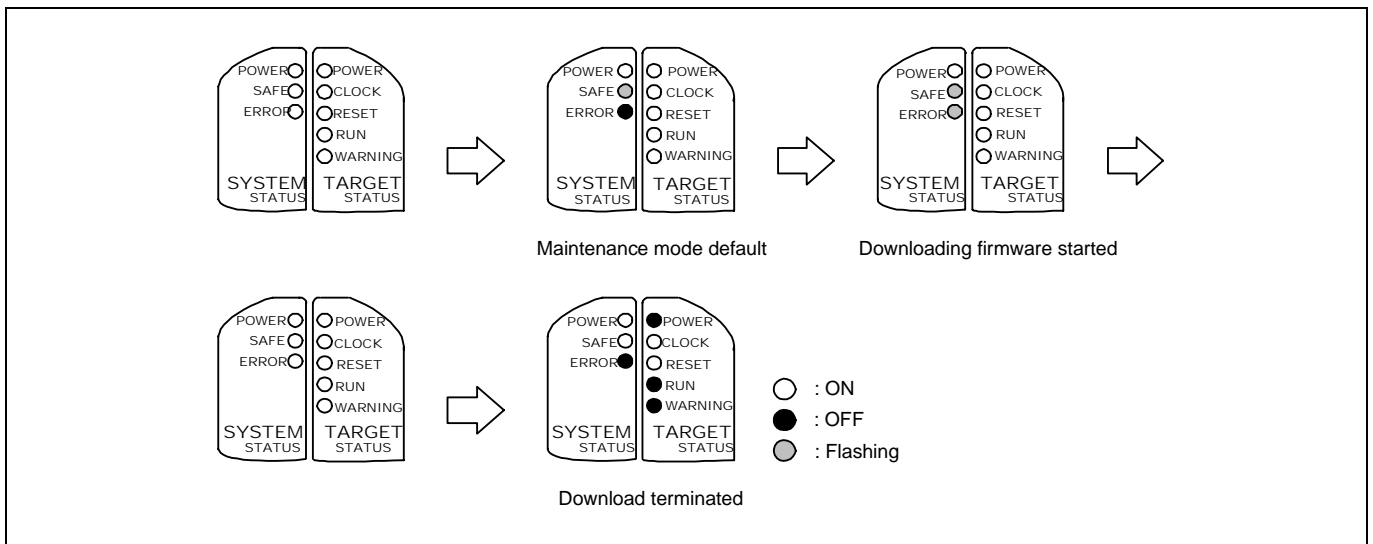

Figure 2.5 Downloading firmware in maintenance mode

IMPORTANT

Note on Downloading Firmware:

- Do not shut OFF power while the firmware is being downloaded. Doing so, the emulator will not start up properly. If power is shut OFF by mistake, redownload the firmware in maintenance mode.

2.8 Self-check

2.8.1 Self-check Procedure

Self-check is used to verify the emulator function works properly. To run the emulator self-check, do so as explained here below. While the self-check is in progress, LEDs will change as shown in Figure 2.6.

- (1) If the user system is connected, disconnect it.
- (2) Set the switches of the emulation probe as the factory-settings to execute the self-check (see Table 2.1).
- (3) Within 2 seconds of activating power to the emulator, press the system reset switch on the PC7501's front panel to switch the emulator to maintenance mode.
- (4) Check the "SAFE" LED starts flashing and then press the system reset switch again.
- (5) The self-check will start. If the normal result is displayed in about 30 seconds, the self-check terminated normally.

Table 2.1 Switch settings at self-check

Switch	Setting
Jumper switch (JP1)	INT side
Jumper switch (JP2)	UP side

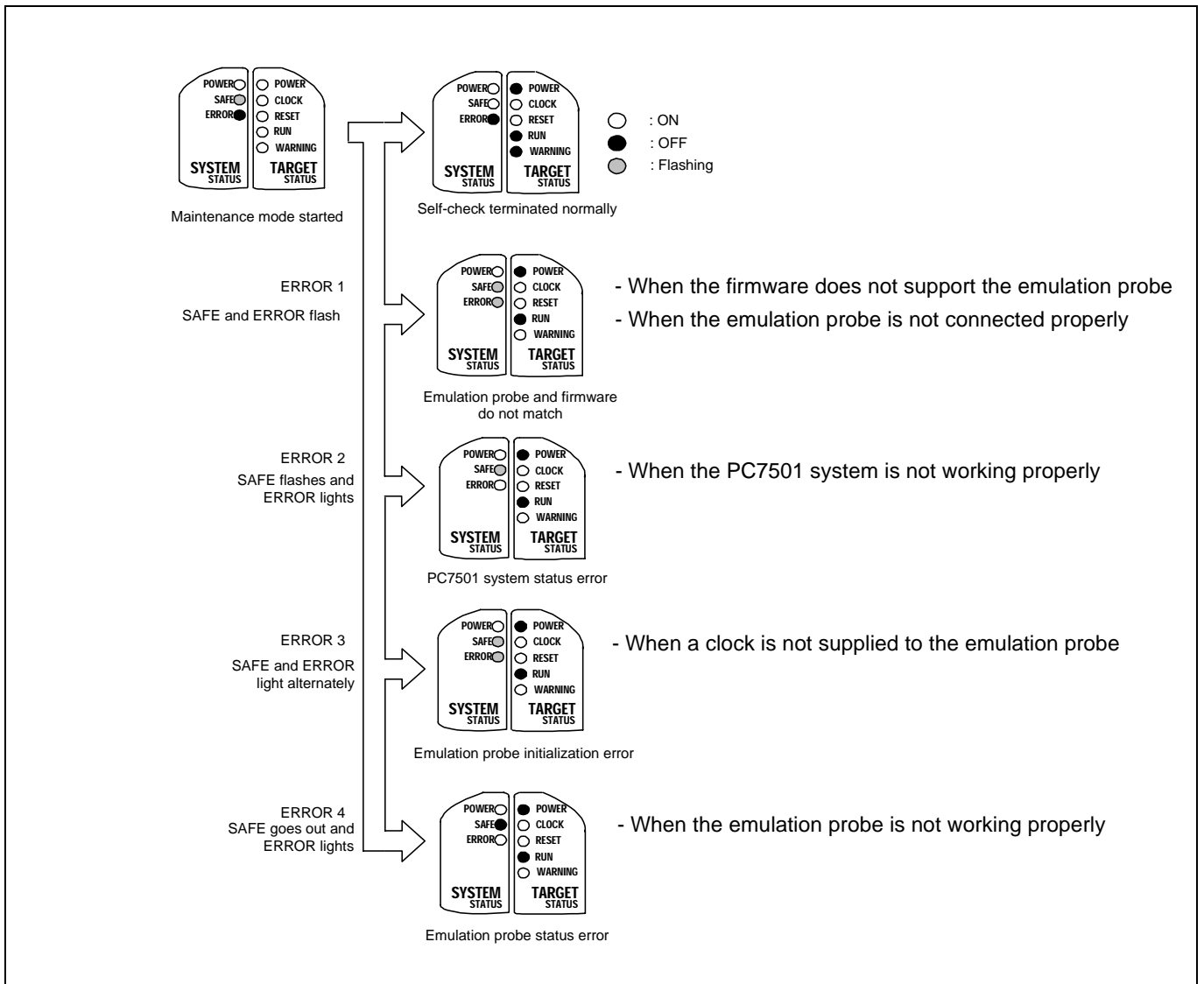

Figure 2.6 Self-check procedure

2.8.2 If an Error is Detected in the Self-check

If the self-check does not result normally (ERROR 1 to ERROR 4 in Figure 2.6), check the following.

- (1) Recheck the connection of the emulation probe and PC7501.
- (2) Redownload the proper firmware.

IMPORTANT

Note on the Self-check:

- If the self-check does not result normally (excluding user system errors), the emulation probe may be damaged. Then contact your local distributor.

2.9 Connecting to the User System

There are four ways available to connect the emulation probe to user systems as shown in Figure 2.7.

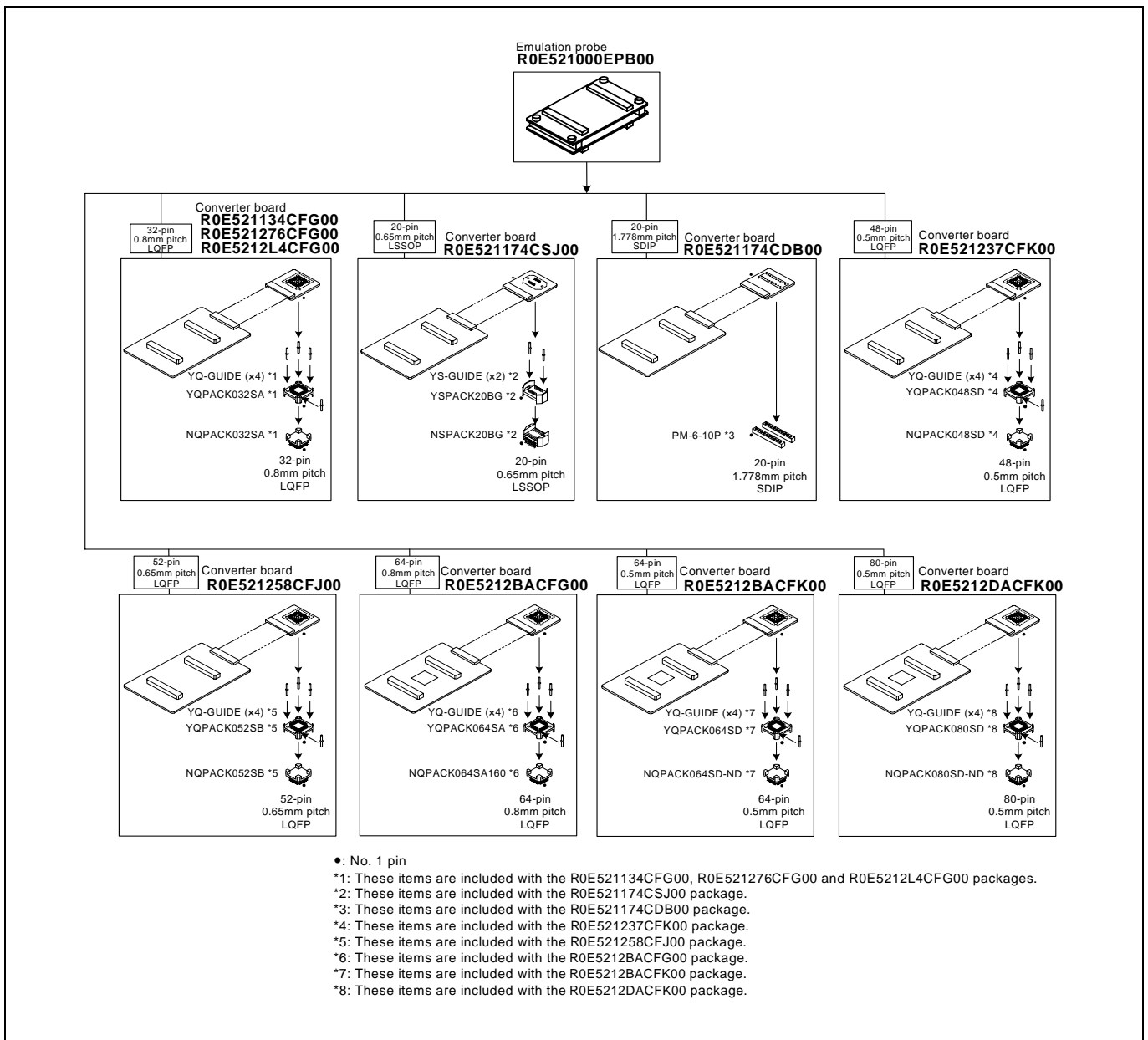

Figure 2.7 Connection of the R0E521000EPB00 and user system

⚠ CAUTION

Note on Connecting to the User System:



- Take care not to attach a converter board in a wrong direction. It may cause a fatal damage to the emulator and user system.

* NQPACK, YQPACK, YQSOCKET, YQ-GUIDE, HQPACK, TQPACK, TQSOCKET, NSPACK, YSPACK, YSSOCKET and YS-GUIDE are trademarks of Tokyo Eletech Corporation.

2.9.1 Connecting to a 32-pin 0.8mm pitch LQFP foot pattern

Figure 2.8 shows how to connect the emulation probe to a 32-pin 0.8mm pitch LQFP foot pattern on the user system with the R0E521134CFG00 (included with the R0E521134EPB00), R0E521276CFG00 (included with the R0E521276EPB00) or R0E5212L4CFG00 (included with the R0E5212L4EPB00) and here following is the procedure.

For details on the R0E521134CFG00, R0E521276CFG00 and R0E5212L4CFG00, refer to each user's manual.

- (1) Mount the NQPACK032SA included with the R0E521134CFG00, R0E521276CFG00 or R0E5212L4CFG00 to the user system.
- (2) Attach the YQPACK032SA included with the R0E521134CFG00, R0E521276CFG00 or R0E5212L4CFG00 to the NQPACK032SA, and fix them with the YQ-GUIDE's.
- (3) Attach the J3 and J4 of the R0E521000EPB00 to the R0E521134CFG00, R0E521276CFG00 or R0E5212L4CFG00.
- (4) Attach the R0E521134CFG00, R0E521276CFG00 or R0E5212L4CFG00 to the YQPACK032SA

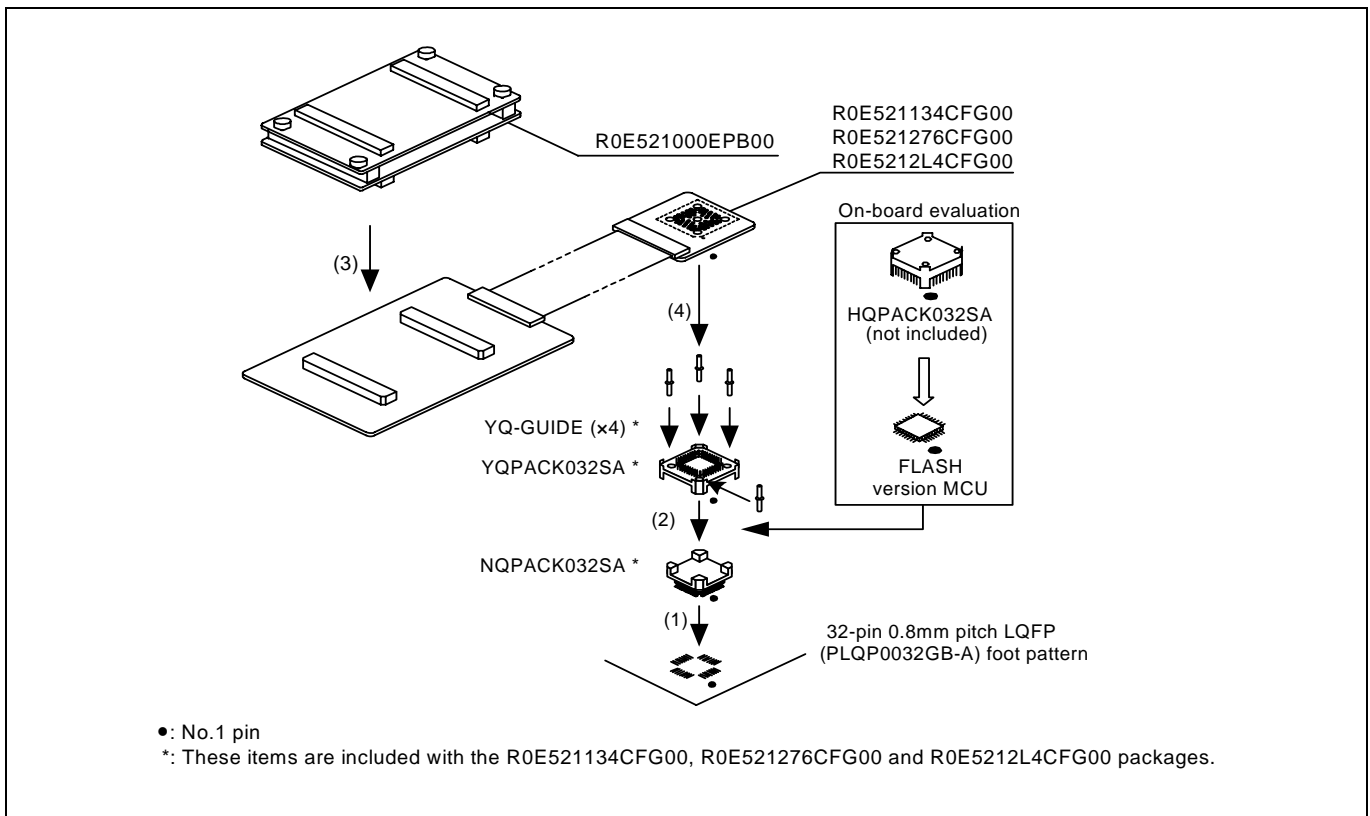

Figure 2.8 Connecting to a 32-pin 0.8mm pitch foot pattern

CAUTION

Note on Connecting to the User System:

- Take care not to attach a converter board in a wrong direction. It may cause a fatal damage to the emulator and user system.

IMPORTANT

Notes on Connectors of the Converter board:

- The connectors of the R0E521000EPB00 and the R0E521134CFG00, R0E521276CFG00 or R0E5212L4CFG00 are guaranteed for only 50 insertion/removal iterations.
- Between the R0E521134CFG00, R0E521276CFG00 or R0E5212L4CFG00 and the YQPACK032SA are guaranteed for only 100 insertion/removal iterations

2.9.2 Connecting to a 20-pin 0.65mm pitch LSSOP Foot Pattern

Figure 2.9 shows how to connect the emulation probe to a 20-pin 0.65mm pitch LSSOP foot pattern on the user system with the R0E521174CSJ00 (included with the R0E521174EPB00) and here following is its procedure.

For details on the R0E521174CSJ00, refer to the user's manual.

- (1) Mount the NSPACK20BG included with the R0E521174CSJ00 to the user system.
- (2) Attach the YSPACK20BG included with the R0E521174CSJ00 to the NSPACK20BG, and fix them with the YS-GUIDE's.
- (3) Attach the J3 and J4 of the R0E521000EPB00 to the R0E521174CSJ00.
- (4) Attach the R0E521174CSJ00 to the YSPACK20BG.

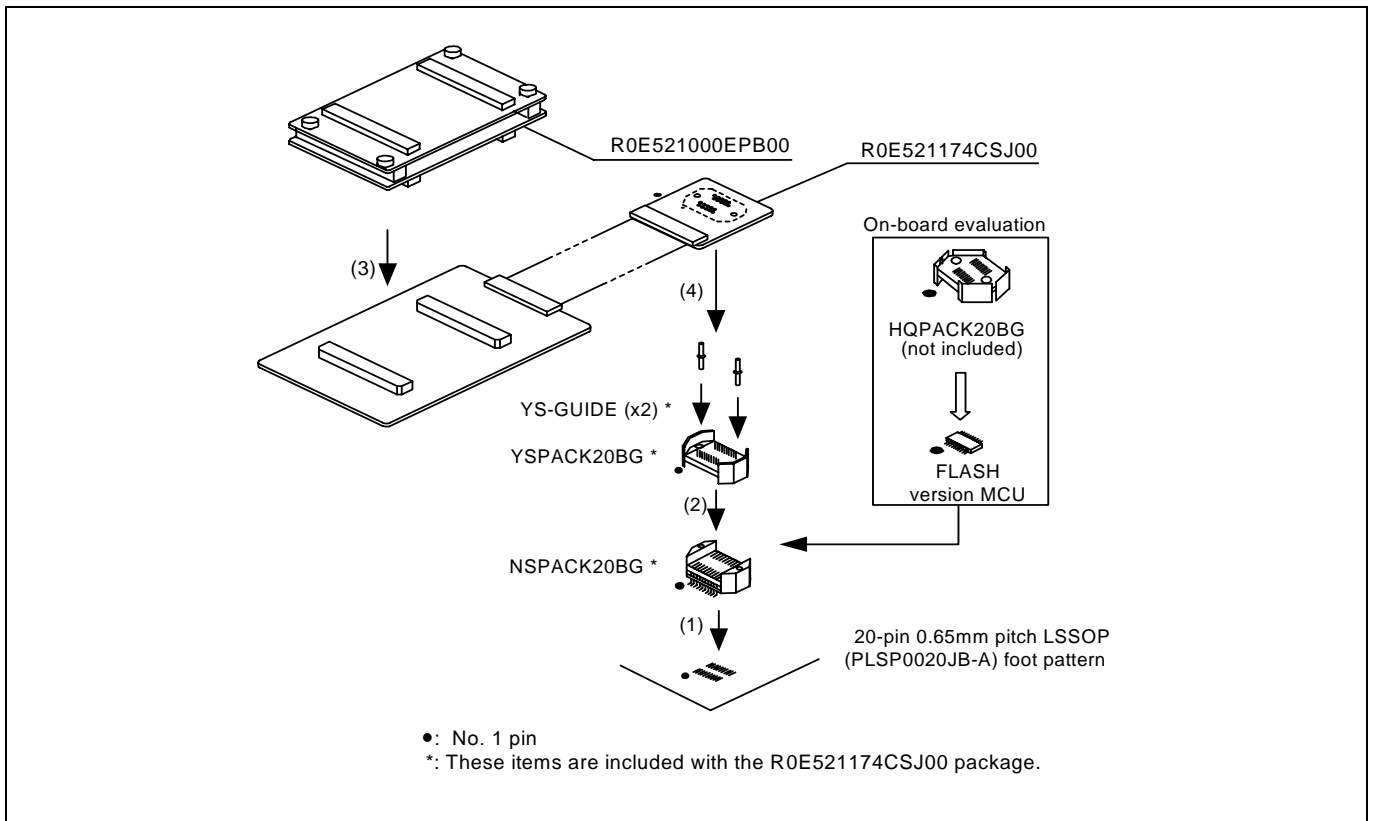

Figure 2.9 Connecting to a 20-pin 0.65mm pitch LSSOP foot pattern

CAUTION

Note on Connecting to the User System:



- Take care not to attach a converter board in a wrong direction. It may cause a fatal damage to the emulator and user system.

IMPORTANT

Notes on Connectors of the Converter Board:

- The small connectors of the R0E521000EPB00 and R0E521174CSJ00 are guaranteed for only 50 insertion/removal iterations.
- Between the R0E521174CSJ00 and the YSPACK20BG are guaranteed for only 100 insertion/removal iterations

2.9.3 Connecting to a 20-pin 1.778mm pitch SDIP Foot Pattern

Figure 2.10 shows how to connect the emulation probe to a 20-pin 1.778mm pitch SDIP foot pattern on the user system with the R0E521174CDB00 (included with the R0E521174EPB10) and here following is its procedure.

For details on the R0E521174CDB00, refer to the user's manual.

- (1) Mount the two pieces of PM-6-10P (10-conductor) included with the R0E521174CDB00 to the user system.
- (2) Attach the J3 and J4 of the R0E521000EPB00 to the R0E521174CDB00.
- (3) Attach the R0E521174CDB00 to the PM-6-10P.

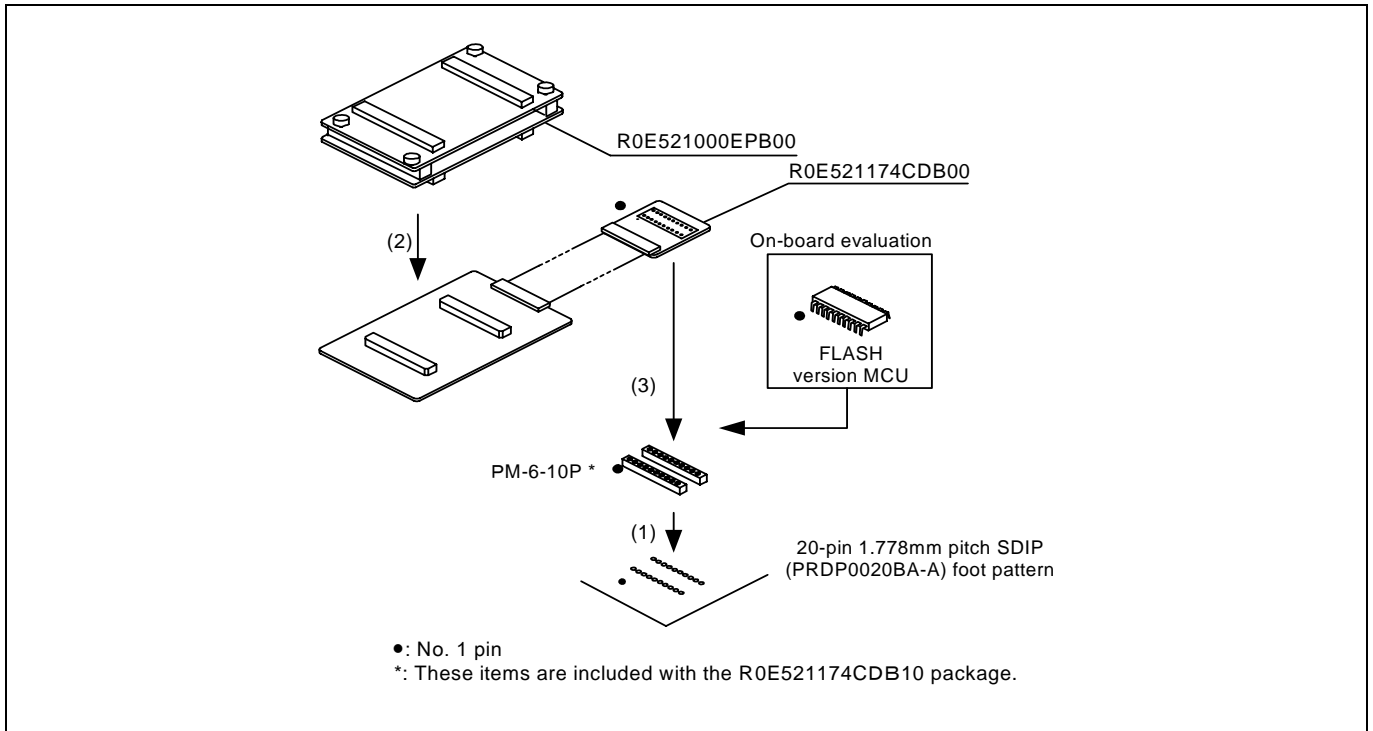

Figure 2.10 Connecting to a 20-pin 1.778mm pitch SDIP foot pattern

⚠ CAUTION

Note on Connecting to the User System:



- Take care not to attach a converter board in a wrong direction. It may cause a fatal damage to the emulator and user system.

IMPORTANT

Notes on Connectors of the Converter Board:

- The small connectors of the R0E521000EPB00 and R0E521174CDB00 are guaranteed for only 50 insertion/removal iterations.
- Between the R0E521174CDB00 and the PM-6-10P are guaranteed for only 100 insertion/removal iterations

2.9.4 Connecting to a 48-pin 0.5mm pitch LQFP Foot Pattern

Figure 2.11 shows how to connect the emulation probe to a 48-pin 0.5mm pitch LQFP foot pattern on the user system with the R0E521237CFK00 (included with the R0E521237EPB00) and here following is its procedure.

For details on the R0E521237CFK00, refer to the user's manual.

- (1) Mount the NQPACK048SD included with the R0E521237CFK00 to the user system.
- (2) Attach the YQPACK048SD included with the R0E521237CFK00 to the NQPACK048SD, and fix them with the YQ-GUIDE's.
- (3) Attach the J3 and J4 of the R0E521000EPB00 to the R0E521237CFK00.
- (4) Attach the R0E521237CFK00 to the YQPACK048SD

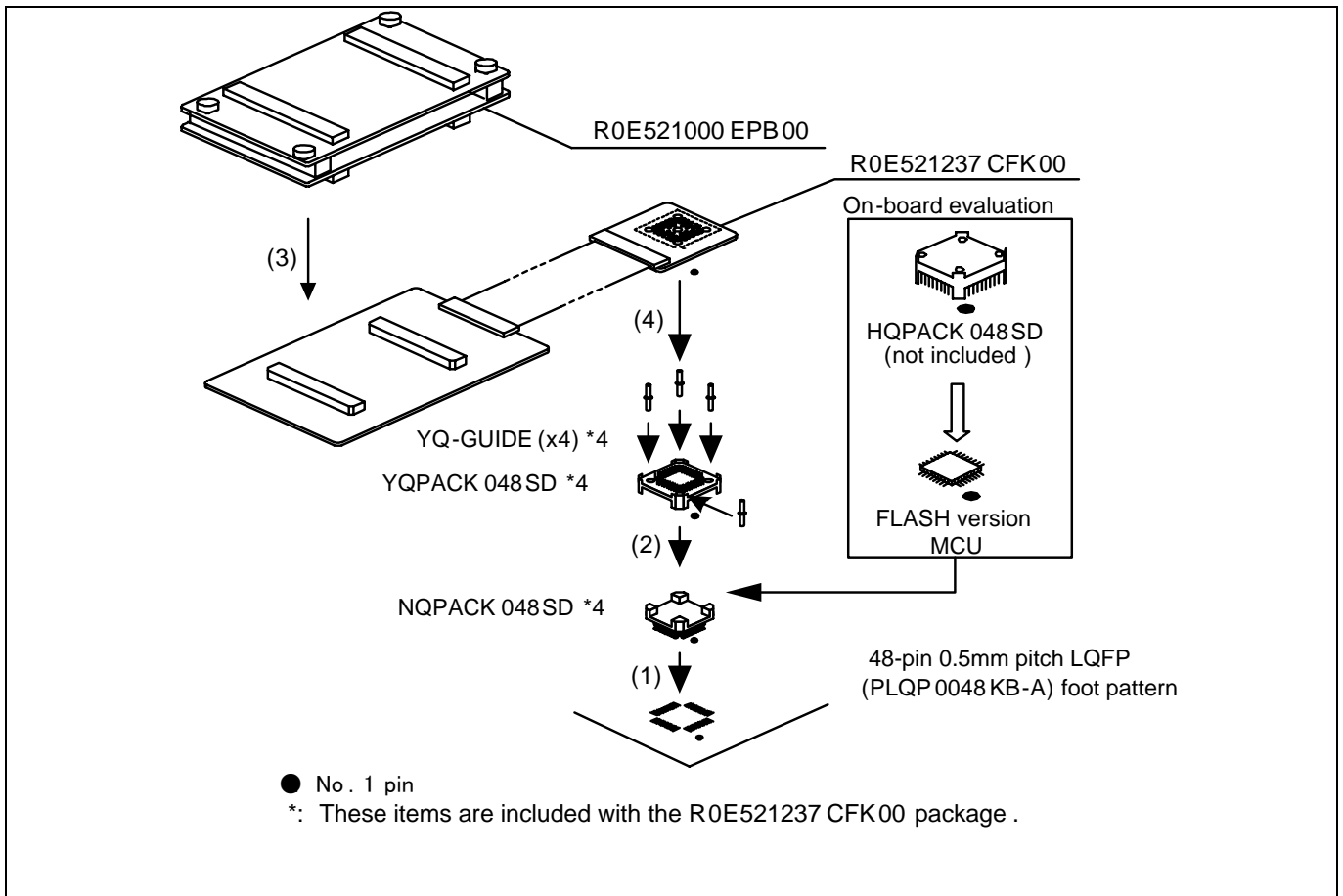

Figure 2.11 Connecting to a 48-pin 0.5mm pitch LQFP foot pattern

CAUTION

Note on Connecting to the User System:



- Take care not to attach a converter board in a wrong direction. It may cause a fatal damage to the emulator and user system.

IMPORTANT

Notes on Connectors of the Converter Board:

- The small connectors of the R0E521000EPB00 and R0E521237CFK00 are guaranteed for only 50 insertion/removal iterations.
- Between R0E521237CFK00 and the YQPACK048SD are guaranteed for only 100 insertion/removal iterations

2.9.5 Connecting to a 52-pin 0.65mm pitch LQFP Foot Pattern

Figure 2.12 shows how to connect the emulation probe to a 52-pin 0.65mm pitch LQFP foot pattern on the user system with the R0E521258CFJ00 (included with the R0E521258EPB00) and here following is its procedure.

For details on the R0E521258CFJ00, refer to the user's manual.

- (1) Mount the NQPACK052SB included with the R0E521258CFJ00 to the user system.
- (2) Attach the YQPACK052SB included with the R0E521258CFJ00 to the NQPACK052SB, and fix them with the YQ-GUIDE's.
- (3) Attach the J3 and J4 of the R0E521000EPB00 to the R0E521258CFJ00.
- (4) Attach the R0E521258CFJ00 to the YQPACK052SB.

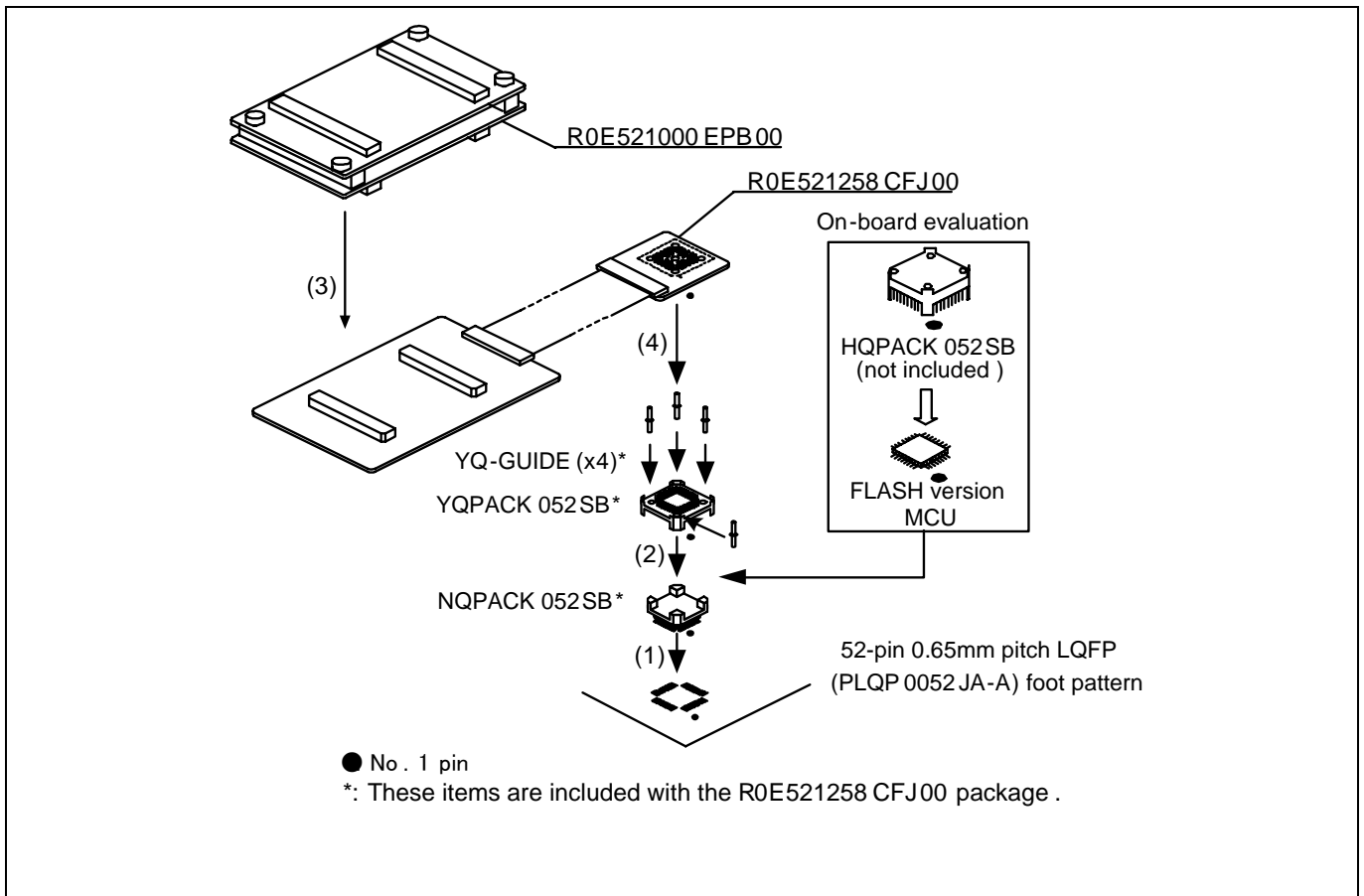

Figure 2.12 Connecting to a 52-pin 0.65mm pitch LQFP foot pattern

CAUTION

Note on Connecting to the User System:



- Take care not to attach a converter board in a wrong direction. It may cause a fatal damage to the emulator and user system.

IMPORTANT

Notes on Connectors of the Converter Board:

- The small connectors of the R0E521000EPB00 and R0E521258CFJ00 are guaranteed for only 50 insertion/removal iterations.
- Between R0E521258CFJ00 and the YQPACK052SB are guaranteed for only 100 insertion/removal iterations

2.9.6 Connecting to a 64-pin 0.8mm pitch LQFP Foot Pattern

Figure 2.13 shows a procedure of connecting to a 64-pin 0.8mm pitch LQFP foot pattern on the user system using the R0E5212BACFG00 (included with the R0E5212BAEPB00). For details on the R0E5212BACFG00, refer to its user's manual.

- (1) Mount the NQPACK064SA160 included with the R0E5212BACFG00 to the user system.
- (2) Attach the YQPACK064SA included with the R0E5212BACFG00 to the NQPACK064SA160 and secure it with the YQ-GUIDE's.
- (3) Attach the R0E5212BACFG00 to the J3 and J4 of the R0E521000EPB00.
- (4) Attach the R0E5212BACFG00 to the YQPACK064SA.

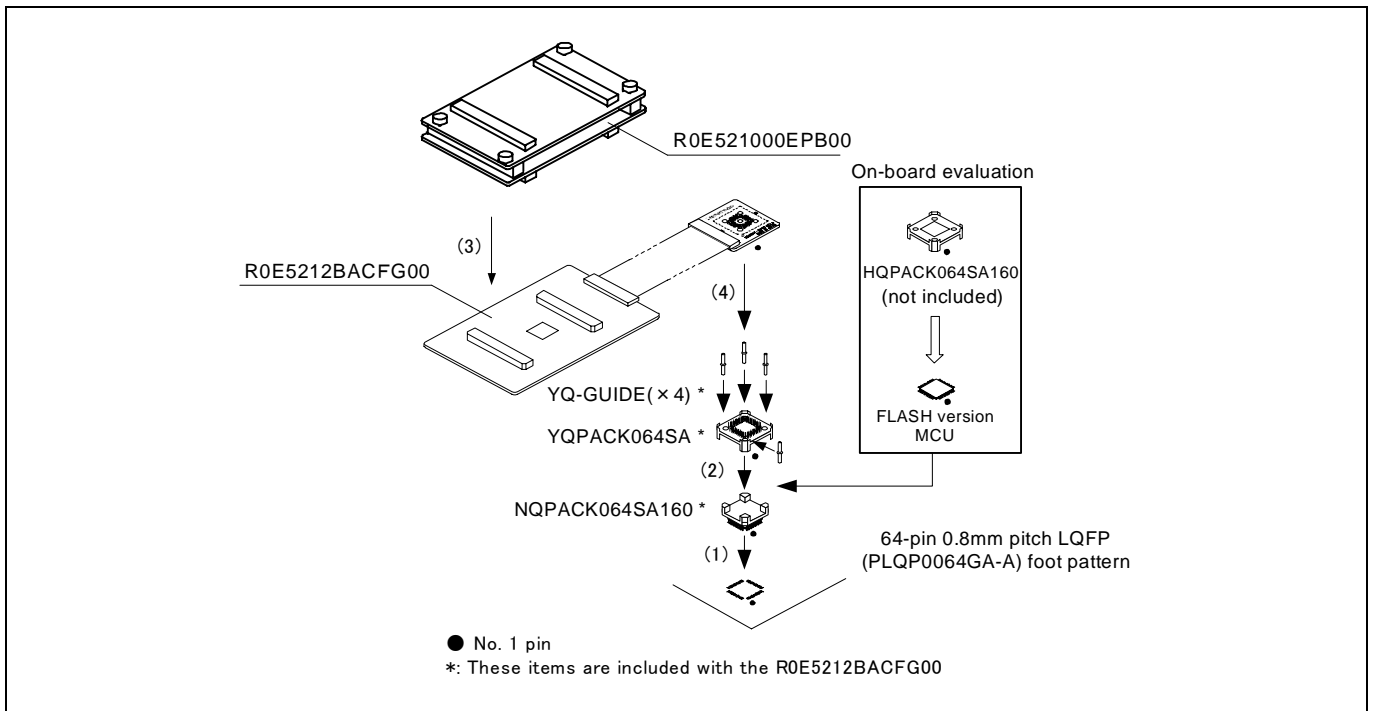

Figure 2.13 Connecting to a 64-pin 0.8mm pitch LQFP foot pattern

CAUTION

Note on Connecting to the User System:



- Take care not to attach a converter board in a wrong direction. It may cause a fatal damage to the emulator and user system.

IMPORTANT

Notes on Connectors of the Converter Board:

- The connectors of the R0E521000EPB00 and R0E5212BACFG00 are guaranteed for only 50 insertion/removal iterations.
- The connectors of the R0E5212BACFG00 and YQPACK064SA are guaranteed for only 100 insertion/removal iterations.

2.9.7 Connecting to a 64-pin 0.5mm pitch LQFP Foot Pattern

Figure 2.14 shows a procedure of connecting to a 64-pin 0.5mm pitch LQFP foot pattern on the user system using the R0E5212BACFK00 (included with the R0E5212BAEPB10). For details on the R0E5212BACFK00, refer to its user's manual.

- (1) Mount the NQPACK064SD-ND included with the R0E5212BACFK00 to the user system.
- (2) Attach the YQPACK064SD included with the R0E5212BACFK00 to the NQPACK064SD-ND and secure it with the YQ-GUIDE's.
- (3) Attach the R0E5212BACFK00 to the J3 and J4 of the R0E521000EPB00.
- (4) Attach the R0E5212BACFK00 to the YQPACK064SD.

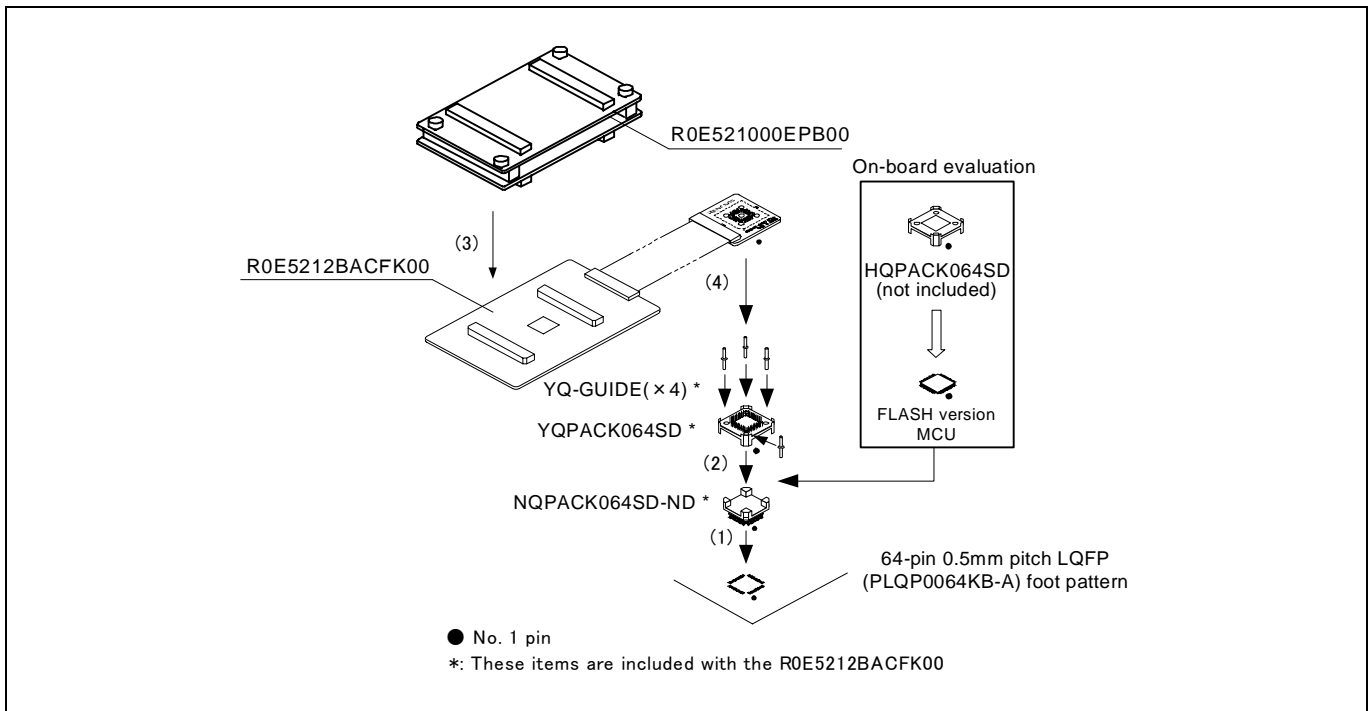

Figure 2.14 Connecting to a 64-pin 0.5mm pitch LQFP foot pattern

CAUTION

Note on Connecting to the User System:



- Take care not to attach a converter board in a wrong direction. It may cause a fatal damage to the emulator and user system.

IMPORTANT

Notes on Connectors of the Converter Board:

- The connectors of the R0E521000EPB00 and R0E5212BACFK00 are guaranteed for only 50 insertion/removal iterations.
- The connectors of the R0E5212BACFK00 and YQPACK064SD are guaranteed for only 100 insertion/removal iterations.

2.9.8 Connecting to an 80-pin 0.5mm pitch LQFP Foot Pattern

Figure 2.15 shows a procedure of connecting to an 80-pin 0.5mm pitch LQFP foot pattern on the user system using the R0E5212DACFK00 (included with the R0E5212DAEPB00). For details on the R0E5212DACFK00, refer to its user's manual.

- (1) Mount the NQPACK080SD-ND included with the R0E5212DACFK00 to the user system.
- (2) Attach the YQPACK080SD included with the R0E5212BACFK00 to the NQPACK080SD-ND and secure it with the YQ-GUIDE's.
- (3) Attach the R0E5212DACFK00 to the J3 and J4 of the R0E521000EPB00.
- (4) Attach the R0E5212DACFK00 to the YQPACK080SD.

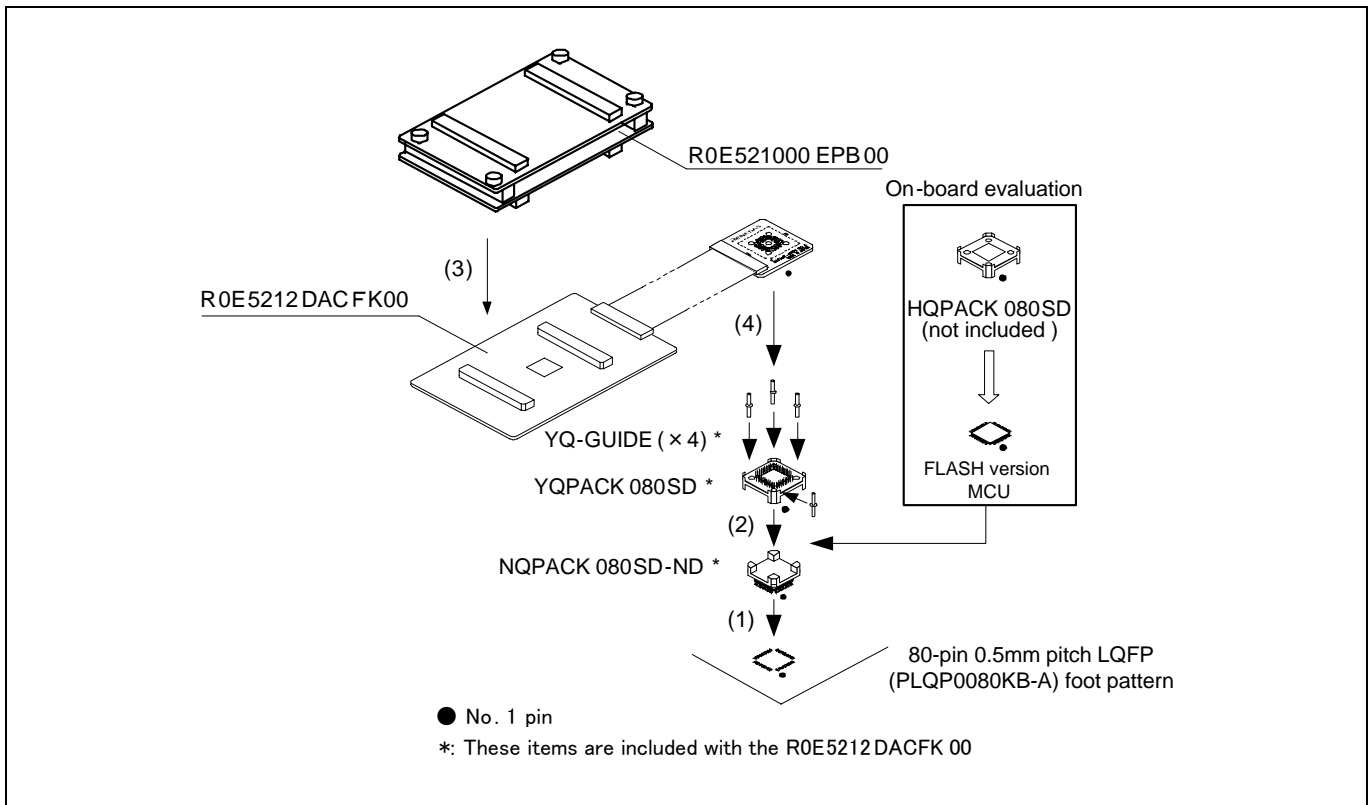

Figure 2.15 Connecting to an 80-pin 0.5mm pitch LQFP foot pattern

CAUTION

Note on Connecting to the User System:



- Take care not to attach a converter board in a wrong direction. It may cause a fatal damage to the emulator and user system.

IMPORTANT

Notes on Connectors of the Converter Board:

- The connectors of the R0E521000EPB00 and R0E5212DACFK00 are guaranteed for only 50 insertion/removal iterations.
- The connectors of the R0E5212DACFK00 and YQPACK080SD are guaranteed for only 100 insertion/removal iterations.

2.10 Setting Switches

2.10.1 Setting the Jumper on the Emulation Probe

Figure 2.16 shows the location of jumper switches on the R0E521000EPBM0 board and their factory-settings.

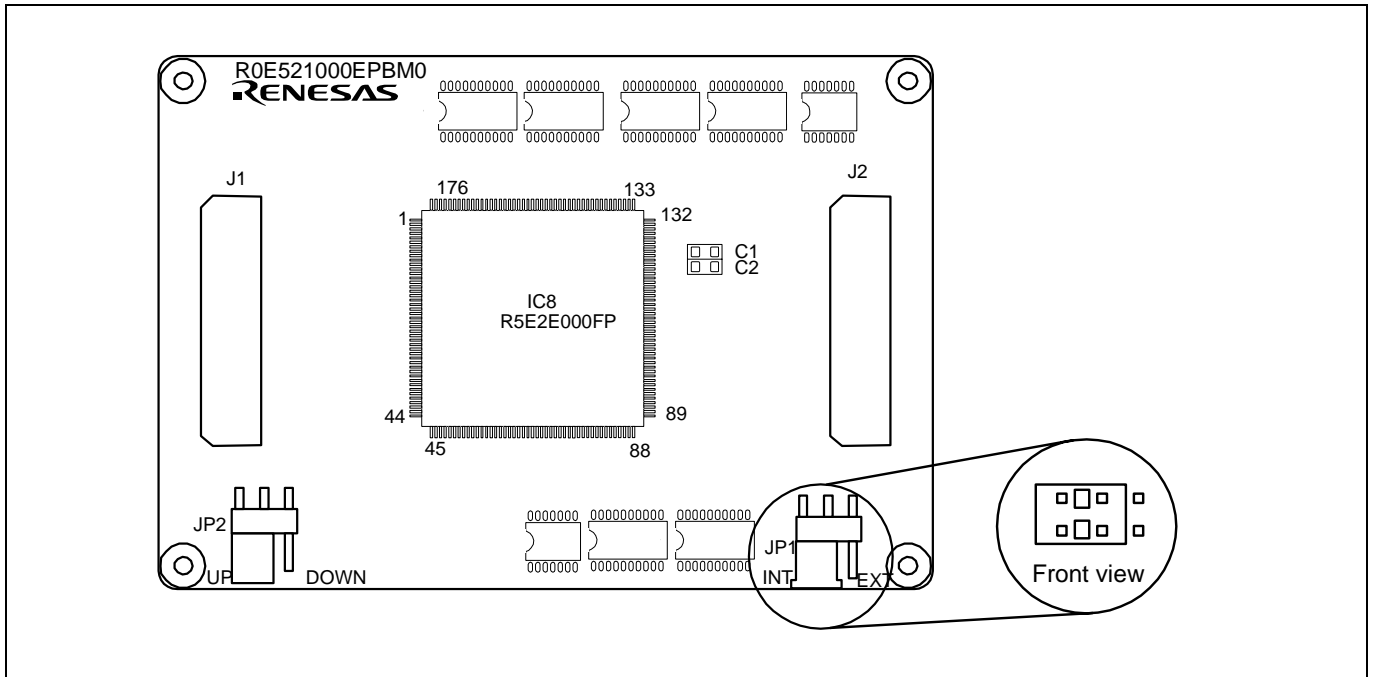

Figure 2.16 Jumper switches on the R0E521000EPBM0

Table 2.2 Setting jumper switches on the R0E521000EPBM0

Switch No.	Switch name	How to set	Description
JP1	POWER selection jumper		Settings of this jumper need to be changed according to the power supply voltage and power supply condition of the user system. The internal power supply is supplied to the evaluation MCU in factory setting. For details, refer to “2.10.2 “Setting the POWER Selection Jumper” (page 39).
JP2	RESET pin pullup jumper		This jumper pulls the user system’s RESET pin high with 510 kΩ. Although settings of this jumper do not normally need to be changed, if the 510 kΩ pullup presents a problem when the user system is connected, the board may be used without this resistor pullup.

⚠ CAUTION

Note on Changing Jumper Settings:



- Always shut OFF the emulator before changing the setting of the jumper switches, and connecting the cable. Otherwise the internal circuit may cause a break.

2.10.2 Setting the POWER Selection Jumper

The POWER select jumper needs to be set depending on the user system's power supply voltage and power supply condition. If the system is used with power supply voltages in the range 2.7 to 5.5 [V], leave the POWER select jumper as set to the INT side, which is the default setting. If the system is used with power supply voltages less than 2.7 [V], change the POWER select jumper's setting to the EXT side. When the POWER selection jumper is set to the EXT POWER side, this product consumes max. 500 mA of electrical current from the user system. Table 2.3 shows the POWER selection jumper switch settings.

Table 2.3 Setting jumper switches on the R0E521000EPBM0

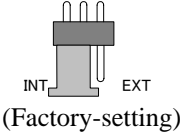
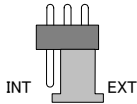
Switch No.	Switch name	How to set	Description
JP1	POWER selection jumper		When using this system with power supply voltages in the range 2.7 to 5.5 V.
			Set the jumper to this position when the user system's power supply voltage is less than 2.7 [V] and the user system's power supply is to be turned on/off.

When the POWER selection jumper is changed to the EXT side, following operations can be performed from the debugger while the user system's power supply is turned off:

- (1) Starting up the debugger while the user system's power supply is turned off, as well as downloading a program and referencing or altering memory contents
- (2) Starting program execution (by causing the program to run from an idle state, with the MCU in a reset state) while the user system's power supply is turned off, and then executing the program from a reset vector read phase when the user system is powered up.

Furthermore, if the CPU clock is supplied by an on-chip oscillator, the following user system power on/off operations can also be performed:

- (3) Turning the user system's power supply off during program execution and stopping the user program (by causing the program to stop from the RUN state) while the power supply is turned off (the MCU in a reset state)
- (4) Turning the user system's power supply on or off while the user program is running or idle

Note, however, that since the reset pin is controlled from the emulator side, the high-going transitions of the VCC and RESET pins for user system power-on occur with different timing, the power-on reset function of the MCU cannot be debugged.

⚠ CAUTION

Notes on Setting the POWER Selection Jumper:



- The user system's power supply can be turned on/off only when the POWER selection jumper is set to the EXT side. If an attempt is made to turn the user system's power supply on or off while the jumper is set to the INT side, the internal circuit of the emulator or the user system may break down. Therefore, such an operation is strictly prohibited.
- When the POWER selection jumper is switched to the EXT side, the upper limit of the external trigger input level (VI) is 3.6 [V]. If the power voltage exceeding this limit, the internal circuit may be damaged.

IMPORTANT

Notes on the EXT Setting of the POWER Selection Jumper:

- With this product, the MCU's power-on reset function for user system power-on cannot be emulated.
- The user system's power supply can be turned on/off only when the system is operating with an on-chip oscillator, and cannot be turned on or off when operating with XIN or XCIN.

2.10.3 Selecting Clock Supply

You can choose a clock supplied to the evaluation MCU by the Emulator tab in the Init dialog box of the emulator debugger. Table 2.4 shows the clocks and their initial settings.

Table 2.4 Clock supply to the MCU and default settings

Clock	Display of emulator debugger	Description	Default setting
Main (XIN-XOUT)	Internal	Internal oscillator circuit (OSC-3 or OSC-2)	Yes
	External	Oscillator of user system	-
	Generated	Internal generator circuit (1.0 to 20.0 MHz)	-
Sub (XCIN-XCOU)	Internal	Internal oscillator circuit (32.768 kHz)	-
	External	Oscillator of user system	Yes

IMPORTANT

Note on Changing the Clock Supply:

- The clock supply can be set by the Init dialog box when starting up the emulator debugger or inputting CLK command on the script window.

(1) Using an Internal Oscillator Circuit Board

1) Kinds of Oscillator Circuit Boards

The PC7501 comes with an oscillator circuit board OSC-3 (30 MHz). And an oscillator circuit board OSC-3 (20 MHz) and an oscillator circuit board OSC-2 (bare board) are included with this product. If you use the internal oscillator circuit board OSC-3 (20 MHz) or OSC-2 as a main clock, choose "Internal" in the emulator debugger after replacing oscillator circuit boards in the PC7501 to change a clock supplied to an MCU.

2) Replacing an Oscillator Circuit Board

Remove the four screws of both sides of the PC7501 and lift off the upper cover (see Figure 2.17).

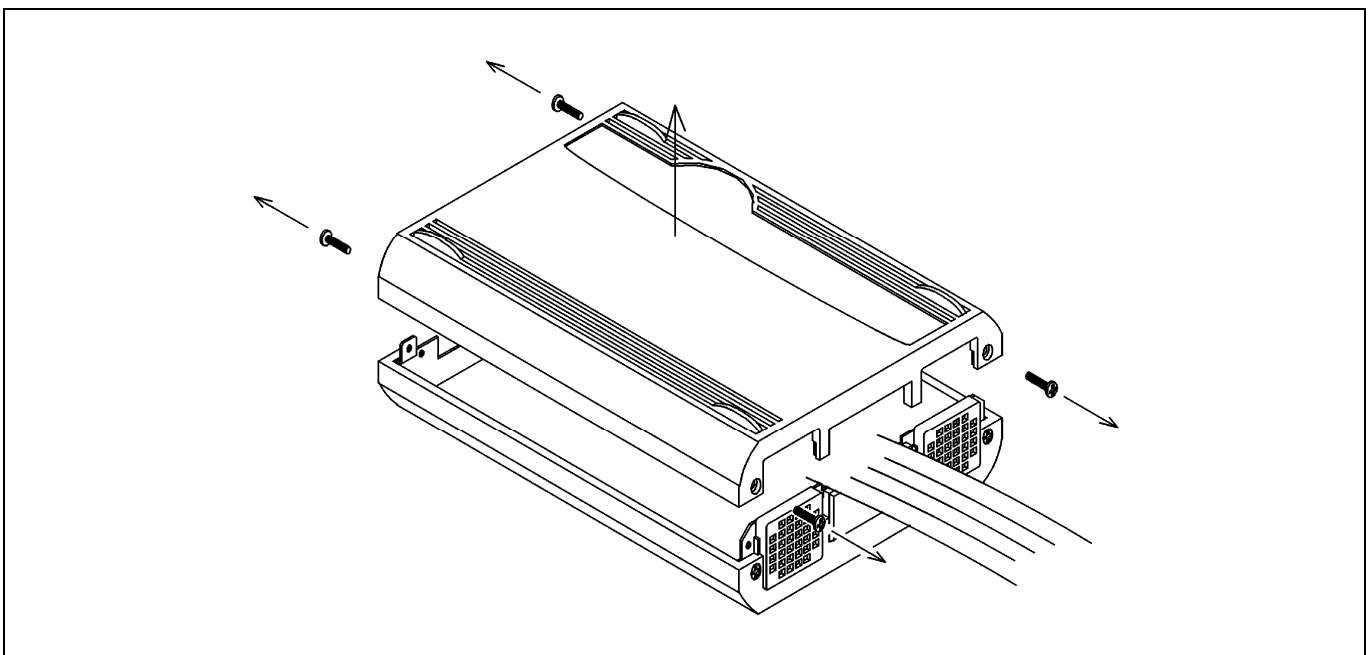

Figure 2.17 Removing the upper cover

Unscrew the screw of the oscillator circuit board of the PC7501 and replace it (see Figure 2.18).

 <p>Oscillator circuit board</p>	<p>The oscillator circuit board of the PC7501 is in the lower right corner of the board.</p>
	<p>Unscrew the screw securing the oscillator circuit board.</p>
	<p>Lift off the oscillator circuit board.</p>
	<p>Attach replacing oscillator circuit board to the connector.</p>
	<p>Secure the new oscillator circuit board with the screw.</p>

Figure 2.18 Replacing oscillator circuit boards

Reinstall the upper cover once removed and secure the four screws of the PC7501.

⚠ CAUTION

When Removing the Upper Cover:

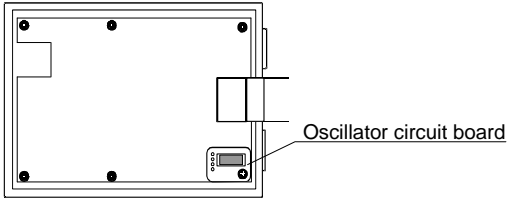
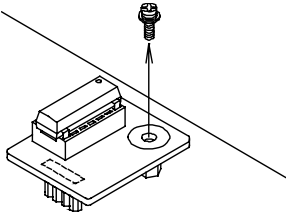
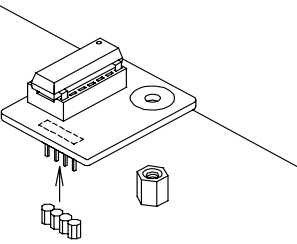
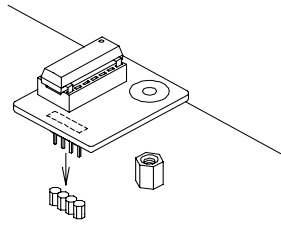
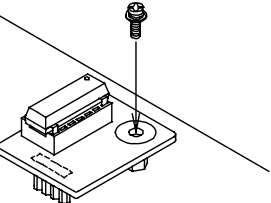

- Always shut OFF power when removing the upper cover or changing the oscillator circuit board. Otherwise the internal circuit may be damaged.

3) Using the Oscillator Circuit Bare Board

To use this product at a frequency you like, build a desired oscillator circuit on the included OSC-2 oscillator circuit bare board. Figure 2.19 shows an external view of the OSC-2 oscillator circuit bare board and the connector pin locations. Figure 2.20 shows the circuitry of the oscillator circuit bare board OSC-2. Use the circuit constants recommended by the oscillator manufacturer.

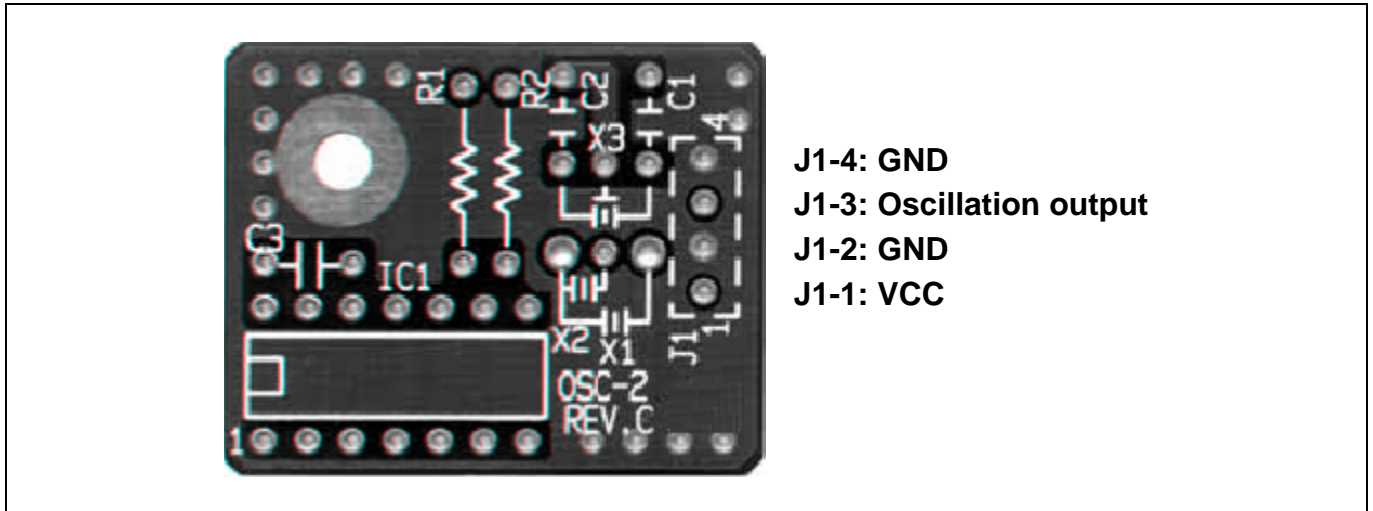

Figure 2.19 External view of the oscillator board OSC-2 (bare board) and connector pin assignments

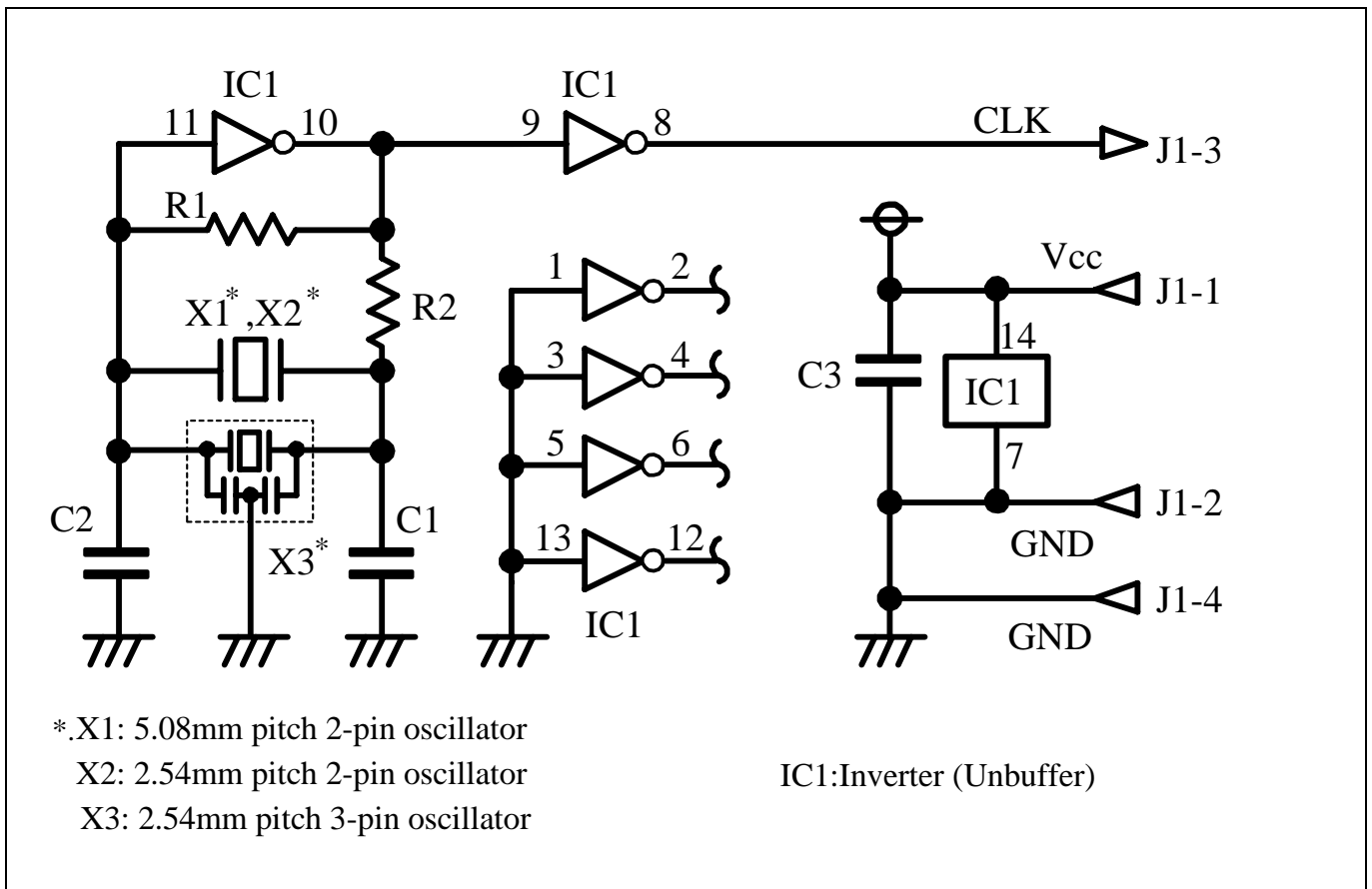

Figure 2.20 Circuit of the oscillator board OSC-2 (bare board)

(2) Using the Oscillator Circuit on the User System

To operate this product with an oscillator circuit of the user system, input the oscillator output at 50% duty (within the operating range of the evaluation MCU) into pin X_{IN} as shown in Figure 2.21. Pin X_{OUT} should be open. Choose "External" in the emulator debugger to use this clock.

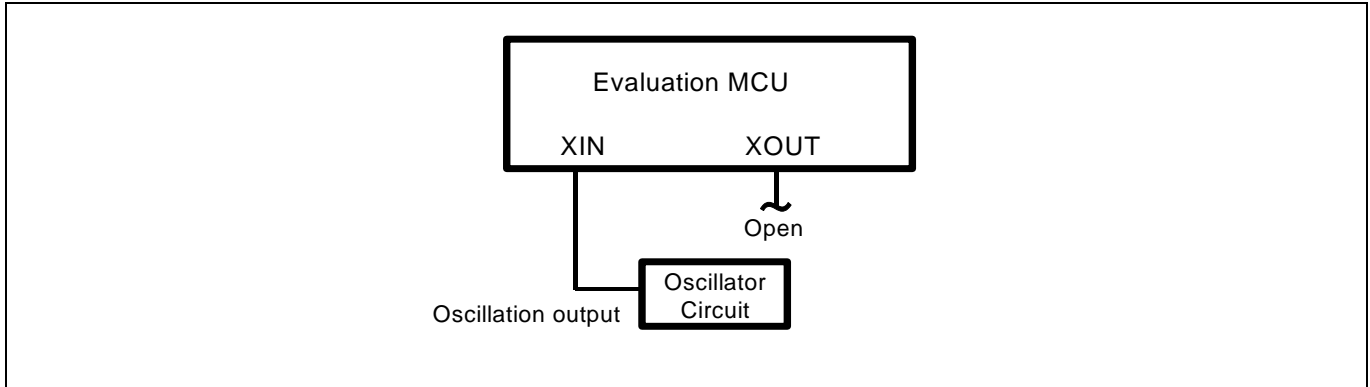

Figure 2.21 External oscillator circuit

In the oscillator circuit shown in Figure 2.22 where a resonator is connected between pins X_{CIN} and X_{COUT} , oscillation does not occur because a package converter board is used between the evaluation MCU and the user system. It is same for X_{CIN} and X_{COUT} .

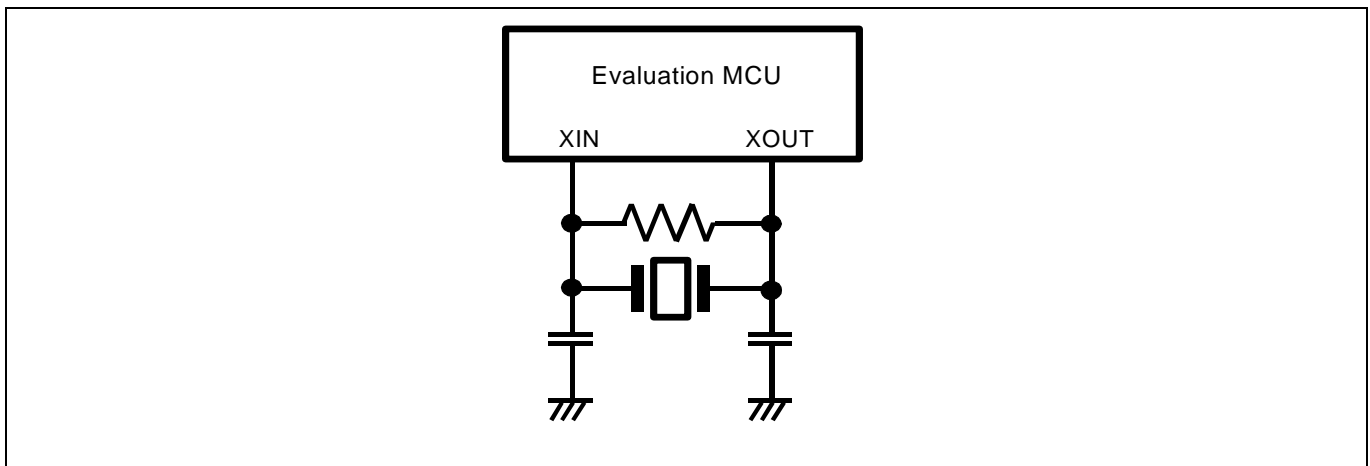

Figure 2.22 Circuit which is not be usable with the emulator

(3) Using the Internal Oscillator Circuit

The dedicated circuit in the PC7501 can generate any arbitrary frequency specified by the emulator debugger, and it is supplied as a main clock. It does not depend on either the oscillator circuit board in the PC7501 or the oscillator circuit on the user system. If you want to debug programs without the user system or change a frequency temporarily, you can check its operation before preparing an oscillator. If you want to use the internal oscillator circuit of the PC7501 as a main clock, choose "Generated" in the emulator debugger and specify a frequency you like to use for this clock supplied to an MCU.

Although you can change a frequency between 1.0 and 99.9 MHz by 0.1 MHz for the PC7501, do not specify a value exceeding the maximum input frequency of the X_{IN} of the MCU.

IMPORTANT

Notes on Internal Oscillator Circuit:

- The internal generator circuit is equipped for temporary debugging purposes. Temperature characteristics of frequencies are not guaranteed.
- Be sure to evaluate your system with an oscillator or oscillator module whose frequency is same as that of the internal oscillator circuit (internal clock) for final evaluation purposes.

2.10.4 A/D Conversion Bypass Capacitors

There is a foot pattern on the R0E521000EPBM0 board for mounting bypass capacitors for the A/D conversion circuit. Mount applicable bypass capacitors as occasion demands. Figure 2.23 shows where they are installed.

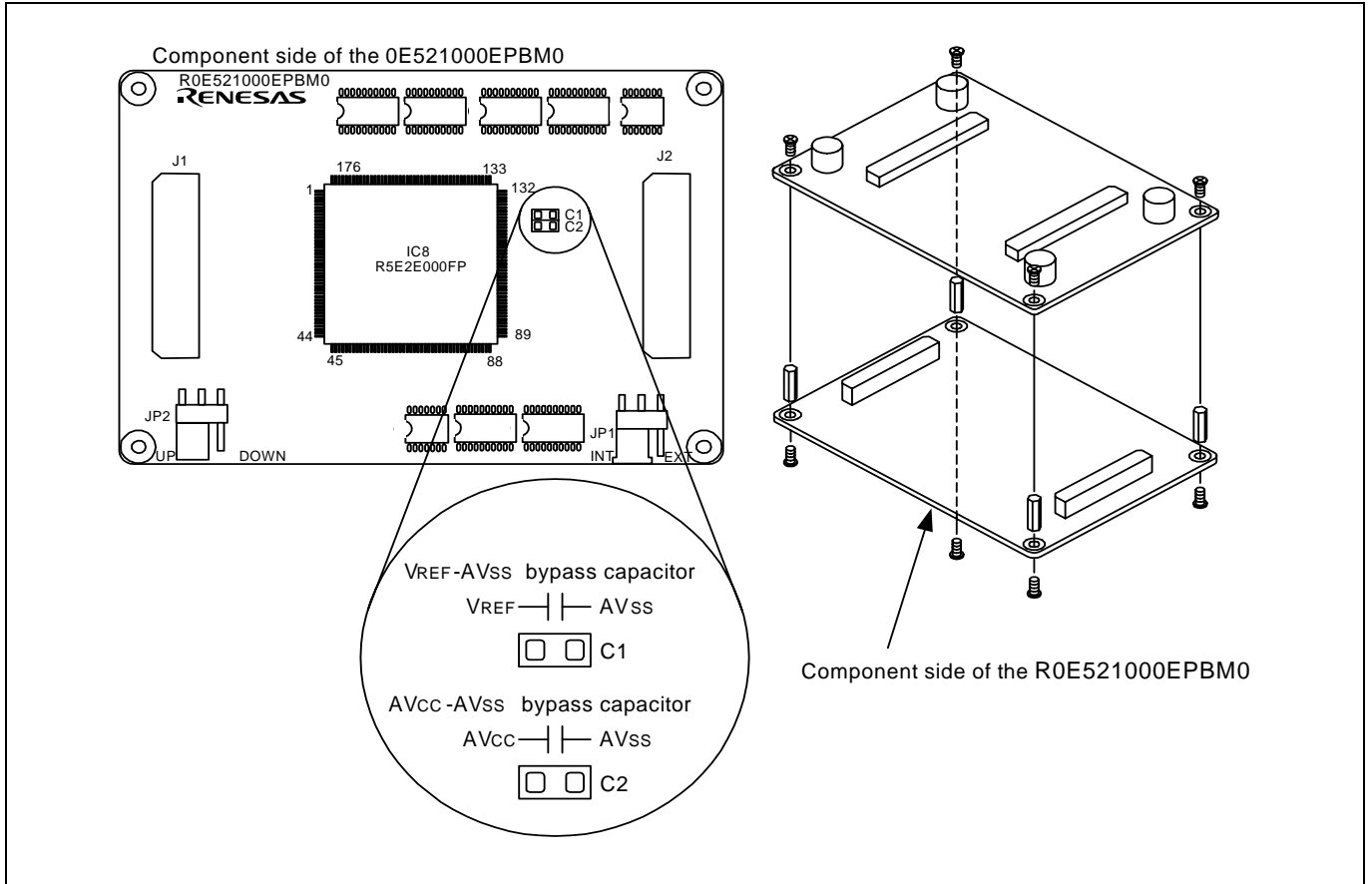

Figure 2.23 Foot pattern for the A/D conversion bypass capacitor and the configuration of this product

IMPORTANT

Note on the A/D Converter:

- Because a package converter board and other devices are used between the evaluation MCU and the user system, the A/D converter operates differently from an actual MCU. Make the final evaluation of the A/D converter using an actual MCU.

3. Usage (Emulator Debugger)

This chapter describes how to start up the emulator debugger from the High-performance Embedded Workshop and operate the major windows.

3.1 Starting Up the Emulator Debugger

When debugging the completed programs, switch the session. The session can be changed by the drop down list of the tool bar shown below.



You will have as many sessions created as the number of targets you selected when creating a project, so select the session that corresponds to the target to be connected from the drop-down list. To connect to the PC7501 + R8C emulation probe, select "SessionM16C_R8C_PC7501_Emulator."

3.1.1 INIT Dialog Box

After specifying the session, an Init dialog box to connect the target is displayed. The Init dialog box is used to set the items that need to be set when the emulator debugger starts up. The contents set in this dialog box remain effective the next time you start the debugger.

(1) MCU tab

1) Specifying the MCU file

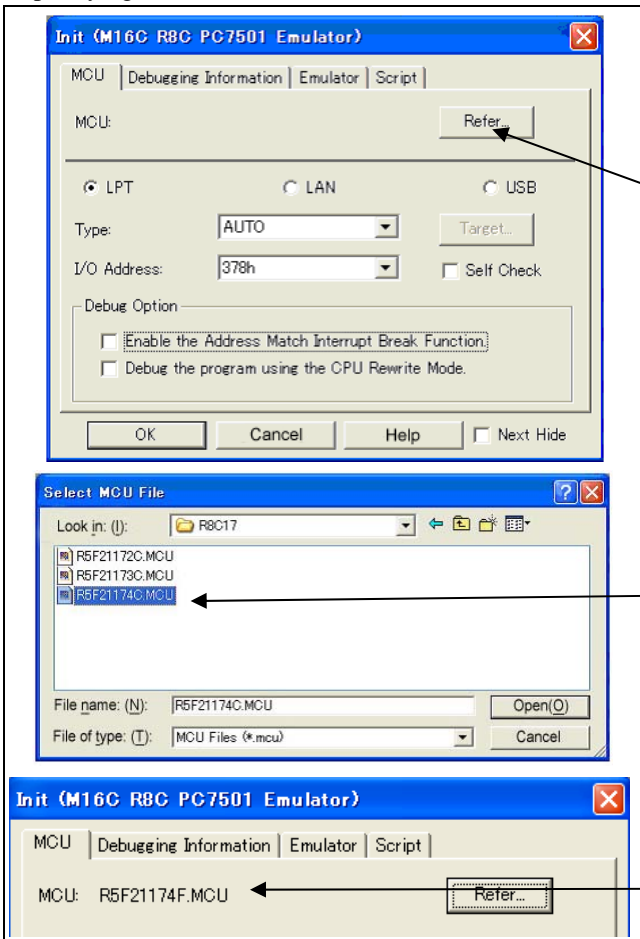

Specifying the MCU file
 A file selection dialog box will be displayed, so select the desired MCU file.
 - The MCU file contains the information specific to the target MCU.

(1) Click the "Refer..." Button.

(2) "Select MCU File" dialog box will be displayed. Specify the MCU file for the target MCU. (Here, an MCU for R8C/17 Group is selected)

The specified MCU file is displayed at the MCU area field of MCU tab.

2) Specifying the communication interface (LPT communication)

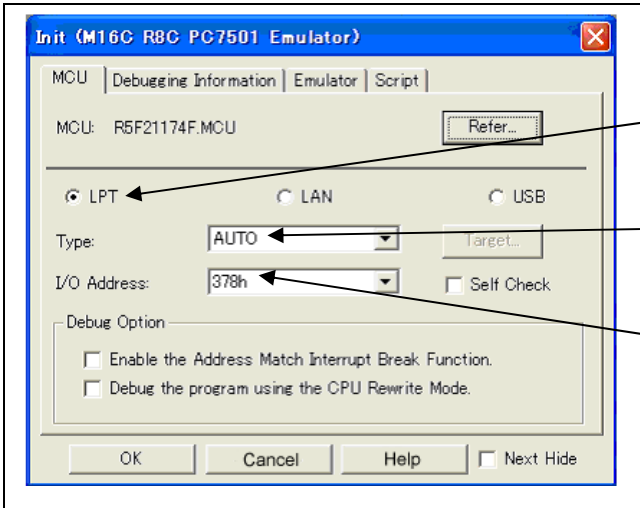

Specifying the communication interface (LPT communication)

- For selecting the LPT communication, click the radio button "LPT" of the MCU tab.
- For the Type area, specify the LPT interface communication mode to be used. **If this is the first time you are using the LPT communication, select "AUTO."**
- Specify the I/O address of the parallel port at the I/O address area. For BIOS setup, the following addresses are available.
 - 378h
 - 278h

3) Specifying the communication interface (LAN communication)

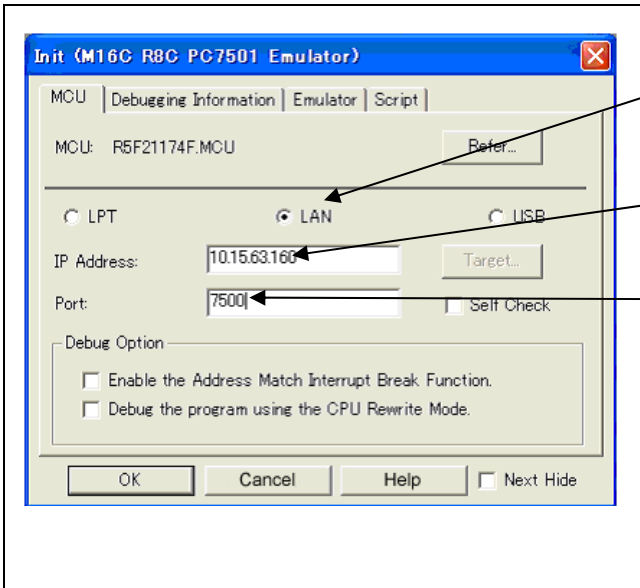

Specifying the communication interface (LAN communication)

- For selecting the LAN communication, click the radio button "LAN" of the MCU tab.
- Specify the IP address of the emulator at the IP address area. Specify the IP address by one byte of decimal number separating each four bytes with a period.
- Specify the port number at the Port area.

[Supplementary explanation]

When you are using LAN communication for the first time, connect to the emulator through other than LAN communication interface and set the IP address, or use the SETIP utility included with your product to set the IP address.

For details about the SETIP utility, refer to the on-line manual of your emulator debugger.

4) Specifying the communication interface (USB communication)

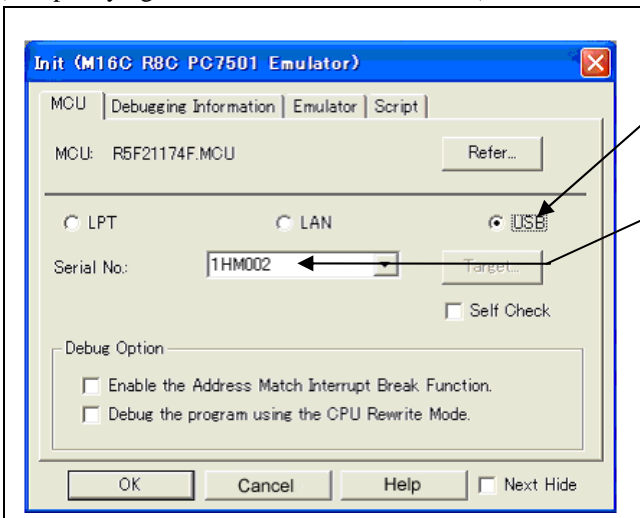

Specifying the communication interface (USB communication)

- For selecting the USB communication, click the radio button "USB" of the MCU tab
- The emulators connected by USB cable are shown at Serial No. area. Select the serial No. of the emulator you are going to connect.

[Supplementary explanation]

When you are using USB communication for the first time, you must install the USB driver first.

The USB devices are detected when you turn on the power for the emulator, and a wizard for installing the corresponding device driver will automatically be started. Follow the instructions of the wizard to complete installation.

5) Using or not using the Address Match Break and CPU rewrite mode

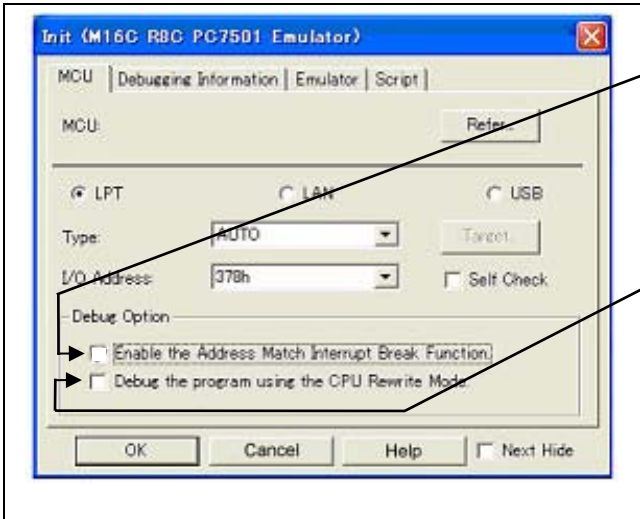

Using or not using the address match break function

Because the address match break function cannot be used with this product, be sure to deselect the box when you start up for the first time.

Using or not using CPU rewrite mode

Specify whether or not to debug in CPU rewrite mode. To debug the user program that uses CPU rewrite mode, select the check box. This option can be selected or deselected only when you are starting up the emulator debugger.

[Supplementary explanation]

When debugging in CPU rewrite mode is enabled, the following functions cannot be used while executing the user program:

- Software breakpoint setting in the internal ROM area
- Program or data rewrite operation to the internal ROM area
- Hardware break point and trace point settings

6) Executing the self-check

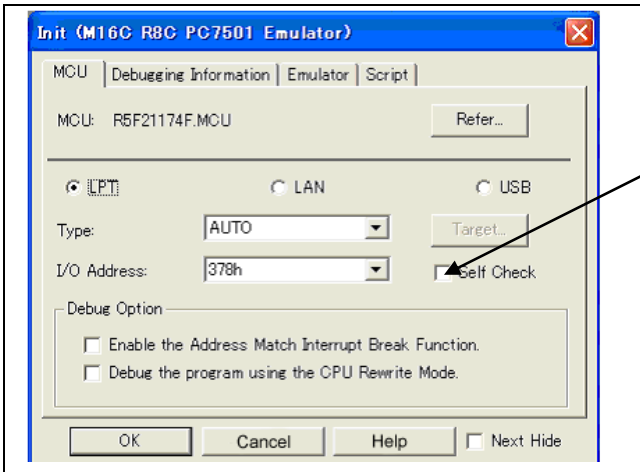

Executing the self-check

Enable this function when you want the emulator to be self-checked at startup. Be sure to select the check box only when you want the emulator to be self-checked at startup.

This function may be enabled in the following cases:

- When you are using the emulator you have just purchased
- When you successfully download the firmware, but fail to start up the emulator
- When you want to confirm whether the emulator is operating normally because, for example, the MCU runs out of control or something is wrong with the trace results

This function can be enabled only when you are starting up the emulator debugger.

(2) Debugging Information tab

1) Referencing the compiler used and the object format

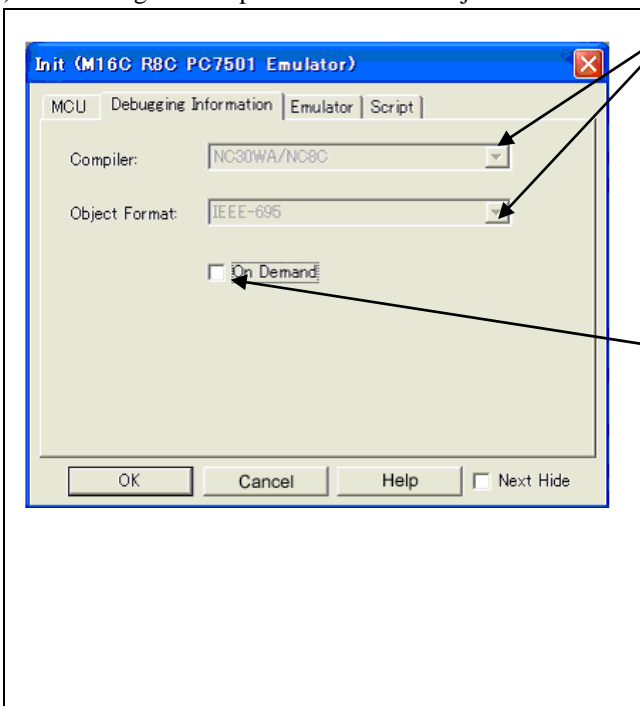

Referencing the compiler used and the object format

Reference the compiler you are using and the format of the object file output by the compiler.

[Supplementary explanation]

To alter this setting, use the dialog box that is brought up by selecting "Debug" and then "Debug Settings..." from the menu.

Specifying the method for storing debug information

There are two methods for storing debug information: on memory method and an on demand method.

Select the method for storing debug information.

(By default, the on memory is selected)

When selecting the on demand method, check the "On Demand" check box.

- On Memory

The debug information is stored in the memory of your computer. This method is suitable when the size of the load module (user program) is small.
- On Demand

The debug information is saved to a reusable temporary file. When you download the same load module for a second time on, the saved debug information will be reused and the load module can therefore be downloaded fast. This method is suitable when the size of the load module (user program) is large.

(3) Emulator tab

1) Specifying the target clock

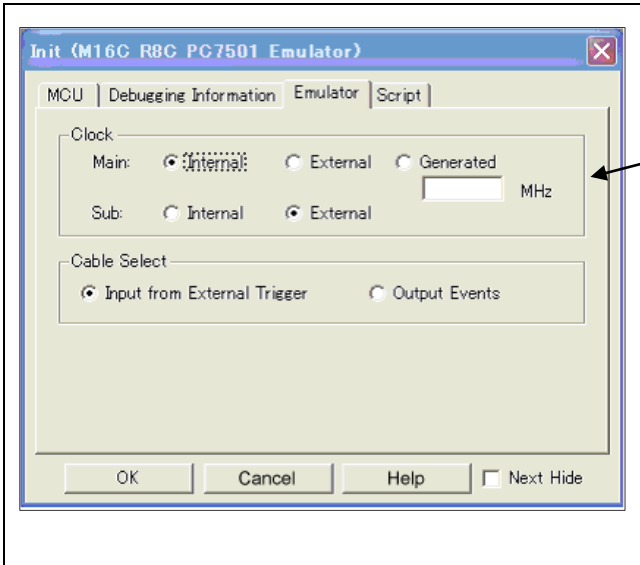

Specifying the target clock

Specify the clock sources supplied to the MCU (main clock and sub clock). Select the appropriate clock sources according to the clock used by your target MCU. If you use an on-chip oscillator, select "internal" for both main and sub clocks.

Main clock	Sub clock
Internal (default) Emulator PC7501's internal clock	Internal Emulator PC7501's internal clock
External User system clock	External (default) User system clock
Generated Clock created in PC7501	

The option you have specified here remains effective the next time you start up.

2) Selecting the event output/trigger input cable

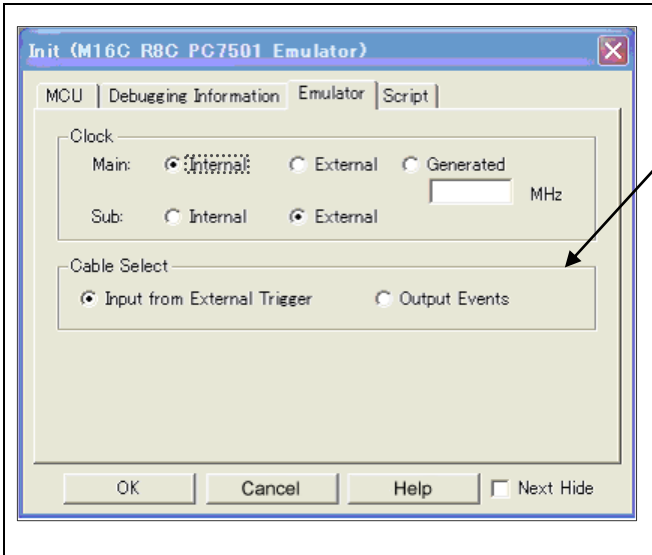

Selecting the event output/trigger input cable

Select input/output of the event output/trigger input cable of the PC7501.

- Input from External Trigger (default)
Inputs the external trigger from the cable
- Output Events
Outputs events from the cable

Note:

When the POWER selection jumper is switched to the EXT side, the upper limit of the external trigger input level (VI) is 3.6 [V]. Similarly, the upper limit of the event output level (Vo) is 0 to 3.3 [V].

The option you have specified here is reflected at only startup. However, if you reset the option in the Init dialog box after starting up, it is not effective (reboot the emulator debugger and reconnect the emulator.).

"Input from External Trigger" is set at startup (the previous setting becomes null).

(4) Script tab

1) Automatically executing a script command

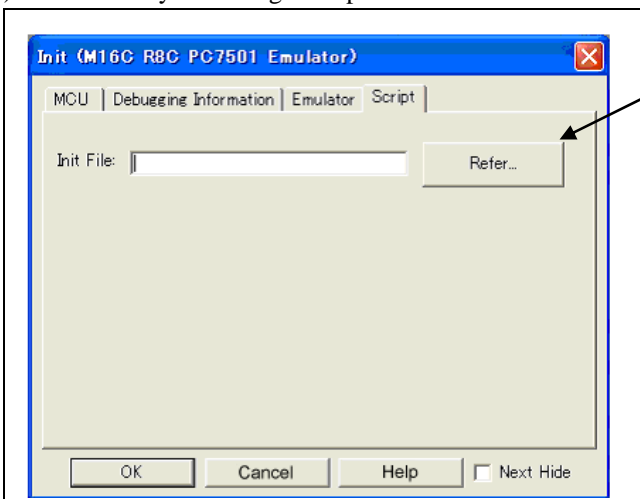

Automatically executing a script command

To automatically execute a script command when starting up the debugger, click the "Refer..." button and specify the script file to be executed.

Clicking the "Refer..." button brings up a file selection dialog box. The script file you have selected is displayed in the Init File: section of the dialog box shown here. If you do not want to automatically execute a script command, delete the character string displayed in the Init File: section of the dialog box.

What you specify here is reflected at only startup. If you specify back again in the Init dialog box after startup, whatever you specified has no effect. (Be sure to restart the emulator debugger.)

When the tab settings (1) to (4) above are completed, click OK button.

3.1.2 MCU Setting Dialog Box

MCU setting dialog box sets the information of the user system. It will be displayed after closing the Init dialog box.

(1) MCU tab

1) Specifying the processor mode

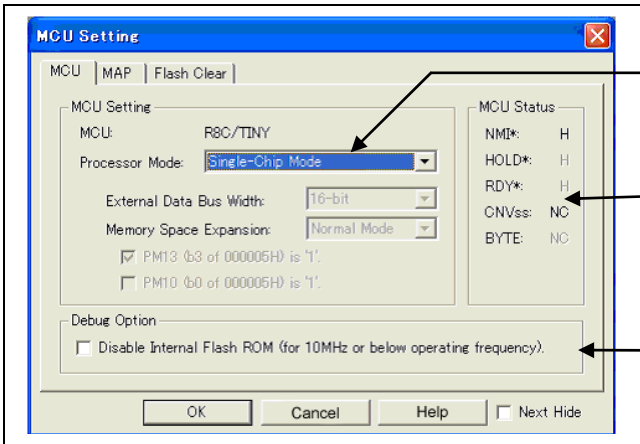

Specifying the processor mode

Select the appropriate processor mode that suits your system. For the R8C/Tiny Series, you can specify only the following processor mode.

- Single-chip Mode:

Referring to the MCU pin status

This column shows the state of each MCU pin. For the R8C/Tiny series, however, it does not show the MCU pin state.

Debug option setting

Optional settings are not used for the R8C/Tiny series. Always be sure to leave the check box for optional settings unselected.

(2) MAP tab

1) Specifying the emulation memory allocation

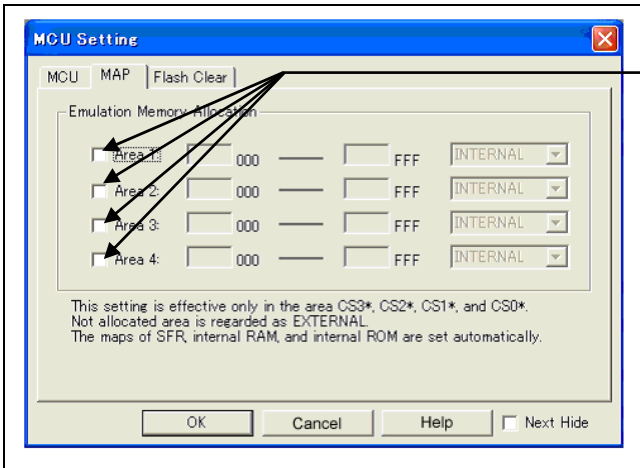

Specifying the emulation memory allocation

This tab is not used for R8C/Tiny.

Be sure to deselect the emulation memory allocation check boxes when using.

(3) Flash Clear tab

1) Setting to clear the MCUs' internal flash ROM

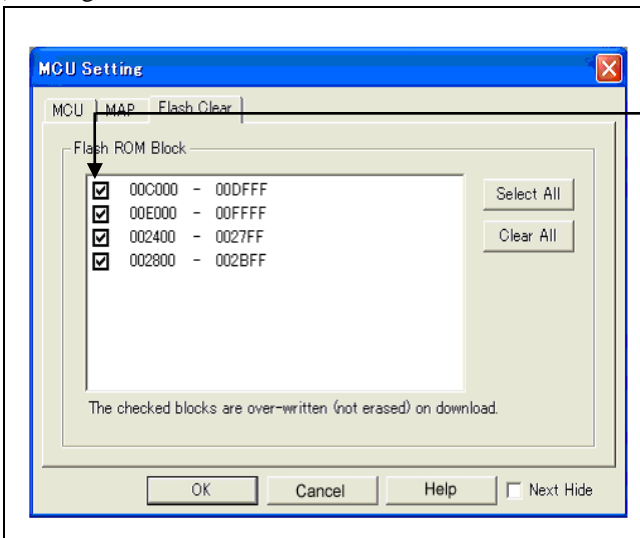

Setting to clear the MCU's internal flash ROM

Specify whether or not you want the MCU's internal flash ROM to be cleared when downloading the user program or data. (When cleared, the content of the flash ROM is initialized to 0xFF.) The MCU's internal flash ROM is listed in block units.

- Any block which has had its check box selected is not cleared when downloading. **Since the flash ROM in this product is cleared to 0x4h (NOP instruction) when the emulator starts up, the memory contents in the blocks that are not overwritten upon downloading are 0x4h (NOP instruction).**
- Any block which has had its check box deselected is cleared when downloading.
- Click the Select All button, or the Clear All button, all blocks will be selected or deselected

The option you have specified here remains effective the next time you start up.

When the tab settings (1) to (3) above are completed, click OK button.

3.1.3 Checking Connections of the Emulator System

Check to see that the emulator debugger has been connected correctly to the emulator.

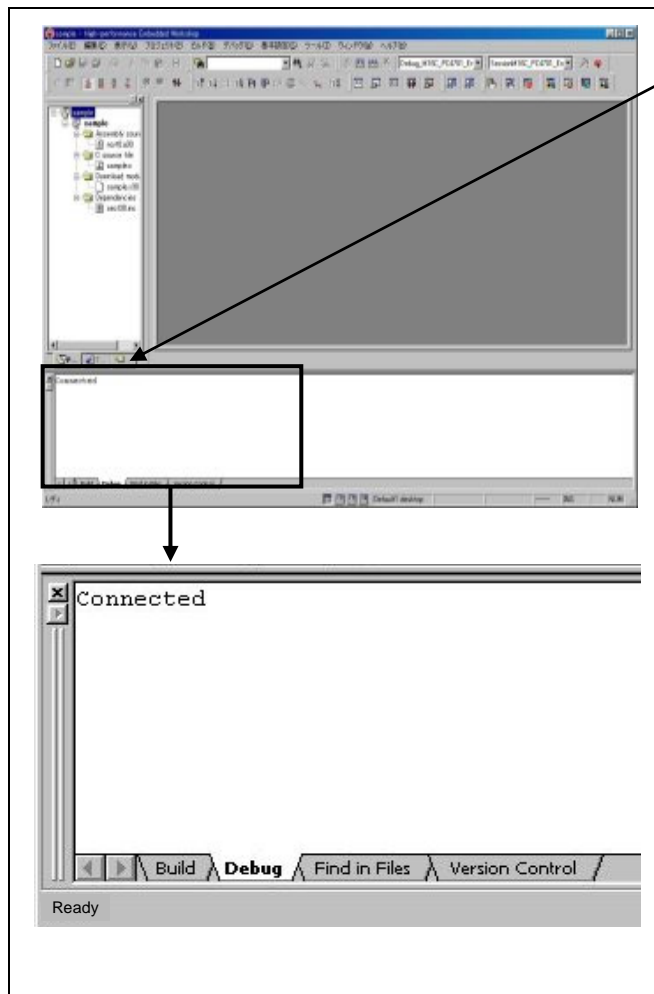

Checking connections of the emulator system

When the emulator debugger is connected correctly to the emulator after you've finished setting up the Init dialog box and the MCU Setting dialog box, you will see a message "Connected" displayed on the Debug tab of the Output window.

3.2 Downloading the Program

Downloading the program to be debugged.

1) Downloading from the work space window

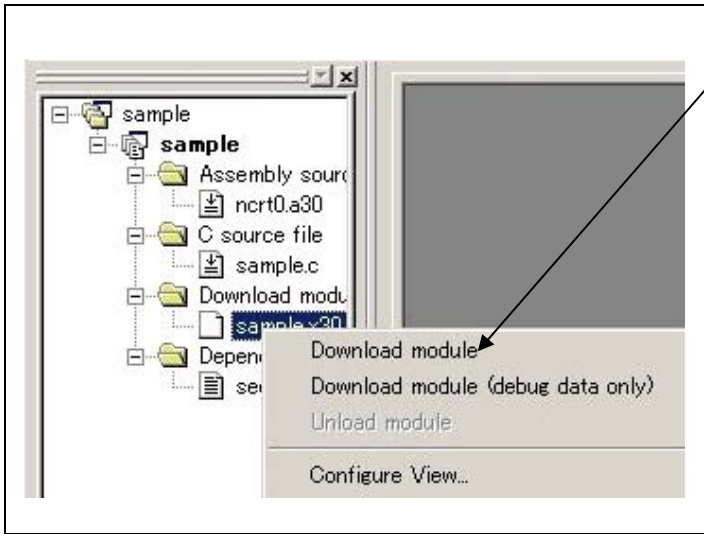

Downloading the program
Download the object program you want to debug.
Select Download from “xxx.x30” of “Download module”.
Or you can select “Download module” from the “Debug” menu for the same effect.

2) Showing the program

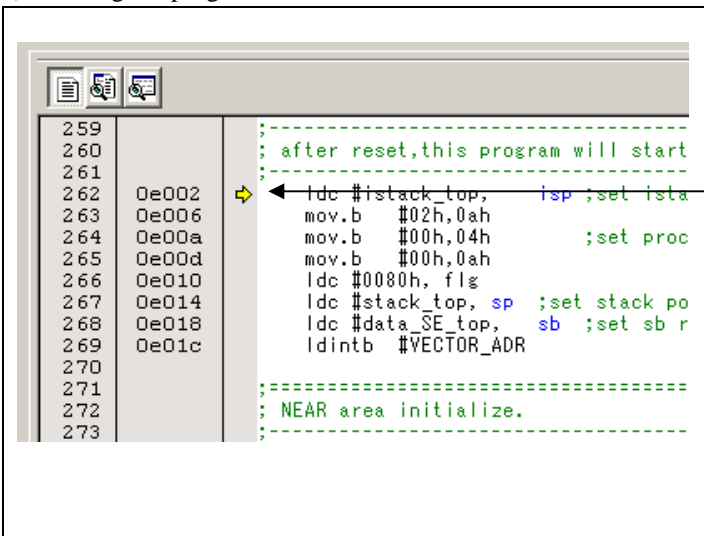

Editor (source) window
The editor (source) window is a window that always shows the content of the source file corresponding to the current position of the program counter (PC, hereafter).
The PC position is marked by a yellow arrow. Here, you can execute the program up to the cursor position, and set or clear software breakpoints.

3.3 Program Execution

(1) Program display



CPU reset

Resets the target MCU. You can select "CPU reset" from the "Debug" menu.

Go

Runs the program beginning with the current PC position. You can select "Go" from the "Debug" menu.

Reset Go

Runs the program after reset. You can select "Reset Go" from the "Debug" menu.

Step In

Single-steps the program executing each statement (including those in functions). You can select "Step In" from the "Debug" menu.

Step Over

Single-steps the program executing each function call as one step. You can select "Step Over" from the "Debug" menu.

Step Out

Exists a function and stops at a statement in the program next to the one that called the function. You can select "Step Out" from the "Debug" menu.

STOP

Stops the program. You can select "STOP" from the "Debug" menu.

Go Free

Runs the program beginning with the current PC position. The software and hardware breaks set in it are ignored.

(2) Setting software breakpoints

3) Setting and executing software breakpoint

```

259  ;-----;
260  ; after reset,this program will
261  ;-----;
262  0e002  →  ldc #istack_top,   isp ;set
263  0e006  mov.b #02h,0ah
264  0e00a  mov.b #00h,04h      ;set
265  0e00d  mov.b #00h,0ah
266  0e010  ldc #0080h, flg
267  0e014  ldc #stack_top, sp ;set sta
268  0e018  ldc #data_SE_top, sb ;set
269  0e01c  ldintb #VECTOR_ADR
270
271  ;-----;
272  ; NEAR area initialize.
273  ;-----;
    
```

Program execution with software breakpoint

- A software breakpoint can be set or cleared by double-clicking the software breakpoint display area in the editor (source) window (A red circle is displayed at the setting line).
-  Click the execution button.

Or you can select "Go" from "Debug" menu for the same effect.

4) Completing execution with software break

```

259  ;-----;
260  ; after reset,this program will
261  ;-----;
262  0e002  ldc #istack_top,   isp ;set
263  0e006  mov.b #02h,0ah
264  0e00a  mov.b #00h,04h      ;set
265  0e00d  mov.b #00h,0ah
266  0e010  ldc #0080h, flg
267  0e014  ldc #stack_top, sp ;set sta
268  0e018  ldc #data_SE_top, sb ;set
269  0e01c  ldintb #VECTOR_ADR
270
271  ;-----;
272  ; NEAR area initialize.
273  ;-----;
    
```

The cursor stops in the position where the software break was set up. The statement in which the software break was set up is not executed.

If the program is started to run from a PC position at which a software breakpoint is set, instructions at that PC position are stepped over automatically, and the program is executed from the next instruction on.

(3) Executing up to the cursor position (Come command)

1) Specifying the Come command

```

60      ;-----
61      ; Initialize Macro declaration
62      ;-----
63      N_BZERO .macro TOP_,SECT_
64      f0039      mov.b    #00H, R0L
65      f003a      mov.w    #(TOP_ & 0FFFFH), A1
66      f003d      mov.w    #sizeof SECT_ , R3
67      f0041      sstr.b
68      .endm
69
70      N_BCOPY .macro FROM_,TO_,SECT_
71      f0061      mov.w    #(FROM_ & 0FFFFH),A0
72      f0064      mov.b    #(FROM_ >>16),R1H
73      f0067      mov.w    #TO_ ,A1
74      f006a      mov.w    #sizeof SECT_ , R3
75      f006e      smovf.b
76      .endm
77
    
```

Setup procedure for executing COME command

- (1) Click the line in the editor (source) window at which you want the program to execute.
- (2)  Click the Come button.
Or you can select "Go to Cursor" from "Debug" menu for the same effect.

2) After the Come command has finished

```

60      ;-----
61      ; Initialize Macro declaration
62      ;-----
63      N_BZERO .macro TOP_,SECT_
64      f0039      mov.b    #00H, R0L
65      f003a      mov.w    #(TOP_ & 0FFFFH), A1
66      f003d      mov.w    #sizeof SECT_ , R3
67      f0041      sstr.b
68      .endm
69
70      N_BCOPY .macro FROM_,TO_,SECT_
71      f0061      mov.w    #(FROM_ & 0FFFFH),A0
72      f0064      mov.b    #(FROM_ >>16),R1H
73      f0067      mov.w    #TO_ ,A1
74      f006a      mov.w    #sizeof SECT_ , R3
75      f006e      smovf.b
76      .endm
77
    
```

The cursor stops in the position where the come command was executed.
The statement specified with the come command is not executed.

3.4 Hardware Breakpoint

Hardware break is set by event condition such as FETCH or DATA ACCESS, etc. If the breakpoint you set is a hardware breakpoint, the program stops after executing the instruction at the set breakpoint (after several cycles).

(1) Breakpoint setup dialog box

1) Opening the hardware breakpoint setup dialog box



Hardware Breakpoint
 Clicking this button opens the hardware breakpoint setup dialog box.
 Or you can select the "H/W break point (H)" of "Break (B)" from "View (V)" menu for the same effect.

2) H/W Break Point Setting Window

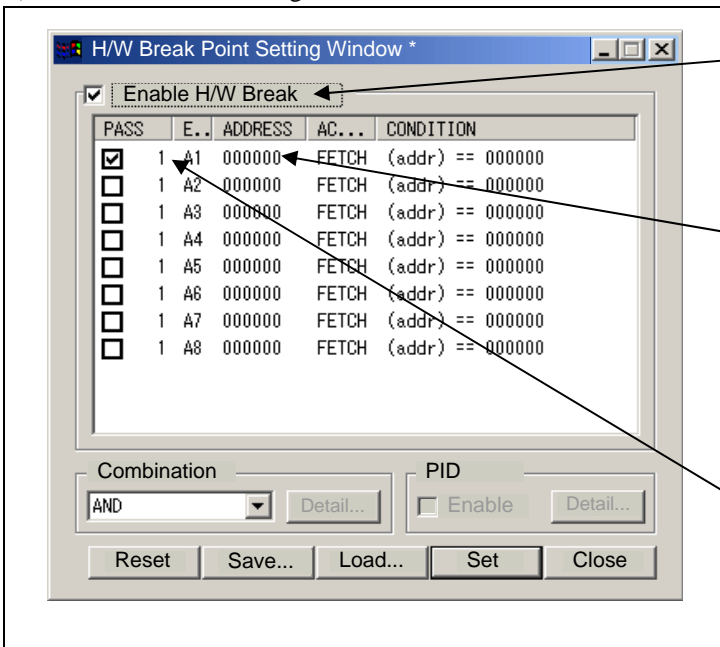

H/W Break Point Setting Window
 Select the "Enable H/W Break" check box, and this break function will be enabled, allowing you to set hardware breakpoints.

Setting Break Event
 Click the event line at which you want set a break event.

Setting Pass Count
 For each event, a pass count (number of passing) is specifiable (1--255). When "AND" (same time) is specified for Combination, you can not specify the pass count (fixed to one).

3) Opening the break event setting dialog box

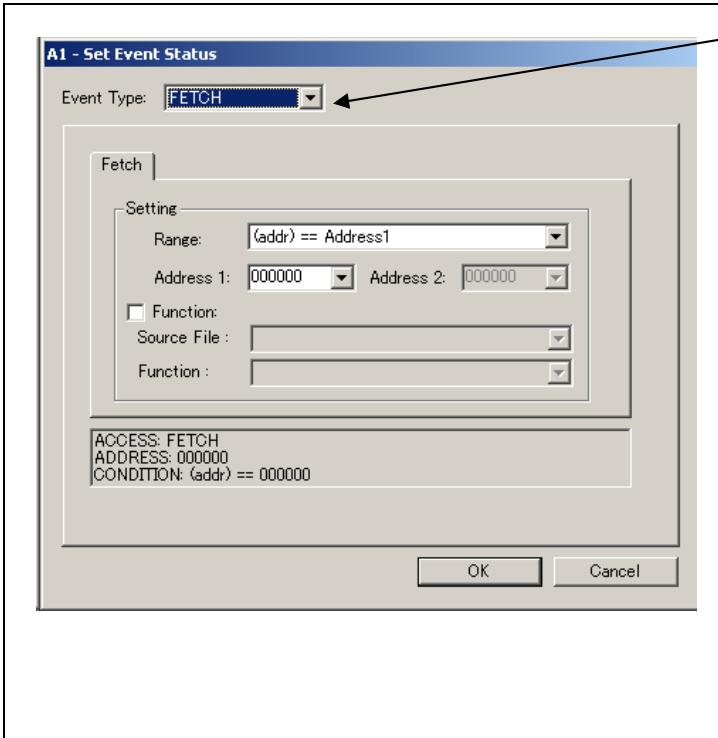

Specifying the event type

Click to select the event type you want to set.

- **FETCH**
Detects an instruction prefetch.
- **DATA ACCESS**
Detects a memory access.
- **BIT SYMBOL**
Detects a bit access.
- **INTERRUPT**
Detects an occurrence of interruption or interrupt completion.
- **TRIGGER**
Detects a signal from the external trace signal input cable.

(2) When FETCH is selected

1) Setting the address

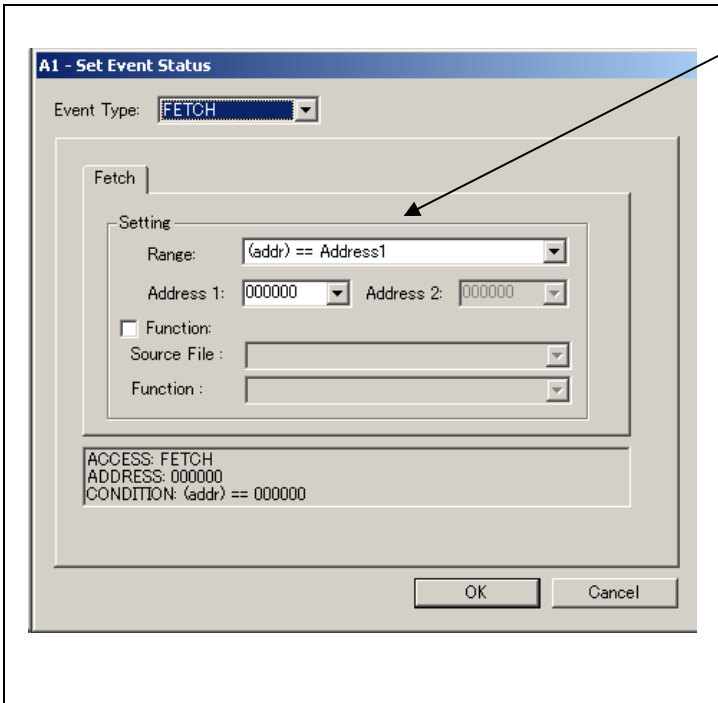

Setting the address

You can set eight conditions, e.g., a specified address, a specified address range, etc. When you have finished setting the address, click OK.

(3) When DATA ACCESS is selected

1) Setting the addresses

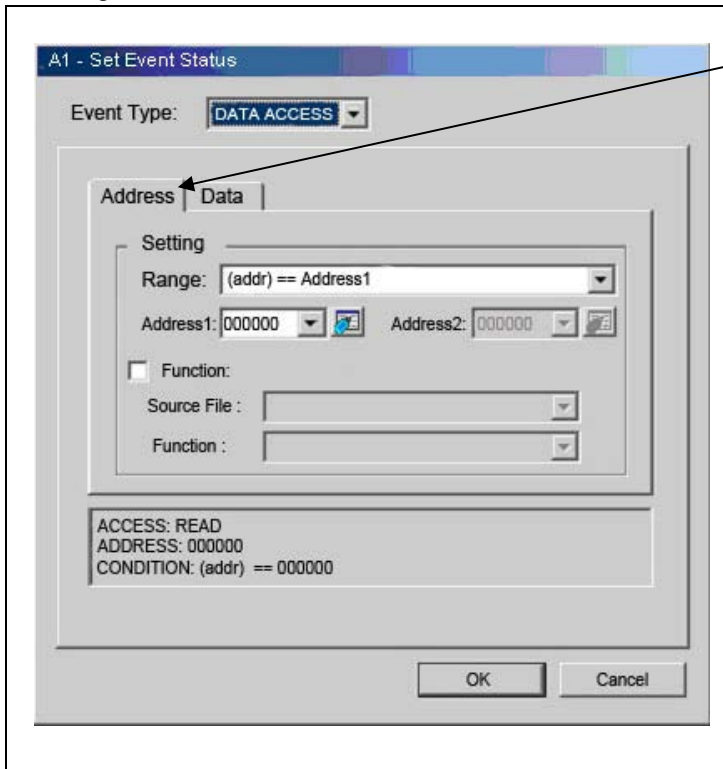

Setting the address
Specified in the Address tab. You can set eight conditions, e.g., a specified address, a specified address range, etc.
After the address setting completion, set the data.

2) Setting data

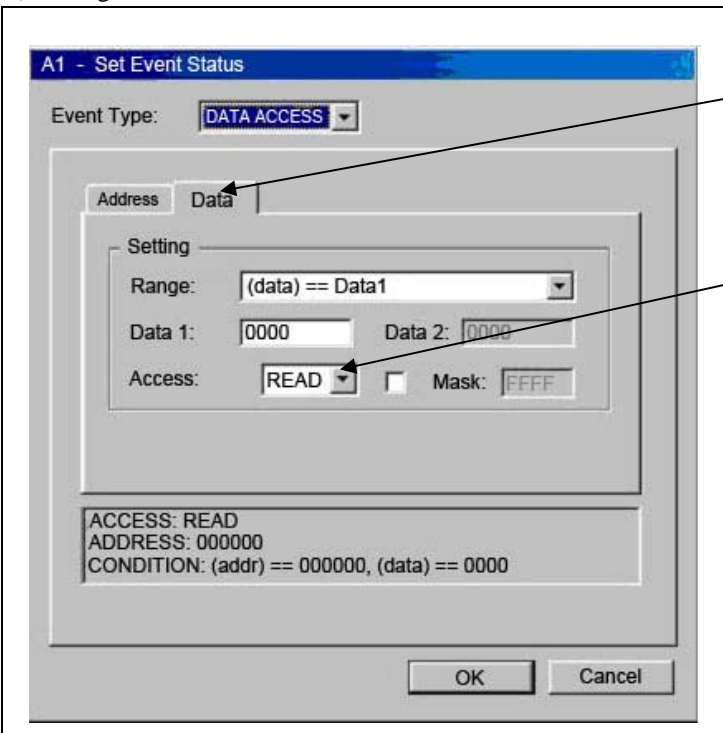

Setting data
Specified in the Data tab.
You can set eight conditions, e.g., specified data. specified data range, etc.
Setting the access condition
You can set three conditions, e.g., read, write, and read/write.
When you have finished setting the data and access condition, click OK.

3) Example Data Settings

Event setting for even-address word access (16-bit bus width)

STE.W A0,126h(A0=5423h)

Cycle	Label	Address	Data	BUS	BHE	BIU	R/W	RWT	CPU
-000012		000126	5423	16b	0	DW	W	0	--

16-bit bus width area (High-order and low-order data effective)

Setting a break event

A1
 Address 1 :000126
 Data 1 :5423
 MASK :FFFF
 Access :WRITE

Event setting for even-address word access (8-bit bus width)

STE.W A0,400h(A0=5423h)

Cycle	Label	Address	Data	BUS	BHE	BIU	R/W	RWT	CPU
-000013		000400	0023	8b	1	DW	W	0	--
-000012		000401	0054	8b	0	DW	W	0	--

8-bit bus width area (Only Low-order data effective)

Setting a break event

A1
 Address 1 :000400
 Data 1 :5423
 MASK :00FF
 Access :WRITE

Event setting for odd-address word access

STE.W A0,401h(A0=AB79h)

Cycle	Label	Address	Data	BUS	BHE	BIU	R/W	RWT	CPU
-000013		000401	0079	8b	0	DW	W	0	--
-000012		000402	00AB	8b	1	DW	W	0	--

8-bit bus width area (Only Low-order data effective)

Setting a break event (using 2 events)

A1	A2
Address 1 :000401	Address 1 :000402
Data 1 :0079	Data 1 :00AB
MASK :00FF	MASK :00FF
Access :WRITE	Access :WRITE

Set the combinatorial events to AND.

Event setting for even-address byte access

STE.B ROL,[A1A0](ROL=E5h,A1=0000h,A0=0402h)

Cycle	Label	Address	Data	BUS	BHE	BIU	R/W	RWT	CPU
-000013		000402	00E5	8b	1	DB	W	0	--

8-bit bus width area (Only Low-order data effective)

Setting a break event

A1
 Address 1 :000402
 Data 1 :00E5
 MASK :00FF
 Access :WRITE

Event setting for odd-address byte access

STE.B ROL,[A1A0](ROL=E6h,A1=0000h,A0=0403h)

Cycle	Label	Address	Data	BUS	BHE	BIU	R/W	RWT	CPU
-000013		000403	00E6	8b	0	DB	W	0	--

8-bit bus width area (Only Low-order data effective)

Setting a break event

A1
 Address 1 :000403
 Data 1 :00E6
 MASK :00FF
 Access :WRITE

(4) Setting the combinatorial event condition for the hardware breakpoint

1) Window for setting the combinatorial event condition

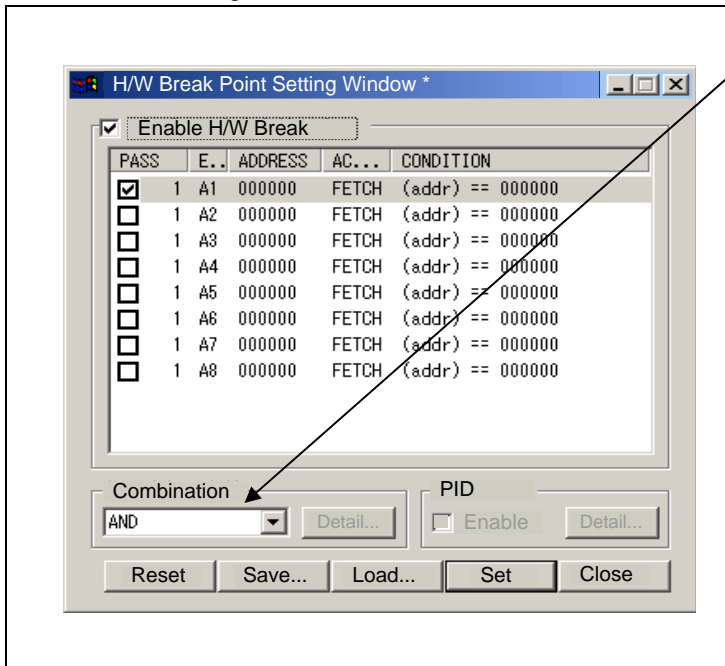

Setting the combinatorial event condition

There are following four conditions that you can choose for the combinatorial events.

- AND
The program breaks when all of the specified events occur.
- AND (Same Time)
The program breaks when the specified events occur at the same time.
- OR
The program breaks when one of the specified events occurs.
- STATE TRANSITION
The program breaks when the state transition diagram goes into the break state.

For each event, a pass count (number of passing) is specifiable (1--255). When "AND" (same time) is specified for Combination, you can not specify the pass count (fixed to one).

When you have finished setting the combinatorial event condition, click the "Set" button.

3.5 Trace Window

The trace window is used to show the results of real-time trace measurements.

(1) Trace window

1) Opening the trace window



Trace
 Clicking this button opens the trace window.

 Or you can select "Trace (T)" from "Trace (T)" of "View (V)" menu for the same effect.

2) Trace window

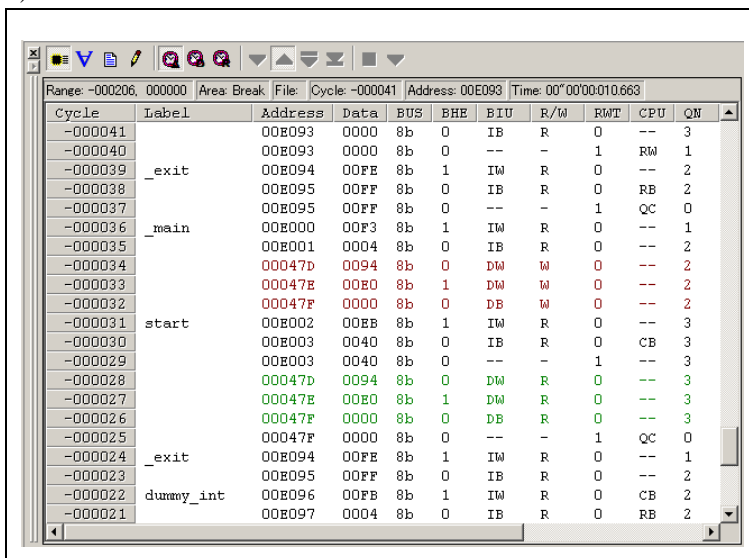

Trace window
 The trace window is used to show the results of real-time trace measurements. It has the following four display modes. Mixed mode can be displayed.

 The trace window shows the measurement result when a real-time trace measurement has finished. The trace window remains blank until the real-time trace measurement in progress finishes.

3) Trace display mode

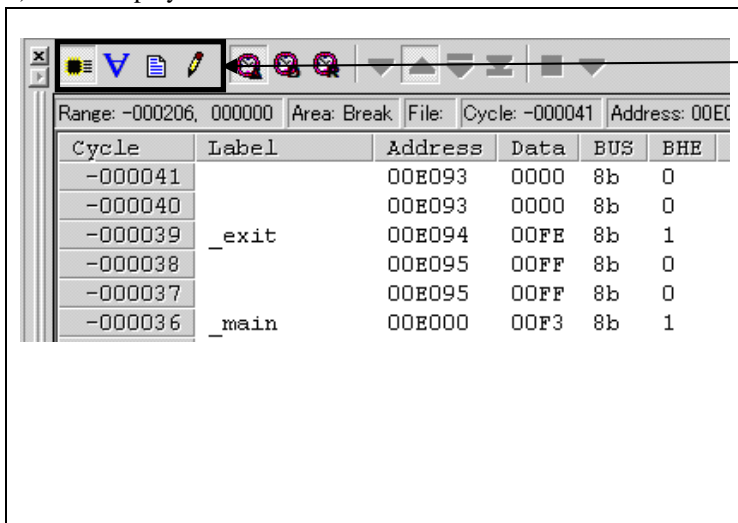

Trace display mode

- Bus mode
 Bus information per cycle can be inspected. The contents are displayed in order of execution paths.
- Disassemble mode
 The execution paths of the executed instructions can be inspected. The contents are displayed in order of execution paths.
- Source mode
 The execution paths of the source program can be inspected.
- Data access mode
 Data read/write cycles can be inspected. The contents are displayed in order of execution paths.

4) Trace window (Bus information display)

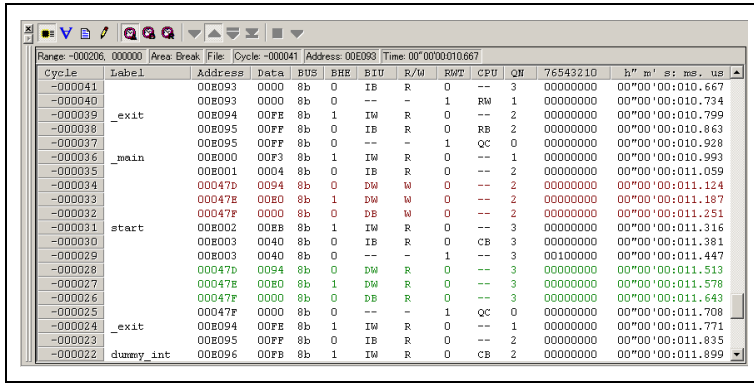

Explanation of the trace window (bus information display)

The following explains the displayed contents, from left to right.

- Address
Shows the status of the address bus.
- Data
Shows the status of the data bus.
- BUS
Shows the width of the internal data bus. For the R8C/Tiny series, only "8b" for 8 bits bus wide bus is displayed, excluding a part of the SFR area (00126h to 0012Fh, 00146h to 0014Fh and 00156h to 0015Fh)
- BHE
Shows the status (0 or 1) of the BHE (Byte High Enable) signal. If this signal = 0, the odd-address data is valid.
- BIU
Shows the status between the BIU (Bus Interface Unit) and memory or I/O.
- R/W
Shows the status of the data bus. Displayed as "R" for Read, "W" for Write, and "-" for no access.
- RWT
This is the signal to indicate a valid bus cycle. When valid, RWT = 0. The Address, Data, and the BIU signals are effective when this signal is 0.
- CPU
Shows the status between the CPU and BIU (Bus Interface Unit).
- QN
Shows the byte count stored in the instruction queue buffer. The display range is 0 to 4.
- 76543210
Shows the level of external trace signal input cable EXTIN0 to EXTIN7.
- h' m' s: ms. us
Shows the elapsed time after starting the user program.

5) Trace window (Disassemble display)

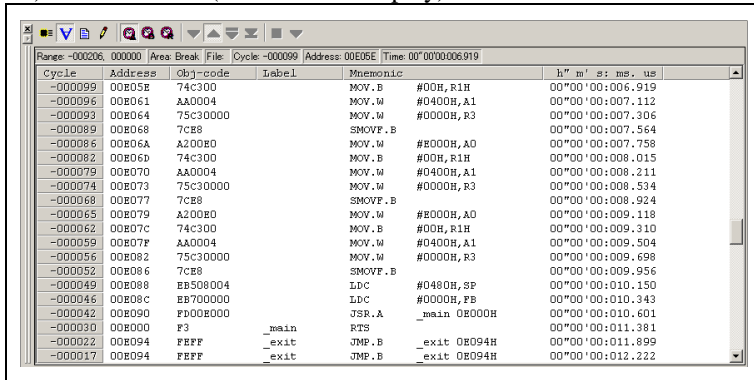

6) Trace window (Source display)

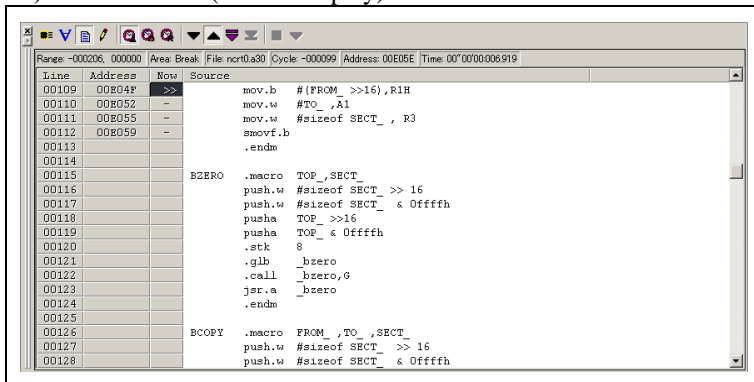

7) Trace window (Data access display)

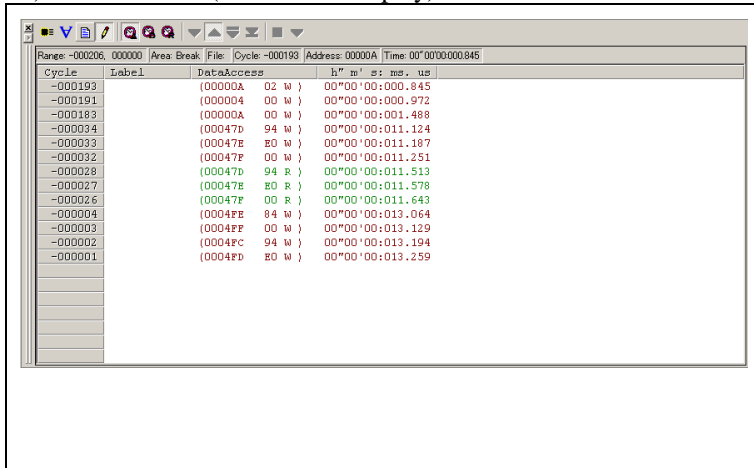

(2) Suspending and resuming trace measurement

1) Suspending trace measurement

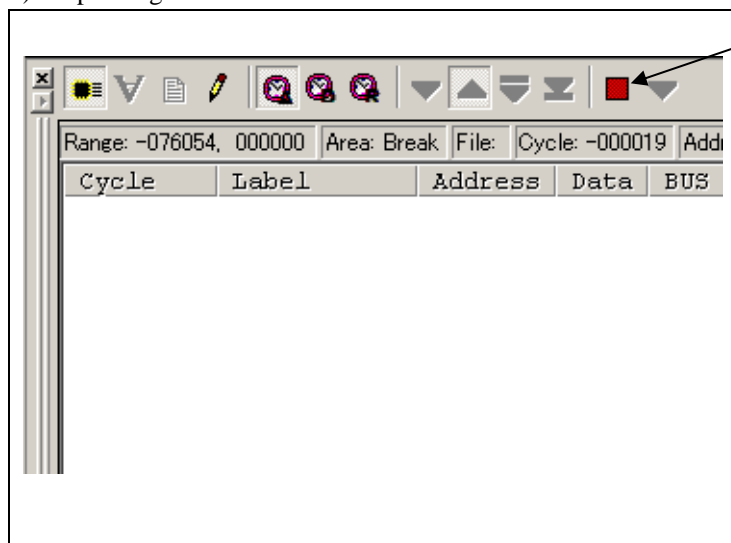

Stop
 Click this toolbar button to suspend the trace measurement in progress.

2) Resuming trace measurement

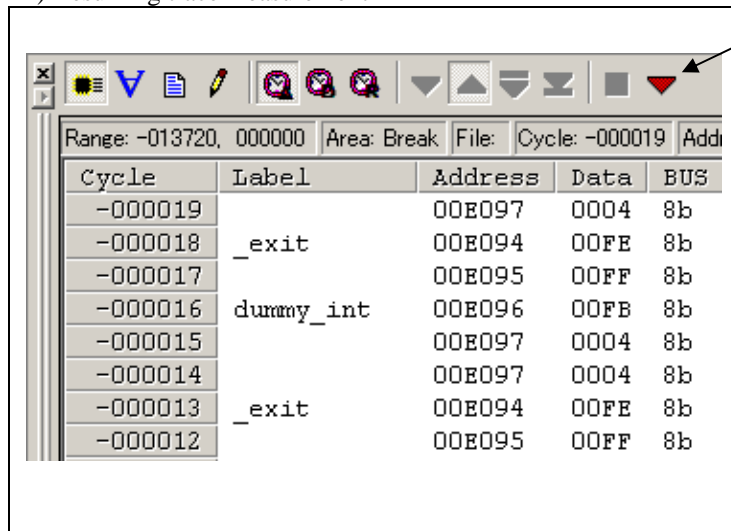

Re-Start
 Click this toolbar button to resume the trace measurement in progress.

(3) Trace point setup window

1) Opening the trace point setup window

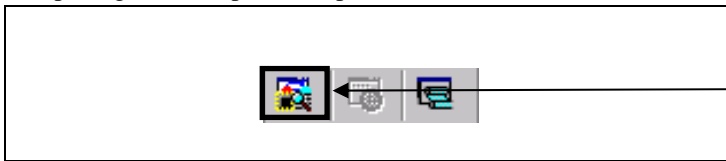

Trace Point
 Clicking this toolbar button opens the trace point setting window.
 Or you can select "Trace point (P)" from "Trace (T)" of "View (V)" menu for the same effect.

2) Trace Point Setting window

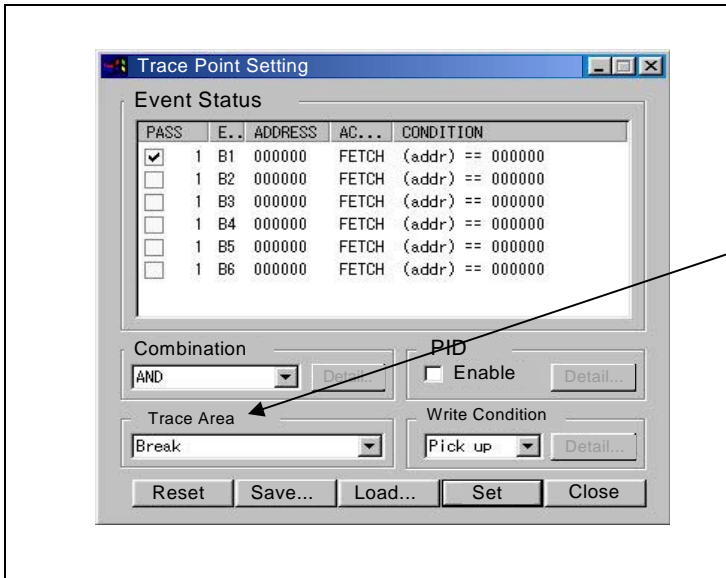

Trace Point setting window
 The trace point setup is the same for the hardware breakpoint setting.

Specifying a trace measurement area
 You can specify a trace range for the trace event.

- Break
 256K cycles of instruction execution before the user program stopped is recorded.
- Before
 256K cycles of instruction execution before a trace point condition was met is recorded.
- About
 128K cycles of instruction execution before and after a trace point condition was met is recorded.
- After
 256K cycles of instruction execution after a trace point condition was met is recorded.
- Full
 256K cycles of instruction execution after a trace began is recorded.

3) Setting trace write conditions

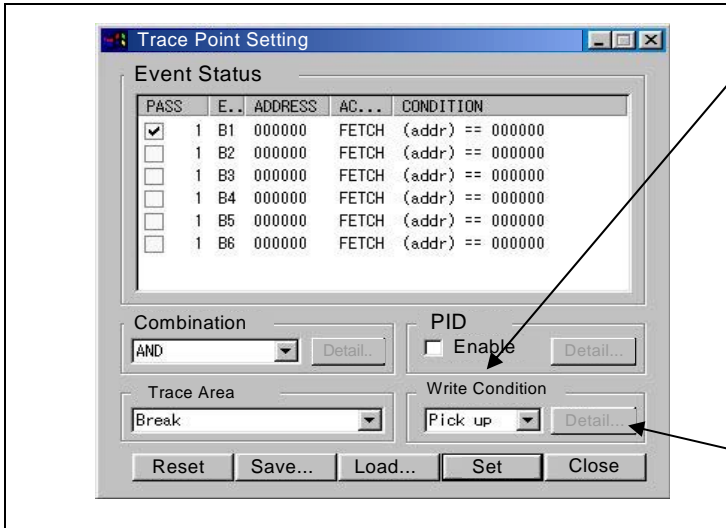

Setting trace write conditions
 You can specify a condition for the cycles to be written into the trace memory.

- Total
 All cycles are written into memory.
- Pick up
 Only the cycles in which the specified condition was met are written into memory.
- Exclude
 Only the cycles in which the specified condition was not met are written into memory.

When you have finished setting the trace write condition, click this button. The Realtime-trace Write Condition dialog box shown below will appear.

4) Realtime trace Write Condition dialog box

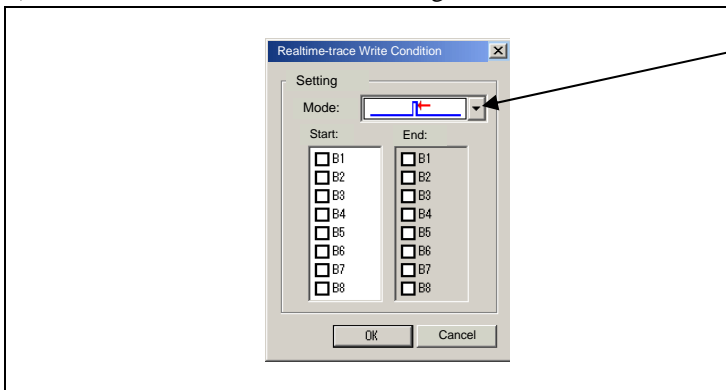

Write mode

Only the cycle in which the specified Start event occurred

A range of cycles from when the specified Start event occurred to when the specified Start event became nonexistent

A range of cycles from when the specified Start event occurred to when the specified End event occurred

3.6 RAM Monitor Window

This function makes it possible to make reference to the changes in memory contents without impairing the real-time performance for user program execution. The emulator PC7501 system is provided with the 4K-byte RAM monitoring area, which can be arranged in the 4K-byte space from any continuous address, or can be divided into 16 blocks in terms of 256 bytes.

(1) RAM monitor window

1) Opening the RAM monitor window



RAM monitor
 Clicking this button opens the RAM monitor window.
 Or you can select "RAM Monitor (R)" from "CPU (C)" of "View (V)" menu for the same effect.

2) RAM monitor display area

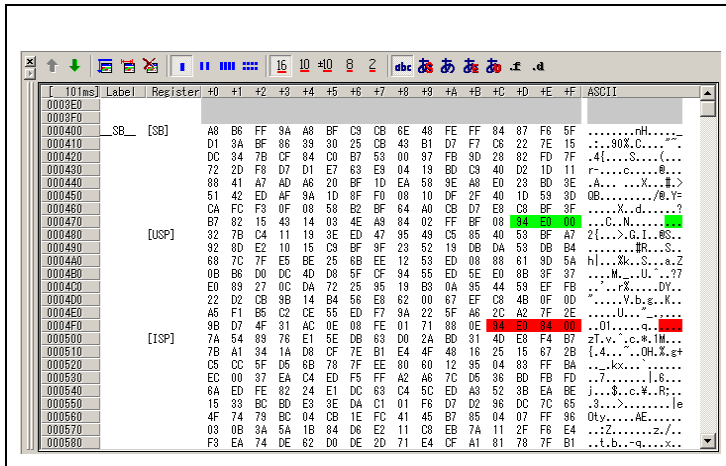

Changing the RAM monitor display area
 This window shows changes of memory contents while the user program is executed. This is accomplished by using the real-time RAM monitor function, and the memory contents corresponding to the RAM monitor area are displayed in dump form. The memory contents displayed here are updated at given intervals (by default, every 100 ms) during user program execution.

The background colors of the data display and the code display sections change with the access attribute as described below.

- Green : Addresses accessed for read
- Red : Addresses accessed for write
- White : Addresses not accessed

The background colors can be changed as necessary.

(2) Modifying the RAM monitor display area

1) RAM Monitor window

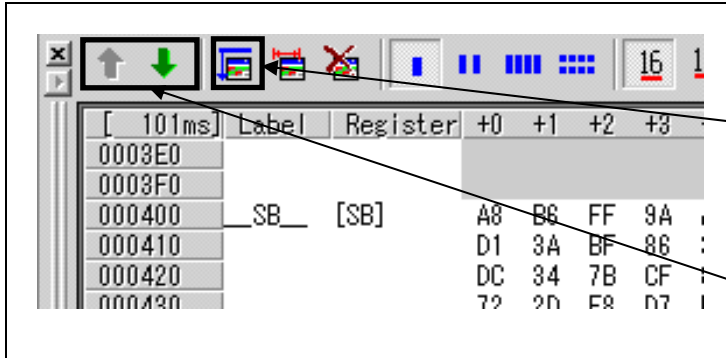



Modifying the RAM monitor display area

Clicking this button opens the RAM monitor setting window.

 : Shows the RAM monitor area setting window.

To change the displayed area, click the following buttons.

 : Shows the blocks at the preceding addresses.
 : Shows the blocks at the following addresses.

2) RAM monitor area setting window

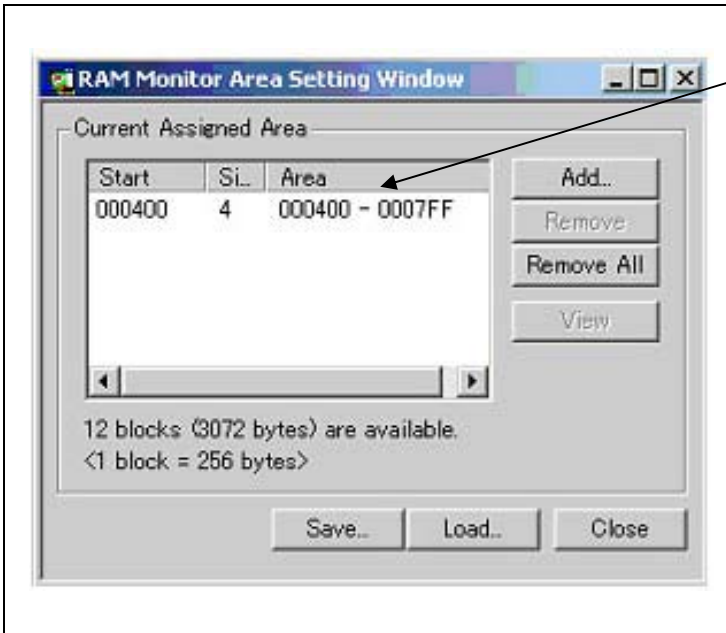

RAM Monitor area setting window

By default, the monitor area is set to 000400h through 0007FFh. It is possible to add, delete and change the RAM monitor area. You can change the start address, size (number of blocks) of the RAM monitor area by selecting the desired RAM monitor area from the list.

To add a RAM monitor area, click the "Add..." button. The RAM Monitor Area Setting Window will be displayed.

3) RAM monitor area setting dialog box

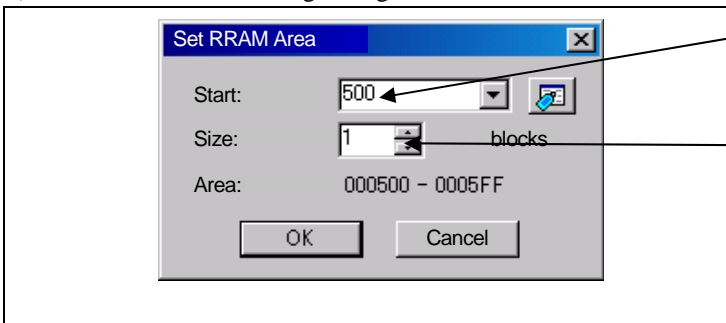

Specifying the start address

You can set the start address of the RAM area to be monitored.

Specifying the size

You can set the size to be monitored by specifying the number of blocks from the start address. One block is 256 bytes in size.

4. Hardware Specifications

This chapter describes specifications of this product.

4.1 Target MCU Specifications

Table 4.1 lists the specifications of target MCUs which can be debugged with this product.

Table 4.1 Specifications of target MCUs for the R0E521000EPB00

Item	Description
Applicable MCU	R8C/Tiny Series
Applicable MCU mode	Single-chip mode
Maxi. ROM/RAM capacity	1. Internal flash ROM: 112KB (programming area) +4KB (data area) Program: 04000h--1FFFFh, Data: 02000h--02FFFh 2. Internal RAM: 8KB 00300h--012FFh, 03000h--03FFFh
Operating voltage/frequency	20MHz at 3.0--5.5V 10MHz at 2.7--5.5V 5MHz at 2.2--5.5V ^{*1}

*1 If the system is used with power supply voltages less than 2.7V, change the JP1 setting of the R0E521000EPB00 to the EXT side. For details, see “2.10.2 Setting the POWER Selection Jumper” (page 39).

4.2 Differences between the Actual MCU and Emulator

Differences between the actual MCU and emulator are shown below. When debugging the MCU using this product, be careful about the following precautions.

IMPORTANT

Notes on Internal Memory (ROM and RAM):

- The evaluation MCU mounted on this product has the emulation memory for RAM area of 8 KB (00300h--012FFh, 03000h--03FFFh) and flash ROM area of 4 KB (02000h--02FFFh) and 112 KB (04000h--1FFFFh). For this reason, the nonexistent ROM or RAM area of the target MCU may be accessed.
- With this product, the flash ROM area of target MCU is cleared at "04h (NOP instruction)" when starting up the emulator. If you want the MCU's internal flash ROM to be cleared when starting up the debugger, (when cleared, the content of the flash ROM is initialized to 0FFh.), select the flash ROM block you want to clear in the Flash Clear tab of the MCU setting dialog box.

Note on Access Prohibited Area:

- You cannot use internally reserved areas. Because an evaluation MCU is operated in the special mode for the emulator, a function which does not support the target MCU may run.

Notes on RESET# Input:

- A low input to pin RESET# from the user system is accepted only when a user program is being executed (when the RUN status LED on the emulator's upper panel is lit).
- The time for starting up (0.2 VCC to 0.8 VCC) and falling edge (0.8 VCC to 0.2 VCC) for RESET# pin should be set to 1μs or less.

Note on Power-on Reset Function:

- This product emulates inputs to the RESET# pin for the purpose of emulator function control. For this reason, the power-on reset function cannot be used.

Notes on Maskable Interrupts:

- Even if a user program is not being executed (including when run-time debugging is being performed), the evaluation MCU keeps running so as to control the emulation probe. Therefore, timers and other components do not stop running. If a maskable interrupt is requested when the user program is not being executed (including when run-time debugging is being performed), the maskable interrupt request cannot be accepted, because the emulator disables interrupts. The interrupt request is accepted immediately after the user program execution is started.
- Take note that when the user program is not being executed (including when run-time debugging is being performed), a peripheral I/O interruption is not accepted.

Notes on Oscillator Circuit:

- Make note of the fact that in the oscillator circuit where a resonator is connected between pins P4_6/XIN and P4_7/XOUT, oscillation does not occur because a converter board and other devices are used between the evaluation MCU and the user system. It is same for a sub-clock oscillator (P4_3/XCIN and P4_4/XCOUT).
- For notes on when using the oscillator circuit on the user system, refer to "2.10.3 Selecting Clock Supply" (page 40).

Note on the pin P4_4/XCOUT:

- Make note that the pin P4_4/XCOUT of the evaluation MCU used for this product has no XCOUT output function.

IMPORTANT

Note on A/D Converter Function:

- Because a converter board and other devices are used between the evaluation MCU and the user system, the A/D converter operates differently from that of an actual MCU.

Notes on Stack Area:

- With this product, the interrupt stack pointer (ISP) is set at 00500h and used as a stack area after a reset is released.
- With this product, a maximum 8 bytes of the interrupt stack is consumed as a work area. Therefore, ensure the +8 byte maximum capacity used by the user program as the interrupt stack area.
Even if the interrupt stack does not have an enough area, do not access areas which cannot be used as a stack (SFR area, RAM area which stores data, or ROM area) as a work area. Accessing these areas like this is a cause of user program crashes and destabilized emulator control.

Note on Accessing Addresses 00000h and 00001h:

- With the R8C/Tiny Series MCUs, when a maskable interrupt is generated, the interrupt data (interrupt number and interrupt request level) stored in addresses 00000h and 00001h is read out. Also, the interrupt request bit is cleared when address 00000h or 00001h is read out. Consequently, when the address 00000h or 00001h readout instruction is executed or when address 00000h or 00001h is read out in the cause of a program runaway, a malfunction occurs in that the interrupt is not executed despite the interrupt request, because the request bit of the highest priority interrupt factor enabled is cleared.
With this product, when the reading out to the addresses 00000h or 00001h is generated excluding the interrupt, the yellow LED lights up to alarm. When this LED lights, there is a possibility of wrong access to addresses 00000h and 00001h, therefore check the program.

Note on Watchdog Timer:

- Although this product emulates the watchdog timer function of the target MCU, note that the count value does not always match that of the actual MCU. For this reason, when the program is single-stepped successively as in the case of overstep operation, a watchdog timer interrupt may be generated.

Note on the block 0 rewrite disabled bit (FMR15) and block 1 rewrite disabled bit (FMR16):

- The functions associated with bit 5 (FMR15) and bit 6 (FMR16) of Flash Memory Control Register 1 (FMR1 at address 001B5h) cannot be used. When writing to FMR15 and FMR16, always be sure to write a 0. These bits read as 0 when read out.

Note on Final Evaluation:

- Be sure to evaluate your system and make final confirmation with an actual MCU.

4.3 Connection Diagrams

4.3.1 Connection diagram of R0E521000EPB00

Figure 4.1 shows the part of the connection diagram of the R0E521000EPB00. This connection diagram mainly shows the interface section. The circuits not connected to the user system such as the emulator's control system are omitted. The signals not shown in Figure 4.1 connect the evaluation MCU and the user system directly. Table 4.2 shows IC electric characteristics of this product for reference purposes.

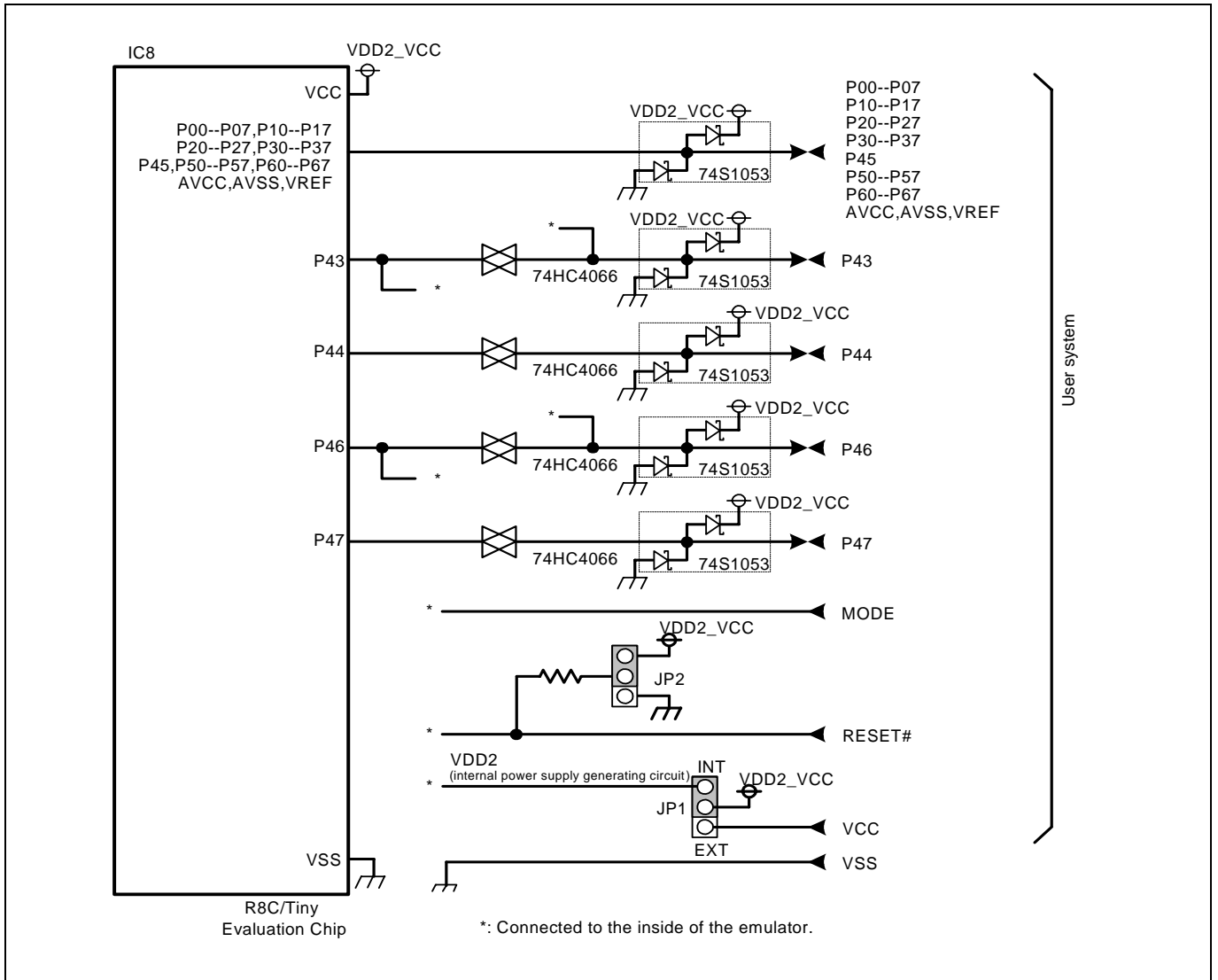

Figure 4.1 Connection diagram of R0E521000EPB00 (partly)

Table 4.2 Electrical characteristics of 74HC4066

Symbol	Item	Condition	Standard values			Unit
			VCC	Min.	Standard	
R _{ON}	ON resistor	4.5	-	96	200	Ω
ΔR _{ON}	ON resistor difference	4.5	-	10	-	
I _{OFF}	Leak current (Off)	12.0	-	-	±1	μA
I _{IN}	Leak current (On, output: open)	12.0	-	-	±1	

4.3.2 Connection diagram of R0E5212BACFG00, R0E5212BACFK00 and R0E5212DACFK00

Figure 4.2 shows the connection diagrams of the R0E5212BACFG00, R0E5212BACFK00 and R0E5212DACFK00. These connection diagrams mainly show the interface section. The circuits not connected to the user system such as the emulator's control system are omitted.

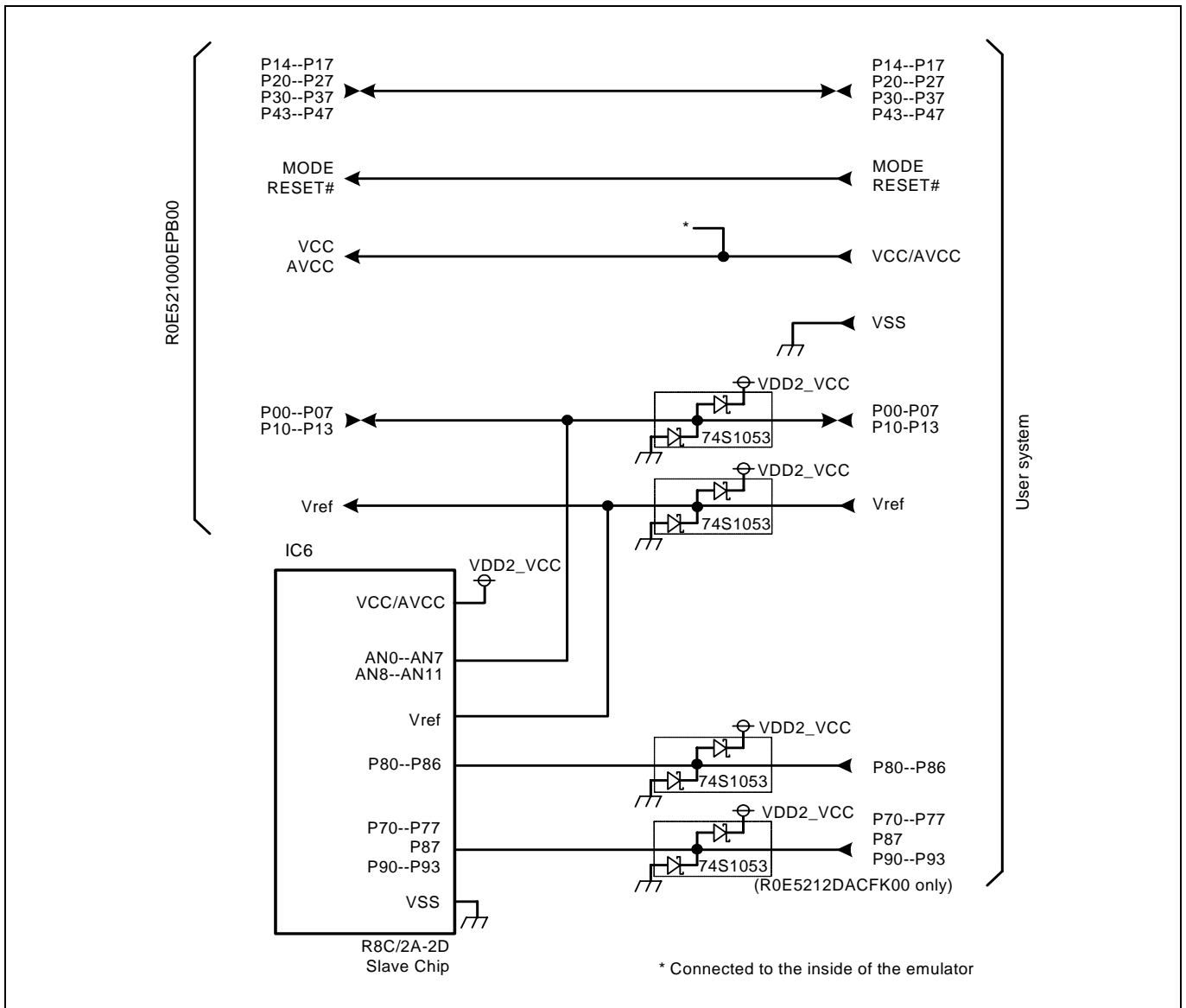

Figure 4.2 Connection diagrams of R0E5212BACFG00, R0E5212BACFK00 and R0E5212DACFK00 (partly)

4.4.2 External Dimensions of the Converter Board R0E521134CFG00

Figure 4.4 shows external dimensions and a sample foot pattern of the converter board R0E521134CFG00 (included with the R0E521134EPB00) for a 32-pin 0.8mm pitch LQFP.

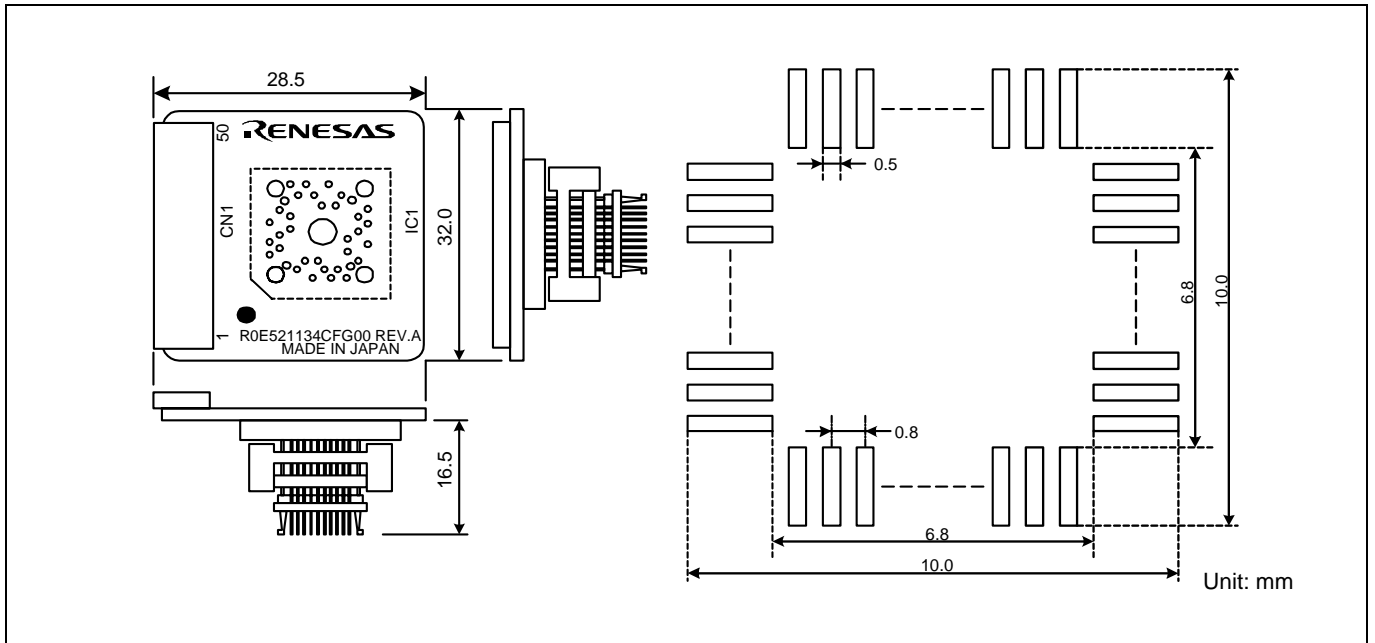

Figure 4.4 External dimensions and a sample foot pattern of the R0E521134CFG00

4.4.3 External Dimensions of the Converter Board R0E521174CSJ00

Figure 4.5 shows external dimensions and a sample foot pattern of the converter board R0E521174CSJ00 (included with the R0E521174EPB00) for a 20-pin 0.65mm pitch LSSOP.

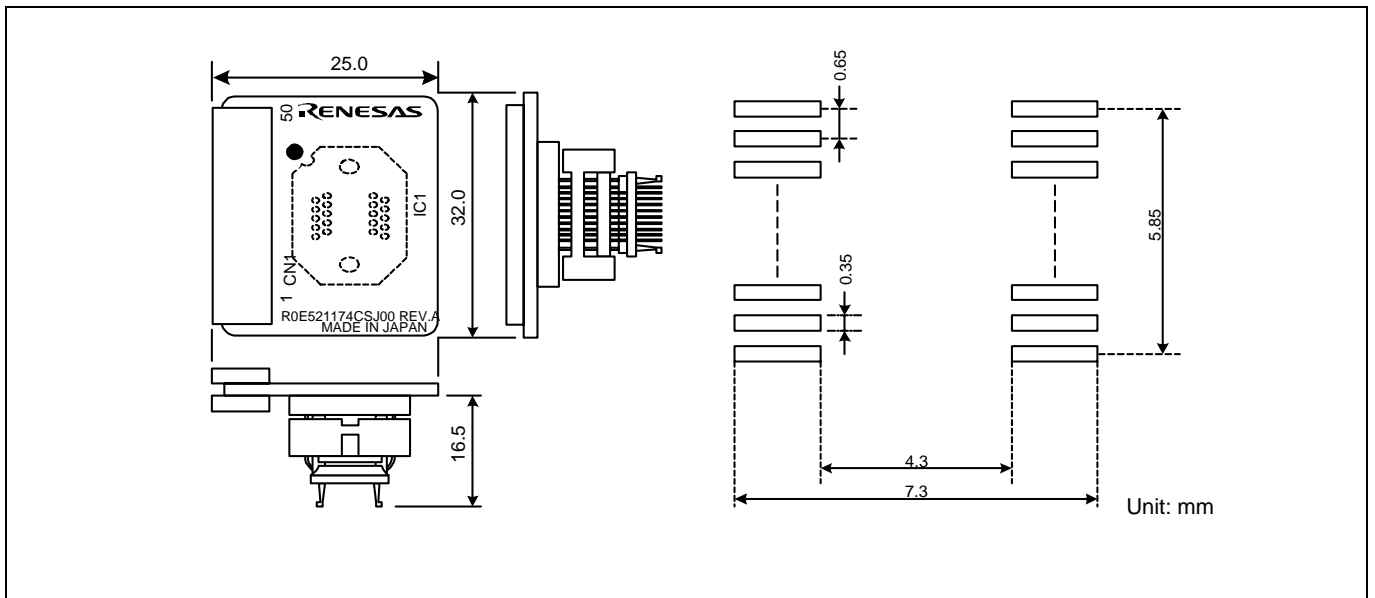

Figure 4.5 External dimensions and a sample foot pattern of the R0E521174CSJ00

4.4.4 External Dimensions of the Converter Board R0E521174CDB00

Figure 4.6 shows external dimensions and a sample foot pattern of the converter board R0E521174CDB00 (included with the R0E521174EPB10) for a 20-pin 1.778mm pitch SDIP.

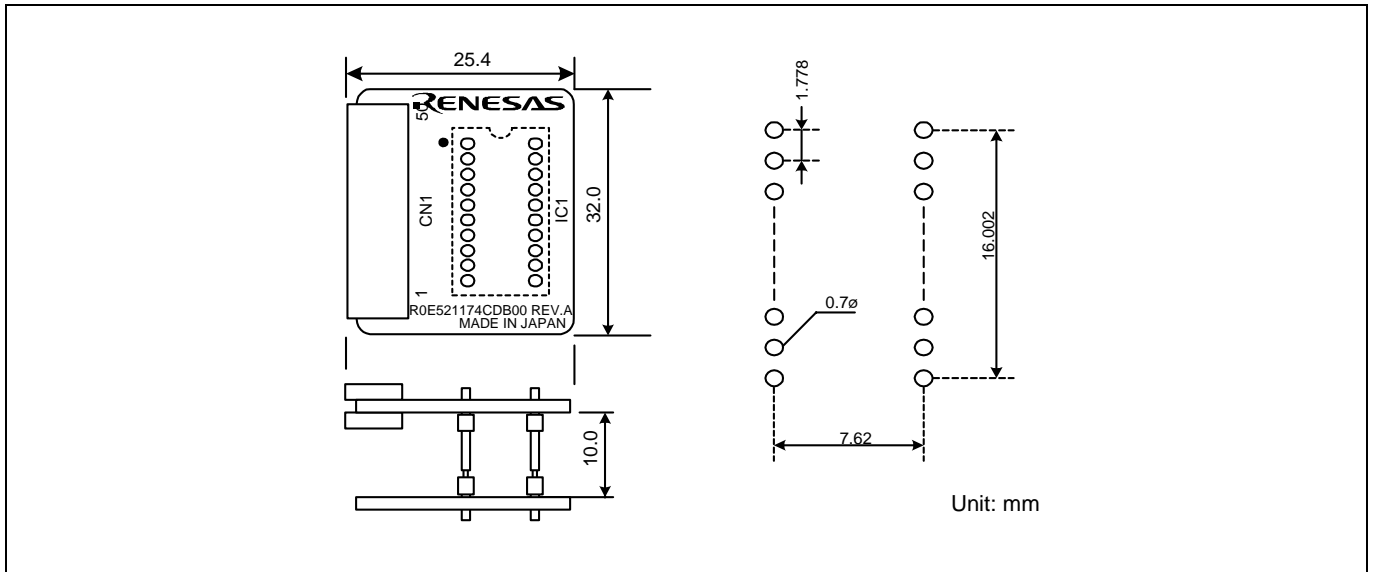

Figure 4.6 External dimensions and a sample foot pattern of the R0E521174CDB00

4.4.5 External Dimensions of the Converter Board R0E521237CFK00

Figure 4.7 shows external dimensions and a sample foot pattern of the converter board R0E521237CFK00 (included with the R0E521237EPB00) for a 48-pin 0.5mm pitch LQFP.

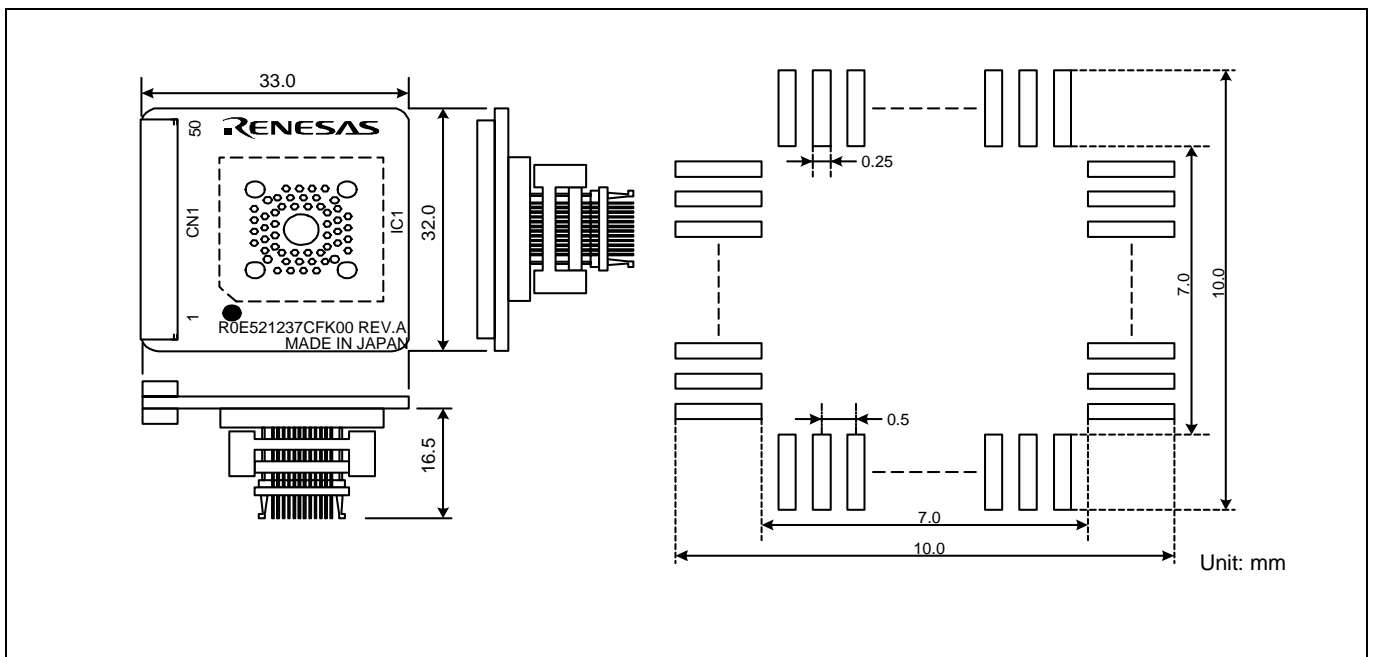

Figure 4.7 External dimensions and a sample foot pattern of the R0E521237CFK00

4.4.6 External Dimensions of the Converter Board R0E521258CFJ00

Figure 4.8 shows external dimensions and a sample foot pattern of the converter board R0E521258CFJ00 (included with the R0E521258EPB00) for a 52-pin 0.65mm pitch LQFP.

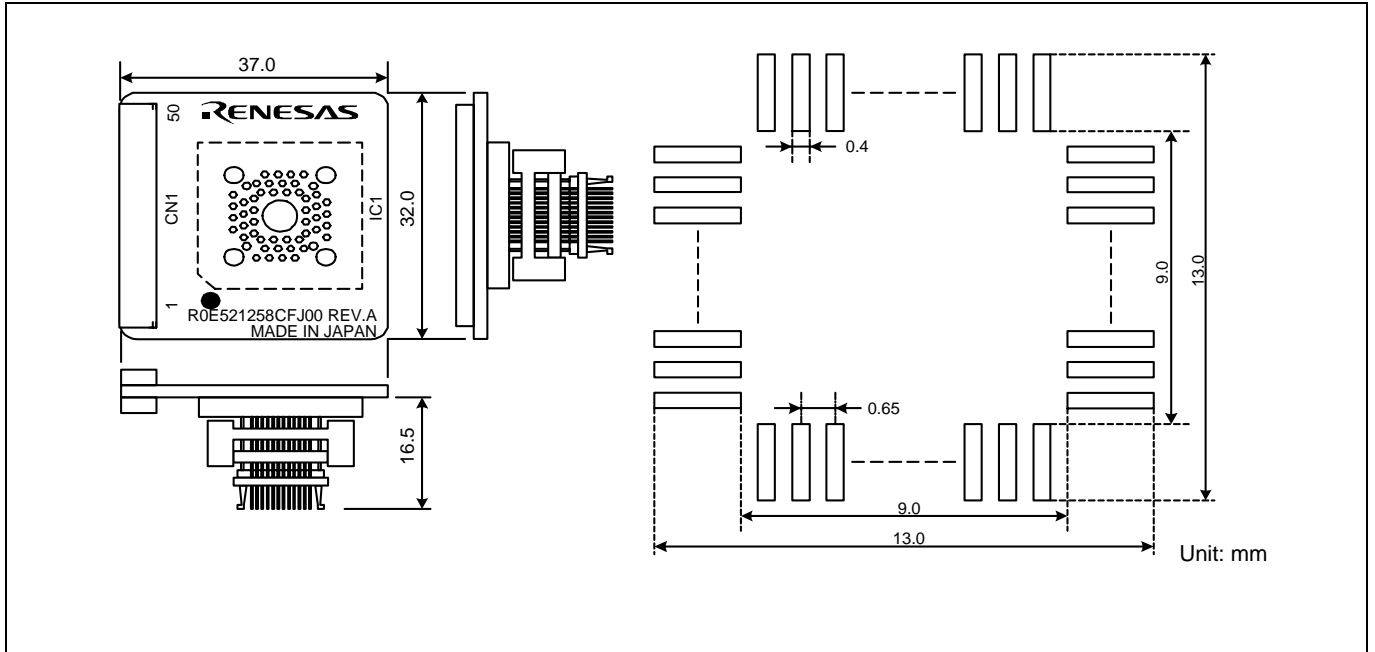

Figure 4.8 External dimensions and a sample foot pattern of the R0E521258CFJ00

4.4.7 External Dimensions of the Converter Board R0E521276CFG00

Figure 4.9 shows external dimensions and a sample foot pattern of the converter board R0E521276CFG00 (included with the R0E521276EPB00) for a 32-pin 0.8mm pitch LQFP.

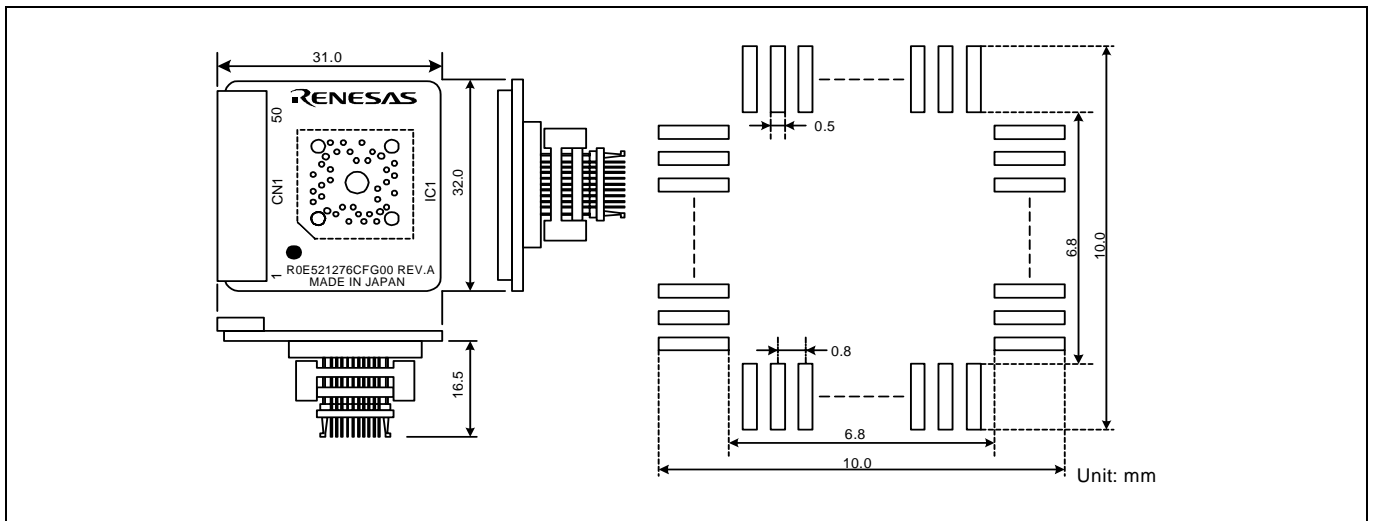

Figure 4.9 External dimensions and a sample foot pattern of the R0E521276CFG00

4.4.8 External Dimensions of the Converter Board R0E5212BACFG00

Figure 4.10 shows external dimensions and a sample foot pattern of the converter board R0E5212BACFG00 (included with the R0E5212BAEPB00) for a 64-pin 0.8mm pitch LQFP.

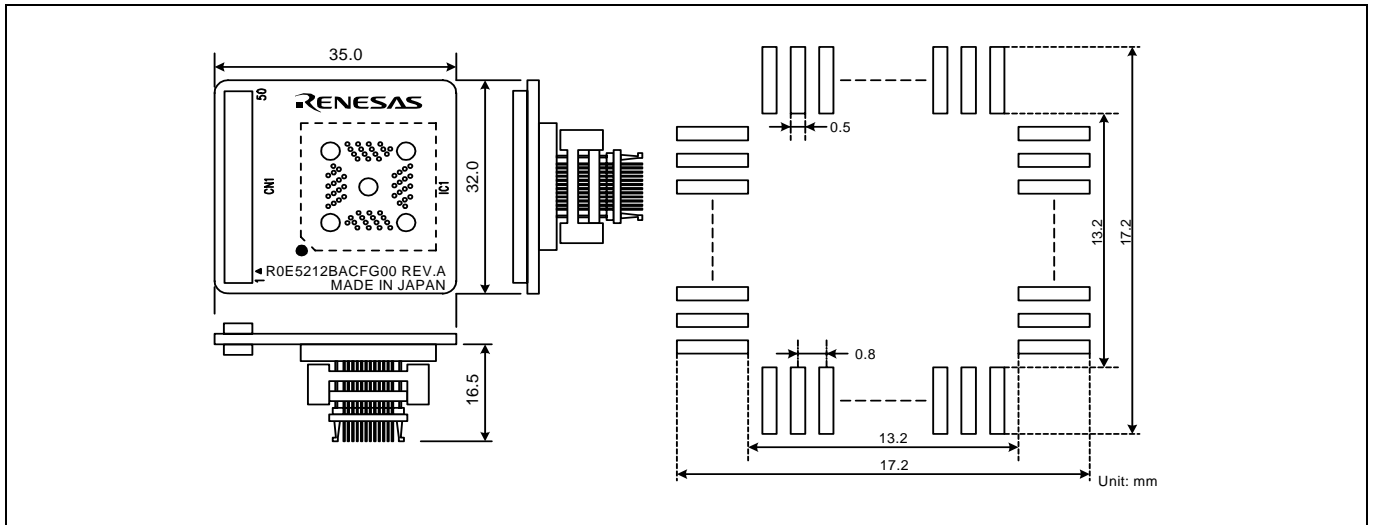

Figure 4.10 External dimensions and a sample foot pattern of the R0E5212BACFG00

4.4.9 External Dimensions of the Converter Board R0E5212BACFK00

Figure 4.11 shows external dimensions and a sample foot pattern of the converter board R0E5212BACFK00 (included with the R0E5212BAEPB10) for a 64-pin 0.5mm pitch LQFP.

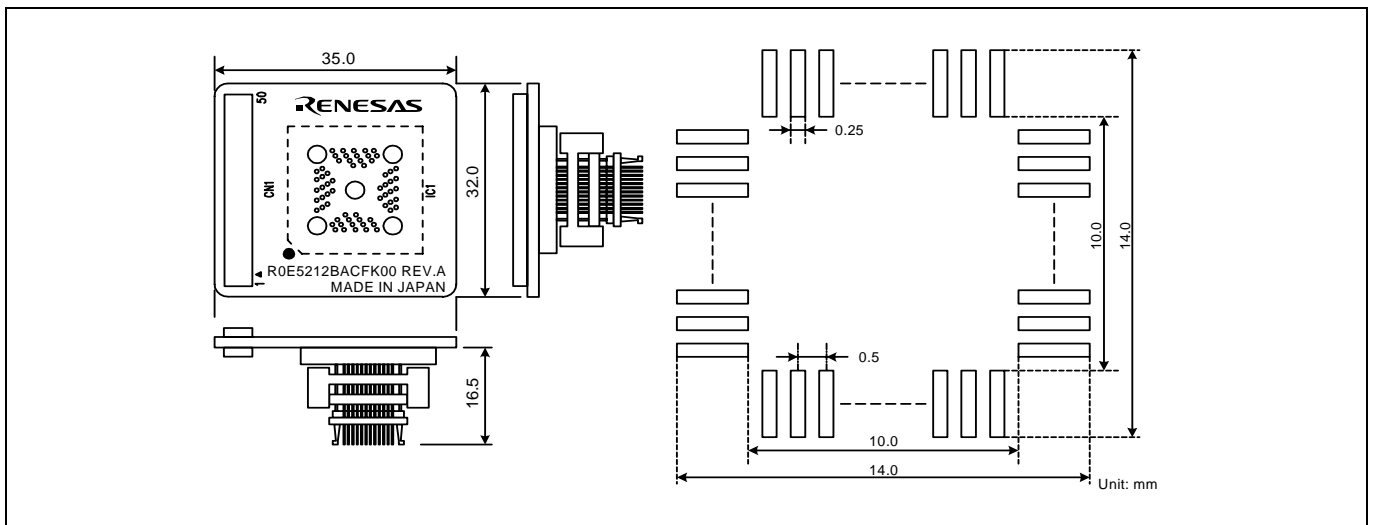

Figure 4.11 External dimensions and a sample foot pattern of the R0E5212BACFK00

4.4.10 External Dimensions of the Converter Board R0E5212DACFK00

Figure 4.12 shows external dimensions and a sample foot pattern of the converter board R0E5212DACFK00 (included with the R0E5212DAEPB00) for an 80-pin 0.5mm pitch LQFP.

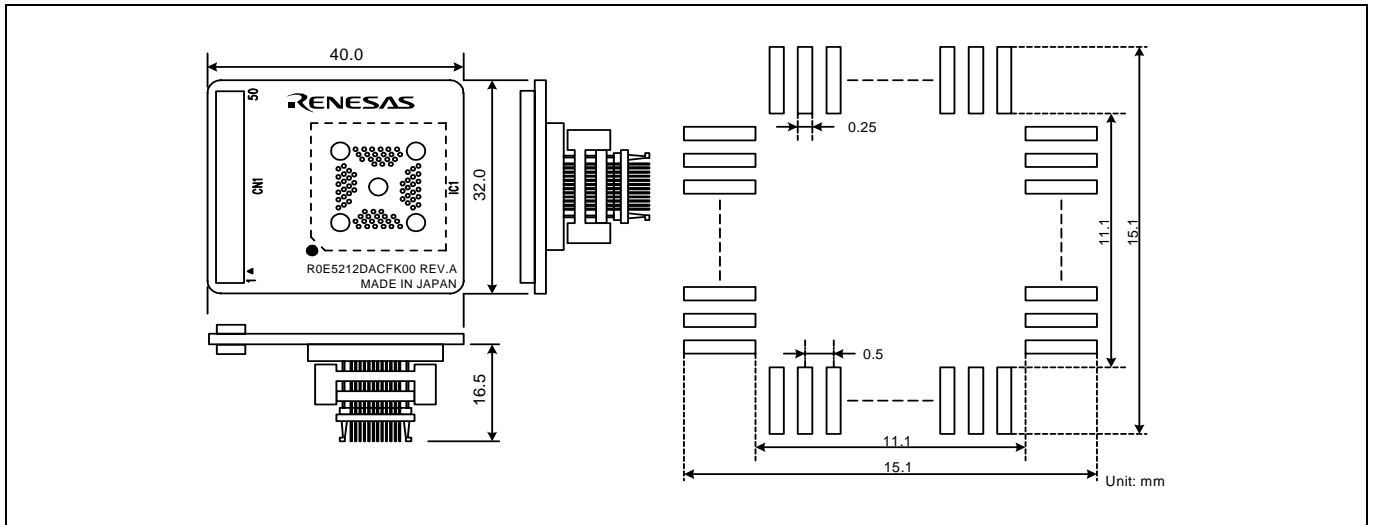

Figure 4.12 External dimensions and a sample foot pattern of the R0E5212DACFK00

4.4.11 External Dimensions of the Converter Board R0E5212L4CFG00

Figure 4.13 shows external dimensions and a sample foot pattern of the converter board R0E5212L4CFG00 (included with the R0E5212L4EPB00) for a 32-pin 0.8mm pitch LQFP.

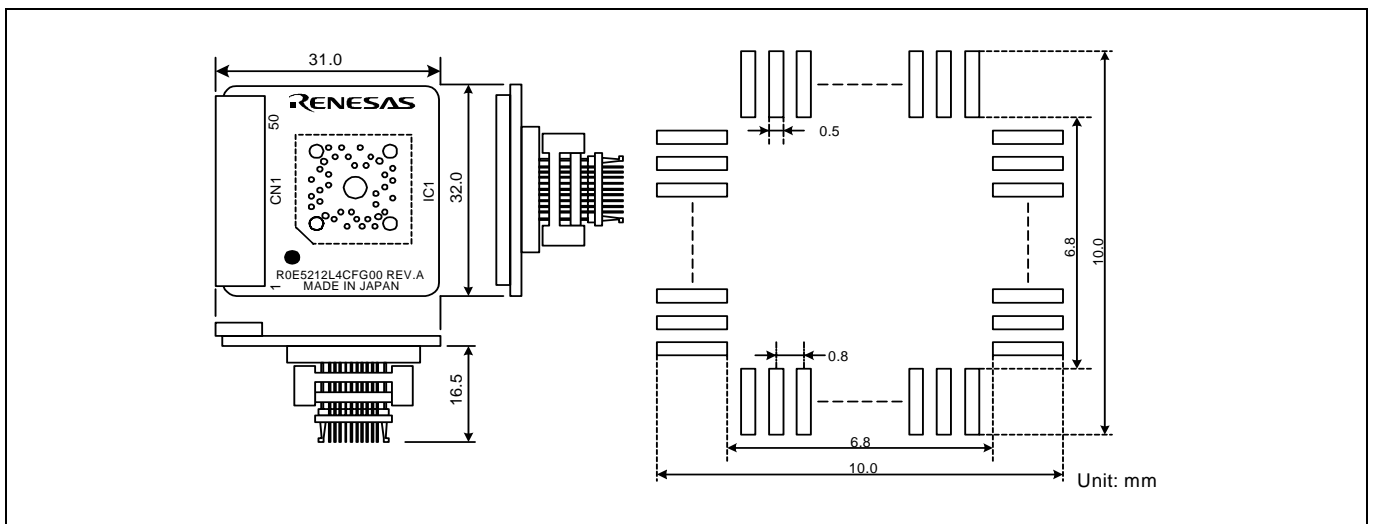

Figure 4.13 External dimensions and a sample foot pattern of the R0E5212L4CFG00

4.5 Notes on Using This Product

Notes on using this product are listed below. When debugging the MCU using this product, be careful about the following precautions.

IMPORTANT

Notes on Downloading Firmware:

- Before using this product for the first time, it is necessary to download the dedicated firmware (control software built into the PC7501). Please note that, to do this, it is necessary to start up the PC7501 in maintenance mode. For firmware download procedures, see "2.7 Downloading Firmware" (page 26). Once the firmware has been downloaded, the product can be used by simply turning on the power.
- Do not shut off the power while downloading the firmware. If this happens, the product will not start up properly. If power is shut off unexpectedly, redownload the firmware.

Notes on the Self-check:

- If the self-check does not result normally (excluding user system errors), the emulation probe may be damaged. Then contact your local distributor.
- Be sure to disconnect the user system before executing the self-check.

Note on Quitting the Emulator Debugger:

- To restart the emulator debugger after it ends, always shut power to the PC7501 module off once and then on again.

Notes on the User System (Power Supply, Order of Powering On):

- The emulator's pin VCC is connected to the user system in order to monitor user system voltage. For this reason, the emulator cannot supply power to the user system. Therefore, provide the user system with a separate power supply from that of the emulator.
- Settings of the POWER selection jumper need to be changed according to the power supply voltage and power supply condition of the user system.
 - (1) The voltage of the user system should be 2.7V to 5.5V when the POWER selection jumper is set to the INT POWER side. Turn ON/OFF the user system and the emulator as simultaneously as possible.
 - (2) The voltage of the user system is less than 2.7V, set the POWER selection jumper to the EXT POWER side. When the POWER selection jumper is set to the EXT POWER side, this product consumes max. 500 mA of electrical current from the user system. For details about the POWER selection jumper, refer to "2.10.2 Setting the POWER Selection Jumper" (page 39).
- Before powering on your emulator system, check that the host machine, the emulator, the converter board and user system are all connected correctly.
- When the emulator debugger starts up, check the target status LEDs on the emulator to see if this product is ready to operate.

IMPORTANT

Notes on Clock Supply to an MCU:

- A clock supplied to the evaluation MCU is selected by the Emulator tab in the Init dialog box of the emulator debugger.
 - (1) When "Internal" is selected (main and sub clocks):
The clock generated by the oscillation circuit in the PC7501 is supplied to the evaluation MCU. The clock is continually supplied to the evaluation MCU regardless of a state of user system clock and a state of user program execution.
 - (2) When "External" is selected (main and sub clocks):
The clock oscillating on the user system is supplied to the evaluation MCU. Clock supply to the evaluation MCU depends on an oscillation state (oscillate/off) of the user system.
 - (3) When "Generate" is selected (main clock):
A clock generated by the dedicated circuit in the PC7501 is supplied to the evaluation MCU. The clock is continually supplied to the evaluation MCU regardless of a state of user system clock and a state of user program execution.

Note on Stop and Wait Mode:

- Do not single-step an instruction shifting to stop or wait mode. It may cause communications errors.

Notes on Software Break:

- A software break generates a break interruption by forcibly inserting a BRK instruction "00h" instead of an instruction code. Therefore, when referencing the result of a trace in bus mode, "00h" is displayed for the instruction fetch address where a software break is set.
- As the BRK instruction is used for the emulator, do not use it in a user program.

Note on the Watchdog Timer:

- If the reset circuit of the user system has a watchdog timer, disable it when using the emulator.

Notes on Address-Match Interrupt:

- Do not set a software break at the address for which an address-match interrupt will be generated, because it will cause the user program to run out of control. Make sure software and hardware breaks are set at the beginning of the address-match interrupt processing.
- If the address for which an address-match interrupt will be generated is single-stepped, the user program is halted when the address-match interrupt processing is executed and the first instruction after return from the interrupt is executed.

Note on Protect Resistor:

- The protect is not canceled when bit 2 of protect register PRCR (PRC2), which enables writing into the port P0 direction register, is changed with the below procedure.
 - (1) Single step execution of an instruction setting PRC2 to "1"
 - (2) Execution from the instruction setting "1" to PRC2 where a software breakpoint is set
 - (3) Setting a break point between an instruction setting PRC2 to "1" and a point where the port P0 direction register is set
 - (4) Setting PRC2 to "1" by the memory window or script window

Note on Debugging Operations after Releasing a Reset from the User System:

- Do not execute debugging operations (such as stopping the user program execution by a software or hardware break, run-time debugging) after releasing a reset on the user system until an interrupt stack pointer (ISP) is set in the user program.

IMPORTANT

Note on Debugging in CPU Rewrite Mode:

- When you debug the MCUs in CPU rewrite mode, check "Debug the program using CPU Rewrite Mode" in the MCU tab of the Init dialog box of the emulator debugger.

Notes on Restrictions on Debugging in CPU Rewrite Mode:

- If you check "Debug the program using CPU Rewrite Mode" in the MCU tab of the Init dialog box of the emulator debugger, you cannot use the following functions.
 - (1) Setting or releasing software breakpoints in an internal ROM area while executing the user program
 - (2) Program or data rewrite operation to an internal ROM area
 - (3) Setting or releasing hardware breakpoints while executing the user program
- If the user program is halted by the Stop button or a break when erasing or programming the flash ROM, the erase or program operation is stopped. Once this occurs, the user program may not operate as expected when it is reexecuted from where it stopped. If the user program is stopped accidentally, redownload and reexecute the program. If when the user program is halted no block erase or program operation is in progress, the user program can be executed normally from where it stopped.

Note on Data Display during Debugging in CPU Rewrite Mode:

- In the read status register mode of CPU rewrite mode, the read values displayed in the memory window, etc. when the user program is running show the status register values. Note that when the user program is idle, the read values show data values.

Running/idle	Mode	Window display
User program running	Read status register mode of CPU rewrite mode	Status register values are displayed.
	Other	Data values are displayed.
User program idle	Read status register mode of CPU rewrite mode	Data values are displayed.
	Other	Data values are displayed.

Be aware, however, that the values displayed in the memory window or the RAM monitor window are retained intact unless you press the Refresh or the Clear button.

Note on Data Write to the Internal ROM Area in CPU Rewrite Mode:

- When writing data to the internal ROM area in CPU rewrite mode, this product permits the data bits to be set to either 1 or 0. This is different from the actual MCU, because in the actual MCU you only can set the data bits to 0.

Note on Trace Data Display When Rewriting the Flash ROM in EW1 Mode:

- For data display in the trace window when using EW1 mode, be sure to select source mode or bus mode. If disassemble mode or data access mode is selected, the debugger will take time for analysis of the trace data to be displayed.

5. Troubleshooting

This chapter describes how to troubleshoot when this product does not work properly.

5.1 Flowchart to Remedy the Troubles

Figure 5.1 shows the flowchart to remedy the troubles from when the emulator is activated until the emulator debugger starts up. At first, check this when the user system is disconnected. After confirming that there are no problems, then check this when the user system is connected. For the latest FAQs visit the Renesas Tools Homepage.

<http://www.renesas.com/tools>

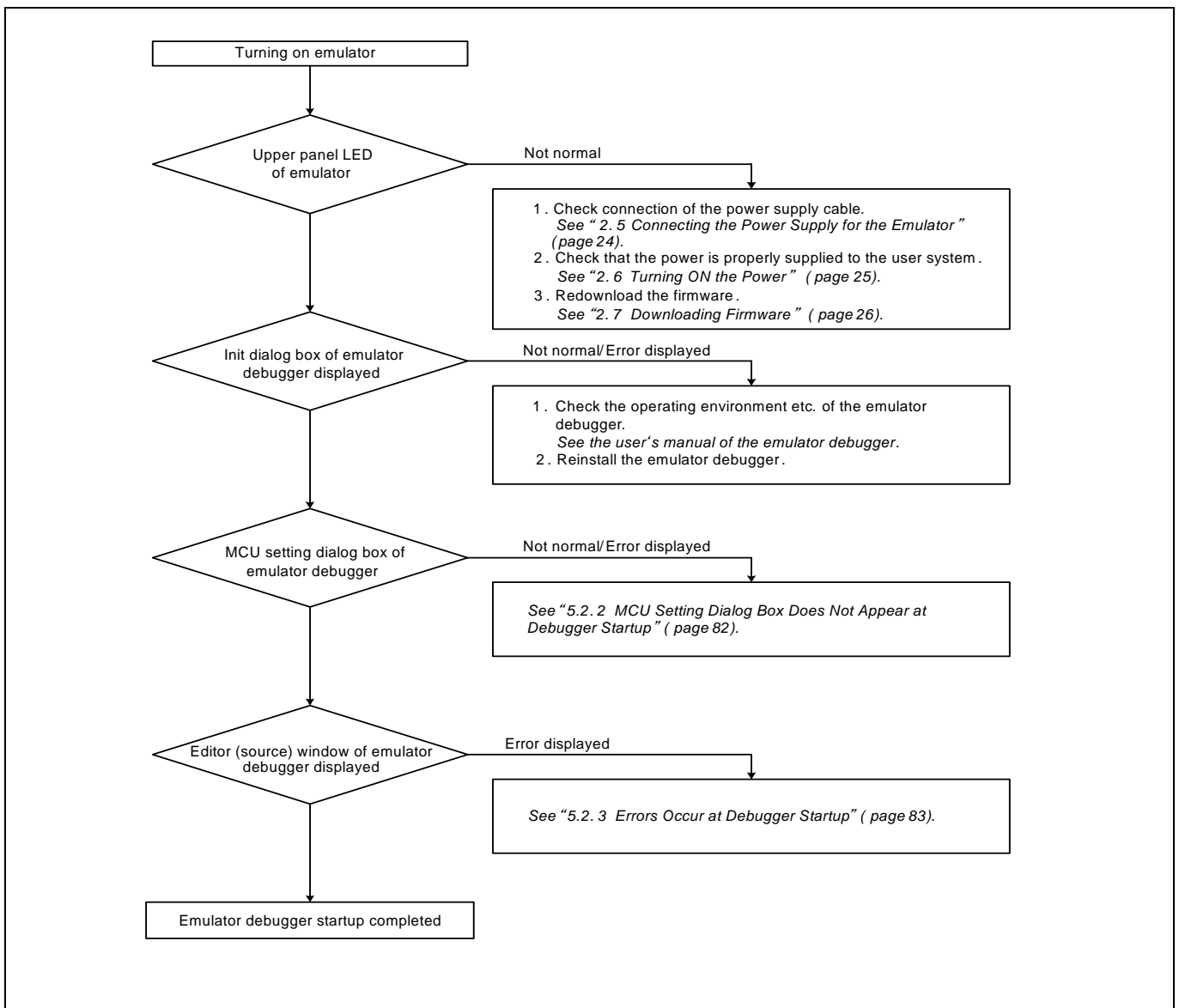

Figure 5.1 Flowchart to remedy the troubles

5.2 When the Emulator Debugger Does Not Start Up Properly

5.2.1 When the LEDs of the PC7501 Do Not Display Normally

Table 5.1 Errors LEDs show and their checkpoints

Error	Connection to the user system	Checkpoint
LEDs do not light up.	-	Check that the power cable is connected. <i>See "2.5 Connecting the Power Supply for the Emulator" (page 24).</i>
All LEDs remain lit.	-	Recheck the connection between the PC7501 and this product. <i>See "2.4 Connecting the PC7501" (page 23).</i>
The POWER LED of "TARGET STATUS" does not light up.	Connected	Check that power (VCC) is properly supplied to the user system and that the user system is properly grounded.
The CLOCK LED of "TARGET STATUS" does not light up.	Not connected	(1) Check that both the main and sub clocks of the emulator debugger are not set to "EXT". <i>See the CLK command of the emulator debugger.</i> (2) Check the oscillation circuit in the emulator is oscillating. <i>See "2.10.3 Selecting Clock Supply" (page 40).</i>
	Connected	(1) When the clock is supplied from an external oscillator, check that the oscillator circuit in the user system is oscillating properly. (2) Check the switches in the emulation probe are properly set. <i>See "2.10.1 Setting Switches of Emulation Probe" (page 38).</i>
The RESET LED of "TARGET STATUS" does not go out.	Connected	Check that the reset pin of the user system is held high.

5.2.2 MCU Setting Dialog Box Does Not Appear at Debugger Startup

Table 5.2 Checkpoints of errors at debugger startup

Error	Connection to the user system	Checkpoint
Communication error occurred. Data was not sent to the target.	-	Check all emulator debugger settings, interface cable settings and switches on the rear of the PC7501 match. <i>See the user's manuals of PC7501 and emulator debugger (online manual).</i>
User system cannot be properly built.	-	(1) Download the proper firmware. <i>See "2.7 Downloading Firmware" (page 26).</i> (2) Recheck the connection between the PC7501 and this product. <i>See "2.4 Connecting the PC7501" (page 23).</i>
The emulator debugger's version is not the same version as the firmware in the target.	-	Download the proper firmware. <i>See "2.7 Downloading Firmware" (page 26).</i>
Target MCU is in the reset state.	Connected	Check the reset pin of the user system is held high.
Target MCU cannot be reset.	Connected	(1) If the reset circuit of the user system has a watchdog timer, disable the timer. (2) Check that power is properly supplied to the user system and that the user system is properly grounded.
Target is in "HOLD" state.	-	The MCU is either in stop mode or wait mode. Either reset the MCU or cancel the mode with an interrupt. <i>See MCU specifications.</i>
Target clock is stopped.	Connected	When the clock is supplied from an external oscillator, check that the oscillator circuit in the user system is oscillating properly.
Target MCU is not receiving power.	Connected	Check that power is properly supplied to the user system and that the user system is properly grounded.

5.2.3 Errors Occur at Debugger Startup

Table 5.3 Checkpoints of errors at debugger startup

Error	Connection to the user system	Checkpoint
Target MCU is uncontrollable.	Connected	(1) Check that the NQPACK etc. mounted on the user system is soldered properly. (2) Check that the connector is installed properly to the user system.

5.3 How to Request a Support

After checking the items in "5 Troubleshooting", fill in the text file which is downloaded from the following URL, then send the information to your local distributor.

<http://tool-support.renesas.com/eng/toolnews/registration/support.txt>

For prompt response, please specify the following information:

(1) Operating environment

- Operating voltage: _____ [V]
- Operating frequency: _____ [MHz]
- Clock supply to the MCU: Internal oscillator/External oscillator

(2) Condition

- The emulator debugger starts up/does not start up
- The error is detected/not detected in the self-check
- Frequency of errors: always/frequency (_____)

(3) Problem

6. Maintenance and Guarantee

This chapter describes how to perform maintenance, warranty information, repair provisions and the procedures for requesting a repair.

6.1 User Registration

When you purchase our product, be sure register as a user. For user registration, refer to "User registration" (page 11) of this user's manual.

6.2 Maintenance

- (1) If dust or dirt collects on any equipment of your emulation system, wipe it off with a dry soft cloth. Do not use thinner or other solvents because these chemicals can cause the equipment's surface coating to separate.
- (2) When you do not use this product for a long period, for safety purposes, disconnect the power cable from the power supply.

6.3 Guarantee

If your product becomes faulty within one year after its purchase while being used under good conditions by observing "IMPORTANT" and "Precautions for Safety" described in this user's manual, we will repair or replace your faulty product free of charge. Note, however, that if your product's fault is raised by any one of the following causes, we will repair it or replace it with new one with extra-charge:

- Misuse, abuse, or use under extraordinary conditions
- Unauthorized repair, remodeling, maintenance, and so on
- Inadequate user's system or misuse of it
- Fires, earthquakes, and other unexpected disasters

In the above cases, contact your local distributor. If your product is being leased, consult the leasing company or the owner.

6.4 Repair Provisions

(1) Repairs not covered by warranty

The products elapsed more than one year after purchase is not covered by warranty.

(2) Replacement not covered by warranty

If your product's fault falls in any of the following categories, the fault will be corrected by replacing the entire product instead of repair, or you will be advised to purchase new one, depending on the severity of the fault.

- Faulty or broken mechanical portions
- Flaw, separation, or rust in coated or plated portions
- Flaw or cracks in plastic portions
- Faults or breakage caused by improper use or unauthorized repair or modification
- Heavily damaged electric circuits due to overvoltage, overcurrent or shorting of power supply
- Cracks in the printed circuit board or burnt-down patterns
- Wide range of faults that makes replacement less expensive than repair
- Unlocatable or unidentified faults

(3) Expiration of the repair period

When a period of one year elapses after the model was dropped from production, repairing products of the model may become impossible.

(4) Transportation fees at sending your product for repair

Please send your product to us for repair at your expense.

6.5 How to Make Request for Repair

If your product is found faulty, fill in the Repair Request Sheet included with this product, then send it along with this product for repair to your local distributor. Make sure that information in the Repair Request Sheet is written in as much detail as possible to facilitate repair.

CAUTION

Note on Transporting the Product:



- When sending your product for repair, use the packing box and cushion material supplied with this product when delivered to you and specify handling caution for it to be handled as precision equipment. If packing of your product is not complete, it may be damaged during transportation. When you pack your product in a bag, make sure to use conductive polyvinyl supplied with this product (usually a blue bag). When you use other bags, they may cause a trouble on your product because of static electricity.

< MEMO >

Emulation Probe for R8C/Tiny Series
R0E521000EPB00 User's Manual

Publication Date: Oct. 16, 2007 Rev.4.00

Published by: Sales Strategic Planning Div.
 Renesas Technology Corp.

Edited by: Microcomputer Tool Development Department
 Renesas Solutions Corp.

R0E521000EPB00
User's Manual



Renesas Electronics Corporation

1753, Shimonumabe, Nakahara-ku, Kawasaki-shi, Kanagawa 211-8668 Japan

REJ10J0844-0400(T)