

FMG/FML

Rating/ Characteristics	Absolute Maximum Ratings						Electrical Characteristics (Ta = 25°C)					Others											
	V _{RSM} (V)	V _{RM} (V)	I _o (A)	I _{FSM} (A)	T _j (°C)	T _{stg} (°C)	V _F (V)	I _R (mA)	I _{R(H)} (mA)	trr (μs)	Outline Drawing	Weight(g)	Taping	Note									
Type No.	per chip		With Fin	50Hz Sine Half Wave Single Pulse 10ms.			Max, per chip	I _F (A)	V _R = V _{RM} max (per chip)	V _R = V _{RM} , T _j = 150°C max (per chip)	I _F /I _{RP} (mA)												
FMG-11S, R	100	100	5.0	35	-40 ~ +150		1.3	2.5	0.5	0.1	100/100	2.1											
FMG-12S, R	200	200																					
FMG-13S, R	300	300																					
FMG-14S, R	400	400																					
FMG-21S, R	100	100	10	65			1.3	5.0	2.5			0.5			0.1	100/100	2.1						
FMG-22S, R	200	200																					
FMG-23S, R	300	300																					
FMG-24S, R	400	400																					
FMG-26S, R	600	600	8.0	50			2.2	3.0	3.0			500/500			5.5								
FMG-31S, R	100	100	20	150			1.3	10	1.0			5.0			0.1	100/100	2.1						
FMG-32S, R	200	200																					
FMG-33S, R	300	300																					
FMG-34S, R	400	400																					
FMG-36S, R	600	600	16	100			2.0	7.5	5.0			500/500			5.5								
FMG-G26S	600	600	4.0	50			2.5	4.0	0.5			3.0			500/500	5.5							
FMG-G36S	600	600	8.0	80			2.5	8.0	0.5			3.0			500/500	5.5							
FML-11S	100	100	5.0	35	-40 ~ +150		0.98	2.5	0.15	0.1	100/100	2.1											
FML-12S	200	200																					
FML-13S	300	300																					
FML-14S	400	400																					
FML-21S	100	100	10	65			0.98	5.0	0.25			1.0			0.04	100/100	2.1						
FML-22S	200	200																					
FML-23S	300	300																					
FML-24S	400	400																					
FML-31S	100	100	20	150			0.98	10	0.6			2.0			0.04	500/500	5.5						
FML-32S	200	200																					
FML-33S	300	300																					
FML-34S	400	400																					
FML-G12S	200	200	5.0	65			0.98	5.0	0.25			1.0			0.04	100/100	2.1						
FML-G13S	300	300																					
FML-G14S	400	400																					
FML-G16S	600	600																					
FML-G22S	200	200	10	150	0.98	10	0.5	2.0	0.04	100/100	2.1												

For High Frequency Rectification

Thermal Resistance R_{th(j-c)} max : 4.2°C/W (FMG-G26S)
2.1°C/W (FMG-G36S)

Outline Drawing ⑥②

Outline Drawing ⑥③

Outline Drawing ⑥④

Outline Drawing ⑥⑤

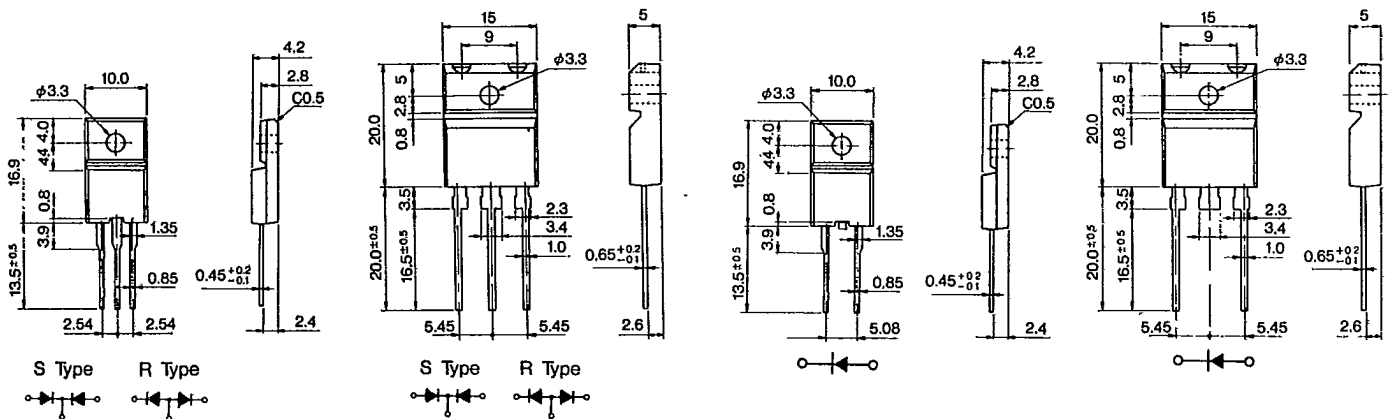

⑥② ~ ⑥⑤ Plastic Molding, Flammability : UL94V-0 or Equivalent

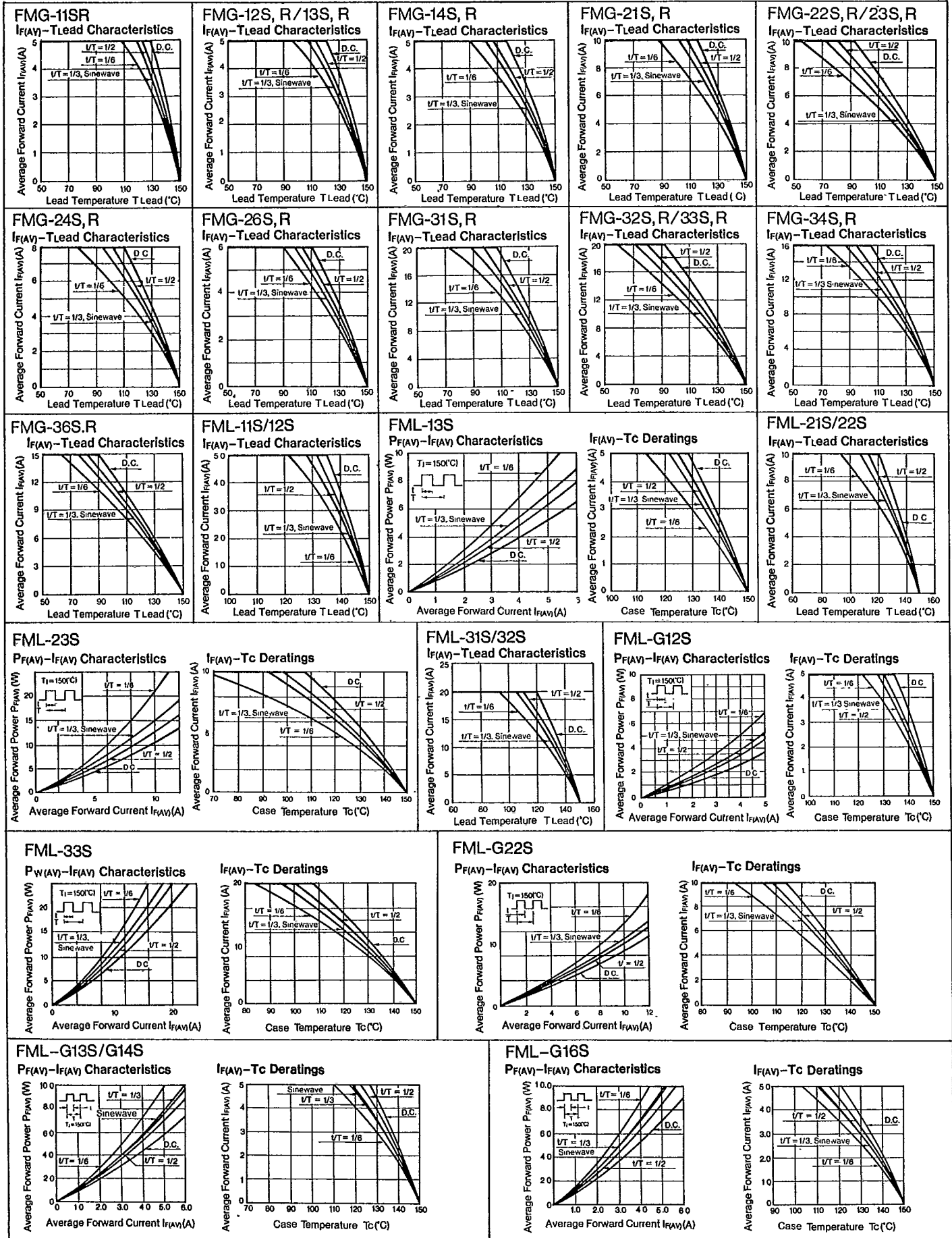

Symbols/trr Measurement Circuit

Symbols

V_{RSM}	Peak Reverse Surge Voltage	I_{RSM}	Peak Reverse Surge Current	T_{stg}	Storage Temperature
V_{RM}	Peak Reverse Voltage	I_R	Reverse Current	t_{rr}	Reverse Recovery Time
V_{P-P}	Reverse Voltage (Peak to Peak)	I_{RP}	Peak Reverse Current	C_t	Total Capacitance Between Terminals
V_R	Reverse Voltage	$I_{R(H)}$	Reverse Current (High Temperature)	$R_{th(j-c)}$	Thermal Resistance, Junction to Case
V_F	Forward Voltage	I_Z	Avalanche Current	r_z	Temperature Coefficient of Breakdown Voltage
V_B	Breakdown Voltage	I_{ZSM}	Allowable Avalanche Current	R_z	Equivalent Resistance of Breakdown Region
I_o	Average Rectified Forward Current	T_a	Ambient Temperature	$P_{F(AV)}$	Average Forward Power Dissipation
I_F	Forward Current	T_j	Junction Temperature	I_t	I_t limiting Value
$I_{F(AV)}$	Average Forward Current	T_{opr}	Operating Ambient Temperature		
I_{FSM}	Peak Forward Surge Current	T_c	Case Temperature		

Reverse Recovery Time Measurement Circuit

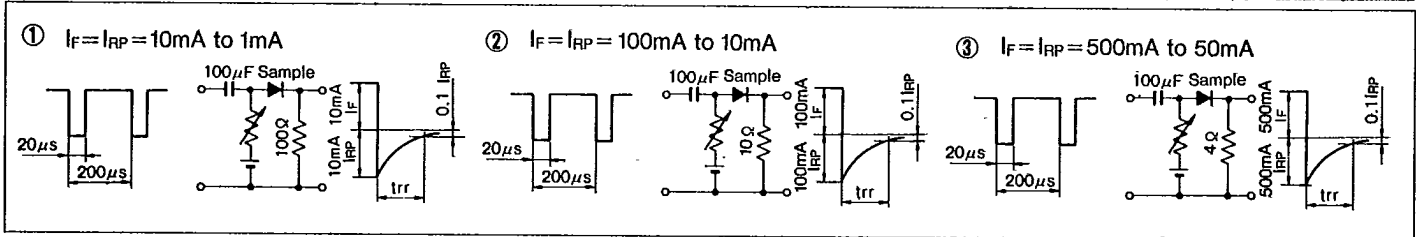

Taping Specifications

Excluding High Voltage Diodes

Designation	Dimension (in mm)	Packaging Dimension and Marking	Quantity
V Add Suffix [V] to Type No.	<p>Tape Carrier Method</p> <p>(1) Right side of taping direction is cathode. (2) Place electrode side down when casing. (3) Provide leader tape of 150~200mm at beginning of tape. (4) Provide space of more than 10 pitches each for beginning and end of tape.</p>	<p>Reel</p> <p>Marking of Type No., Lot No. and Quantity</p>	1,800 pcs per reel
V Add Suffix [V] to type No.	<p>Axial Taping</p>	<p>Reel</p> <p>Markings of Type No. Lot No. and Quantity</p>	5,000 pcs per reel (2.7 φ body) 3,000 pcs per reel (4.0 φ body)

Taping Specifications

Designation	Dimension (in mm)	Packaging Dimension and Marking	Quantity
<p>V1</p> <p>Add Suffix [V1] to Type No.</p>	<p>Axial Taping</p>	<p>Ammunition Pack</p>	<p>2,000 pcs per box (2.7 φ body)</p> <p>1,000 pcs per box (4.0 φ body)</p>
<p>VO</p> <p>Add Suffix [VO] to Type No.</p>	<p>Axial Taping</p>	<p>Ammunition Pack</p>	<p>2,000 pcs per box (2.7 φ body)</p> <p>(2.4 φ body)</p>
<p>V3</p> <p>Add Suffix [V3] to Type No.</p>	<p>Axial Taping</p>	<p>Reel</p>	<p>1,500 pcs per reel (5.2 φ body)</p>
<p>V4</p> <p>Add Suffix [V4] to Type No.</p>	<p>Axial Taping</p>	<p>Ammunition Pack</p>	<p>1,000 pcs per box (5.2 φ body)</p>
<p>W</p> <p>Add Suffix [W] to Type No.</p>	<p>Radial Taping</p>	<p>Ammunition Pack</p>	<p>4,000 pcs per box (2.7 φ body)</p> <p>(0.6 φ lead)</p>
<p>WS</p> <p>Add Suffix [WS] to Type No.</p>	<p>Radial Taping (Applicable to AO Series)</p>	<p>Ammunition Pack</p>	<p>2,500 pcs per box (2.4 φ body)</p>
<p>WK</p> <p>Add Suffix [WK] to Type No.</p>	<p>Radial Taping (Applicable to AO Series)</p>	<p>Ammunition Pack</p>	<p>2,500 pcs per box (2.4 φ body)</p>

Marking Guide

1 Small TMD

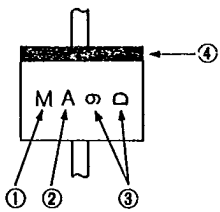

- ① Type Designation (in abbreviation)
AM01 is abbreviated as M.
- ② Class Designation
Z: 200V, No Letter: 400V, A: 600V
- ③ A: Year (Last Number of AD Year)
B: Month (Jan. to Sept. are represented by numbers 1 to 9 respectively, and Oct., Nov., and Dec. are abbreviated as O, N and D respectively)
- ④ Cathode Band: Successive Band, however AU02 Type is Non-Successive Band.

2 E/EO Type TMD

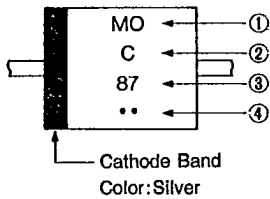

- ① Type Designation (in abbreviation)
EM01 is abbreviated as MO, EM2 is abbreviated as M2.
- ② Class Designation
Z: 200V, No Letter: 400V, A: 600V
B: 800 V, C: 1000V, F: 1500V
However, EU02A to be marked 2A, and EU2YX to be marked Y.
- ③ Abbreviations Representing Production Period
A: Year (Last Number of AD Year)
B: Month (1~9, O, N, D)
- ④ Production Period Divided in 3 ten day terms
.: 1st 10days .. : 2nd 10days ... : 3rd 10days

3 R Type TMD

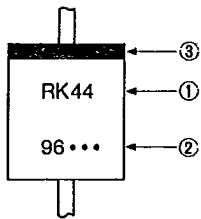

- ① Type Designation: Mark in 2 sets
- ② Production Period: Mark in 4 sets
A: Year (Last Number of AD Year)
B: Month (1~9, O, N, D)
- ③ Production Period Divided in 3 ten day terms
.: 1st 10days .. : 2nd 10days ... : 3rd 10days
- ④ Cathode Band Color: Silver: For Power Supply
Yellow: For Middle Speed
Red : For High Speed and Ultra-High Speed

4 RB40/60

(RB40 Series)

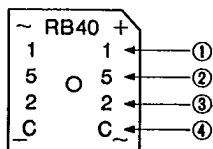

- ① Peak Reverse Voltage Designation
1, 2, 4, 6, C
Production Period
- ② Year (Last Number of AD Year)
- ③ Month (1~9, O, N, D)
- ④ Divided in 3 ten day terms
A: 1st 10days, B: 2nd 10days
C: 3rd 10days
Color Designation: Silver

(RB60 Series)

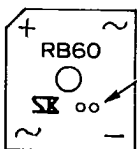

Dot Designation RB601 Violet
RB602 No Color
RB604 Blue
RB606 White

5 RBV/RBA

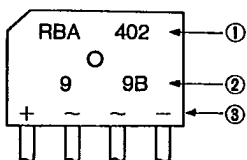

- ① Type Designation
- ② Lot Number
1st : Year (Last Number of AD Year)
2nd: Month (1~9, O, N, D)
3rd : Divided 1~3 ten day Terms
A: 1st 10 days B: 2nd 10 days
C: 3rd 10 days
- ③ In-Put Designation

6 T0220 Type (FM or CT Type)

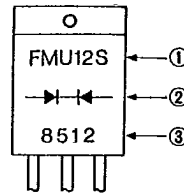

- ① Type Designation
Show FMU-12S as FMU12S.
- ② Polarity: Rectifier Symbols
- ③ Lot Number (Laser Marking)
1st : Year (Last Number of AD Year)
2nd : Month (0~9, O, N, D)
3rd, 4th: Day

7 T0220 Type (FM or CT Type, single chip)

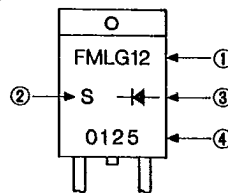

- ① Type Designation: Omit Last Letter
Show FML-G12S as FMLG12.
- ② Last Letter of Type Designation
- ③ Polarity: Rectifier Symbols
- ④ Lot Number (Laser Marking)
1st : Year (Last Number of AD Year)
2nd : Month (0~9, O, N, D)
3rd, 4th: Day

8 T03P Type (FM or CT Type)

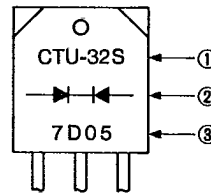

- ① Type shown in full designation
However, CTB-34/34S/34M are marked as CTB-34, CTU-G3DR is marked as CTUG3DR.
- ② Polarity: Rectifier Symbols
- ③ Lot Number:
1) M, U, G and L Types
First Number : Last Digit of AD Year
Second Number : Month
Third and Fourth Numbers: Day
Fifth Number : None
2) For types CTB-34/34S/34M, the fifth letter shows type designation. If no fifth number, the type is CTB-33 or CTB-34.
3) Marking Color: Silver

9 MI-10/15 Type

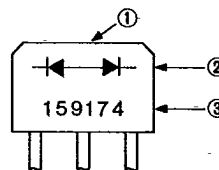

- ① MI-10/15 is die-stamped on the top of the case.
- ② Rectifier Symbols
- ③ Lot Number:
First Number : Peak Reverse Voltage:
(Letter) 0=50V, 1=100V, 2=200V,
4=400V, 6=600V, C=1000V
Second Number : Last Digit of AD Year
Third Number : Month
Fourth and Fifth Numbers: Day
Sixth Number : Production number and
U: Voltage Doubler Type

10 SFP Type

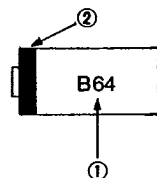

- ① Type Designation:
SFPB-64 is abbreviated at B64.
- ② Cathode Band