

IEC Appliance Inlet C14 with Filter, Fuseholder 1- or 2-pole (5x20 mm or 6.3x32 mm), optional Voltage Selector (step switch)

Standard- or Medical-Filter



V-Lock



with voltage selector



without voltage selector



Description

- Panel Mount:
Screw-on mounting from front side
- 4 Functions:
Appliance Inlet Protection class I, Fuseholder with interchangeable fuse drawer for Fuse-links 5x20 mm or 6.3x32 mm, with or without voltage selector (step switch), Line filter in standard and medical version
- Quick connect terminals 4.8 x 0.8 mm

Approvals

- VDE Certificate Number: 40004665 (FKO, FKP, FKQ, FKR)
- UL File Number: E72928 (FKO, FKP, FKQ, FKR)

Characteristics

- All single elements are already wired
- The fuse drawer "Fingerrip" can be removed by hand
For added safety "Extra-Safe" fuse drawers are available
Fuse drawer meets requirements of medical standard IEC/EN 60601-1
The fuse drawer can only be opened with the aid of a tool
The fuseholder is accessible from the equipment front
- Suitable for use in equipment according to IEC/UL 60950
Suitable for use in medical equipment according to IEC/UL 60601-1

Other versions on request

- Variant with notch for V-Lock mating Cordsets

References

- Alternative: version without line filter [KEC](#)
- Alternative: Standard version

Weblinks

[pdf-datasheet](#), [html-datasheet](#), [General Product Information](#), [Approvals](#), [CE declaration of conformity](#), [RoHS](#), [CHINA-RoHS](#), [Mating Connectors](#), [e-Shop](#), [SCHURTER-Stock-Check](#), [Distributor-Stock-Check](#), [CAD-Drawings](#), [Accessories](#), [Detailed request for product](#)

Newly available variants corresponding to V-Lock mating cordset. The connector is equipped with a notch intended for use with the latching cordset. The cord latching system prevents against accidental removal of the cordset.

Technical Data

Ratings IEC	1 - 10A @ Ta 40 °C / 250 VAC; 50Hz	Appliance-Inlet/-Outlet	C14 acc. to IEC 60320, UL 498, CSA C22.2 no. 42 (for cold conditions) pin-temperature 70 °C, 10A, Protection Class I
Ratings UL/CSA	1 - 10A @ Ta 40 °C / 125 VAC; 60Hz	Fuseholder	1 or 2 pole, Shocksafe category PC2 acc. to IEC 60127-6, for fuse-links 5 x 20 or 6.3 x 32 mm
Leakage Current	standard < 0.5 mA (250 V / 60Hz) medical < 5 µA (250 V / 60 Hz)	Rated Power Acceptance @ Ta 23 °C	5 x 20: 2.5W (1 pole)/ 2W (2-pole) per pole 6.3 x 32: 3.15W (1 pole)/ 2.5W (2-pole) per pole
Dielectric Strength	> 1.7kVDC between L-N > 2.7kVDC between L/N-PE Test voltage (2 sec)	Power Acceptance @ Ta > 23°C	Admissible power acceptance at higher ambient temperature see derating curves
Allowable Operation Temp.	-25 °C to 85 °C	Voltage Selector	optional, step, 3 pos.
Climatic Category	25/085/21 acc. to IEC 60068-1	Line Filter	Standard and Medical Version, IEC 60939, UL 1283, CSA C22.2 no. 8 Technical Details
Degree of Protection	from front side IP 40 acc. to IEC 60529	MTBF	> 1'700'000h acc. to MIL-HB-217 F
Protection Class	Suitable for appliances with protection class I acc. to IEC 61140		
Terminal	Quick connect terminals 4.8 x 0.8 mm		
Panel Thickness s	Screw: max 8 mm Mounting screw torque max 0.5Nm		
Material: Housing	Thermoplastic, black, UL 94V-0		

Dimension

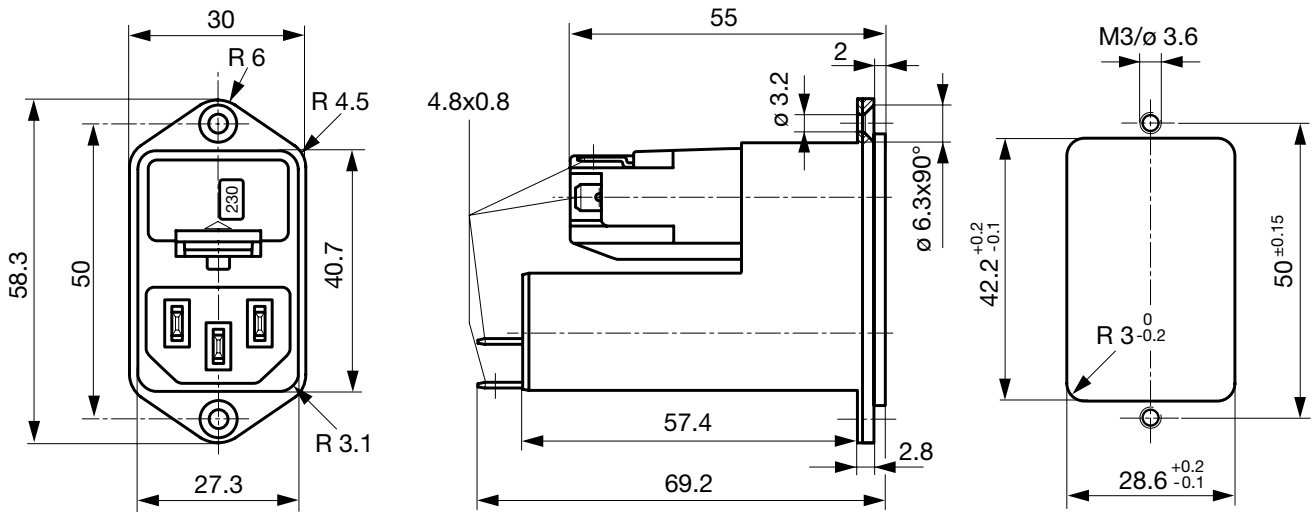

Technical Data of Filter-Components

Rated Current [A]	Filter-Type	Inductances L [mH]	Capacitance CX [nF]	Capacitance CY [nF]	R [MΩ]
1	Standard Version	2 x 10	68	2.2	-
2	Standard Version	2 x 4	68	2.2	-
4	Standard Version	2 x 1.5	68	2.2	-
6	Standard Version	2 x 0.8	68	2.2	-
10	Standard Version	2 x 0.3	68	2.2	-
1	Medical Version (M5)	2 x 10	68	-	1
2	Medical Version (M5)	2 x 4	68	-	1
4	Medical Version (M5)	2 x 1.5	68	-	1
6	Medical Version (M5)	2 x 0.8	68	-	1
10	Medical Version (M5)	2 x 0.3	68	-	1
10	Standard and Medical Version	2 x 0.3	68	2.2	1

Diagrams

Standard version with voltage selector

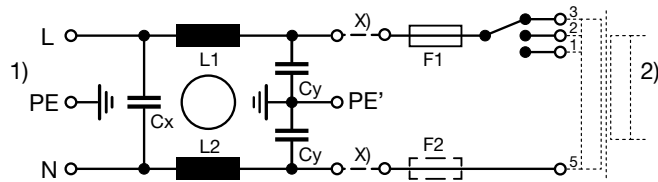

x) external connection to be made by the customer
1) Line
2) Load

Medical version (M5) with voltage selector

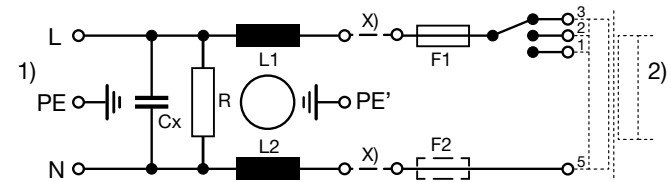

x) external connection to be made by the customer
1) Line
2) Load

Derating Curves

Fuses

5 x 20 mm (1-pole)

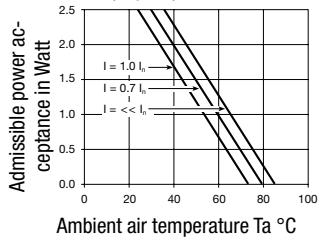

Fuses

5 x 20 mm (2-pole, per pole)

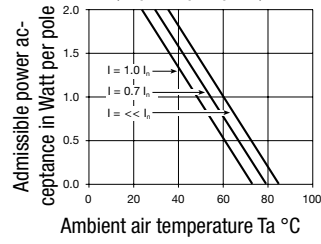

Fuses

6.3 x 32 mm (1-pole)

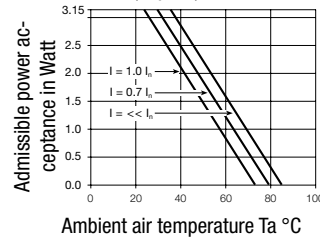

Fuses

6.3 x 32 mm (2-pole, per pole)

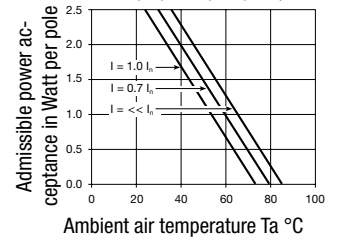

Attenuation Loss

--- differential mode _____ common mode

Standard version

1 A

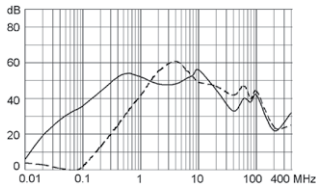

2 A

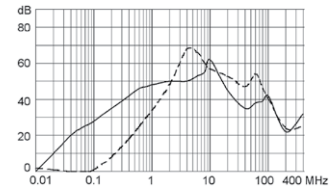

4 A

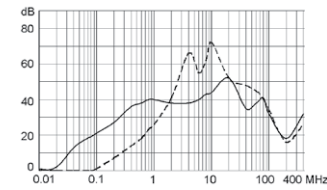

6 A

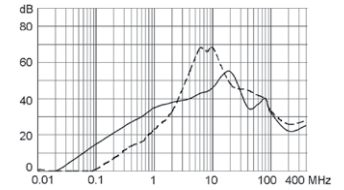

10 A

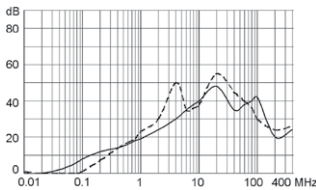

Medical version (M5)

1 A

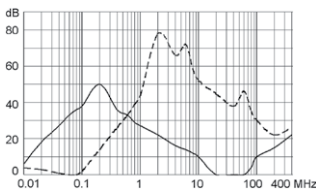

2 A

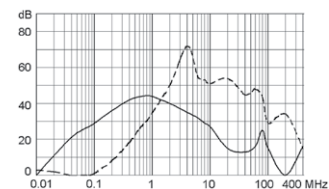

4 A

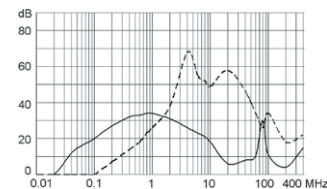

6 A

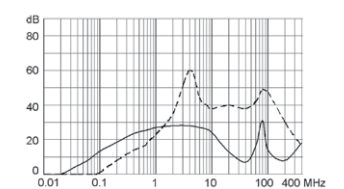

10 A

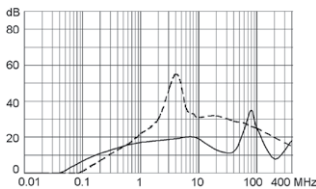

All Variants

Rated Current [A]	Filter-Type	Fuseholder	Voltage Selector	Order Number
1	Standard Version	1-pole	-	4303.5011
2	Standard Version	1-pole	-	4303.5012
4	Standard Version	1-pole	-	4303.5013
6	Standard Version	1-pole	-	4303.5014
10	Standard Version	1-pole	-	4303.5015
1	Standard Version	1-pole	3 pos.	4303.5031
2	Standard Version	1-pole	3 pos.	4303.5032
4	Standard Version	1-pole	3 pos.	4303.5033
6	Standard Version	1-pole	3 pos.	4303.5034
10	Standard Version	1-pole	3 pos.	4303.5035
1	Standard Version	2-pole	-	4303.5001
2	Standard Version	2-pole	-	4303.5002
4	Standard Version	2-pole	-	4303.5003
6	Standard Version	2-pole	-	4303.5004
10	Standard Version	2-pole	-	4303.5005
1	Standard Version	2-pole	3 pos.	4303.5021
2	Standard Version	2-pole	3 pos.	4303.5022
4	Standard Version	2-pole	3 pos.	4303.5023
6	Standard Version	2-pole	3 pos.	4303.5024
10	Standard Version	2-pole	3 pos.	4303.5025
1	Medical Version (M5)	2-pole	3 pos.	4303.5221
2	Medical Version (M5)	2-pole	3 pos.	4303.5223
4	Medical Version (M5)	2-pole	3 pos.	4303.5225
6	Medical Version (M5)	2-pole	3 pos.	4303.5227
10	Medical Version (M5)	2-pole	3 pos.	4303.5229

 Most Popular.

Availability for all products can be searched real-time: <http://www.schurter.com/en/Stock-Check/Stock-Check-SCHURTER>

Packaging unit 10 Pcs

Required Accessory

Description



Fusedrawer 3
Fusedrawer for Fuse Links 5x20 mm resp. 6.3x32 mm

Accessories

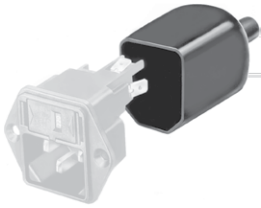

Assorted Covers
Rear Cover



Cord retaining kits
Cord retaining strain relief

Mating Outlets/Connectors

Category / Description



Appliance Outlet Overview complete

IEC Appliance Outlet F, Screw-on Mounting, Front Side, Solder Terminal	4787
IEC Appliance Outlet F, Snap-in Mounting, Front Side, Solder or Quick-connect Terminal	4788
IEC Appliance Outlet F or H, Screw-on Mounting, Front Side, Solder, PCB or Quick-connect Terminal	5091

Appliance Outlet further types to KFC

Connector Overview complete



IEC Connector C15A, Rewireable, Straight	0102
IEC Connector C15A, Rewireable, Straight	0102-G
IEC Connector C15A, Rewireable, Angled	0112
IEC Connector C13, Rewireable, Angled	4012
IEC Connector C13, Rewireable, Straight	4022

Connector further types to KFC

Mating Outlets/Connectors shuttered



Power Cord Overview complete

Overview Power Supply Cord with IEC Connector C13, V-Lock, straight	VAC13KS
---	---------

Power Cord further types to KFC