

IEC Appliance Inlet C14, Snap-in Mounting, Front Side, PCB terminals



Snap-in version



Approvals and Compliances

Description

- Panel Mount :
 Snap-in version from front side
- 1 Function :
- Appliance Inlet , Pin temperature 70 °C , Protection class I
- For PCB mounting

Other versions on request

- Types for enhanced glow wire test requirements acc. IEC 60695-2-12 and -13 for the use in unattended household equipment acc. IEC 60335-1

Weblinks

[pdf datasheet](#), [html-datasheet](#), [General Product Information](#), [Distributor-Stock-Check](#), [Accessories](#), [Detailed request for product](#)

Technical Data

Ratings IEC	10A / 250VAC; 50Hz
Ratings UL/CSA	15A / 250VAC; 60Hz
Dielectric Strength	> 2kVAC between L-N > 2kVAC between L/N-PE (1 min/50Hz)
Allowable Operation Temperature	-25 °C to 70 °C
IP-Protection	from front side IP 30 acc. to IEC 60529
Insulation cover	Suitable for appliances with protection class I acc. to IEC 61140
Terminal	For PCB mounting ;
Panel Thickness S	Snap-in: 1/1.2/1.5/2/2.5/3 mm
Material: Housing	Thermoplastic, black, UL 94V-0

appliance inlet/-outlet	C14 acc. to IEC 60320-1, UL 60320-1, CSA C22.2 no. 60320-1 (for cold conditions) pin-temperature 70 °C, 10A, Protection Class I
-------------------------	---

Approvals and Compliances

Detailed information on product approvals, code requirements, usage instructions and detailed test conditions can be looked up in [Details about Approvals](#)

Approvals



The approval mark is used by the testing authorities to certify compliance with the safety requirements placed on electronic products.

Approval Reference Type: 6130-56

Approval Logo	Certificates	Certification Body	Description
	VDE Approvals	VDE	Certificate Number: 40015595
	UL Approvals	UL	UL File Number: E96454
	CSA Approvals	CSA	CSA Certification Record: 38456
	CQC Approvals	CQC	CCC File Number: 2006010204174858



Product standards

Product standards that are referenced

Organization	Design	Standard	Description
	Designed according to	IEC 60320-1	Appliance couplers for household and similar general purposes
	Designed according to	UL 60320-1	Standard for Attachment Plugs and Receptacles
	Designed according to	CSA C22.2 no. 60320-1	General Use Receptacles, Attachment Plugs, and Similar Wiring Devices





Application standards

Application standards where the product can be used

Organization	Design	Standard	Description
	Designed for applications acc.	IEC/UL 60950	IEC 60950-1 includes the basic requirements for the safety of information technology equipment.
	Designed for applications acc.	IEC 60335-1	Safety of electrical appliances for household and similar purposes. Meets the requirements for appliances in unattended use. This includes the enhanced requirements of glow wire tests acc. to IEC 60695-2-12 and -13.

Compliances

The product complies with following Guide Lines

Identification	Details	Initiator	Description
	CE declaration of conformity	SCHURTER AG	The CE marking declares that the product complies with the applicable requirements laid down in the harmonisation of Community legislation on its affixing in accordance with EU Regulation 765/2008.
	RoHS	SCHURTER AG	EU Directive RoHS 2011/65/EU
	China RoHS	SCHURTER AG	The law SJ / T 11363-2006 (China RoHS) has been in force since 1 March 2007. It is similar to the EU directive RoHS.
	REACH	SCHURTER AG	On 1 June 2007, Regulation (EC) No 1907/2006 on the Registration, Evaluation, Authorization and Restriction of Chemicals 1 (abbreviated as "REACH") entered into force.

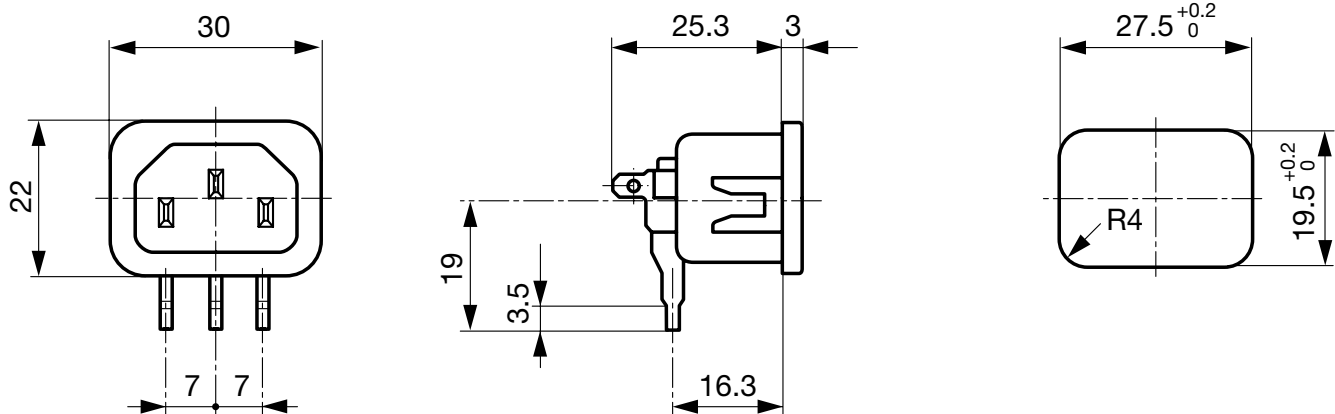
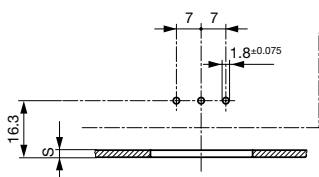
Dimensions [mm]**Drilling diagrams**

S: 1.0; 1.2; 1.5; 2.0; 2.5; 3.0 mm

All Variants

Panel mounting	Panel Thickness s [mm]	Order Number
Snap-in	1	6130.5610
Snap-in	1.2	6130.5612
Snap-in	1.5	6130.5615
Snap-in	2	6130.5620
Snap-in	2.5	6130.5625
Snap-in	3	6130.5630

Most Popular.

Availability for all products can be searched real-time: <https://www.schurter.com/en/Stock-Check/Stock-Check-SCHURTER>

Articles for enhanced glow wire test requirements acc. IEC 60695-2-12 and -13 can be ordered with ending ".15" (xxxx.xxxx.15). They are suitable for the use in unattended household equipment acc. IEC 60335-1.

Packaging unit 50 Pcs

Mating Outlets/Connectors

Category / Description



Appliance Outlet Overview complete

IEC Appliance Outlet F, Screw-on Mounting, Front Side, Solder Terminal	4787
IEC Appliance Outlet F, Snap-in Mounting, Front Side, Solder or Quick-connect Terminal	4788
IEC Appliance Outlet F or H, Screw-on Mounting, Front Side, Solder, PCB or Quick-connect Terminal	5091

[Appliance Outlet further types to 6130-56](#)



Connector Overview complete

4782 Mounting: Power Cord, 3 x 1 mm ² / 3 x 18 AWG, Cable, Connector: IEC C13	4782
4022 Mounting: Power Supply Cord, 3 x 1.5 mm ² , Screw clamps, Connector: IEC C13	4022
4785 Mounting: Power Cord, 3 x 1 mm ² / 3 x 18 AWG, Cable, Connector: IEC C13	4785
4300-06 Mounting: Power Cord, 3 x 1 mm ² / 3 x 18 AWG, Cable, Connector: IEC C13	4300-06
4012 Mounting: Power Supply Cord, 3 x 1.5 mm ² , Screw clamps, Connector: IEC C13	4012

[Connector further types to 6130-56](#)