

IEC Appliance Inlet C14 with Filter, Fuseholder 1- or 2-pole (5x20 mm or 6.3x32 mm), Line Switch 1- or 2-pole, Voltage Selector (Step)

Standard- or Medical-Filter



V-Lock



Fuse drawer must be ordered separately (see accessories).



Description

- Panel Mount:
Screw-on mounting from front side
- 5 Functions:
Appliance Inlet, Line Switch, Fuseholder with interchangeable fuse drawer for Fuse-links 5 x 20 mm or 6.3 x 32 mm, with or without voltage selector (step switch), Line filter in standard and medical version
- Quick connect terminals 4.8 x 0.8 mm

Approvals

- VDE Certificate Number: 40004665 (FKSO, FKSP, FKSU, FKSU)
- UL File Number: E72928 (FKSO, FKSP, FKSU, FKSU)

Characteristics

- All single elements are already wired
- The fuse drawer "Fingergrip" can be removed by hand
For added safety "Extra-Safe" fuse drawers are available
Fuse drawer meets requirements of medical standard IEC/EN 60601-1
The fuse drawer can only be opened with the aid of a tool
The fuseholder is accessible from the equipment front
- Qualified for use in equipment according IEC/EN 60950

References

Alternative: version without line filter [KD](#)

Weblinks

[pdf](#), [General Product Information](#), [Approvals](#), [RoHS](#), [CHINA-RoHS](#), [Mating Connectors](#), [e-Store](#), [SCHURTER-Stock-Check](#), [Distributor-Stock-Check](#), [Accessories](#), [Wire Harness](#)

Newly available variants corresponding to V-Lock mating cordset. The connector is equipped with a notch intended for use with the latching cordset. The cord latching system prevents against accidental removal of the cordset.

Technical Data

Ratings IEC	1 - 10A @ Ta 40 °C / 250VAC; 50Hz	Appliance-Inlet/-Outlet	C14 acc. to IEC/EN 60320-1, UL 498, CSA C22.2 no. 42 (for cold conditions) pin-temperature 70 °C, 10A, Protection Class 1
Ratings UL/CSA	1 - 10A @ Ta 40 °C / 125VAC; 60Hz	Fuseholder	1 or 2 pole, Shocksafe category PC2 acc. to IEC 60127-6, for fuse-links 5 x 20 or 6.3 x 32mm
Leakage Current	standard < 0.5mA (250V / 60Hz) medical < 5 µA (250 V / 60 Hz)	Rated Power Acceptance @ Ta 23 °C	5 x 20: 2.5W (1 pole)/ 2W (2-pole) per pole 6.3 x 32: 3.15W (1 pole)/ 2.5W (2-pole) per pole
Dielectric Strength	> 1.7kVDC between L-N > 2.7kVDC between L/N-PE Test voltage (2 sec)	Power Acceptance @ Ta > 23°C	Admissible power acceptance at higher ambient temperature see derating curves
Allowable Operation Temp.	-25 °C to 85 °C	Line Switch	Rocker switch 2-pole, non-illuminated, acc. to IEC 61058-1 Technical details
Climatic Category	25/085/21 acc. to IEC 60068-1	Voltage Selectors	optional, step, 2-4 digits
Degree of Protection	from front side IP 40 acc. to IEC 60529	Line Filter	Standard and Medical Version, IEC 60939, IEC 60601-1, UL 1283, UL 544, EN 133 200, CSA C22.2 no. 8 Technical details
Protection Class	Suitable for appliances with protection class 1 acc. to IEC 61140	MTBF	> 1'200'000h acc. to MIL-HB-217 F
Terminal	Quick connect terminals 4.8 x 0.8 mm		
Panel Thickness s	Screw: max 8 mm Mounting screw torque max 0.5Nm		
Material: Housing	Thermoplastic, black, UL 94V-0		

Dimensions
CD

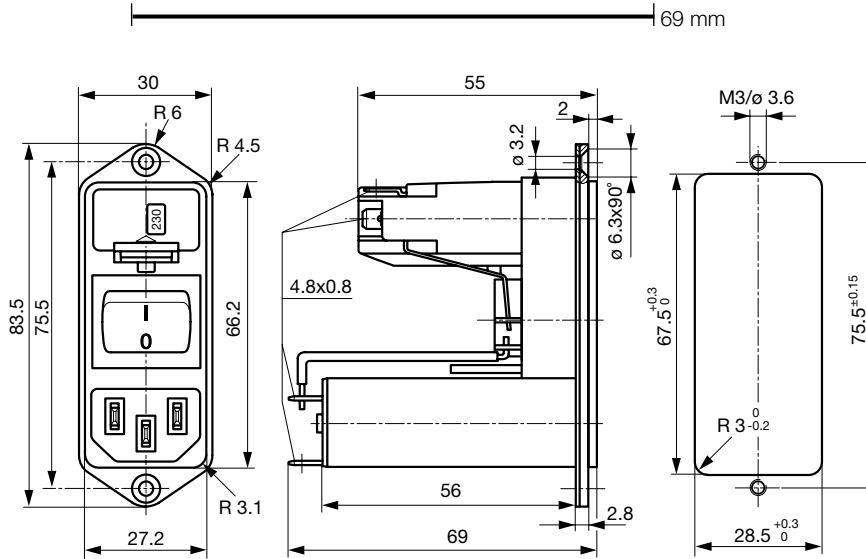

Technical Data of Filter-Components

Rated Current [A]	Filter-Type	Inductances L [mH]	Capacitance CX [nF]	Capacitance CY [nF]	R [MΩ]
1	Standard Version	2 x 10	68	2.2	-
2	Standard Version	2 x 4	68	2.2	-
4	Standard Version	2 x 1.5	68	2.2	-
6	Standard Version	2 x 0.8	68	2.2	-
10	Standard Version	2 x 0.3	68	2.2	-
1	Medical Version (M5)	2 x 10	68	-	1
2	Medical Version (M5)	2 x 4	68	-	1
4	Medical Version (M5)	2 x 1.5	68	-	1
6	Medical Version (M5)	2 x 0.8	68	-	1
10	Medical Version (M5)	2 x 0.3	68	-	1

Diagrams

Standard version with voltage selector

Medical version with voltage selector

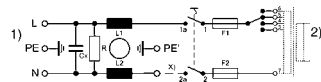
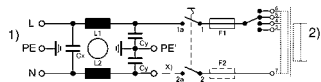

- 1) Line
- 2) Load
- x) External connection to be made by the customer

- 1) Line
- 2) Load
- x) External connection to be made by the customer

Derating Curves

Fuses
5 x 20 mm (1-pole)

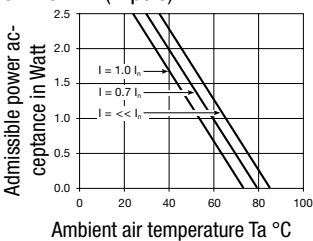

Fuses
5 x 20 mm (2-pole, per pole)

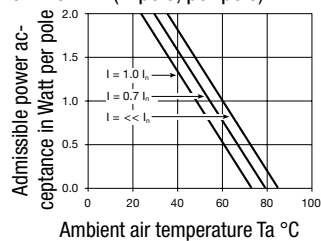

Fuses
6.3 x 32 mm (1-pole)

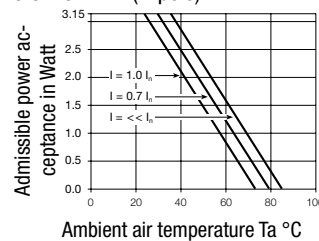

Fuses
6.3 x 32 mm (2-pole, per pole)

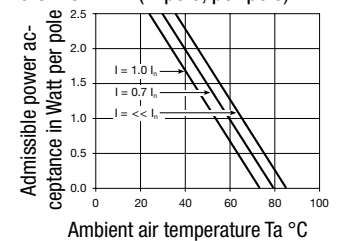

Attenuation Loss

Standard version

--- differential mode — common mode

1 A

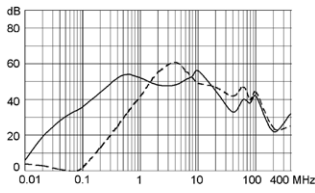

2 A

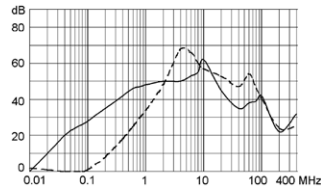

4 A

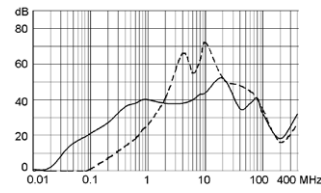

6 A

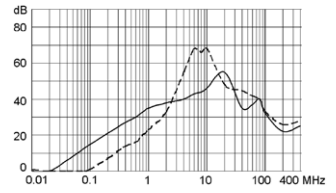

10 A

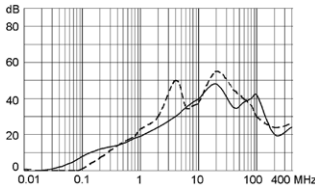

Medical version (M5)

1 A

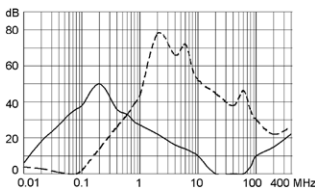

2 A

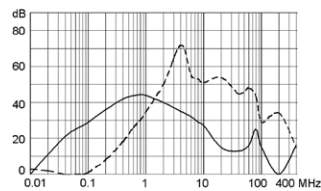

4 A

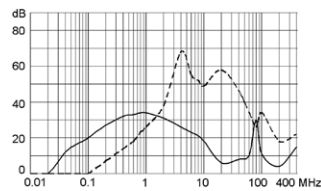

6 A

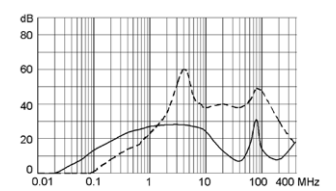

10 A

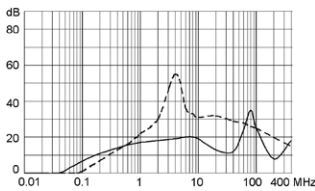

Variants

Type	Rated Current [A]	Filter-Type	Fuseholder	Line Switch	Voltage Selectors	Order Number
CD	1	Standard Version	1-pole	2-pole	-	CD11.1501.151
CD	2	Standard Version	1-pole	2-pole	-	CD21.1501.151
CD	4	Standard Version	1-pole	2-pole	-	CD31.1501.151
CD	6	Standard Version	1-pole	2-pole	-	CD41.1501.151
CD	10	Standard Version	1-pole	2-pole	-	CD61.1501.151
CD	1	Standard Version	1-pole	2-pole	2-4 digits	CD11.4501.151
CD	2	Standard Version	1-pole	2-pole	2-4 digits	CD21.4501.151
CD	4	Standard Version	1-pole	2-pole	2-4 digits	CD31.4501.151
CD	6	Standard Version	1-pole	2-pole	2-4 digits	CD41.4501.151
CD	10	Standard Version	1-pole	2-pole	2-4 digits	CD61.4501.151
CD	1	Standard Version	2-pole	2-pole	-	CD14.1101.151
CD	2	Standard Version	2-pole	2-pole	-	CD24.1101.151
CD	4	Standard Version	2-pole	2-pole	-	CD34.1101.151
CD	6	Standard Version	2-pole	2-pole	-	CD44.1101.151
CD	10	Standard Version	2-pole	2-pole	-	CD64.1101.151
CD	1	Standard Version	2-pole	2-pole	2-4 digits	CD14.4101.151
CD	2	Standard Version	2-pole	2-pole	2-4 digits	CD24.4101.151
CD	4	Standard Version	2-pole	2-pole	2-4 digits	CD34.4101.151

Type	Rated Current [A]	Filter-Type	Fuseholder	Line Switch	Voltage Selectors	Order Number
CD	6	Standard Version	2-pole	2-pole	2-4 digits	CD44.4101.151
CD	10	Standard Version	2-pole	2-pole	2-4 digits	CD64.4101.151
CD	1	Medical Version (M5)	2-pole	2-pole	2-4 digits	CDG4.4101.151
CD	2	Medical Version (M5)	2-pole	2-pole	2-4 digits	CDA4.4101.151
CD	4	Medical Version (M5)	2-pole	2-pole	2-4 digits	CDC4.4101.151
CD	6	Medical Version (M5)	2-pole	2-pole	2-4 digits	CDE4.4101.151
CD	10	Medical Version (M5)	2-pole	2-pole	2-4 digits	CDL4.4101.151

Packaging unit 10 Pcs

Required Accessory

Description

Fusedrawer 3
Fusedrawer for Fuse Links 5x20mm resp. 6.3x32mm



Fingergrip, 5 x 20, 2-pole, Voltage Selectors	4303.2014.00
Fingergrip, 5 x 20, 2-pole, Voltage Selectors, 100, 120, 220, 240	4303.2014.01
Fingergrip, 5 x 20, 2-pole, Voltage Selectors, 110, 150, 220	4303.2014.02
Fingergrip, 5 x 20, 2-pole, Voltage Selectors, 110, 220	4303.2014.03
...	...

Accessories

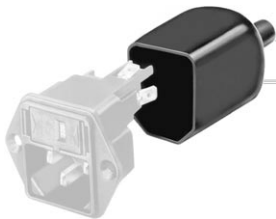

Assorted Covers
Rear Cover

0859.0077



Wire Harness
Wire harness for SCHURTER products



Cord retaining kits
Cord retaining strain relief

Flat head, A	4700.0001
--------------	-----------

Mating Outlets/Connectors

Category / Description

[Appliance Outlet Overview complete](#)



IEC Appliance Outlet F, Screw-on Mounting, Front Side, Solder Terminal	4787
IEC Appliance Outlet F, Snap-in Mounting, Front Side, Solder or Quick-connect Terminal	4788
IEC Appliance Outlet F or H, Screw-on Mounting, Front Side, Solder, PCB or Quick-connect Terminal	5091
IEC Appliance Outlet F or H, Screw-on Mounting, Front Side, Solder or Quick-connect Terminal	5092

[Appliance Outlet further types to CD](#)

[Connector Overview complete](#)



IEC Connector C15, Rewireable, Straight	0101
IEC Connector C15A, Rewireable, Straight	0102
IEC Connector C15A, Rewireable, Straight	0102-G
IEC Connector C15A, Rewireable, Angled	0112
IEC Connector C13, Rewireable, Angled	4012

[Connector further types to CD](#)

...

[Power Cord Overview complete](#)



Power Cord with IEC Connector C13, Angled	0311
Power Cord with IEC Connector C13, Angled	3011
Power Cord with IEC Connector C13, Angled	3012
Power Cord with IEC Connector C13, Angled	3013
Power Cord with IEC Connector C13	3020

[Power Cord further types to CD](#)

...