

Distributed by:

JAMECO[®]
ELECTRONICS

www.Jameco.com ♦ 1-800-831-4242

The content and copyrights of the attached
material are the property of its owner.

Jameco Part Number 466978

- **Precise Proportional Load Control**
- **Optically Isolated**
- **0-5 Vdc, 0-10 Vdc, 4-20mA Input Control Models**
- **Control Circuit Requires no Adjustment or Calibration**

The LPCV Linear Proportional Controllers control loads up to 110 Amps. Changes in the input signal linearly vary the firing angle of the thyristor load control device. Control circuitry and power switch are in the same package. The PS-120 (120V) and PS-240 (240V) power supplies are designed for use with the LPCV controller to provide the 20Vac required in addition to the control voltage.

MODEL NUMBERS	0-5 Vdc CONTROL	5LPCV2415	5LPCV2425	5LPCV2440	5LPCV2475	5LPCV24110
	0-10 Vdc CONTROL	10LPCV2415	10LPCV2425	10LPCV2440	10LPCV2475	10LPCV24110
	4-20 mA CONTROL	20LPCV2415	20LPCV2425	20LPCV2440	20LPCV2475	20LPCV24110

OUTPUT SPECIFICATIONS

	5LPCV2415	5LPCV2425	5LPCV2440	5LPCV2475	5LPCV24110
Operating Voltage (60 Hz) [Vrms]	20-300	20-300	20-300	20-300	20-300
Load Current Range [Arms]	.10-15	.10-25	.10-40	.15-75	.20-110
Transient Overvoltage [Vpk]	600	600	600	600	600
Max. Surge Current, (16.6ms) [Apk]	150	250	625	1000	1500
Max. Off-State Leakage Current @ Rated Voltage [mArms]	10	15	20	30	50
Thermal Resistance Junction to Case (R _{JC}) [°C/W]	1.48	1.02	0.63	0.31	0.28
Maximum I ² t for Fusing, (8.3 msec.) [A ² sec]	94	260	1620	4150	9340
Maximum Voltage Drop (100% On) [Vpk]	1.6	1.6	1.6	1.6	1.6
Minimum Off-State dv/dt [V/μsec]	200	200	200	200	200
Power Factor (Min.) with Max. Load	0.5	0.5	0.5	0.5	0.5

INPUT SPECIFICATIONS

	0-5 Vdc	0-10 Vdc	4-20 mA
Control Range (Nominal)	0-5 Vdc	0-10 Vdc	4-20 mA
Control Range Limits (Min/Msx)	-0.5/10 Vdc	-1.0/20 Vdc	-0.5/25 mA
Turn-On Threshold	.25 Vdc	0.5 Vdc	4.5 mA
Min. Input Impedance	12.7K Ohms	25K Ohms	460 Ohms

GENERAL NOTES

- ① All parameters at 25°C unless otherwise specified.
- ② Linear taper potentiometer 1-10K Ohm, 1/2 Watt.
- ③ 50Hz models available.
- ④ 20Vac must be in phase with load.

© 2003 CRYDOM CORP, Specifications subject to change without notice.

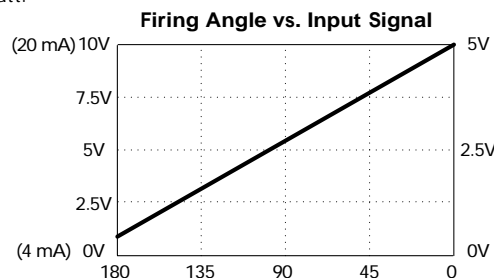

TYPICAL APPLICATIONS

- Infrared and Quartz Heaters
- Resistive Heating Elements
- Transformers
- Rectified DC Motors
- Thermal Forming Equipment
- Blow Molding Equipment
- Industrial Temperature Controllers
- Conveyor Speed Control
- Printing Applications

For recommended applications and more information contact:

USA: Sales Support (877) 502-5500 **Tech Support** (877) 702-7700 **FAX** (619) 710-8540

Crydom Corp, 2320 Paseo de las Americas, Ste. 201, San Diego, CA 92154

Email: sales@crydom.com **WEB SITE:** http://www.crydom.com

UK: +44 (0)1202 365070 • **FAX** +44 (0)1202 365090 Crydom International Ltd., 7 Cobham

Road, Ferndown Industrial Estate, Ferndown, Dorset BH21 7PE, **Email:** intsales@crydom.com.

GERMANY: +49 (0)180 3000 506



GENERAL SPECIFICATIONS

Dielectric Strength, Signal to Load	2500 Vrms
Dielectric Strength, Signal to Base	2500 Vrms
Ambient Operating Temperature Range	-30 to 80°C
Ambient Storage Temperature Range	-40 to 125°C

MECHANICAL SPECIFICATIONS

Weight: (typical)	6.0 oz. (175g)
Encapsulation:	Thermally Conductive Epoxy
Terminals:	8-32 Screws, .25 Inch Fastons

All dimensions are in inches (millimeters)

Screw Torque Requirements:

6-32 Screws - 10 in./lbs.,
8-32 and 10-32 Screws - 20 in./lbs.
(Screws dry without grease.)

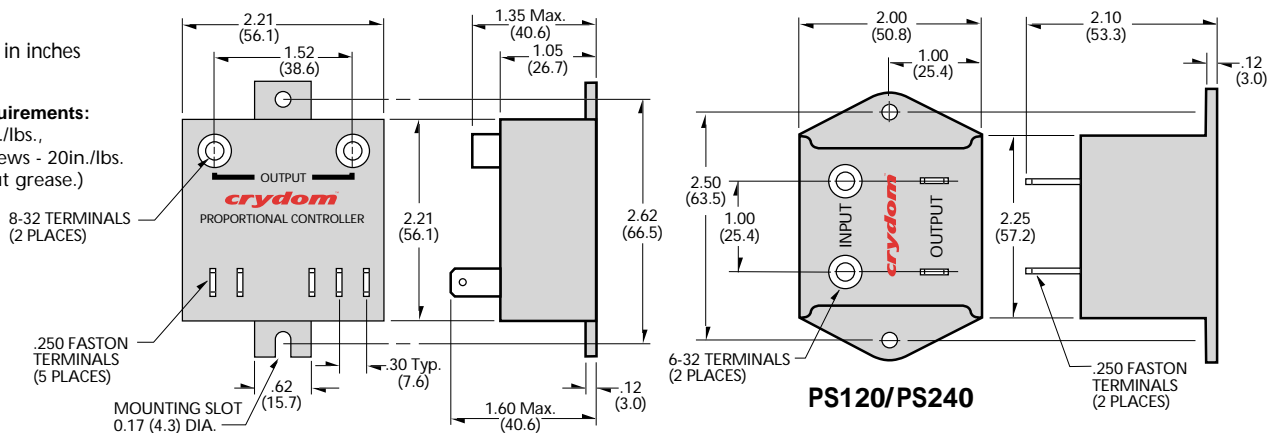

WIRING DIAGRAM

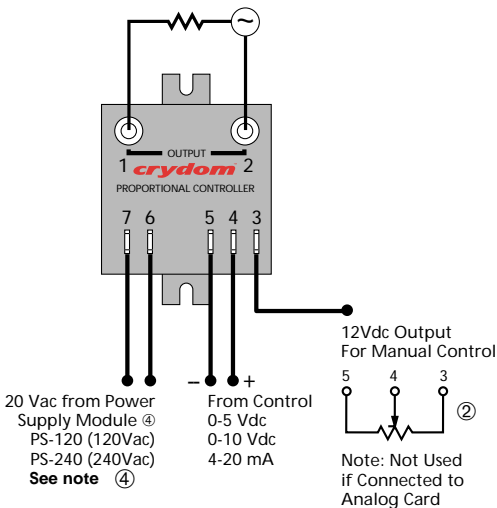

POWER SUPPLY SPECIFICATIONS ④

	PS120	PS240
Input Voltage 50/60Hz	120 Vac	240 Vac
Output Voltage 50/60Hz	20 Vac/100mA	20 Vac/100mA
Ambient Operating Temperature Range	-30 to 80°C	
Ambient Storage Temperature Range	-40 to 125°C	

MECHANICAL SPECIFICATIONS

Weight: (typical)	8.6 oz. (245g)
Encapsulation:	Thermally Conductive Epoxy
Terminals:	6-32 Screws, .25 Inch Fastons

©2003 CRYDOM CORP, Specifications subject to change without notice.

NOTE: UNSUITABLE APPLICATIONS

The LPCV is not suitable for some load control applications including, but not limited to the following:

- AC Motor Control
- Three Phase Motors
- Transformers requiring pure sine wave input
- Applications which cannot withstand thyristor noise
- Zero Crossing Applications

Please contact Crydom's application engineering department for additional information and specific application questions.

For recommended applications and more information contact:

USA: Sales Support (877) 502-5500 Tech Support (877) 702-7700 FAX (619) 710-8540

Crydom Corp, 2320 Paseo de las Americas, Ste. 201, San Diego, CA 92154

Email: sales@crydom.com WEB SITE: http://www.crydom.com

UK: +44 (0)1202 365070 • FAX +44 (0)1202 365090 Crydom International Ltd., 7 Cobham

Road, Ferndown Industrial Estate, Ferndown, Dorset BH21 7PE, Email: intsales@crydom.com.

GERMANY: +49 (0)180 3000 506

CURRENT DERATING CURVES

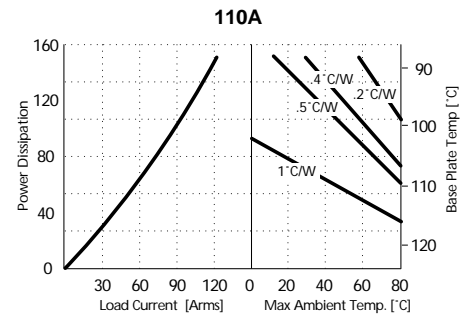
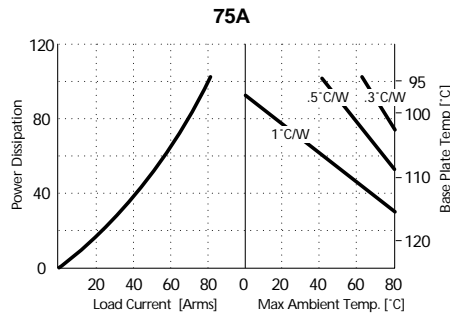
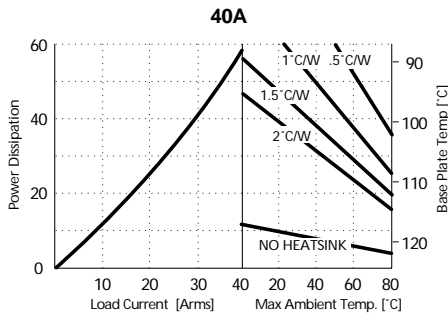
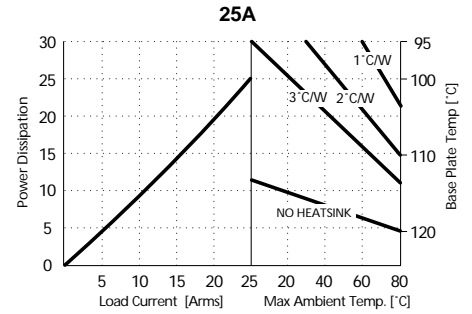
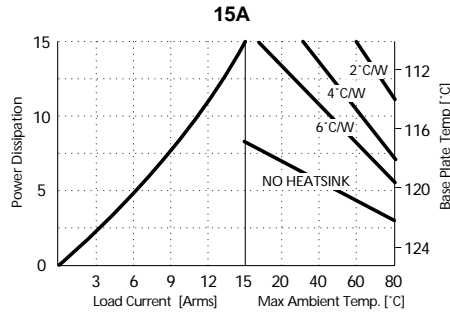

PERCENTAGE ON vs. INPUT VOLTAGE

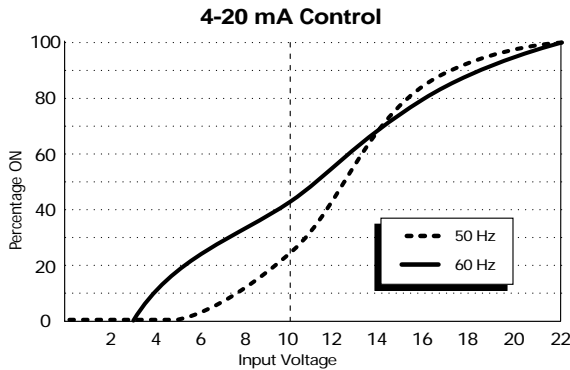
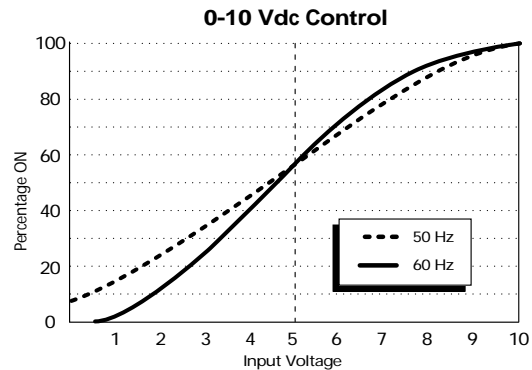
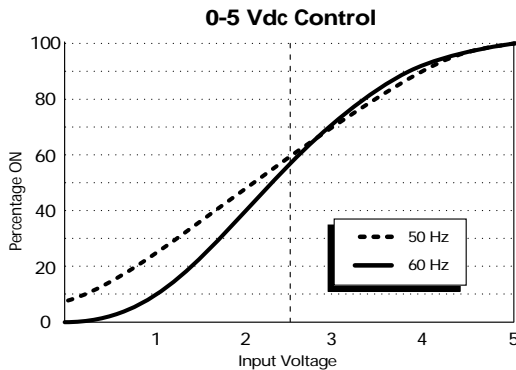

©2003 CRYDOM CORP, Specifications subject to change without notice.

