

Distributed by:

JAMECO[®]
ELECTRONICS

www.Jameco.com ♦ 1-800-831-4242

The content and copyrights of the attached
material are the property of its owner.

Jameco Part Number 467348

- **Zero Voltage and Random Turn-On Switching**
- **Panel Mount**
- **600V Transient Capability**
- **Internal Snubber**
- **110 & 125A Models Available**
- **Integrated Overvoltage Protection by Automatic Self Turn-On (Suffix P)**

Featuring state-of-the-art Surface Mount Technology, these SPST-NO relays deliver proven reliability in the most demanding proven applications. Output consists of an SCR AC switch and is available in zero-cross, random turn-on (phase controllable) and normally closed (Form B) versions with either AC or DC input (coil) control. Manufactured in Crydom's ISO 9001 Certified facility for optimum product performance and reliability.

MODEL NUMBERS	AC CONTROL	A1210	A1225	A1240	A2410	A2425	A2450	A2475	A2490
	DC CONTROL	D1210	D1225	D1240	D2410	D2425	D2450	D2475	D2490
OUTPUT SPECIFICATIONS ①									
Operating Voltage (47-63 Hz) [Vrms]		24-140	24-140	24-140	24-280	24-280	24-280	24-280	24-280
Max. Load Current ③ [Arms]		10	25	40	10	25	50	75	90
Min. Load Current, [mArms]		40	40	40	40	40	40	40	40
Transient Overvoltage [Vpk]		400	400	400	600	600	600	600	600
Max. Surge Current, (16.6ms) [Apk]		120	250	625	120	250	625	1000	1200
Max. On-State Voltage Drop @ Rated Current [Vpk]		1.6	1.6	1.6	1.6	1.6	1.6	1.6	1.6
Thermal Resistance Junction to Case (R _{θJC}) [°C/W]		1.48	1.02	0.63	1.48	1.02	0.63	0.31	0.28
Maximum I ² t for Fusing, (8.3 msec.) [A ² sec]		60	260	1620	60	260	1620	4150	6000
Max. Off-State Leakage Current @ Rated Voltage [mArms]		8	8	8	10	10	10	10	10
Min. Off-State dv/dt @ Max. Rated Voltage [V/μsec] ②		500	500	500	500	500	500	500	500
Max. Turn-On Time ④		1/2 Cycle (DC Control), 10.0 msec (AC Control)							
Max. Turn-Off Time		1/2 Cycle (DC Control), 40.0 msec (AC Control)							
Power Factor (Min.) with Max. Load		0.5	0.5	0.5	0.5	0.5	0.5	0.5	0.5

INPUT SPECIFICATIONS ①	DC CONTROL	AC CONTROL	AC CONTROL (E SUFFIX)
Control Voltage Range	3-32 Vdc	90-280 Vrms (60Hz)	18-36 Vrms
Max. Reverse Voltage	-32 Vdc	—	—
Max. Turn-On Voltage	3.0 Vdc	90 Vrms	18 Vrms
Min. Turn-Off Voltage	1.0 Vdc	10 Vrms	4.0 Vrms
Nominal Input Impedance	1500 Ohms	60K Ohms	9.0K Ohms
Typical Input Current	3.4mA @ 5 Vdc, 20mA @ 28Vdc	2mA @ 120 Vrms, 4mA @ 240 Vrms	3mA @ 24 Vrms

GENERAL NOTES

- ① All parameters at 25° C unless otherwise specified.
- ② Off-State dv/dt test method per EIA/NARM standard RS-443, paragraph 13.11.1
- ③ Heat sinking required, for derating curves see page 3.
- ④ Turn-on time for random turn-on versions is 0.02 msec (DC Control Models).

© 2003 CRYDOM CORP, Specifications subject to change without notice.



GENERAL SPECIFICATIONS

Dielectric Strength 50/60Hz Input/Output/Base	4000 Vrms
Insulation Resistance (Min.) @ 500 Vdc	10 ⁹ Ohm
Max. Capacitance Input/Output	8 pF
Ambient Operating Temperature Range	-40 to 80°C
Ambient Storage Temperature Range	-40 to 125°C

MECHANICAL SPECIFICATIONS

Weight: (typical)	3.0 oz. (86.5g)
Encapsulation:	Thermally Conductive Epoxy
Terminals:	Screws and Saddle Clamps Furnished, Unmounted

AVAILABLE OPTIONS

- B** Normally Closed (Form B)
Example: **D2450-B, A2450-B**
- E** 24 Vac Input (18-36 Vac)
Example: **A2450E**
- F** Faston Terminals (Up to 50A Models)
Example: **D1225F**
- G** Input Status LED.
Agencies Approval Pending
Example: **D2450G**
Note: Control Voltage Range 4.5-32Vdc
for DC Control Models.
- P** Internal Overvoltage Protection.
Relay Will Self Trigger Between
450-600 Vpk. Not Suitable For Capacitive Loads.
Not Available with -B Option
Agencies Approval Pending.
Example: **D2425P**
- 4D** 400 Hz Operation
10-50 Amp Models Only
Zero Cross Switching Only
Example: **4D2450**
- 10** Random Turn-On (AC & DC Control)
Phase Controllable (DC Control)
Example: **D2450-10**
- H** Heat Transfer Pad (Attached)
Example: **D2450H**

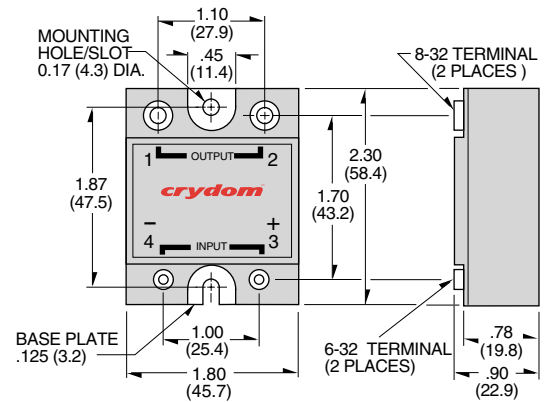

Screw Torque Requirements:
6-32 Screws - 10 in. lbs.,
8-32 and 10-32 Screws - 20in. lbs.
(Screws dry without grease.)

Fastons:
Single pair (up to 25A)
Double pair* (up to 50A).
***Caution: User must connect to both pairs**

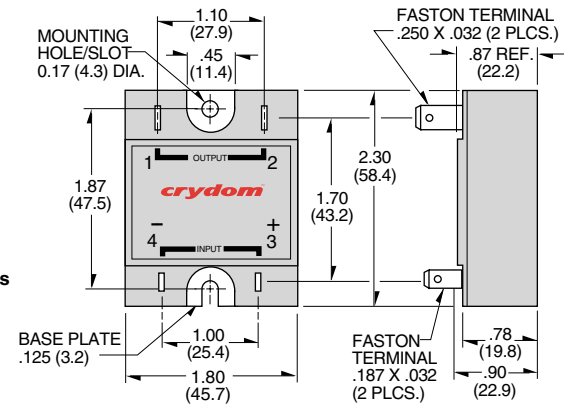

All dimensions are in inches (millimeters)

Ordering System: Combination of the suffixes should be made in the following order:
EFPG-10.
Example: **A2450EFPG-10**

Crydom Heat Sinks offer excellent thermal management and are perfectly matched to the load current ratings of Crydom panel mount relays. Request Crydom's Heat Sink specification sheet for all the details.

© 2003 CRYDOM CORP, Specifications subject to change without notice.

APPROVALS

UL E116949
CSA LR81689
VDE 10143 UG (Not Applicable: -B and 4D)



CURRENT DERATING CURVES

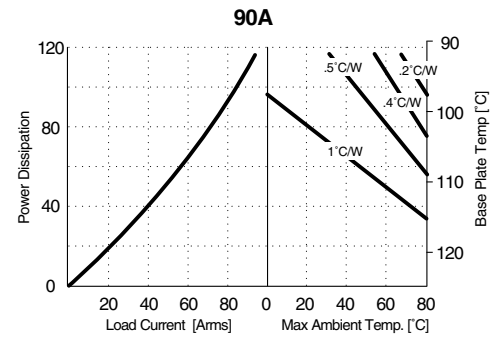
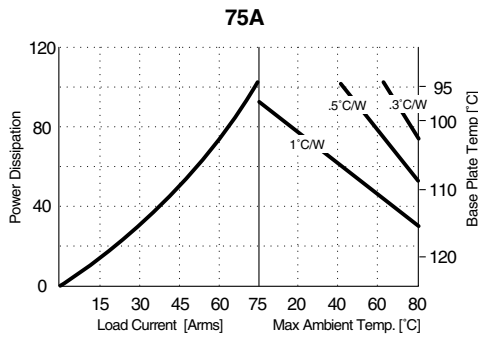
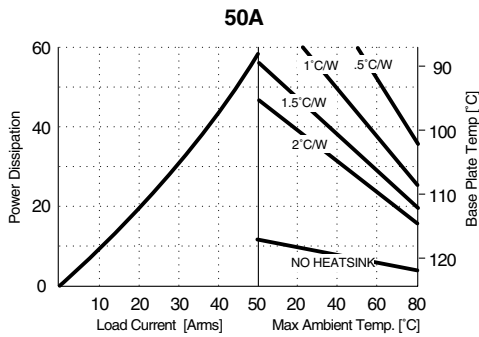
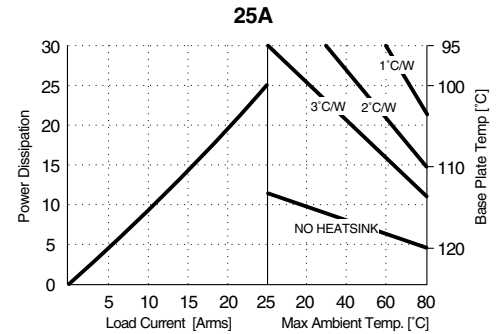
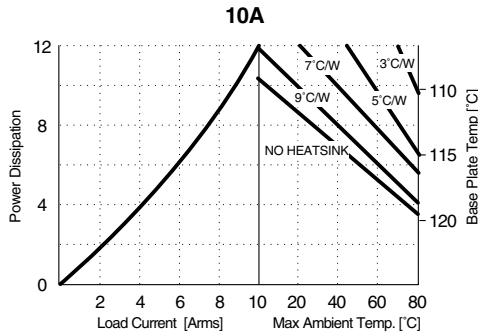

© 2003 CRYDOM CORP, Specifications subject to change without notice.

