

Distributed by:

**JAMECO**<sup>®</sup>  
ELECTRONICS

**www.Jameco.com ♦ 1-800-831-4242**

The content and copyrights of the attached  
material are the property of its owner.

Jameco Part Number 2001630

## High voltage ultrafast diode

### Main product characteristics

$I_{F(AV)}$	2 A
$V_{RRM}$	1200 V
$T_j$	175°C
$V_F$ (typ)	1.0 V
$t_{rr}$ (max)	75 ns

### Features and benefits

- Low forward voltage drop
- High reliability
- High surge current capability
- Soft switching for reduced EMI disturbances
- Planar technology

### Description

The STTH212, which is using ST ultrafast high voltage planar technology, is specially suited for free-wheeling, clamping, snubbing, demagnetization in power supplies and other power switching applications.

Housed in axial, SMB, and SMC packages, this diode will reduce the losses in high switching frequency operations.

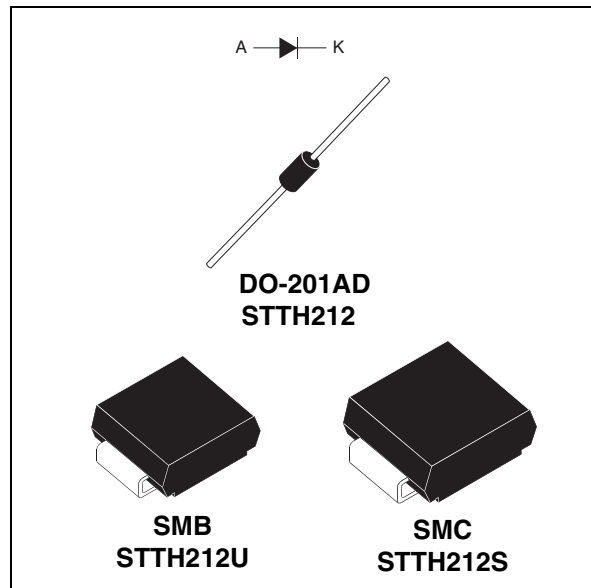

### Order codes

Part Number	Marking
STTH212	STTH212
STTH212RL	STTH212
STTH212U	U22
STTH212S	S12

# 1 Electrical characteristics

**Table 1. Absolute Ratings (limiting values)**

Symbol	Parameter		Value	Unit	
$V_{RRM}$	Repetitive peak reverse voltage		1200	V	
$V_{(RMS)}$	RMS voltage		850	V	
$I_{F(AV)}$	Average forward current $\delta = 0.5$	DO-201AD	$T_1 = 105^\circ\text{C}$	2	A
		SMB	$T_1 = 90^\circ\text{C}$		
		SMC	$T_1 = 105^\circ\text{C}$		
$I_{F(RMS)}$	RMS forward current	DO-201AD, SMB, SMC		10	A
$I_{FSM}$	Forward surge current $t_p = 8.3\text{ms}$	DO-201AD, SMB, SMC		40	A
$T_{stg}$	Storage temperature range		-50 to + 175	$^\circ\text{C}$	
$T_j$	Maximum operating junction temperature		175	$^\circ\text{C}$	

**Table 2. Thermal parameters**

Symbol	Parameter		Value	Unit	
$R_{th(j-l)}$	Junction to lead	L = 10 mm	DO-201AD	20	$^\circ\text{C/W}$
			SMB	25	
			SMC	20	
$R_{th(j-a)}$	Junction to ambient	L = 10 mm	DO-201AD	75	$^\circ\text{C/W}$

**Table 3. Static Electrical Characteristics**

Symbol	Parameter	Test conditions		Min.	Typ	Max.	Unit
$I_R$	Reverse leakage current	$T_j = 25^\circ\text{C}$	$V_R = V_{RRM}$			10	$\mu\text{A}$
		$T_j = 125^\circ\text{C}$				100	
$V_F$	Forward voltage drop	$T_j = 25^\circ\text{C}$	$I_F = 2\text{A}$			1.75	V
		$T_j = 125^\circ\text{C}$			1.07	1.50	
		$T_j = 150^\circ\text{C}$			1.0	-	

To evaluate the conduction losses use the following equation:  $P = 1.26 \times I_{F(AV)} + 0.12 I_{F(RMS)}^2$

**Table 4. Dynamic Electrical Characteristics**

Symbol	Parameter	Test conditions		Min.	Typ	Max.	Unit
$t_{rr}$	Reverse recovery time	$T_j = 25^\circ\text{C}$	$I_F = 1\text{A}$ $di_F/dt = -100\text{ A}/\mu\text{s}$ $V_R = 30\text{V}$			75	ns
$t_{fr}$	Forward recovery time	$T_j = 25^\circ\text{C}$	$I_F = 2\text{A}$ $di_F/dt = 50\text{ A}/\mu\text{s}$ $V_{FR} = 1.1 \times V_{Fmax}$			500	ns
$V_{FP}$	Forward recovery voltage					30	V

**Figure 1. Conduction losses versus average forward current**

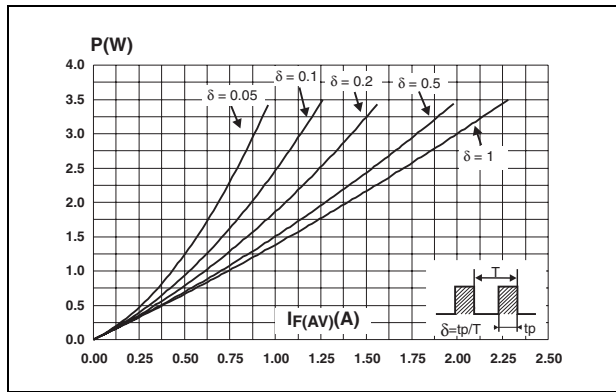

**Figure 2. Forward voltage drop versus forward current**

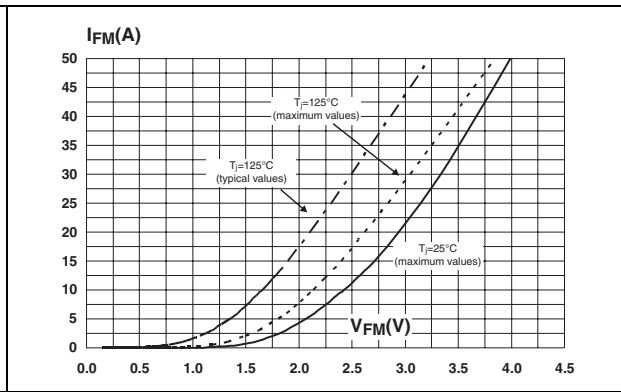

**Figure 3. Relative variation of thermal impedance junction to ambient versus pulse duration (Epoxy printed circuit board FR4,  $L_{Leads} = 10\text{mm}$ )**

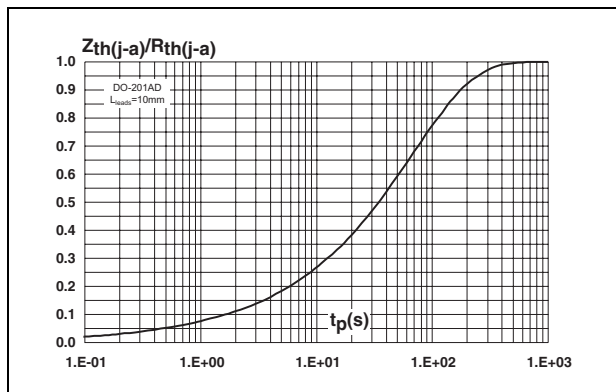

**Figure 4. Relative variation of thermal impedance junction to ambient versus pulse duration (Epoxy printed circuit board FR4,  $S_{CU} = 1\text{cm}^2$ )**

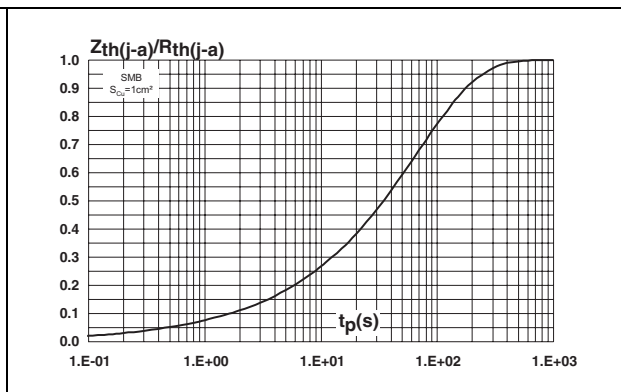

**Figure 5. Relative variation of thermal impedance junction to ambient versus pulse duration (Epoxy printed circuit board FR4,  $S_{CU} = 1\text{cm}^2$ )**

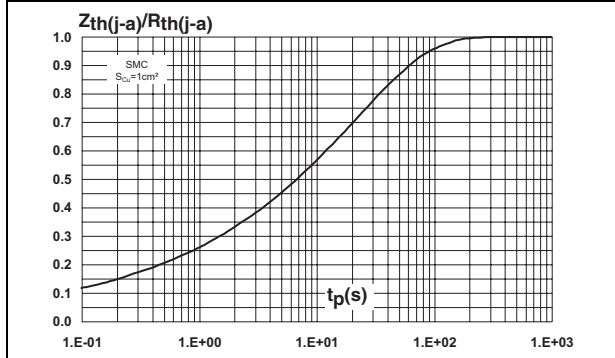

**Figure 6. Reverse recovery current versus  $di_F/dt$  (typical values)**

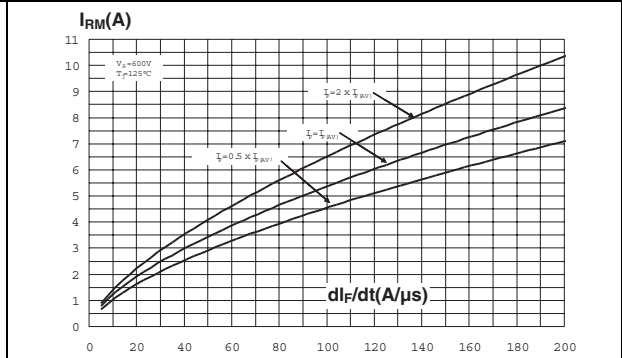

**Figure 7. Reverse recovery time versus  $di_F/dt$  (typical values)**

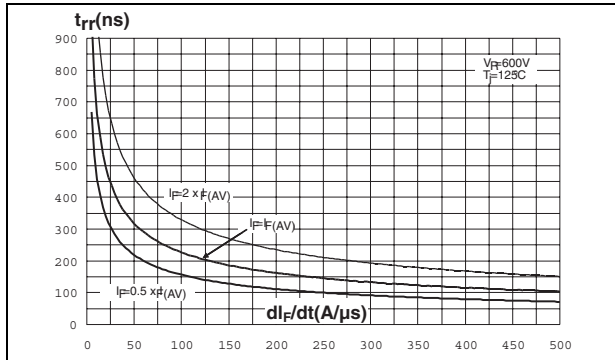

**Figure 8. Reverse recovery charges versus  $di_F/dt$  (typical values)**

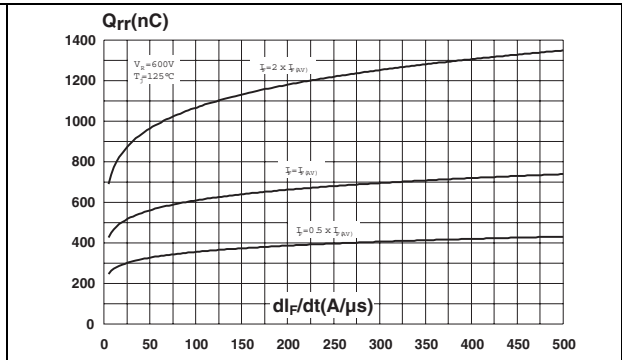

**Figure 9. Softness factor versus  $di_F/dt$  (typical values)**

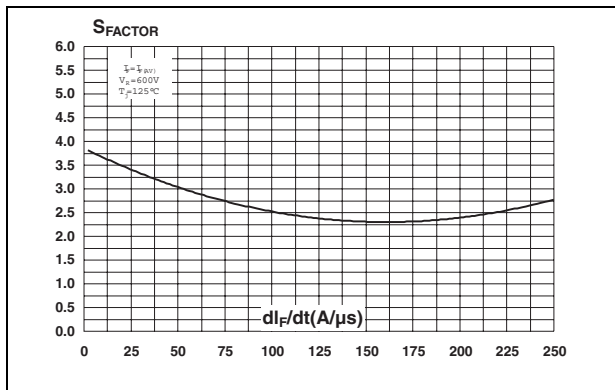

**Figure 10. Relative variations of dynamic parameters versus junction temperature**

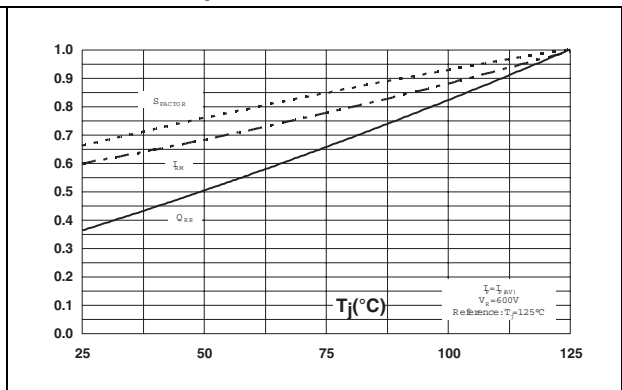

Figure 11. Transient peak forward voltage versus  $di_F/dt$  (typical values)

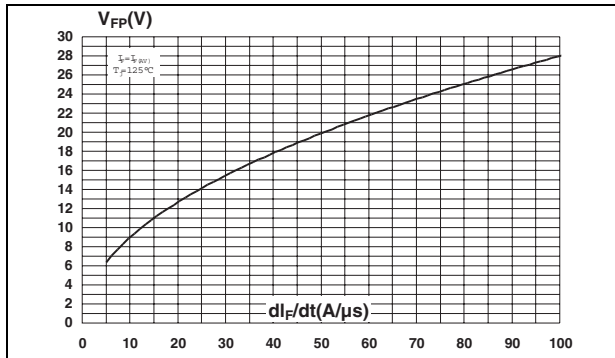

Figure 12. Forward recovery time versus  $di_F/dt$  (typical values)

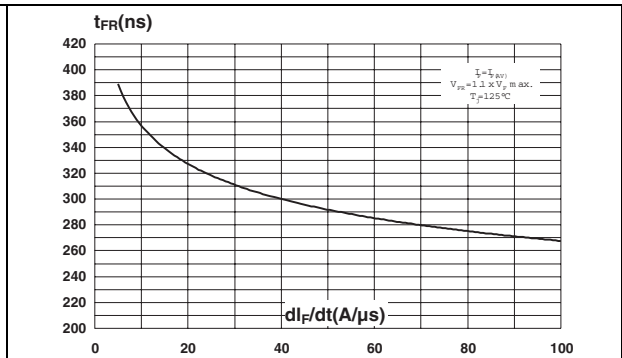

Figure 13. Junction capacitance versus reverse voltage applied (typical values)

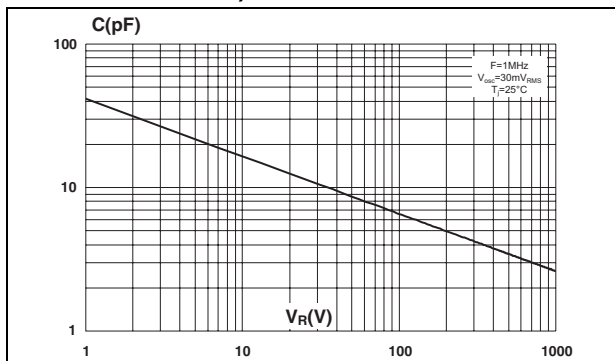

Figure 14. Thermal resistance versus lead length

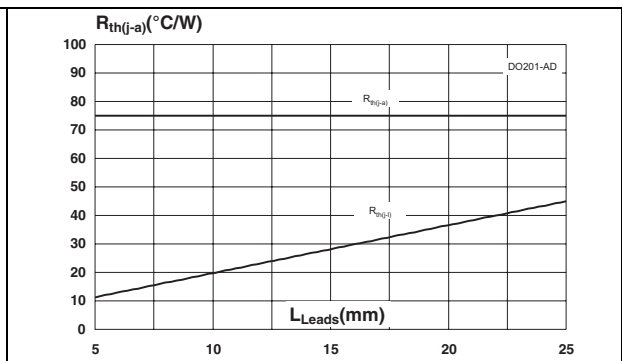

Figure 15. Thermal resistance junction to ambient versus copper surface under each lead (Epoxy printed circuit board FR4,  $e_{Cu} = 35\mu m$ )

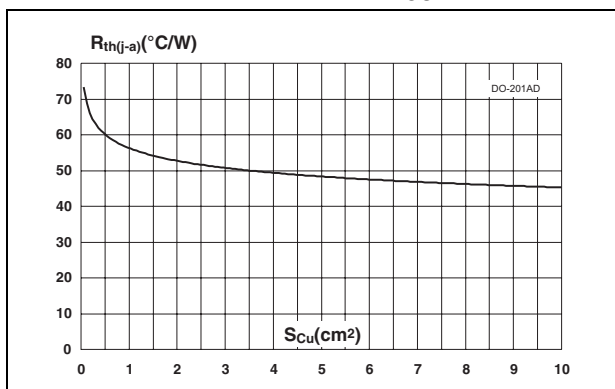
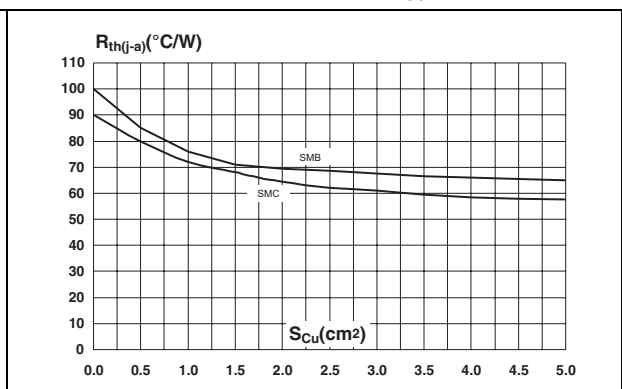

Figure 16. Thermal resistance junction to ambient versus copper surface under each lead (Epoxy printed circuit board FR4,  $e_{Cu} = 35\mu m$ )



## 2 Package mechanical data

**Table 5. SMB dimensions**

REF.	DIMENSIONS			
	Millimeters		Inches	
	Min.	Max.	Min.	Max.
A1	1.90	2.45	0.075	0.096
A2	0.05	0.20	0.002	0.008
b	1.95	2.20	0.077	0.087
c	0.15	0.41	0.006	0.016
E	5.10	5.60	0.201	0.220
E1	4.05	4.60	0.159	0.181
D	3.30	3.95	0.130	0.156
L	0.75	1.60	0.030	0.063

**Figure 17. SMB references to dimensions table**      **Figure 18. SMB footprint dimensions (in millimetres)**

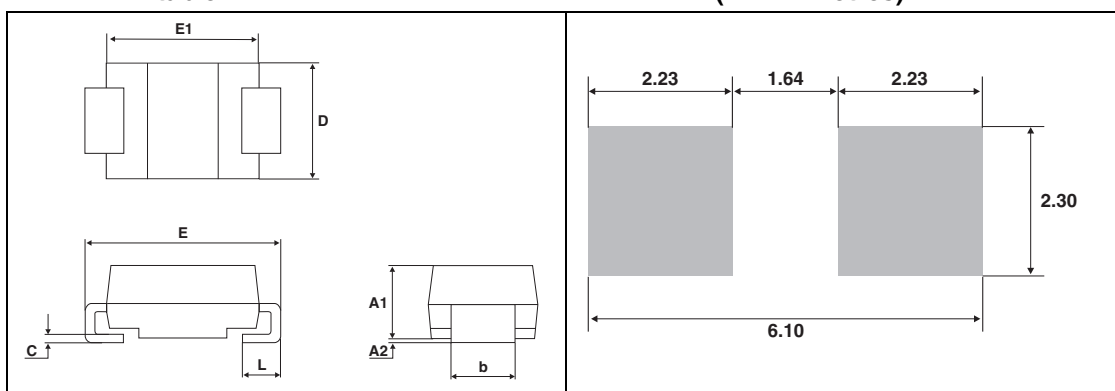

**Table 6. SMC dimensions**

REF.	DIMENSIONS			
	Millimeters		Inches	
	Min.	Max.	Min.	Max.
A1	1.90	2.45	0.075	0.096
A2	0.05	0.20	0.002	0.008
b	2.90	3.2	0.114	0.126
c	0.15	0.41	0.006	0.016
E	7.75	8.15	0.305	0.321
E1	6.60	7.15	0.260	0.281
E2	4.40	4.70	0.173	0.185
D	5.55	6.25	0.218	0.246
L	0.75	1.60	0.030	0.063

**Figure 19. SMC references to dimensions table**      **Figure 20. SMC footprint dimensions (in millimetres)**

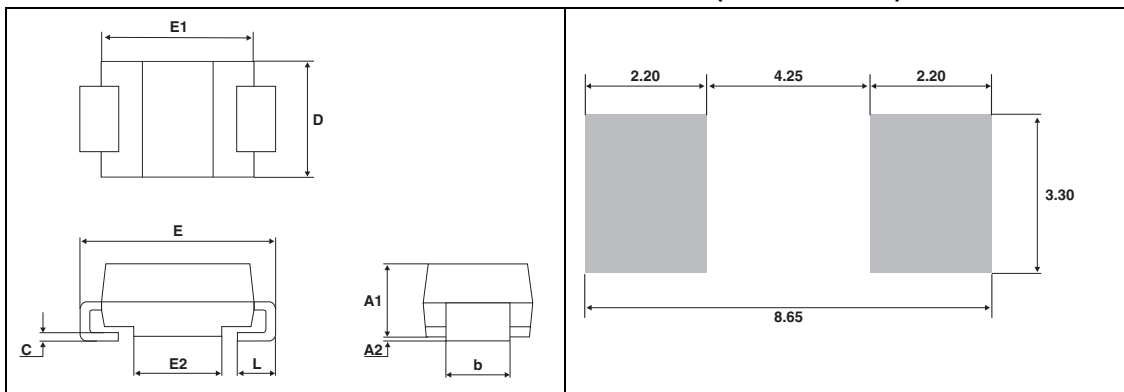

**Table 7. DO-201AD dimensions**

REF.	DIMENSIONS			
	Millimeters		Inches	
	Min.	Max.	Min.	Max.
A	-	9.5	-	0.37
B	25.4	-	1.00	-
C	-	5.3	-	0.21
D	-	1.3	-	0.051
E	-	1.25	-	0.048

Note: 1 The lead diameter *D* is not controlled over zone *E*.

2 The minimum length which must stay straight between the right angles after bending is 15 mm (0.59 inch).

### 3 Ordering information

Part Number	Marking	Package	Weight	Base qty	Delivery mode
STTH212	STTH212	DO-201AD	1.12 g	600	Ammopack
STTH212RL	STTH212			1900	Tape & reel
STTH212U	U22	SMB	0.11 g	2500	Tape & reel
STTH212S	S12	SMC	0.243 g	2500	Tape & reel

### 4 Revision history

Date	Revision	Description of Changes
28-Jun-2005	1	First issue.

Information furnished is believed to be accurate and reliable. However, STMicroelectronics assumes no responsibility for the consequences of use of such information nor for any infringement of patents or other rights of third parties which may result from its use. No license is granted by implication or otherwise under any patent or patent rights of STMicroelectronics. Specifications mentioned in this publication are subject to change without notice. This publication supersedes and replaces all information previously supplied. STMicroelectronics products are not authorized for use as critical components in life support devices or systems without express written approval of STMicroelectronics.

The ST logo is a registered trademark of STMicroelectronics.  
All other names are the property of their respective owners

© 2005 STMicroelectronics - All rights reserved

STMicroelectronics group of companies

Australia - Belgium - Brazil - Canada - China - Czech Republic - Finland - France - Germany - Hong Kong - India - Israel - Italy - Japan -  
Malaysia - Malta - Morocco - Singapore - Spain - Sweden - Switzerland - United Kingdom - United States of America

[www.st.com](http://www.st.com)

