

Turbo 2 ultrafast - high voltage rectifier

Main product characteristics

$I_{F(AV)}$	5 A
V_{RRM}	600 V
T_j	175° C
V_F (typ)	1.1 V
t_{rr} (max)	30 ns

Features and benefits

- Ultrafast switching
- Low reverse current
- Low thermal resistance
- Reduces conduction and switching losses
- Insulated package TO-220FPAC
 - Insulated voltage: 2500 V_{RMS}
 - Typical package capacitance: 12 pF

Description

The STTH506 uses ST Turbo2 600V technology. This device is specially suited for use in switching power supplies, and industrial applications.

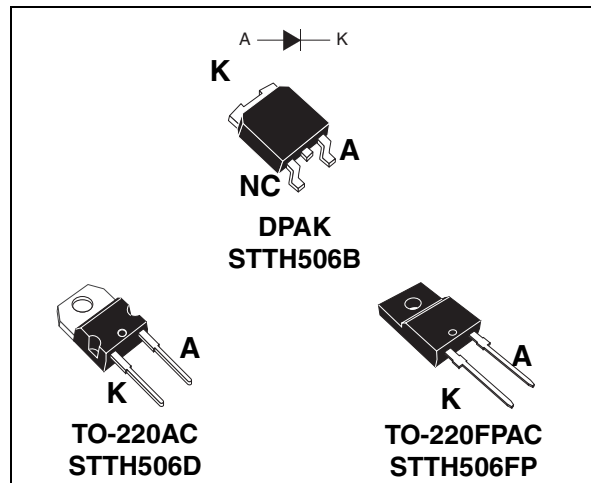

Order codes

Part Number	Marking
STTH506B	STTH506B
STTH506B-TR	STTH506B
STTH506D	STTH506D
STTH506FP	STTH506FP

Table 1. Absolute ratings (limiting values per diode at 25° C, unless otherwise specified)

Symbol	Parameter		Value	Unit
V_{RRM}	Repetitive peak reverse voltage		600	V
$I_{F(RMS)}$	RMS forward current	TO-220AC, TO220FPAC	20	A
		DPAK	10	A
$I_{F(AV)}$	Average forward current, $\delta = 0.5$	$T_c = 145^\circ\text{C}$ TO-220AC, DPAK	5	A
		$T_c = 120^\circ\text{C}$ TO-220FPAC	5	A
I_{FSM}	Surge non repetitive forward current	$t_p = 10\text{ ms}$ Sinusoidal TO-220AC, TO220FPAC	70	A
		DPAK	55	A
T_{stg}	Storage temperature range		-65 to + 175	°C
T_j	Maximum operating junction temperature ⁽¹⁾		175	°C

1. $\frac{dP_{tot}}{dT_j} < \frac{1}{R_{th(j-a)}}$ thermal runaway condition for a diode on its own heatsink

1 Characteristics

Table 2. Thermal parameters

Symbol	Parameter		Value	Unit
$R_{th(j-c)}$	Junction to case	TO-220AC, DPAK	3.5	°C/W
		TO-220FPAC	6	

Table 3. Static electrical characteristics

Symbol	Parameter	Test conditions		Min.	Typ	Max.	Unit
$I_R^{(1)}$	Reverse leakage current	$T_j = 25^\circ\text{C}$	$V_R = V_{RRM}$			5	μA
		$T_j = 150^\circ\text{C}$			13	130	
$V_F^{(2)}$	Forward voltage drop	$T_j = 25^\circ\text{C}$	$I_F = 5\text{ A}$			1.85	V
		$T_j = 150^\circ\text{C}$			1.10	1.40	

1. Pulse test: $t_p = 5\text{ ms}$, $\delta < 2\%$
2. Pulse test: $t_p = 380\ \mu\text{s}$, $\delta < 2\%$

To evaluate the conduction losses use the following equation:

$$P = 1.07 \times I_{F(AV)} + 0.066 I_F^2(RMS)$$

Table 4. Dynamic characteristics

Symbol	Parameter	Test conditions	Min.	Typ	Max.	Unit
t_{rr}	Reverse recovery time	$I_F = 0.5\text{ A}$, $I_{rr} = 0.25\text{ A}$, $I_R = 1\text{ A}$, $T_j = 25^\circ\text{C}$			30	ns
		$I_F = 1\text{ A}$, $di_F/dt = -50\text{ A}/\mu\text{s}$, $V_R = 30\text{ V}$, $T_j = 25^\circ\text{C}$		35	50	
I_{RM}	Reverse recovery current	$I_F = 5\text{ A}$, $di_F/dt = -100\text{ A}/\mu\text{s}$, $V_R = 400\text{ V}$, $T_j = 25^\circ\text{C}$		3.5	5	
t_{fr}	Forward recovery time	$I_F = 5\text{ A}$ $di_F/dt = 100\text{ A}/\mu\text{s}$ $V_{FR} = 1.1 \times V_{Fmax}$, $T_j = 25^\circ\text{C}$			180	ns
V_{FP}	Forward recovery voltage	$I_F = 5\text{ A}$ $di_F/dt = 100\text{ A}/\mu\text{s}$ $V_{FR} = 1.1 \times V_{Fmax}$, $T_j = 25^\circ\text{C}$		4		V

Figure 1. Conduction losses versus average current

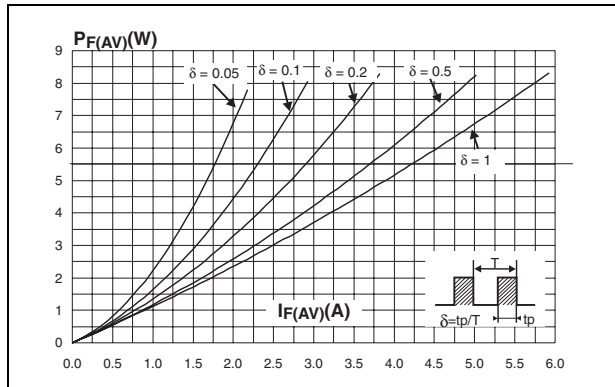

Figure 2. Forward voltage drop versus forward current

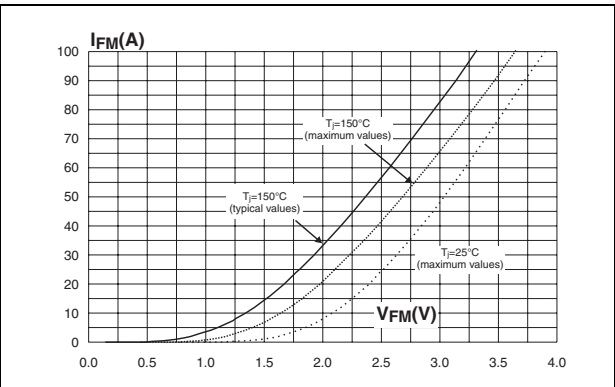

Figure 3. Relative variation of thermal impedance junction to case versus pulse duration (TO-220AC, DPAK)

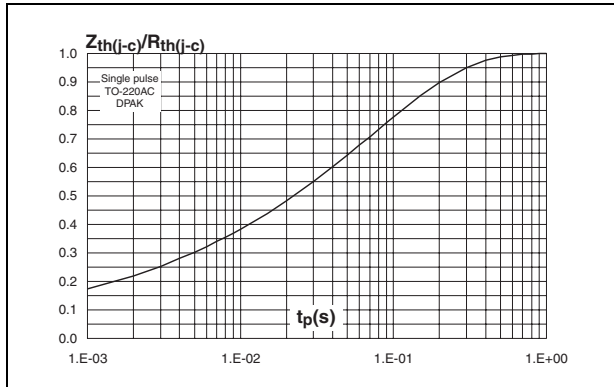

Figure 4. Relative variation of thermal impedance junction to case versus pulse duration (TO-220FPAC)

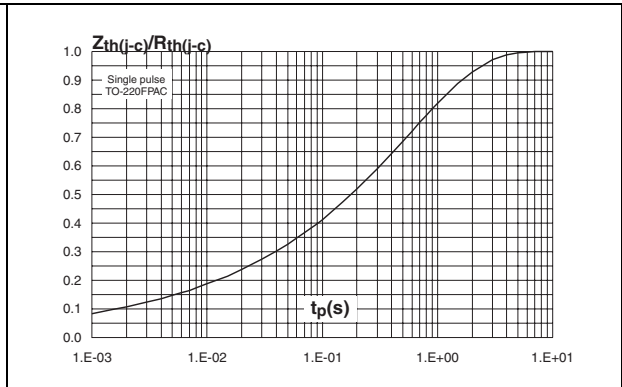

Figure 5. Peak reverse recovery current versus di_F/dt (typical values)

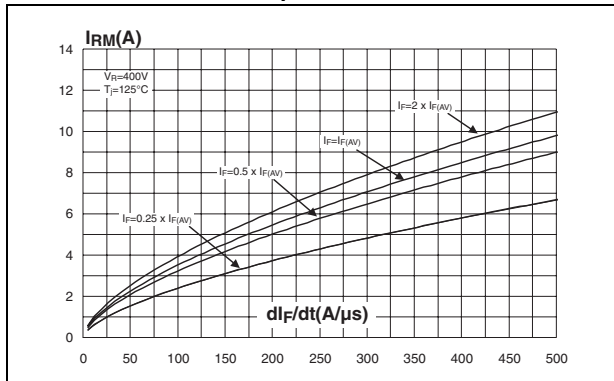

Figure 6. Reverse recovery time versus di_F/dt (typical values)

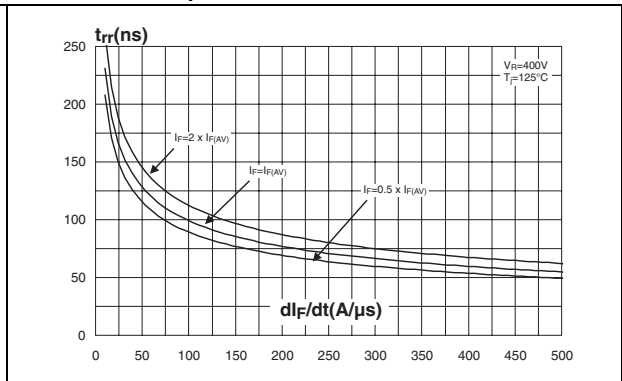

Figure 7. Reverse recovery charges versus di_F/dt (typical values)

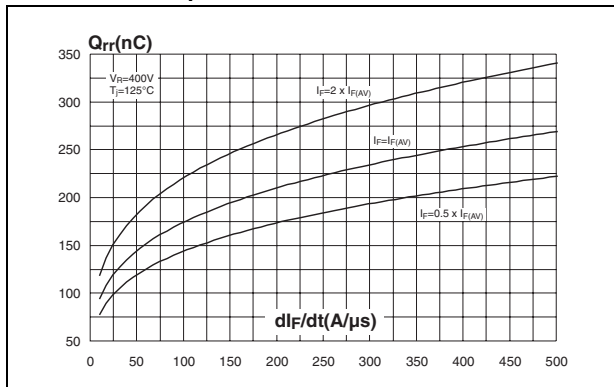

Figure 8. Softness factor versus di_F/dt (typical values)

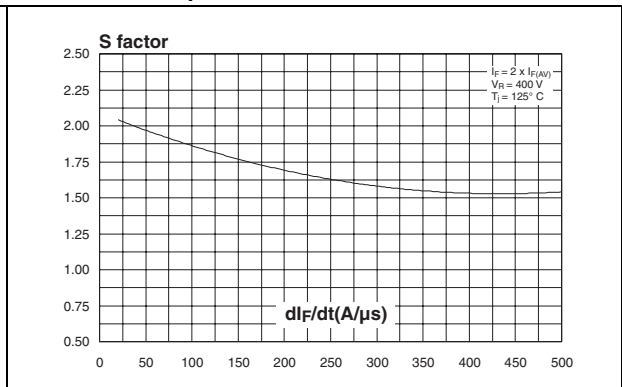

Figure 9. Relative variations of dynamic parameters versus junction temperature

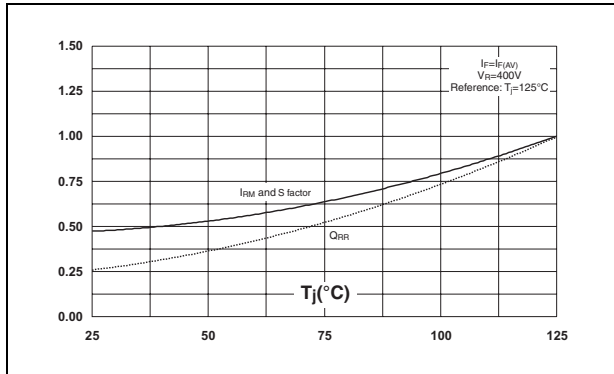

Figure 10. Transient peak forward voltage versus di_F/dt (typical values)

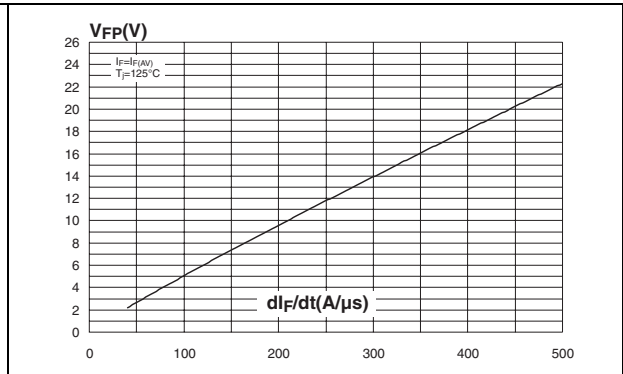

Figure 11. Forward recovery time versus di_F/dt (typical values)

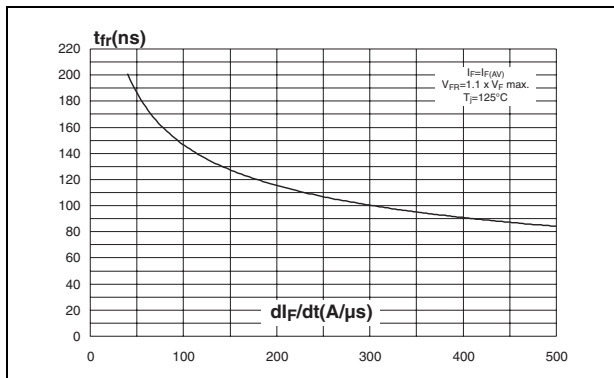

Figure 12. Junction capacitance versus reverse voltage applied (typical values)

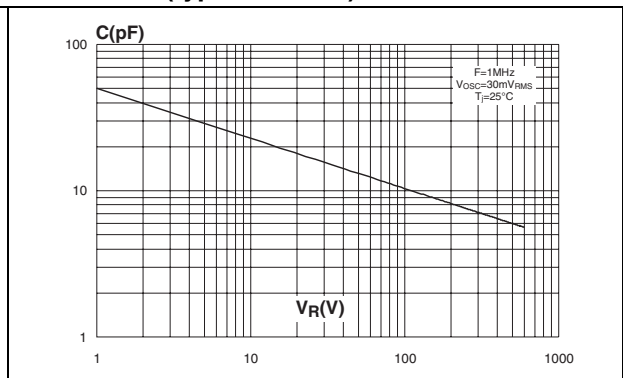
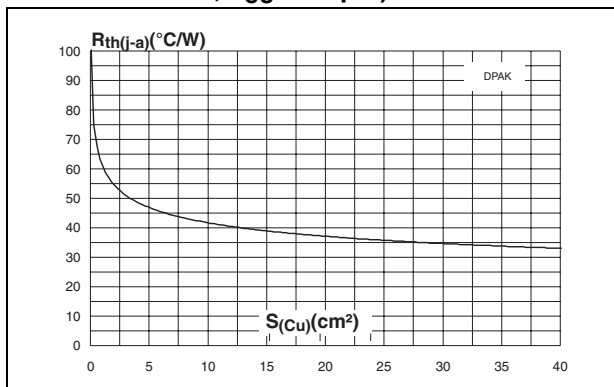

Figure 13. Thermal resistance junction to ambient versus copper surface under tab (printed circuit board FR4, $e_{Cu} = 35 \mu m$)



2 Package mechanical data

Epoxy meets UL94, V0

Cooling method: by conduction (C)

Recommended torque value: 0.80 Nm

Maximum torque value: 1.0 Nm

Table 5. DPAK Dimensions

Ref.	Dimensions			
	Millimeters		Inches	
	Min.	Max	Min.	Max.
A	2.20	2.40	0.086	0.094
A1	0.90	1.10	0.035	0.043
A2	0.03	0.23	0.001	0.009
B	0.64	0.90	0.025	0.035
B2	5.20	5.40	0.204	0.212
C	0.45	0.60	0.017	0.023
C2	0.48	0.60	0.018	0.023
D	6.00	6.20	0.236	0.244
E	6.40	6.60	0.251	0.259
G	4.40	4.60	0.173	0.181
H	9.35	10.10	0.368	0.397
L2	0.80 typ.		0.031 typ.	
L4	0.60	1.00	0.023	0.039
V2	0°	8°	0°	8°

Figure 14. DPAK Footprint dimensions (in mm)

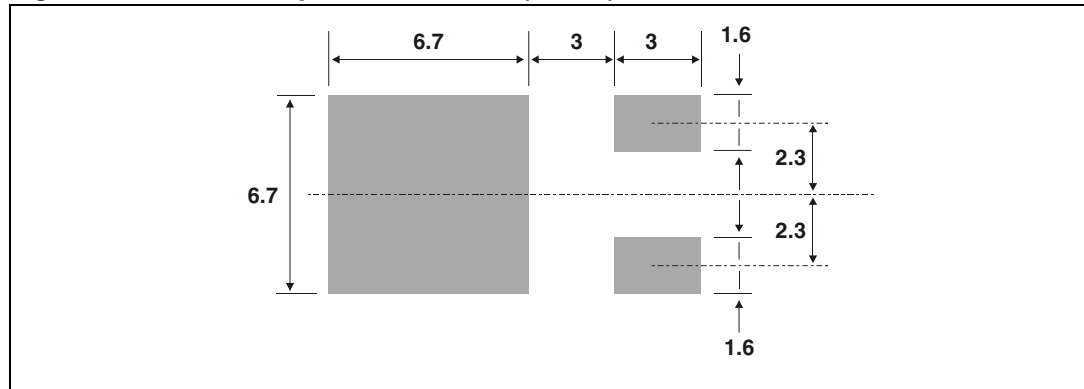

Table 6. TO-220AC Dimensions

The technical drawing shows two views of a TO-220AC package. The front view (left) shows a rectangular body with a central circular feature of diameter $\varnothing I$. Dimensions include H2 (width), L5 (height from top to body), L6 (height of body), L9 (height of lead), L4 (height of lead), F1 (lead thickness), F (lead width), and G (lead length). The side view (right) shows the profile of the package with dimensions A (total height), C (height of top flange), L7 (height of body), D (height of lead), M (lead thickness), and E (lead length).

Ref.	Dimensions			
	Millimeters		Inches	
	Min.	Max.	Min.	Max.
A	4.40	4.60	0.173	0.181
C	1.23	1.32	0.048	0.051
D	2.40	2.72	0.094	0.107
E	0.49	0.70	0.019	0.027
F	0.61	0.88	0.024	0.034
F1	1.14	1.70	0.044	0.066
G	4.95	5.15	0.194	0.202
H2	10.00	10.40	0.393	0.409
L2	16.40 typ.		0.645 typ.	
L4	13.00	14.00	0.511	0.551
L5	2.65	2.95	0.104	0.116
L6	15.25	15.75	0.600	0.620
L7	6.20	6.60	0.244	0.259
L9	3.50	3.93	0.137	0.154
M	2.6 typ.		0.102 typ.	
Diam. I	3.75	3.85	0.147	0.151

Table 7. TO-220FPAC Dimensions

Ref.	Dimensions			
	Millimeters		Inches	
	Min.	Max.	Min.	Max.
A	4.4	4.6	0.173	0.181
B	2.5	2.7	0.098	0.106
D	2.5	2.75	0.098	0.108
E	0.45	0.70	0.018	0.027
F	0.75	1	0.030	0.039
F1	1.15	1.70	0.045	0.067
G	4.95	5.20	0.195	0.205
G1	2.4	2.7	0.094	0.106
H	10	10.4	0.393	0.409
L2	16 Typ.		0.63 Typ.	
L3	28.6	30.6	1.126	1.205
L4	9.8	10.6	0.386	0.417
L5	2.9	3.6	0.114	0.142
L6	15.9	16.4	0.626	0.646
L7	9.00	9.30	0.354	0.366
Dia.	3.00	3.20	0.118	0.126

In order to meet environmental requirements, ST offers these devices in ECOPACK® packages. These packages have a lead-free second level interconnect. The category of second level interconnect is marked on the package and on the inner box label, in compliance with JEDEC Standard JESD97. The maximum ratings related to soldering conditions are also marked on the inner box label. ECOPACK is an ST trademark. ECOPACK specifications are available at: www.st.com.

3 Ordering information

Part Number	Marking	Package	Weight	Base qty	Delivery mode
STTH506B	STTH506B	DPAK	0.3 g	75	Tube
STTH506B-TR	STTH506B	DPAK	0.3 g	2500	Tape and reel
STTH506D	STTH506D	TO-220AC	1.86	50	Tube
STTH506FP	STTH506FP	TO-220FPAC	1.8 g	50	Tube

4 Revision history

Date	Revision	Description of Changes
18-May-2006	1	First issue.

Please Read Carefully:

Information in this document is provided solely in connection with ST products. STMicroelectronics NV and its subsidiaries ("ST") reserve the right to make changes, corrections, modifications or improvements, to this document, and the products and services described herein at any time, without notice.

All ST products are sold pursuant to ST's terms and conditions of sale.

Purchasers are solely responsible for the choice, selection and use of the ST products and services described herein, and ST assumes no liability whatsoever relating to the choice, selection or use of the ST products and services described herein.

No license, express or implied, by estoppel or otherwise, to any intellectual property rights is granted under this document. If any part of this document refers to any third party products or services it shall not be deemed a license grant by ST for the use of such third party products or services, or any intellectual property contained therein or considered as a warranty covering the use in any manner whatsoever of such third party products or services or any intellectual property contained therein.

UNLESS OTHERWISE SET FORTH IN ST'S TERMS AND CONDITIONS OF SALE ST DISCLAIMS ANY EXPRESS OR IMPLIED WARRANTY WITH RESPECT TO THE USE AND/OR SALE OF ST PRODUCTS INCLUDING WITHOUT LIMITATION IMPLIED WARRANTIES OF MERCHANTABILITY, FITNESS FOR A PARTICULAR PURPOSE (AND THEIR EQUIVALENTS UNDER THE LAWS OF ANY JURISDICTION), OR INFRINGEMENT OF ANY PATENT, COPYRIGHT OR OTHER INTELLECTUAL PROPERTY RIGHT.

UNLESS EXPRESSLY APPROVED IN WRITING BY AN AUTHORIZED REPRESENTATIVE OF ST, ST PRODUCTS ARE NOT DESIGNED, AUTHORIZED OR WARRANTED FOR USE IN MILITARY, AIR CRAFT, SPACE, LIFE SAVING, OR LIFE SUSTAINING APPLICATIONS, NOR IN PRODUCTS OR SYSTEMS, WHERE FAILURE OR MALFUNCTION MAY RESULT IN PERSONAL INJURY, DEATH, OR SEVERE PROPERTY OR ENVIRONMENTAL DAMAGE.

Resale of ST products with provisions different from the statements and/or technical features set forth in this document shall immediately void any warranty granted by ST for the ST product or service described herein and shall not create or extend in any manner whatsoever, any liability of ST.

ST and the ST logo are trademarks or registered trademarks of ST in various countries.

Information in this document supersedes and replaces all information previously supplied.

The ST logo is a registered trademark of STMicroelectronics. All other names are the property of their respective owners.

© 2006 STMicroelectronics - All rights reserved

STMicroelectronics group of companies

Australia - Belgium - Brazil - Canada - China - Czech Republic - Finland - France - Germany - Hong Kong - India - Israel - Italy - Japan - Malaysia - Malta - Morocco - Singapore - Spain - Sweden - Switzerland - United Kingdom - United States of America

www.st.com