

## 550MHz low noise current feedback amplifier

### Features

- Bandwidth: 550MHz in unity gain
- Quiescent current: 4.1mA
- Slew rate: 940V/ $\mu$ s
- Input noise: 1.5nV/ $\sqrt{\text{Hz}}$
- Distortion: SFDR=-66dBc (10MHz, 1V<sub>pp</sub>)
- 2.8V<sub>pp</sub> minimum output swing on 100 $\Omega$  load for a 5V supply
- Tested on 5V power supply

### Applications

- Communication & video test equipment
- Medical instrumentation
- ADC drivers

### Description

The TSH350 is a current feedback operational amplifier using a very high-speed complementary technology to provide a bandwidth up to 410MHz while drawing only 4.1mA of quiescent current. With a slew rate of 940V/ $\mu$ s and an output stage optimized for driving a standard 100 $\Omega$  load, this circuit is highly suitable for applications where speed and power-saving are the main requirements.

The TSH350 is a single operator available in the tiny SOT23-5 and SO-8 plastic packages, saving board space as well as providing excellent thermal and dynamic performance.

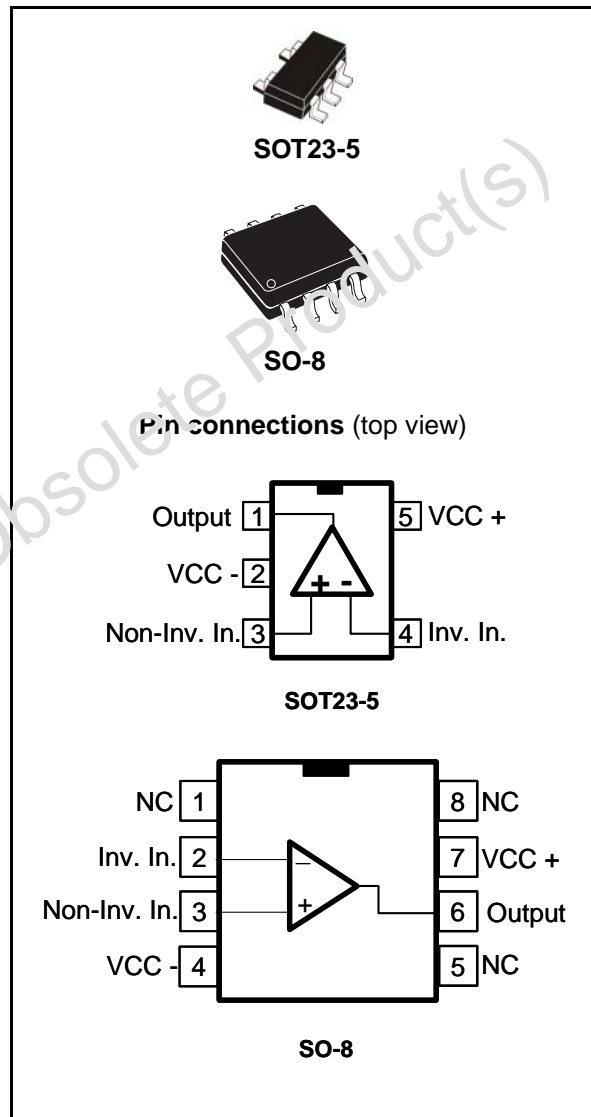

# 1 Absolute maximum ratings

**Table 1. Absolute maximum ratings (AMR)**

Symbol	Parameter	Value	Unit
$V_{CC}$	Supply voltage <sup>(1)</sup>	6	V
$V_{id}$	Differential input voltage <sup>(2)</sup>	+/-0.5	V
$V_{in}$	Input voltage range <sup>(3)</sup>	+/-2.5	V
$T_{stg}$	Storage temperature	-65 to +150	°C
$T_j$	Maximum junction temperature	150	°C
$R_{thja}$	Thermal resistance junction to ambient		
	SOT23-5 SO-8	250 150	°C/W
$R_{thjc}$	Thermal resistance junction to case		
	SOT23-5 SO-8	80 28	°C/W
$P_{max}$	Maximum power dissipation <sup>(4)</sup> (@ $T_{amb}=25^{\circ}C$ ) for $T_j \leq 150^{\circ}C$		
	SOT23-5 SO-8	500 830	mW
ESD	HBM: human body model <sup>(5)</sup> pins 1, 4, 5, 6, 7 and 8 pins 2 and 3	2 0.5	kV
	MM: machine model <sup>(6)</sup> pins 1, 4, 5, 6, 7 and 8 pins 2 and 3	200 60	V
	CDM: charged device model <sup>(7)</sup> pins 1, 4, 5, 6, 7 and 8 pins 2 and 3	1.5 1.5	kV
	Latch-up immunity	200	mA

- All voltage values are measured with respect to the ground pin.
- Differential voltage is the non-inverting input terminal with respect to the inverting input terminal.
- The magnitude of input and output voltage must never exceed  $V_{CC} + 0.3V$ .
- Short-circuits can cause excessive heating. Destructive dissipation can result from short-circuits on all amplifiers.
- Human body model: A 100pF capacitor is charged to the specified voltage, then discharged through a 1.5kΩ resistor between two pins of the device. This is done for all couples of connected pin combinations while the other pins are floating.
- Machine model: A 200pF capacitor is charged to the specified voltage, then discharged directly between two pins of the device with no external series resistor (internal resistor < 5Ω). This is done for all couples of connected pin combinations while the other pins are floating.
- Charged device model: all pins and the package are charged together to the specified voltage and then discharged directly to the ground through only one pin. This is done for all pins.

**Table 2. Operating conditions**

Symbol	Parameter	Value	Unit
$V_{CC}$	Supply voltage <sup>(1)</sup>	4.5 to 5.5	V
$V_{icm}$	Common mode input voltage	$-V_{CC}+1.5V$ to $+V_{CC}-1.5V$	V
$T_{oper}$	Operating free air temperature range	-40 to + 85	°C

1. Tested in full production at 5V ( $\pm 2.5V$ ) supply voltage.

Obsolete Product(s) - Obsolete Product(s)

## 2 Electrical characteristics

**Table 3. Electrical characteristics for  $V_{CC} = \pm 2.5V$ ,  $T_{amb} = 25^{\circ}C$  (unless otherwise specified)**

Symbol	Parameter	Test conditions	Min.	Typ.	Max.	Unit
<b>DC performance</b>						
$V_{io}$	<b>Input offset voltage</b> Offset voltage between both inputs	$T_{amb}$		0.8	4	mV
		$T_{min} < T_{amb} < T_{max}$		1		
$\Delta V_{io}$	$V_{io}$ drift vs. temperature	$T_{min} < T_{amb} < T_{max}$		0.9		$\mu V/^{\circ}C$
$I_{ib+}$	<b>Non inverting input bias current</b> DC current necessary to bias the input +	$T_{amb}$		12	35	$\mu A$
		$T_{min} < T_{amb} < T_{max}$		13		
$I_{ib-}$	<b>Inverting input bias current</b> DC current necessary to bias the input -	$T_{amb}$		1	20	$\mu A$
		$T_{min} < T_{amb} < T_{max}$		2.5		
CMR	Common mode rejection ratio $20 \log (\Delta V_{ic} / \Delta V_{io})$	$\Delta V_{ic} = \pm 1V$		56	60	dB
		$T_{min} < T_{amb} < T_{max}$		58		
SVR	Supply voltage rejection ratio $20 \log (\Delta V_{CC} / \Delta V_{io})$	$\Delta V_{CC} = +3.5V$ to $+5V$		68	81	dB
		$T_{min} < T_{amb} < T_{max}$		78		
PSR	Power supply rejection ratio $20 \log (\Delta V_{CC} / \Delta V_{out})$	$A_V = +1$ , $\Delta V_{CC} = \pm 100mV$ $\Delta f = 1kHz$		51		dB
		$T_{min} < T_{amb} < T_{max}$		48		
$I_{CC}$	<b>Positive supply current</b> DC consumption with no input signal	No load		4.1	4.9	mA
<b>Dynamic performance and output characteristics</b>						
$R_{OL}$	<b>Transimpedance</b> Output voltage/input current gain in open loop of a CFA. For a VFA, the analog of this feature is the open loop gain ( $A_{VD}$ )	$\Delta V_{out} = \pm 1V$ , $R_L = 100\Omega$	170	270		$k\Omega$
		$T_{min} < T_{amb} < T_{max}$		250		$k\Omega$
Bw	<b>-3dB bandwidth</b> Frequency where the gain is 3dB below the DC gain $A_V$ Note: Gain bandwidth product criterion is not applicable for current-feedback-amplifiers	Small signal $V_{out} = 20mV_{pp}$ $A_V = +1$ , $R_L = 100\Omega$ $A_V = +2$ , $R_L = 100\Omega$ $A_V = +10$ , $R_L = 100\Omega$ $A_V = -2$ , $R_L = 100\Omega$	250	550 390 125 370		MHz
		<b>Gain flatness @ 0.1dB</b> Band of frequency where the gain variation does not exceed 0.1dB Small signal $V_{out} = 100mV_p$ $A_V = +1$ , $R_L = 100\Omega$		65		
SR	<b>Slew rate</b> Maximum output speed of sweep in large signal	$V_{out} = 2V_{pp}$ , $A_V = +2$ , $R_L = 100\Omega$		940		V/ $\mu s$
$V_{OH}$	High level output voltage	$R_L = 100\Omega$	1.44	1.56		V
		$T_{min} < T_{amb} < T_{max}$		1.49		

Table 3. Electrical characteristics for  $V_{CC} = \pm 2.5V$ ,  $T_{amb} = 25^{\circ}C$  (unless otherwise specified)

Symbol	Parameter	Test conditions	Min.	Typ.	Max.	Unit
$V_{OL}$	Low level output voltage	$R_L = 100\Omega$		-1.53	-1.44	V
		$T_{min} < T_{amb} < T_{max}$		-1.49		
$I_{out}$	<b><math>I_{sink}</math></b> Short-circuit output current coming in the op-amp (see <a href="#">Figure 9</a> )	Output to GND	135	205		mA
		$T_{min} < T_{amb} < T_{max}$		195		
	<b><math>I_{source}</math></b> Output current coming out from the op-amp (see <a href="#">Figure 10</a> )	Output to GND	-140	-210		
		$T_{min} < T_{amb} < T_{max}$		-185		
<b>Noise and distortion</b>						
eN	<b>Equivalent input noise voltage</b> See <a href="#">Section 5: Noise measurements</a>	$F = 100kHz$		1.5		nV/ $\sqrt{Hz}$
iN	<b>Equivalent input noise current (+)</b> See <a href="#">Section 5: Noise measurements</a>	$F = 100kHz$		20		pA/ $\sqrt{Hz}$
	<b>Equivalent input noise current (-)</b> See <a href="#">Section 5: Noise measurements</a>	$F = 100kHz$		13		pA/ $\sqrt{Hz}$
SFDR	<b>Spurious free dynamic range</b> The highest harmonic of the output spectrum when injecting a filtered sine wave	$A_V = +1$ , $V_{CM} = 1V_{pp}$ $F = 10MHz$ $F = 20MHz$ $F = 50MHz$ $F = 100MHz$		-66 -57 -46 -42		dBc

Table 4. Closed-loop gain and feedback components

$V_{CC}(V)$	Gain	$R_{fb} (\Omega)$	-3dB Bw (MHz)	0.1dB Bw (MHz)
$\pm 2.5$	+10	300	125	22
	-10	300	120	20
	+2	300	390	110
	-2	300	370	70
	+1	820	550	65
	-1	300	350	120

Figure 1. Frequency response, positive gain

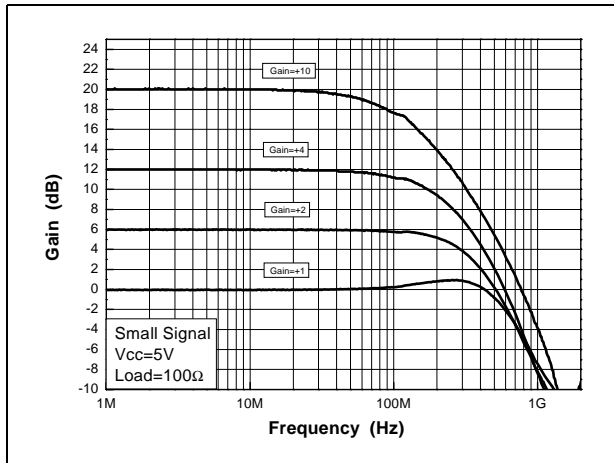

Figure 2. Frequency response, negative gain

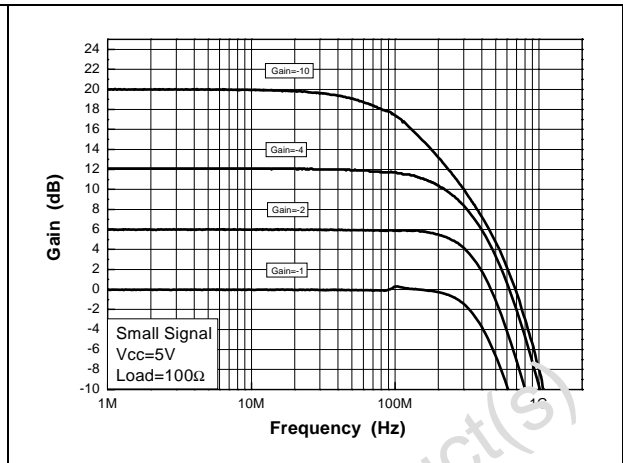

Figure 3. Compensation, gain=+4

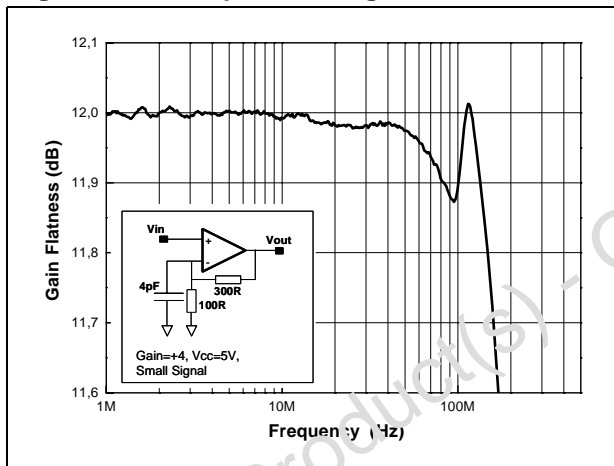

Figure 4. Compensation, gain=+2

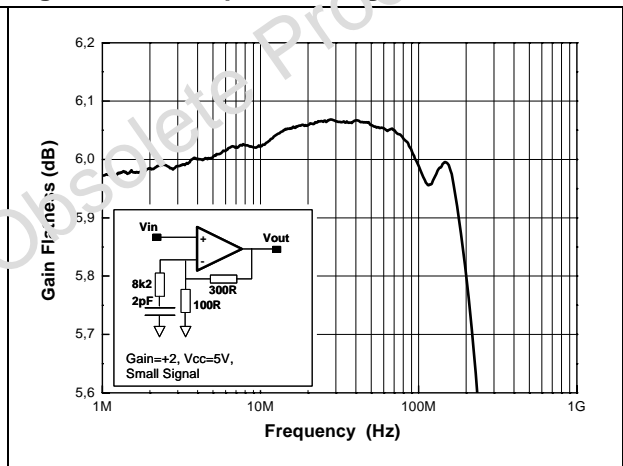

Figure 5. Frequency response vs. capacitor load

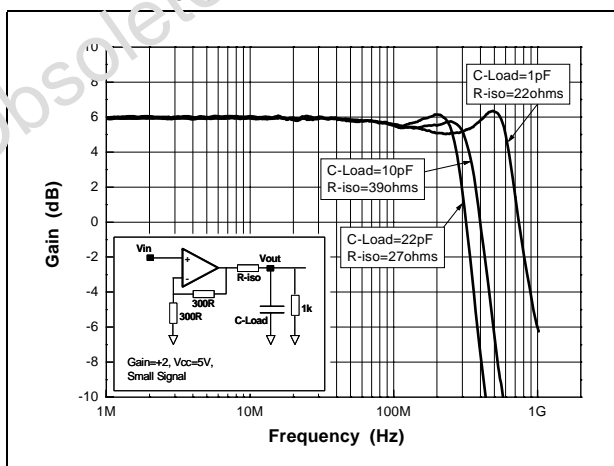

Figure 6. Step response vs. capacitor load

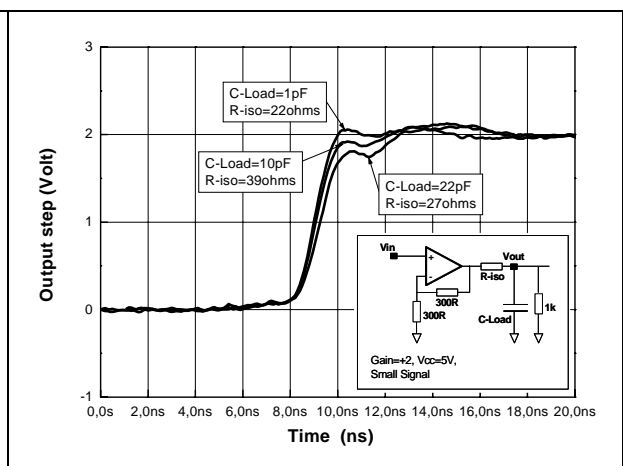

Figure 7. Slew rate

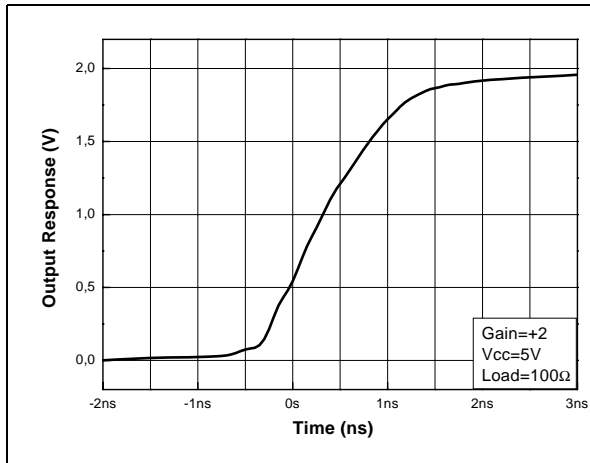

Figure 8. Output amplitude vs. load

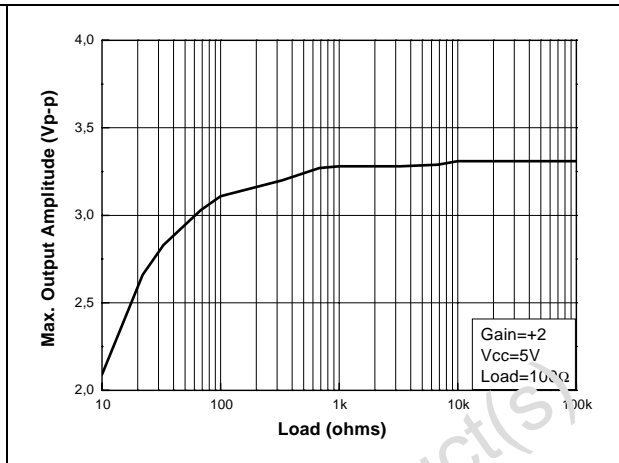

Figure 9.  $I_{sink}$

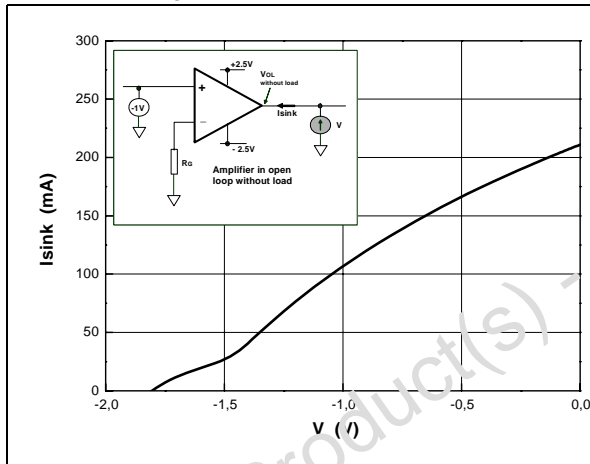

Figure 10.  $I_{source}$

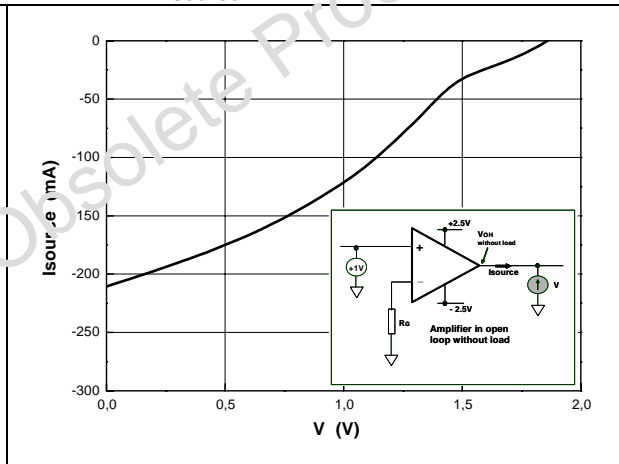

Figure 11. Input current noise vs. frequency

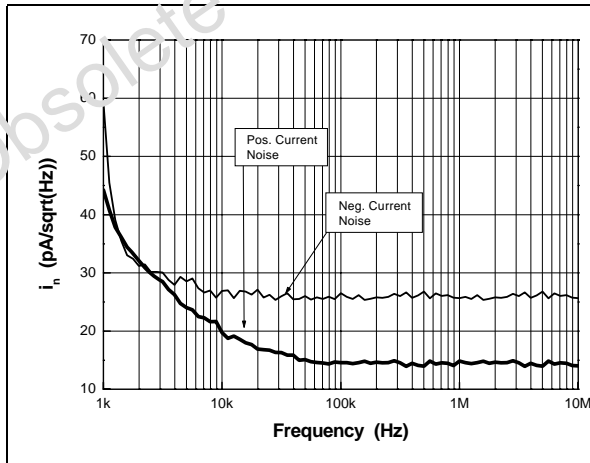

Figure 12. Input voltage noise vs. frequency

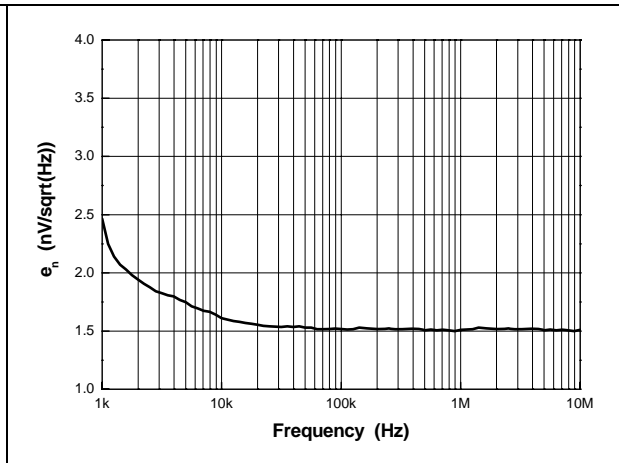

Figure 13. Quiescent current vs.  $V_{CC}$

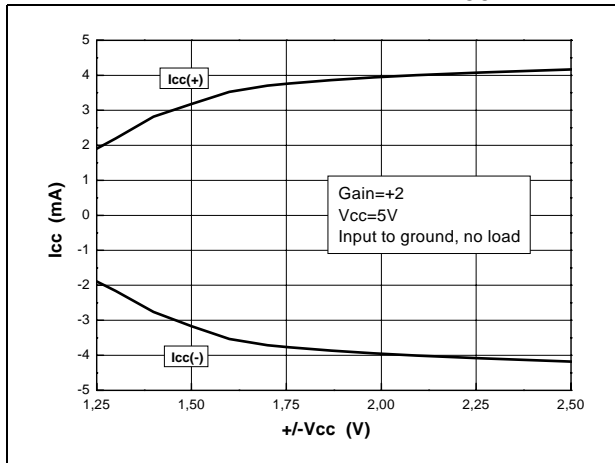

Figure 14. Distortion vs. output amplitude

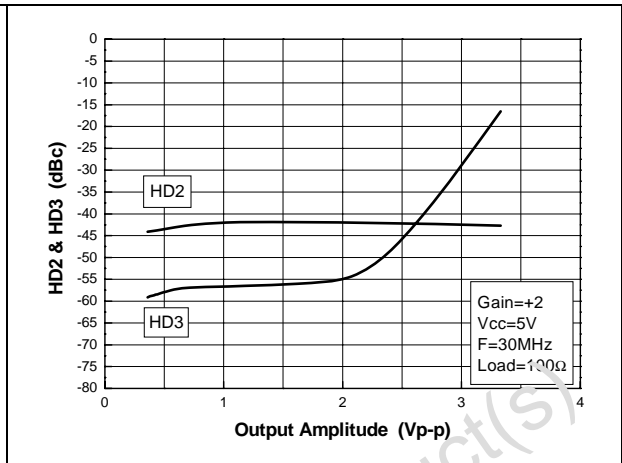

Figure 15. Distortion vs. output amplitude

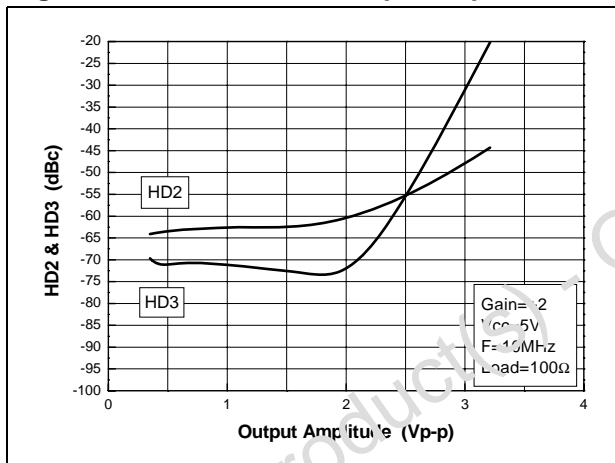

Figure 16. Noise figure

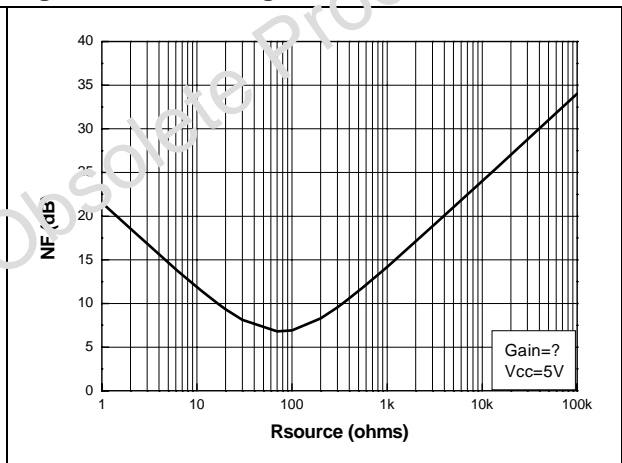

Figure 17. Distortion vs. output amplitude

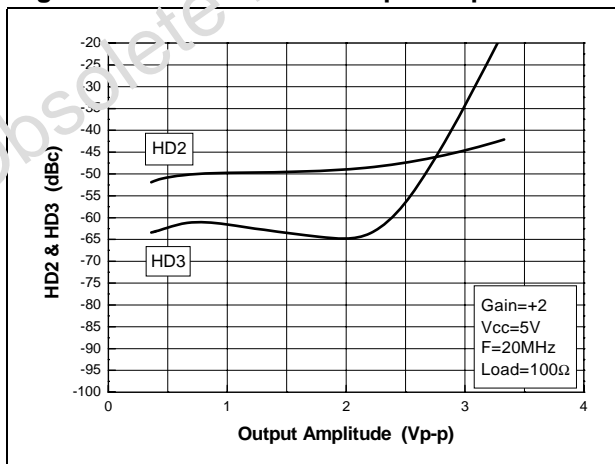

Figure 18. Output amplitude vs. frequency

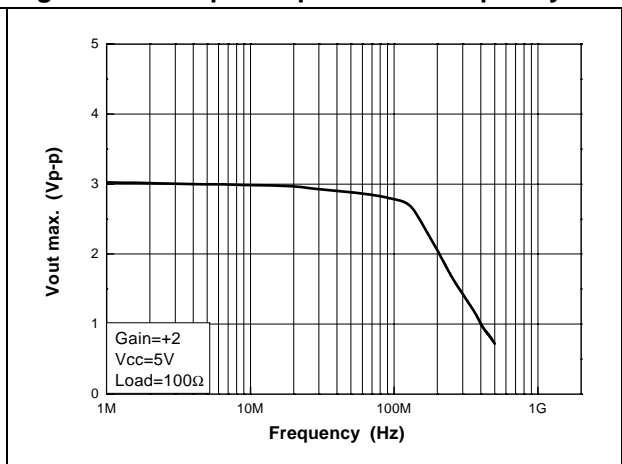

Figure 19. Reverse isolation vs. frequency

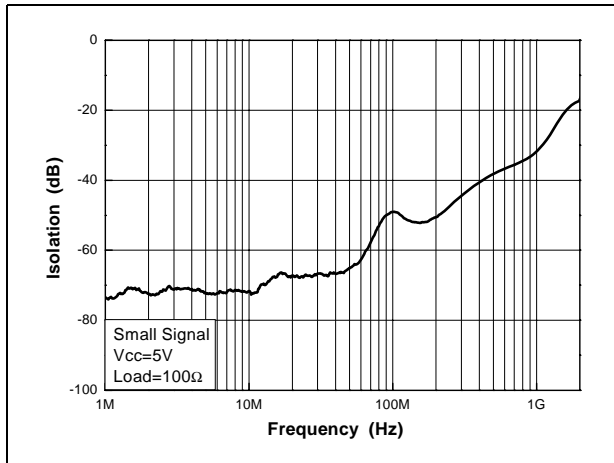

Figure 20. SVR vs. temperature

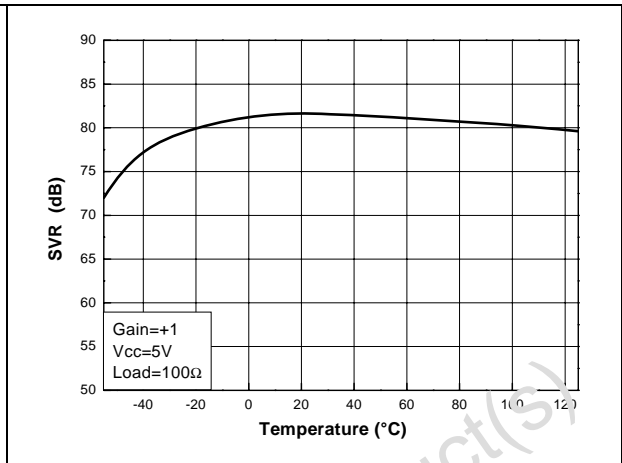

Figure 21. Bandwidth vs. temperature

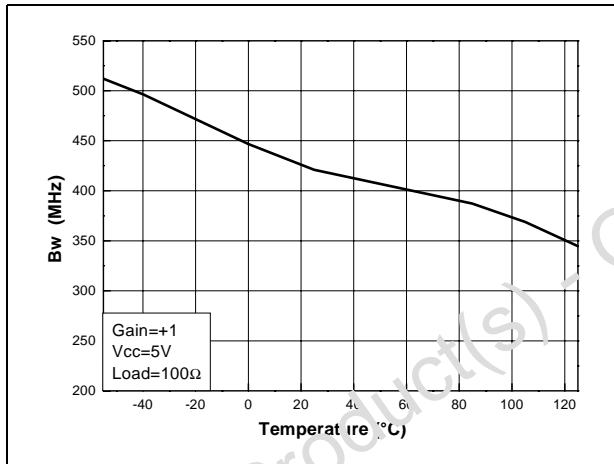

Figure 22.  $R_{OL}$  vs. temperature

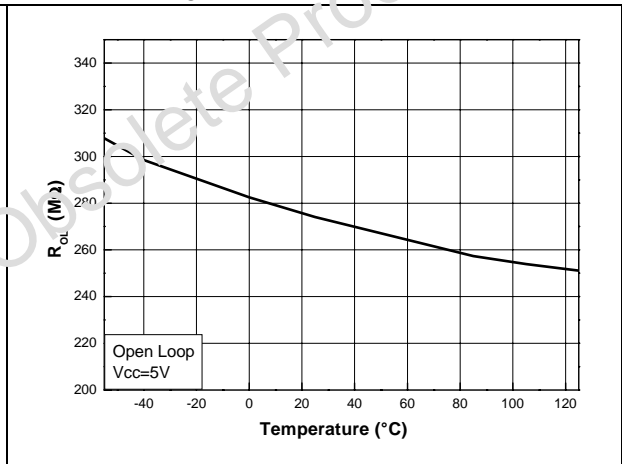

Figure 23. CMR vs. temperature

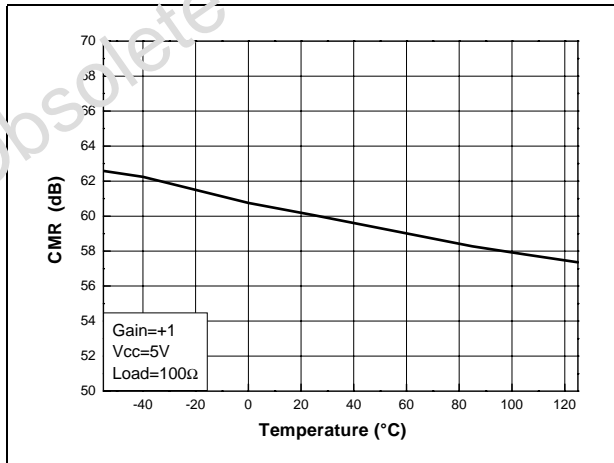

Figure 24.  $I_{bias}$  vs. temperature

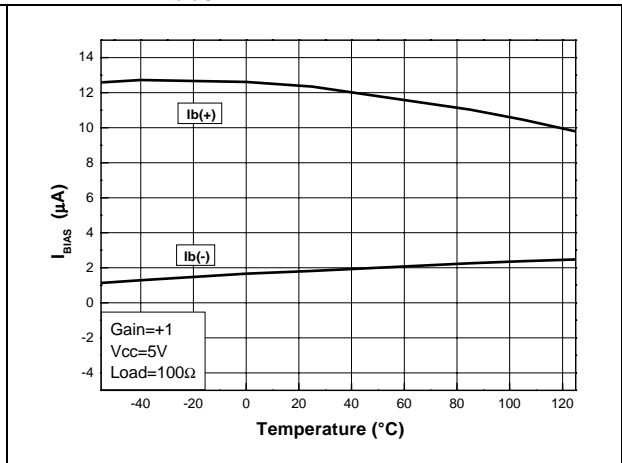

Figure 25.  $V_{io}$  vs. temperature

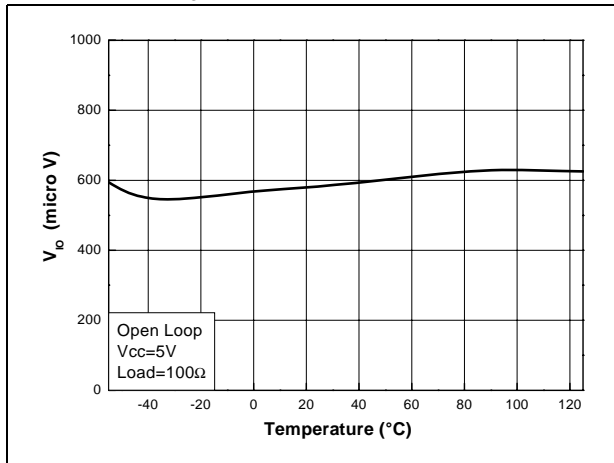

Figure 26.  $I_{CC}$  vs. temperature

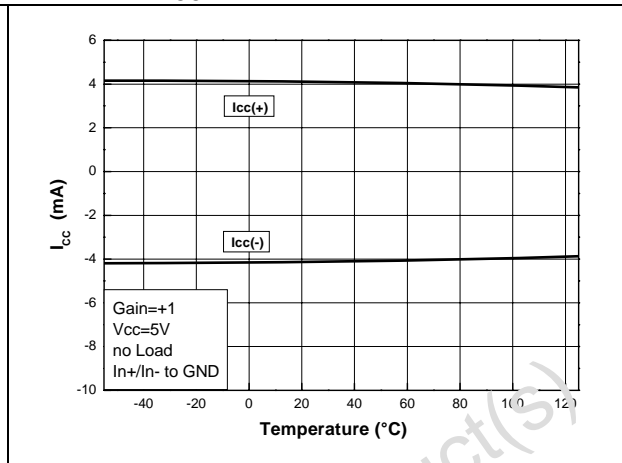

Figure 27.  $V_{OH}$  and  $V_{OL}$  vs. temperature

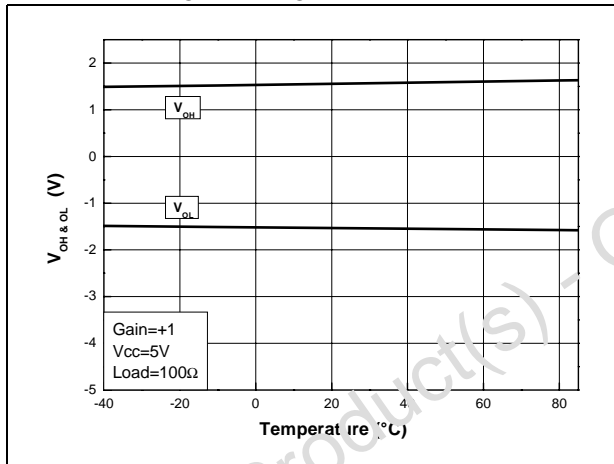
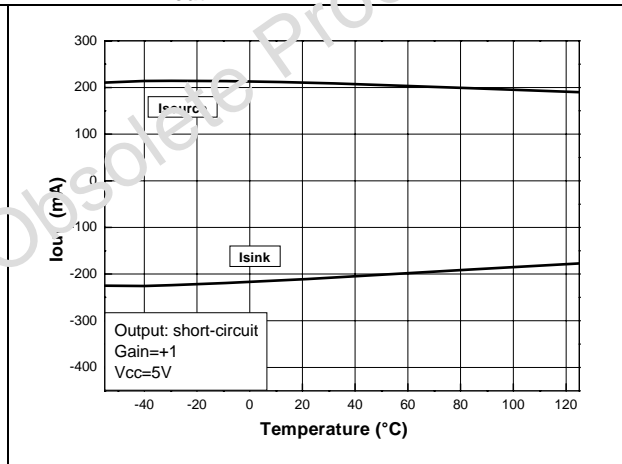

Figure 28.  $I_{out}$  vs. temperature



### 3 Evaluation boards

An evaluation board kit optimized for high-speed operational amplifiers is available (order code: KITHSEVAL/STDL). As well as a CD-ROM containing datasheets, articles, application notes and a user manual, the kit includes the following evaluation boards:

- SOT23\_SINGLE\_HF BOARD  
Board for the evaluation of a single high-speed op-amp in SOT23-5 package.
- SO8\_SINGLE\_HF  
Board for the evaluation of a single high-speed op-amp in SO-8 package.
- SO8\_DUAL\_HF  
Board for the evaluation of a dual high-speed op-amp in SO-8 package.
- SO8\_S\_MULTI  
Board for the evaluation of a single high-speed op-amp in SO-8 package in inverting and non-inverting configuration, dual and single supply.
- SO14\_TRIPLE  
Board for the evaluation of a triple high-speed op-amp in SO-14 package with video application considerations.

**Board material:**

- 2 layers
- FR4 ( $\epsilon_r=4.6$ )
- epoxy 1.6mm
- copper thickness: 35 $\mu$ m

**Figure 29. Evaluation kit for high-speed op-amps**



## 4 Power supply considerations

Correct power supply bypassing is very important for optimizing performance in high-frequency ranges. Bypass capacitors should be placed as close as possible to the IC pins to improve high-frequency bypassing. A capacitor greater than  $1\mu\text{F}$  is necessary to minimize the distortion. For better quality bypassing, a capacitor of  $10\text{nF}$  can be added which should also be placed as close as possible to the IC pins.

Bypass capacitors must be incorporated for both the negative and the positive supply.

*Note:* On the SO8\_SINGLE\_HF board, these capacitors are C6, C7, C8, C9.

**Figure 30. Circuit for power supply bypassing**

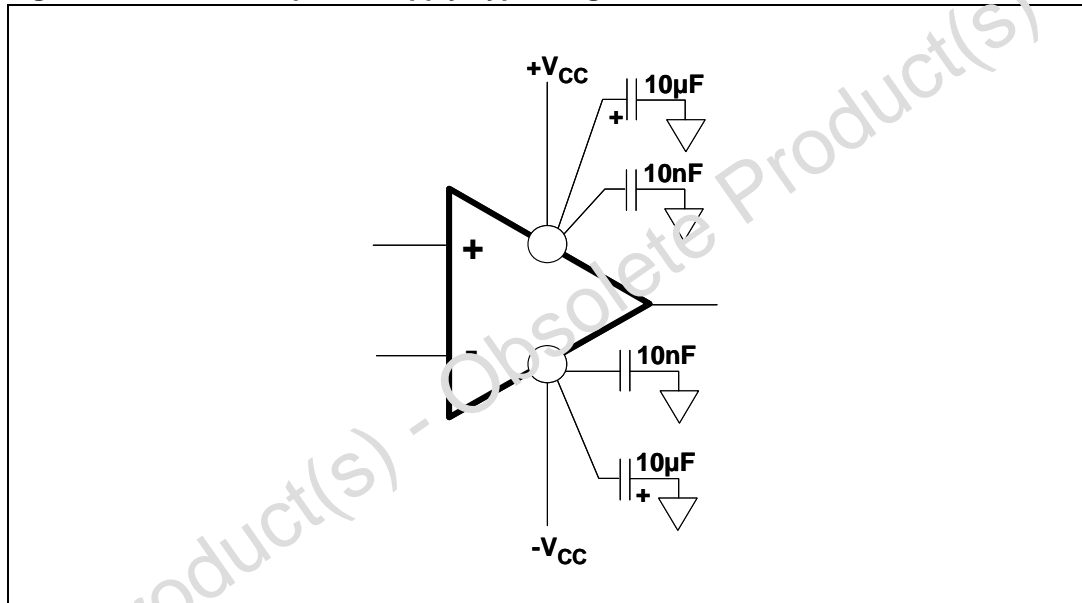

### Single power supply

In the event that a single supply system is used, biasing is necessary to obtain a positive output dynamic range between  $0\text{V}$  and  $+V_{\text{CC}}$  supply rails. Considering the values of  $V_{\text{OH}}$  and  $V_{\text{OL}}$ , the amplifier will provide an output swing from  $+0.9\text{V}$  to  $+4.1\text{V}$  on a  $100\Omega$  load.

The amplifier must be biased with a mid-supply (nominally  $+V_{\text{CC}}/2$ ), in order to maintain the DC component of the signal at this value. Several options are possible to provide this bias supply, such as a virtual ground using an operational amplifier or a two-resistance divider (which is the cheapest solution). A high resistance value is required to limit the current consumption. On the other hand, the current must be high enough to bias the non-inverting input of the amplifier. If we consider this bias current ( $35\mu\text{A}$  maximum) as 1% of the current through the resistance divider, to keep a stable mid-supply, two resistances of  $750\Omega$  can be used.

The input provides a high-pass filter with a break frequency below  $10\text{Hz}$  which is necessary to remove the original  $0\text{V}$  DC component of the input signal, and to fix it at  $+V_{\text{CC}}/2$ .

*Figure 31* illustrates a  $5\text{V}$  single power supply configuration for the SO8\_S\_MULTI evaluation board (see *Evaluation boards* on page 11).

A capacitor  $C_G$  is added in the gain network to ensure a unity gain in low frequency to keep the right DC component at the output.  $C_G$  contributes to a high-pass filter with  $R_{fb}/R_G$  and its value is calculated with a consideration of the cut off frequency of this low-pass filter.

Figure 31. Circuit for +5V single supply (using evaluation board SO8\_S\_MULTI)

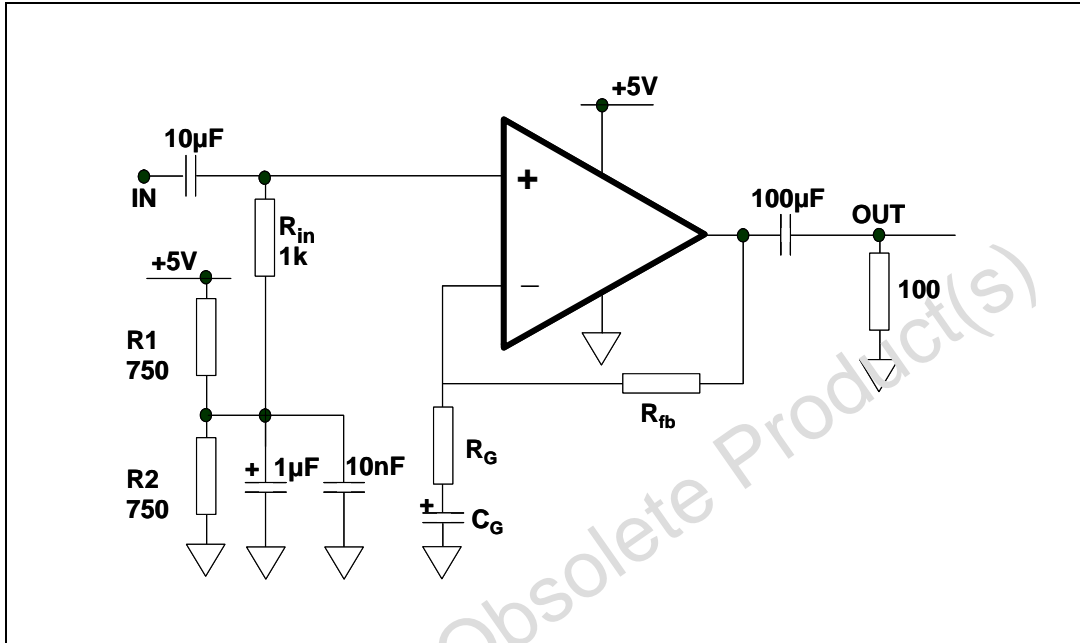

Obsolete Product(s) - Obsolete Product(s)

## 5 Noise measurements

The noise model is shown in [Figure 32](#):

- $eN$  is the input voltage noise of the amplifier
- $iNn$  is the negative input current noise of the amplifier
- $iNp$  is the positive input current noise of the amplifier

**Figure 32. Noise model**

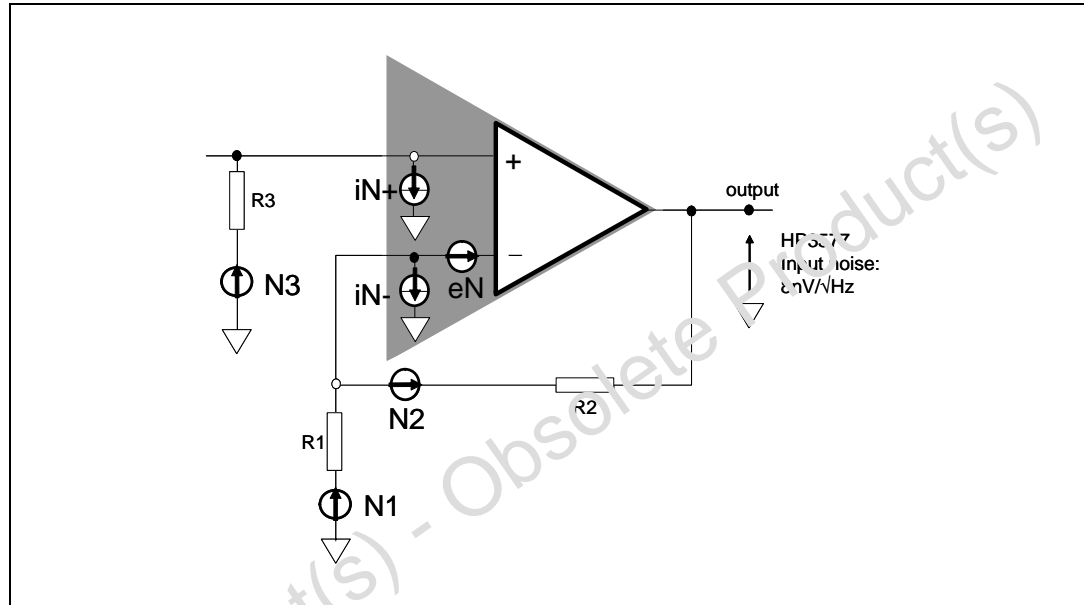

The thermal noise of a resistance R is

$$\sqrt{4kTR\Delta F}$$

where  $\Delta F$  is the specified bandwidth.

On a 1Hz bandwidth the thermal noise is reduced to:

$$\sqrt{4kTR}$$

where  $k$  is the Boltzmann's constant, equal to  $1,374.10^{-23} \text{J/}^\circ\text{K}$ .  $T$  is the temperature ( $^\circ\text{K}$ ).

The output noise  $eNo$  is calculated using the Superposition Theorem. However,  $eNo$  is not the simple sum of all noise sources, but rather the square root of the sum of the square of each noise source, as shown in [Equation 1](#):

**Equation 1**

$$eNo = \sqrt{V1^2 + V2^2 + V3^2 + V4^2 + V5^2 + V6^2}$$

**Equation 2**

$$eNo^2 = eN^2 \times g^2 + iNn^2 \times R2^2 + iNp^2 \times R3^2 \times g^2 + \frac{R2^2}{R1} \times 4kTR1 + 4kTR2 + 1 + \frac{R2^2}{R1} \times 4kTR3$$

The input noise of the instrumentation must be extracted from the measured noise value. The real output noise value of the driver is:

**Equation 3**

$$eNo = \sqrt{(\text{Measured})^2 - (\text{instrumentation})^2}$$

The input noise is called **equivalent input noise** because it is not directly measured but is evaluated from the measurement of the output divided by the closed loop gain ( $eNo/g$ ).

After simplification of the fourth and the fifth term of [Equation 2](#) we obtain:

**Equation 4**

$$eNo^2 = eN^2 \times g^2 + iNn^2 \times R2^2 + iNp^2 \times R3^2 \times g^2 + 4kTR2 + 1 + \frac{R2^2}{R1} \times 4kTR3$$

**Measurement of the input voltage noise  $eN$** 

If we assume a short-circuit on the non-inverting input ( $R3=0$ ), from [Equation 4](#) we can derive:

**Equation 5**

$$eNo = \sqrt{eN^2 \times g^2 + iNn^2 \times R2^2 + g \times 4kTR2}$$

In order to easily extract the value of  $eN$ , the resistance  $R2$  will be chosen to be as low as possible. In the other hand, the gain must be large enough:

$$R3=0, \text{ gain: } g=100$$

**Measurement of the negative input current noise  $iNn$** 

To measure the negative input current noise  $iNn$ , we set  $R3=0$  and use [Equation 5](#). This time, the gain must be lower in order to decrease the thermal noise contribution:

$$R3=0, \text{ gain: } g=10$$

**Measurement of the positive input current noise  $iNp$** 

To extract  $iNp$  from [Equation 3](#), a resistance  $R3$  is connected to the non-inverting input. The value of  $R3$  must be chosen in order to keep its thermal noise contribution as low as possible against the  $iNp$  contribution:

$$R3=100\Omega, \text{ gain: } g=10$$

## 6 Intermodulation distortion product

The non-ideal output of the amplifier can be described by the following series:

$$V_{out} = C_0 + C_1 V_{in} + C_2 V_{in}^2 + \dots + C_n V_{in}^n$$

where the input is  $V_{in} = A \sin \omega t$ ,  $C_0$  is the DC component,  $C_1(V_{in})$  is the fundamental and  $C_n$  is the amplitude of the harmonics of the output signal  $V_{out}$ .

A one-frequency (one-tone) input signal contributes to harmonic distortion. A two-tone input signal contributes to harmonic distortion and to the intermodulation product.

The study of the intermodulation and distortion for a two-tone input signal is the first step in characterizing the driving capability of multi-tone input signals.

In this case:

$$V_{in} = A \sin \omega_1 t + A \sin \omega_2 t$$

then:

$$V_{out} = C_0 + C_1(A \sin \omega_1 t + A \sin \omega_2 t) + C_2(A \sin \omega_1 t + A \sin \omega_2 t)^2 \dots + C_n(A \sin \omega_1 t + A \sin \omega_2 t)^n$$

From this expression, we can extract the distortion terms, and the intermodulation terms from a single sine wave:

- second order intermodulation terms IM2 by the frequencies  $(\omega_1 - \omega_2)$  and  $(\omega_1 + \omega_2)$  with an amplitude of  $C_2 A^2$
- third order intermodulation terms IM3 by the frequencies  $(2\omega_1 - \omega_2)$ ,  $(2\omega_1 + \omega_2)$ ,  $(-\omega_1 + 2\omega_2)$  and  $(\omega_1 - 2\omega_2)$  with an amplitude of  $(3/4)C_3 A^3$

The intermodulation product of the driver is measured by using the driver as a mixer in a summing amplifier configuration (see [Figure 33](#)). In this way, the non-linearity problem of an external mixing device is avoided.

**Figure 33. Inverting summing amplifier (using evaluation board SO8\_S\_MULTI)**

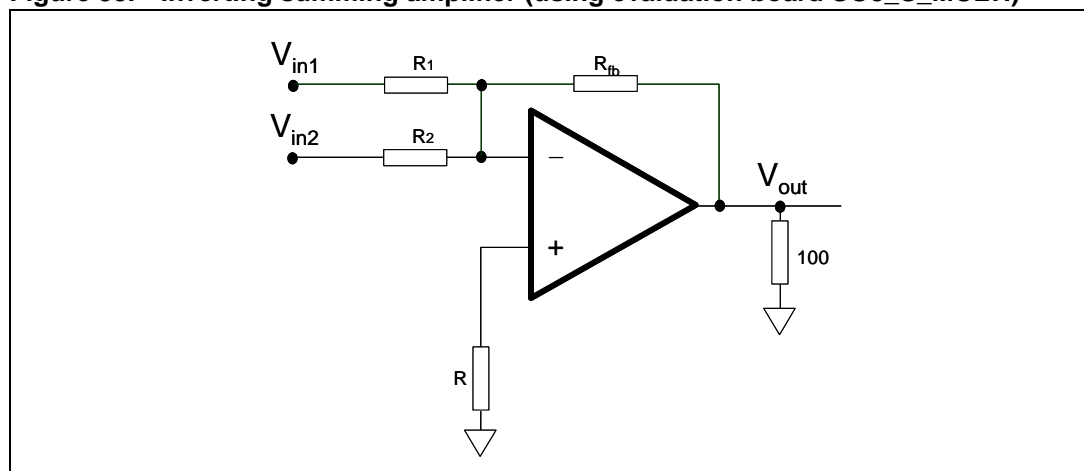

## 7 Inverting amplifier biasing

A resistance is necessary to achieve good input biasing, such as resistance R shown in [Figure 34](#).

The magnitude of this resistance is calculated by assuming the negative and positive input bias current. The aim is to compensate for the offset bias current, which could affect the input offset voltage and the output DC component. Assuming  $I_{ib-}$ ,  $I_{ib+}$ ,  $R_{in}$ ,  $R_{fb}$  and a zero volt output, the resistance R is:

$$R = \frac{R_{in} \times R_{fb}}{R_{in} + R_{fb}}$$

**Figure 34. Compensation of the input bias current**

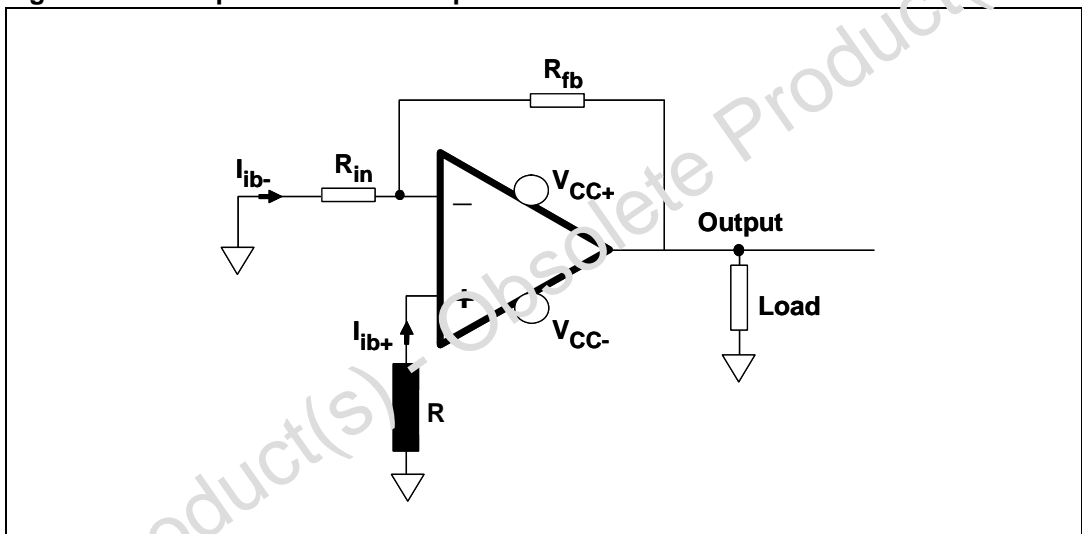

## 8 Active filtering

Figure 35. Low-pass active filtering, Sallen-Key

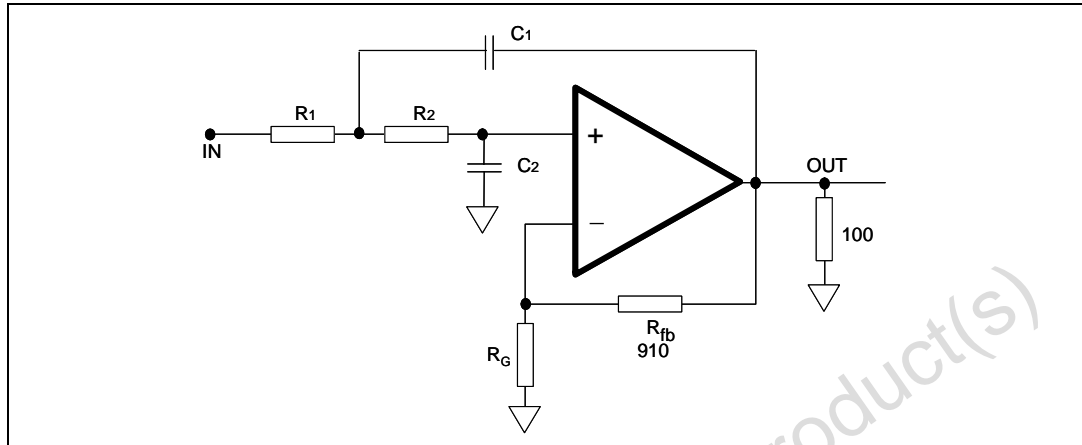

From the resistors  $R_{fb}$  and  $R_G$  we can directly calculate the gain of the filter in a classic non-inverting amplification configuration:

$$A_V = g = 1 + \frac{R_{fb}}{R_g}$$

We assume the following expression as the response of the system:

$$T_{j\omega} = \frac{V_{out_{j\omega}}}{V_{in_{j\omega}}} = \frac{g}{1 + 2\zeta \frac{j\omega}{\omega_c} + \frac{(j\omega)^2}{\omega_c^2}}$$

The cut-off frequency is not gain-dependent and so becomes:

$$\omega_c = \frac{1}{\sqrt{R_1 R_2 C_1 C_2}}$$

The damping factor is calculated by the following expression:

$$\zeta = \frac{1}{2} \omega_c (C_1 R_1 + C_1 R_2 + C_2 R_1 - C_1 R_1 g)$$

The higher the gain, the more sensitive the damping factor is. When the gain is higher than 1, it is preferable to use some very stable resistor and capacitor values. In the case of  $R_1=R_2=R$ :

$$\zeta = \frac{2C_2 - C_1 \frac{R_{fb}}{R_g}}{2\sqrt{C_1 C_2}}$$

Due to a limited selection of values of capacitors in comparison with resistors, we can set  $C_1=C_2=C$ , so that:

$$\zeta = \frac{2R_2 - R_1 \frac{R_{fb}}{R_g}}{2\sqrt{R_1 R_2}}$$

## 9 Package information

Figure 36. SOT23-5 package mechanical data

Ref.	Dimensions					
	Millimeters			Mils		
	Min.	Typ.	Max.	Min.	Typ.	Max.
A	0.90		1.45	35.4		57.1
A1	0.00		0.15	0.00		5.9
A2	0.90		1.30	35.4		51.2
b	0.35		0.50	13.7		19.7
C	0.09		0.20	3.5		7.8
D	2.80		3.00	110.2		118.1
E	2.60		3.00	102.6		118.1
E1	1.50		1.75	59.0		68.8
e		0.95			37.4	
e1		1.9			74.8	
L	0.35		0.55	13.7		21.6

Figure 37. SO-8 package mechanical data

Ref.	Dimensions					
	Millimeters			Inches		
	Min.	Typ.	Max.	Min.	Typ.	Max.
A			1.75			0.069
A1	0.10		0.25	0.004		0.010
A2	1.25			0.049		
b	0.28		0.48	0.011		0.019
c	0.17		0.23	0.007		0.010
D	4.80	4.90	5.00	0.189	0.193	0.197
H	5.80	6.00	6.20	0.228	0.236	0.244
E1	3.80	3.90	4.00	0.150	0.154	0.157
e		1.27			0.050	
h	0.25		0.50	0.010		0.020
L	0.40		1.27	0.016		0.050
k	1°		8°	1°		8°
ccc			0.10			0.004

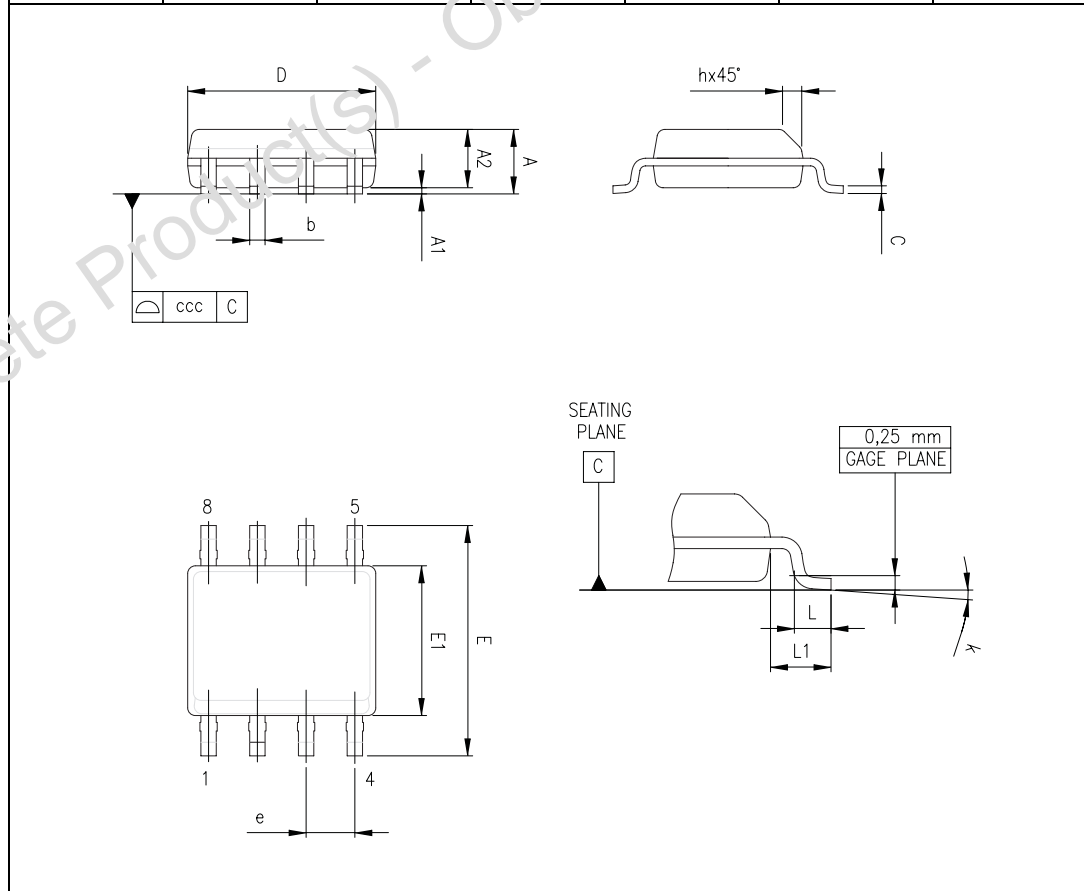

## 10 Ordering information

Table 5. Order codes

Part number	Temperature range	Package	Packing	Marking
TSH350ILT	-40°C to +85°C	SOT23-5	Tape & reel	K305
TSH350ID		SO-8	Tube	TSH350I
TSH350IDT		SO-8	Tape & reel	TSH350I

## 11 Revision history

Date	Revision	Change
1-Oct-2004	1	First release corresponding to Preliminary Data version of datasheet.
10-Dec-2004	2	Release of mature product datasheet.
21-Jun-2005	3	In <a href="#">Table 1</a> on page 2, $R_{th(jc)}$ thermal resistance junction to ambient replaced by thermal resistance junction to case.
8-Jun-2007	4	Format update.

**Please Read Carefully:**

Information in this document is provided solely in connection with ST products. STMicroelectronics NV and its subsidiaries ("ST") reserve the right to make changes, corrections, modifications or improvements, to this document, and the products and services described herein at any time, without notice.

All ST products are sold pursuant to ST's terms and conditions of sale.

Purchasers are solely responsible for the choice, selection and use of the ST products and services described herein, and ST assumes no liability whatsoever relating to the choice, selection or use of the ST products and services described herein.

No license, express or implied, by estoppel or otherwise, to any intellectual property rights is granted under this document. If any part of this document refers to any third party products or services it shall not be deemed a license grant by ST for the use of such third party products or services, or any intellectual property contained therein or considered as a warranty covering the use in any manner whatsoever of such third party products or services or any intellectual property contained therein.

**UNLESS OTHERWISE SET FORTH IN ST'S TERMS AND CONDITIONS OF SALE ST DISCLAIMS ANY EXPRESS OR IMPLIED WARRANTY WITH RESPECT TO THE USE AND/OR SALE OF ST PRODUCTS INCLUDING WITHOUT LIMITATION IMPLIED WARRANTIES OF MERCHANTABILITY, FITNESS FOR A PARTICULAR PURPOSE (AND THEIR EQUIVALENTS UNDER THE LAWS OF ANY JURISDICTION), OR INFRINGEMENT OF ANY PATENT, COPYRIGHT OR OTHER INTELLECTUAL PROPERTY RIGHT.**

**UNLESS EXPRESSLY APPROVED IN WRITING BY AN AUTHORIZED ST REPRESENTATIVE, ST PRODUCTS ARE NOT RECOMMENDED, AUTHORIZED OR WARRANTED FOR USE IN MILITARY, AIR CRAFT, SPACE, LIFE SAVING, OR LIFE SUSTAINING APPLICATIONS, NOR IN PRODUCTION OR SYSTEMS WHERE FAILURE OR MALFUNCTION MAY RESULT IN PERSONAL INJURY, DEATH, OR SEVERE PROPERTY OR ENVIRONMENTAL DAMAGE. ST PRODUCTS WHICH ARE NOT SPECIFIED AS "AUTOMOTIVE GRADE" MAY ONLY BE USED IN AUTOMOTIVE APPLICATIONS AT USER'S OWN RISK.**

Resale of ST products with provisions different from the statements and/or technical features set forth in this document shall immediately void any warranty granted by ST for the ST product or service described herein and shall not create or extend in any manner whatsoever, any liability of ST.

ST and the ST logo are trademarks or registered trademarks of ST in various countries.

Information in this document supersedes and replaces all information previously supplied.

The ST logo is a registered trademark of STMicroelectronics. All other names are the property of their respective owners.

© 2007 STMicroelectronics - All rights reserved

STMicroelectronics group of companies

Australia - Belgium - Brazil - Canada - China - Czech Republic - Finland - France - Germany - Hong Kong - India - Israel - Italy - Japan - Malaysia - Malta - Morocco - Singapore - Spain - Sweden - Switzerland - United Kingdom - United States of America

[www.st.com](http://www.st.com)