

# SMD Power Inductor CD105



Halogen Free



## Description

- Ferrite core construction.
- Magnetically unshielded.
- L × W × H: 10.4 × 9.4 × 5.8mm Max.
- Product weight: 1.3 g(Ref.)
- Moisture Sensitivity Level: 1
- RoHS compliance.
- Halogen Free available.

## Environmental Data

- Operating temperature range: -40°C ~ +100°C (including coil's self temperature rise)
- Storage temperature range: -40°C ~ +100°C
- Solder reflow temperature: 260 °C peak.

## Packaging

- Carrier tape and reel packaging.
- 12.9" diameter reel
- 500pcs per reel

## Applications

- Ideally used in PDA, MP3, DSC/DVC, HDD, Portable DVD, etc as DC-DC converter inductors.

## Dimension - [mm]

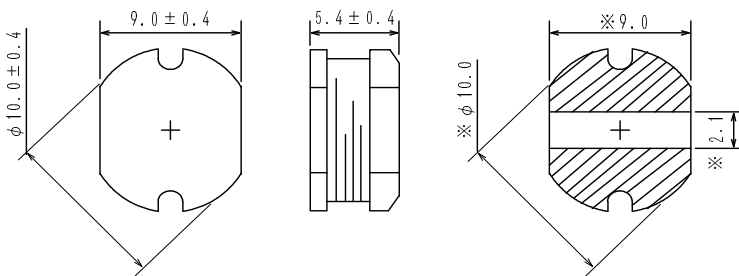

## Land pattern and Schematics - [mm]

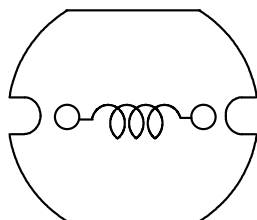
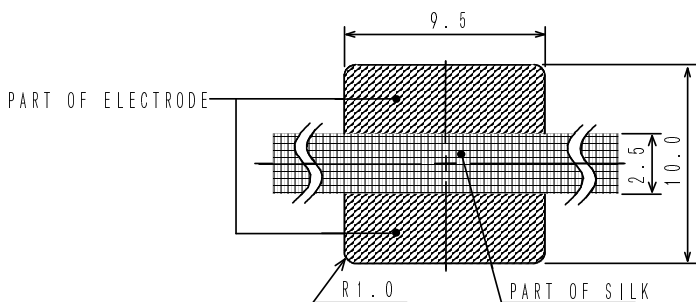

# SMD Power Inductor CD105



## Electrical Characteristics

Part Name	Inductance ( $\mu\text{H}$ ) [Within] ※1	D.C.R. ( $\Omega$ ) [MAX.] (at 20°C)	Rated Current (A) ※2
CD105NP-100MC	10 ± 20%	0.06	2.60
CD105NP-120MC	12 ± 20%	0.07	2.45
CD105NP-150MC	15 ± 20%	0.08	2.27
CD105NP-180MC	18 ± 20%	0.09	2.15
CD105NP-220MC	22 ± 20%	0.10	1.95
CD105NP-270MC	27 ± 20%	0.11	1.76
CD105NP-330MC	33 ± 20%	0.12	1.50
CD105NP-390MC	39 ± 20%	0.14	1.37
CD105NP-470KC	47 ± 10%	0.17	1.28
CD105NP-560KC	56 ± 10%	0.19	1.17
CD105NP-680KC	68 ± 10%	0.22	1.11
CD105NP-820KC	82 ± 10%	0.25	1.00
CD105NP-101KC	100 ± 10%	0.35	0.97
CD105NP-121KC	120 ± 10%	0.40	0.89
CD105NP-151KC	150 ± 10%	0.47	0.78
CD105NP-181KC	180 ± 10%	0.63	0.72
CD105NP-221KC	220 ± 10%	0.73	0.66
CD105NP-271KC	270 ± 10%	0.97	0.57
CD105NP-331KC	330 ± 10%	1.15	0.52
CD105NP-391KC	390 ± 10%	1.30	0.48
CD105NP-471KC	470 ± 10%	1.48	0.42
CD105NP-561KC	560 ± 10%	1.90	0.33
CD105NP-681KC	680 ± 10%	2.25	0.28
CD105NP-821KC	820 ± 10%	2.55	0.24

※1: Inductance measuring frequency: 10  $\mu\text{H}$  ~ 82  $\mu\text{H}$  ; at 2.52MHz.  
100  $\mu\text{H}$  ~ 820  $\mu\text{H}$  ; at 1kHz.

※2: Rated current: The DC current at which the inductance decreases to 90 % of its initial value or when  $\Delta t = 40^\circ\text{C}$ , whichever is lower ( $T_a = 20^\circ\text{C}$ ).

# SMD Power Inductor CD105



## Saturation Current & Temperature Rise Graph

— L (25°C) — L (105°C) —  $\Delta T$

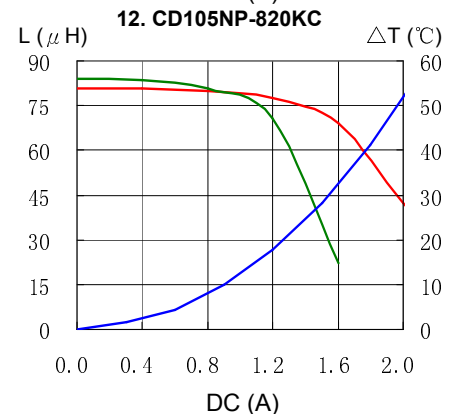
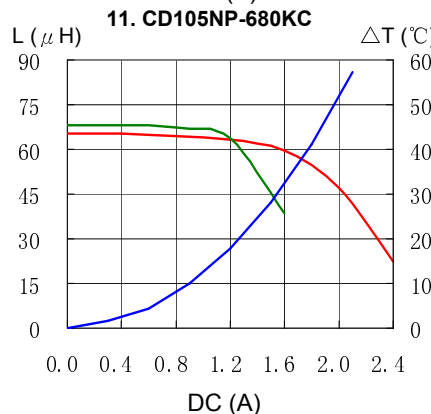
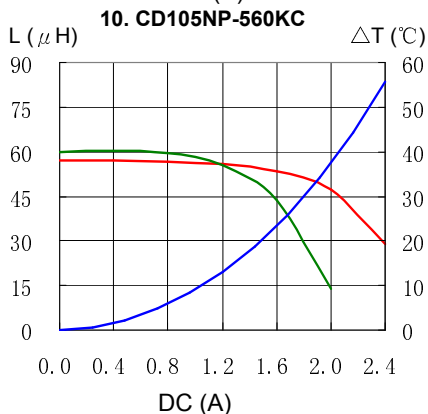
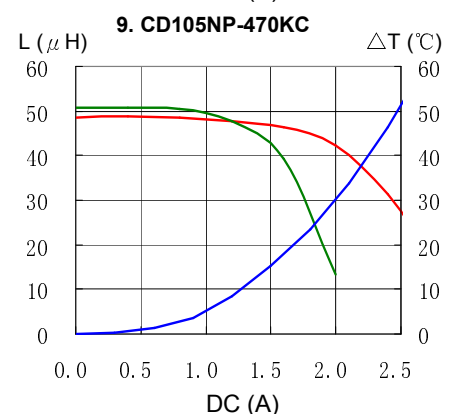
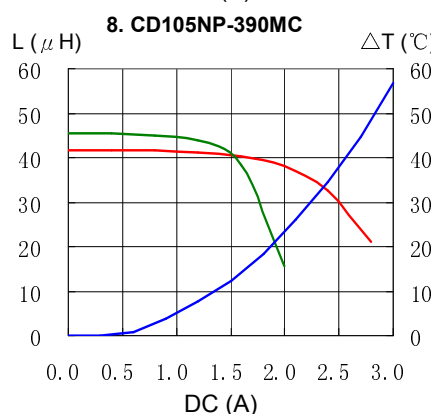
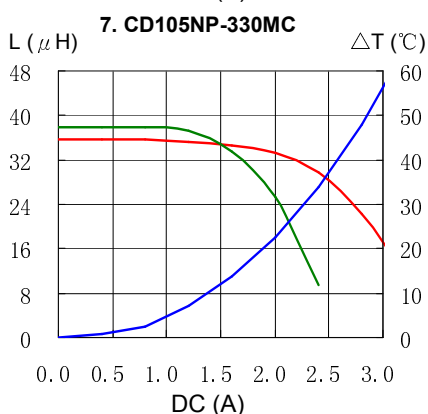
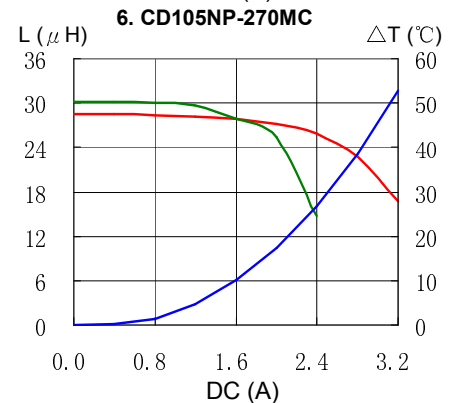
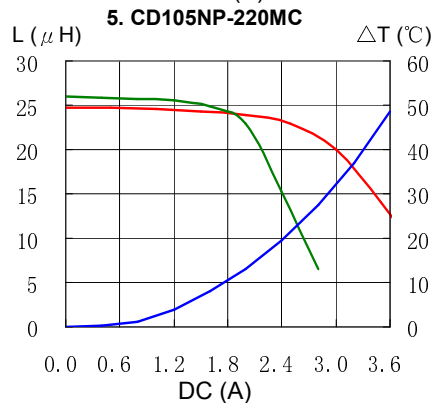
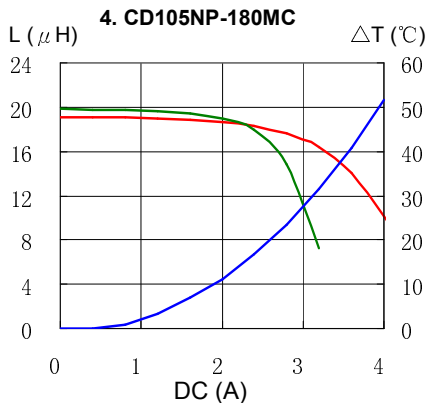
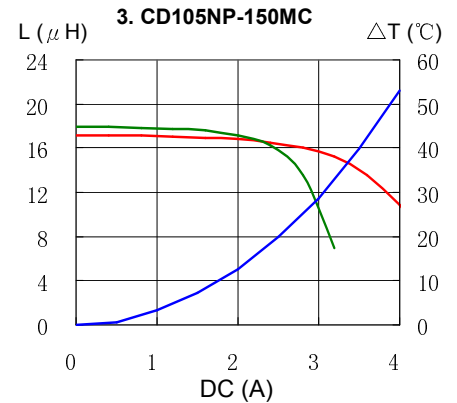
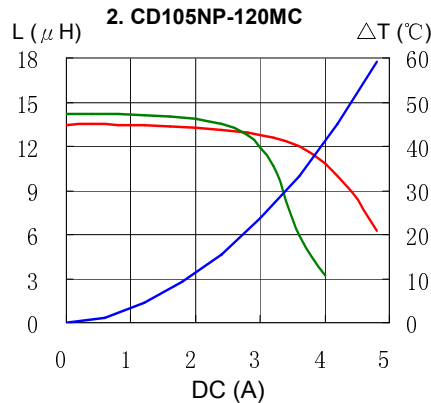
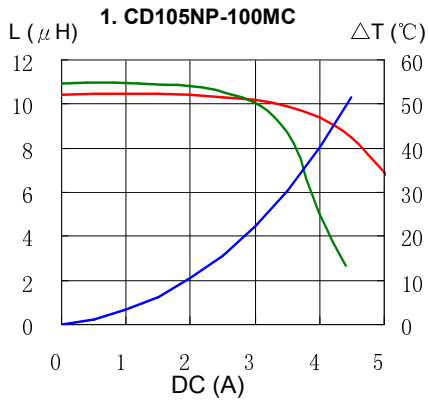

# SMD Power Inductor CD105

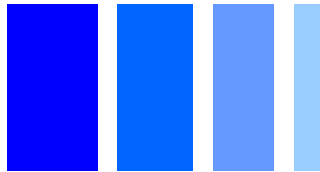

## Saturation Current & Temperature Rise Graph

— L (25°C) — L (105°C) —  $\Delta T$

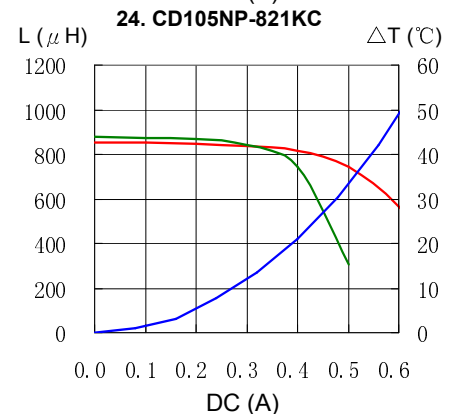
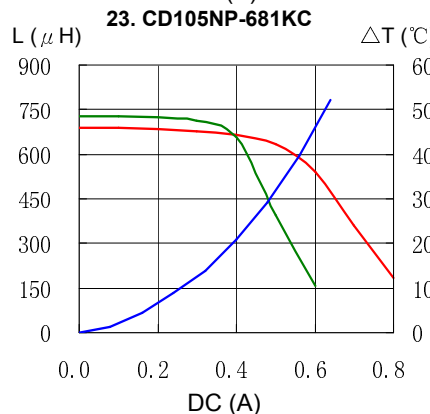
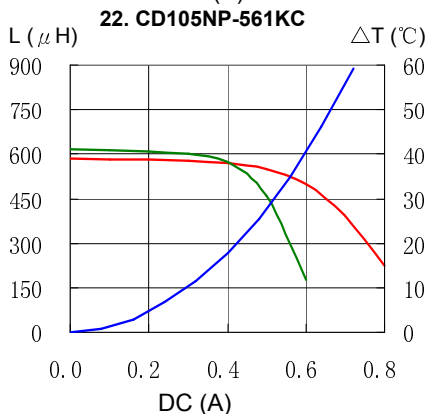
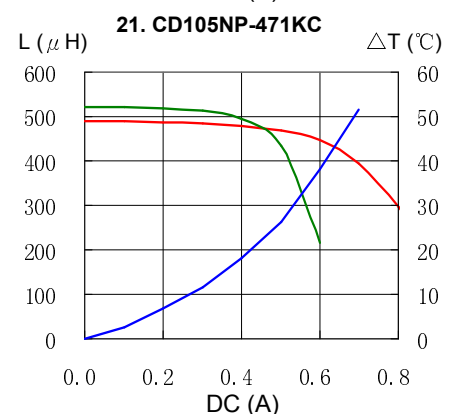
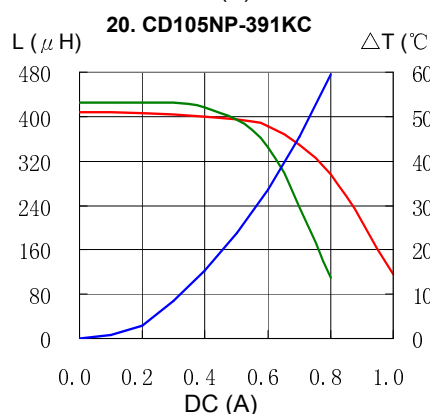
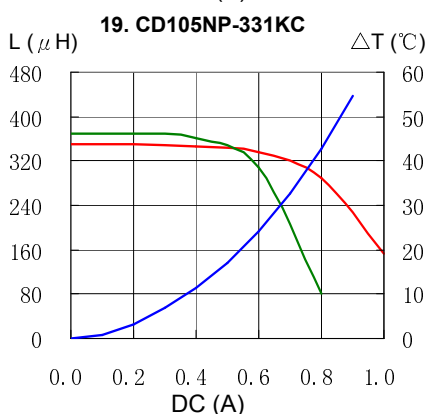
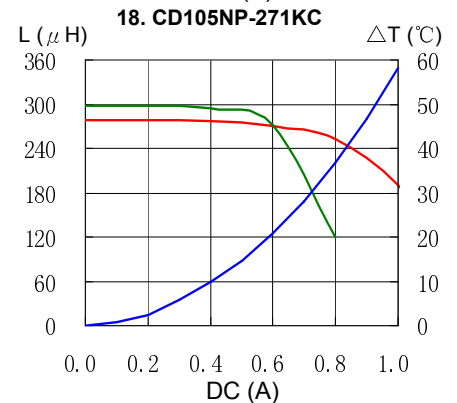
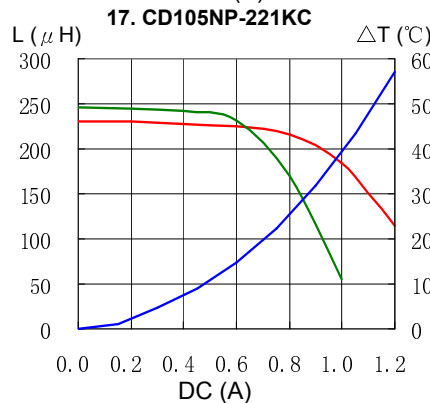
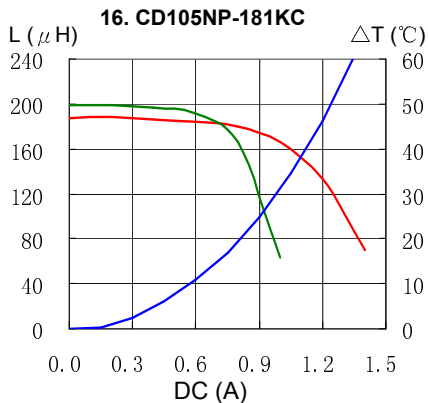
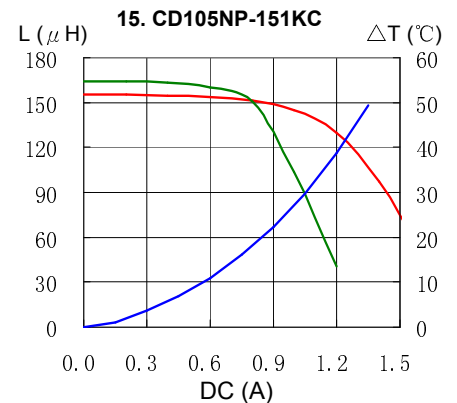
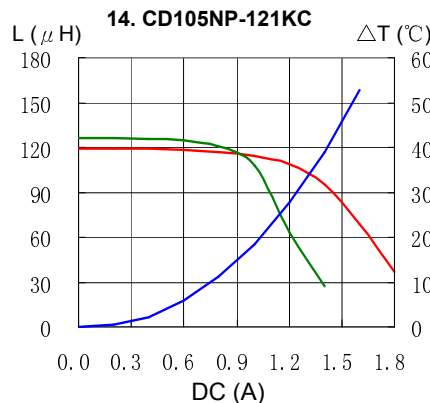
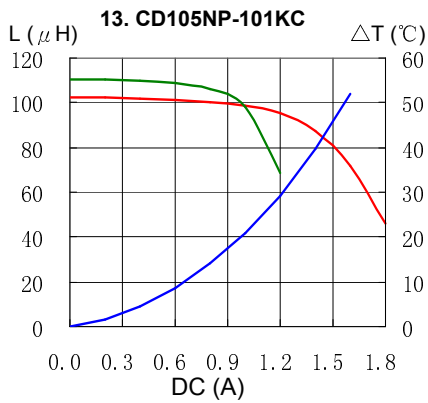

# SMD Power Inductor CD105



## Solder Reflow Condition

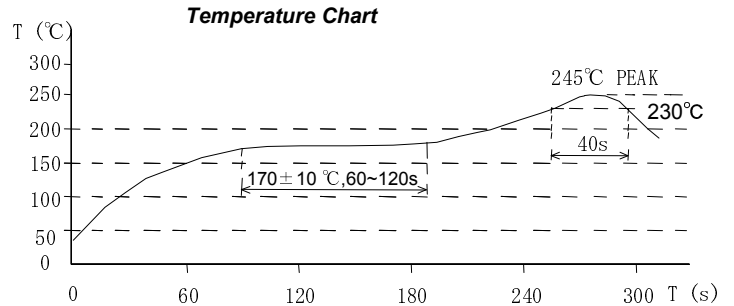
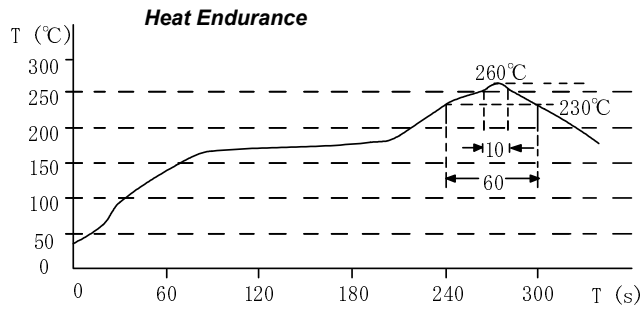

Please refer to the sales offices on our website - <http://www.sumida.com>

### Hong Kong

Tel.+852-2880-6688  
FAX.+852-2565-9600  
[sales@hk.sumida.com](mailto:sales@hk.sumida.com)

### Tokyo

Tel.+81-3-5202-7112  
FAX.+81-3-5202-7105  
[sales@jp.sumida.com](mailto:sales@jp.sumida.com)

### Chicago

Tel.+1-847-545-6700  
FAX. +1-847-545-6720  
[sales@us.sumida.com](mailto:sales@us.sumida.com)

### Shanghai

Tel.+86-021-5836-3299  
FAX.+86-021-5836-3266  
[shanghai.sales@cn.sumida.com](mailto:shanghai.sales@cn.sumida.com)

### Seoul

Tel.+82-2-6237-0777  
FAX.+82-2-6237-0778  
[sales@kr.sumida.com](mailto:sales@kr.sumida.com)

### Oberzell

Tel.+49-8591-937-0  
FAX. +49-8591-937-103  
[contact@sumida-eu.com](mailto:contact@sumida-eu.com)

### Shenzhen

Tel.+86-755-8291-0228  
FAX.+86-755-8291-0338  
[shenzhen.sales@cn.sumida.com](mailto:shenzhen.sales@cn.sumida.com)

### Singapore

Tel.+65-6296-3388  
FAX.+65-6296-3390  
[sales@sg.sumida.com](mailto:sales@sg.sumida.com)

### Neumarkt

Tel.+49-9181-4509-110  
FAX. +49-9181-4509-310  
[infocomp@eu.sumida.com](mailto:infocomp@eu.sumida.com)

### Taipei

Tel.+886-2-8751-2737  
FAX.+886-2-8751-2738  
[sales@tw.sumida.com](mailto:sales@tw.sumida.com)

### San Jose

Tel.+1-408-321-9660  
FAX.+1-408-321-9308  
[sales@us.sumida.com](mailto:sales@us.sumida.com)