

30x30x15 mm

4.8~6.0 CFM



■ Specifications

	Bearing	Rating Voltage	Power Current	Power Consumption	Speed	Air Flow	Static Pressure	Noise	Weight	Curve
	● VAPO	(VDC)	(mA)	(WATTS)	(RPM)	(CFM)	(Inch-H ₂ O)	(dB(A))	(g)	
MC30150V1-000U-A99	●	5	114	0.57	8500	6.0	0.17	27.0	13.5	1
MC30150V2-000U-A99	●	5	75	0.37	7000	4.8	0.12	20.0	13.5	2
MC30151V1-000U-A99	●	12	54	0.65	8500	6.0	0.17	27.0	13.2	1
MC30151V2-000U-A99	●	12	37	0.45	7000	4.8	0.12	20.0	13.2	2

■ Air Flow-Static Pressure Characteristics

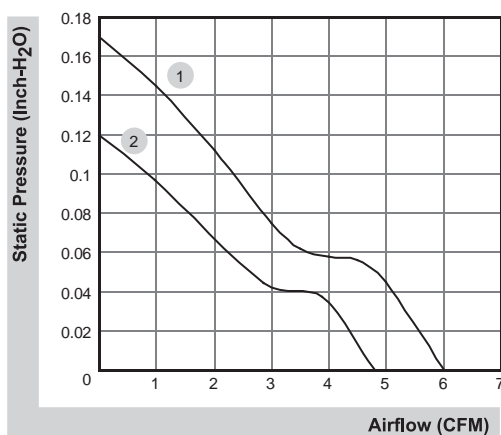

■ External dimensions(mm)

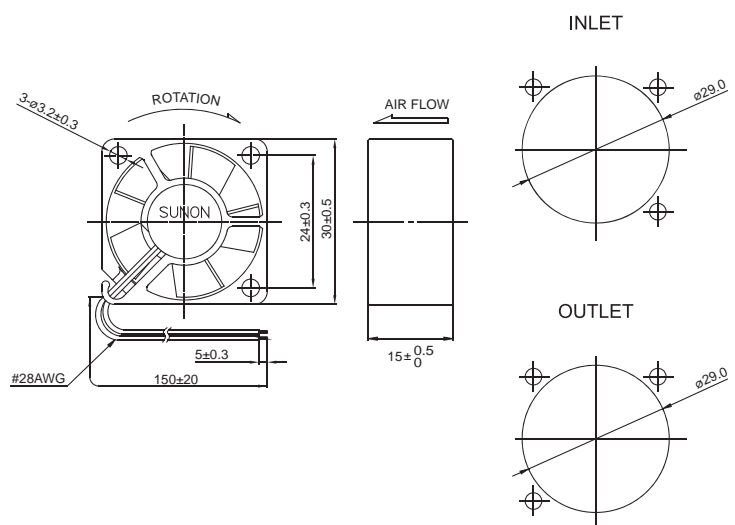

*All model could be customized. Please contact with Sunon Sales.

*Specifications are subject to change without notice. Please Visit SUNON website at <http://www.sunon.com> for update information.