



HD30 & HDP20 Series Technical Manual



HD30 & HDP20 Series Technical Manual

HD/HDP Series - Heavy Duty Field - Proven Interconnection Systems



Truck Applications

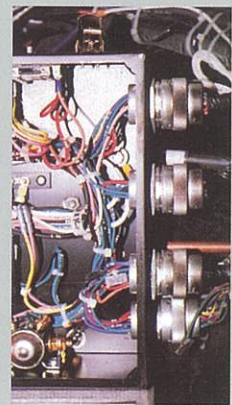
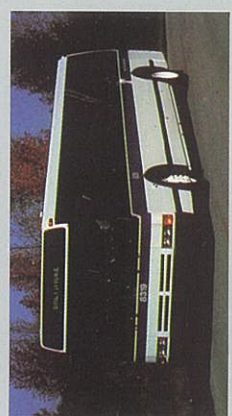

Bus Applications

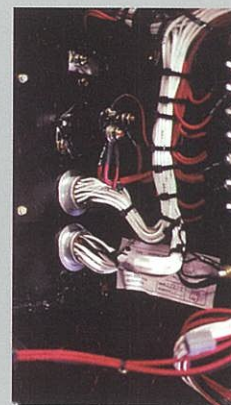

Farm Equipment

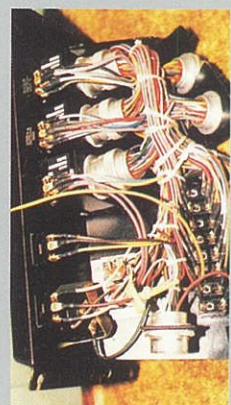
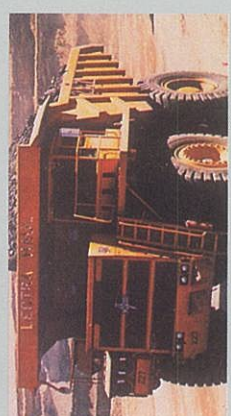

Construction Equipment

Ordering Information	8
Insert Arrangements	9
Usable Wire Sizes	10
Envelope Drawings	11
Receptacle Mounting / Mating / Unmating Instructions	12
Assembly Instructions	13
Contacts	14
HD30/HDP20 Accessories	15

Deutsch HD30 Series

A heavy duty, environmentally sealed, multi-pin circular connector, featuring quick connect-disconnect bayonet coupling, single hole bulkhead mounting, silicone seals, with a rear insertion/rear removal contact system.

The Deutsch HD30 Series connector, was developed to meet the needs of the heavy duty equipment and transportation industries for rugged, multi-pin, sealed connector systems.



Designed specifically for the truck, bus and off-highway industry, the HDP20 Series is a heavy duty rated, environmentally sealed, composite shell, multi-pin connector. The plug features a quick connect-disconnect bayonet style coupling and the receptacle is designed for single hole mounting. Thus reducing assembly line time and installation costs.

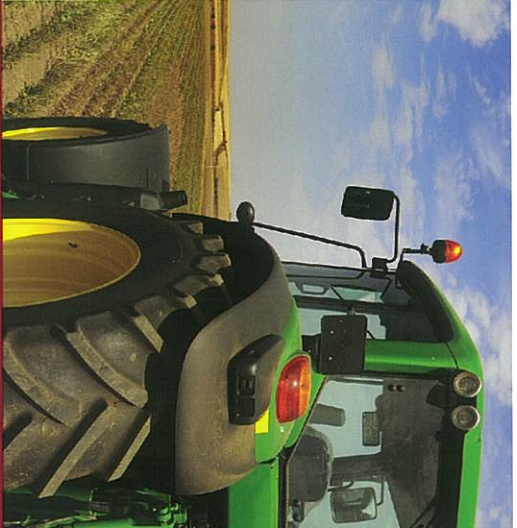

A STEP AHEAD



The HD/HDP Series

Decreases Costs and UP-Grades Performance

The Deutsch HD/HDP Series was developed to provide a solution to today's system problems found in the heavy duty trucking, equipment and transportation industries. The HD/HDP is a cylindrical, multi-pin, sealed device utilizing crimp type contacts that are quickly and easily inserted or removed. Use of the HD/HDP Series eliminates several other common connector problems.

Problems associated with assembly and network time, operational breakdowns requiring costly repairs and lengthy out of service time in the field have all been reduced and/or eliminated by the judicious application of the HD/HDP Series.

Deutsch HD/HDP Series provide the widest selection of interconnections for critical circuits requiring heavy-duty environmental terminations. Together, the HD and HDP offer common layouts, common tooling, the same adaptability to backshells and both meet the performance standards for heavy duty applications. So whether you are looking for rugged HD metal shells or cost effective HDP plastic shells, Deutsch offers the best product for your applications while holding the line on hidden inventory and assembly costs.



Some of the benefits of the Deutsch HD/HDP Series include:

- Quick, fool-proof assembly, decreasing time on the assembly line and eliminating miswiring.



Electrical Connectors:

Critical to System Reliability and Maintainability

Recent studies indicate that electrical system failures are a common and constant source of equipment malfunction. A major area of electrical system failure is in electrical interconnections. Typical problems include loose and miswired terminals, corrosion, and contamination of terminals. Coupled with these problems, the impact of sophisticated safety devices, automated check-out systems, and other increased use of electronics, call for a re-examination of traditional termination techniques. To the operator, termination failures mean excessive down time and maintenance costs. This adds up to slipped production schedules, cost over-runs and user problems. The end result: decreased profits and a loss of share of the market. In today's competitive arena, improved electrical connectors can make the difference between a growing, profitable operation or a losing one.

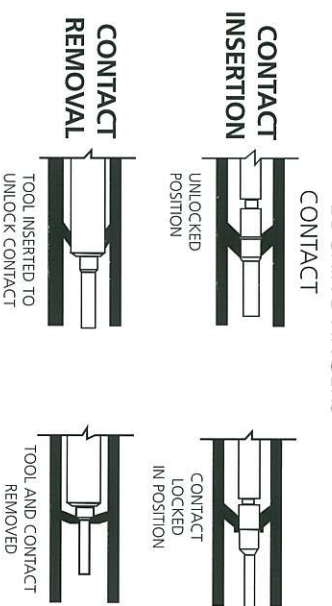

Sealed Against Moisture and Contaminants

Unlike terminal strips, binding posts and other open-wiring systems, the Deutsch HD/HDP Series is a completely sealed unit. The rear of the connector features an integral grommet wire seal that automatically seals each contact as it is locked into place during installation. There is no extra hardware to fasten or tighten or potting operation to achieve this seal.

Fabricated from tear resistant, high temperature silicone, this rear grommet protects the contact from moisture, sand, dust, lubricating oils, road salt, hydraulic fluid, grease, mud and other contaminants encountered in heavy duty use. The elimination of open-wiring systems does away with such common hazards as short circuits due to metallic objects across the terminals. This is especially important during loading or refueling operation when a spark could cause a serious explosion. Closed wiring also protects maintenance personnel against accidental shock, yet can be easily checked for circuit continuity.

Contact Retention Decreases Installation Costs and Increases Reliability

The HD/HDP Series uses crimp type, solid copper alloy contacts for damage proof performance and stamped & formed copper alloy contacts for cost effectiveness. Each style has the ability to carry continuous high operating current loads without overheating. The contacts or terminals are crimp terminated using automatic tooling for production and inexpensive readily available hand tools for field maintenance. After crimping, these contacts are easily installed by simply pushing the contact into place by hand. Contacts are positively secured by use of "fingers" in the connector which lock behind the

Corrosion Proof Plastic Shell HDP20 Series Provide a Cost Effective Alternative

Deutsch plastic shell HDP20 Series provide cost effectiveness with heavy duty terminations for the truck, bus & off-highway industries. Other features include: silicone wire and interfacial seals, visual indication of lock and mated position. Corrosion proof plastic shells and use of low cost stamped and formed contacts provides a cost effective solution for your application.

The HDP20 uses a bayonet coupling system to provide a vibration resistant locking mechanism. This shell provides a multiple keying system that positively prevents mismatching and makes plug and receptacle coupling quick and easy. Receptacles mount with a single hole using a "flat" to prevent the connector from rotating.



Rugged Metal Shell HD30 Series Withstands Years of Abuse

Deutsch HD30 Series features a lightweight, yet compact and rugged metal shell to protect contacts and sealing grommets. This shell provides a multiple keying system that positively prevents mismatching and makes plug and receptacle coupling quick and easy.

The HD30 Series uses a bayonet coupling system that provides a positive vibration resistant locking mechanism with visual indication of proper mate and lock. This quick disconnect system requires only a quarter turn to operate.

Easy installation to structure is provided by a single one-hole mounting system using a "flat" to prevent the connector from rotating during assembly or service.

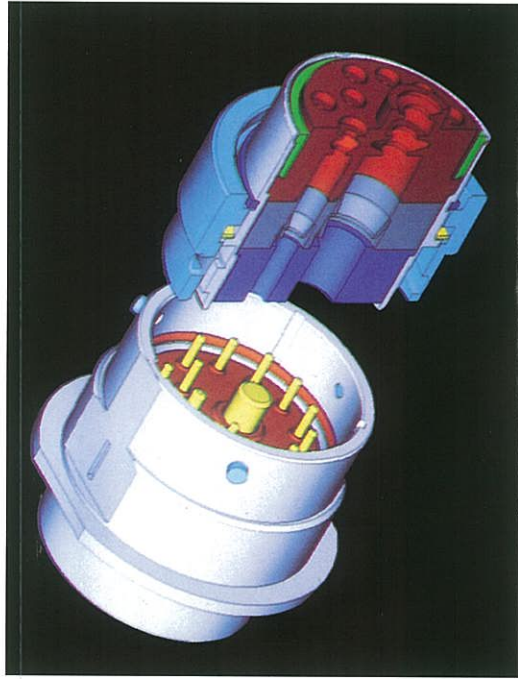

HD/HDP Series Connector Features

Deutsch HD/HDP Series environmental connectors offer the advantages of decreased costs and upgraded performance. Designed to withstand years of abuse, the Deutsch HD/HDP Series is setting the pace in the Heavy Equipment Industry. Key features common to the HD/HDP Series are itemized below.

I. Contacts

- A. Solid copper alloy construction withstands continuous current overload without degradation.
Cost effective stamped and formed contacts provide high reliability and low cost.
- B. Range of contact and acceptable wire sizes
 1. Size #4 AWG 6 (13.0 mm²)
 2. Size #8 AWG 8 & 10 (8.0 – 5.0 mm²)
 3. Size #12 AWG 12 & 14 (4.0 – 2.0 mm²)
 4. Size #16 AWG 14 & 20 (0.5 – 2.0 mm²)
 5. Size #20 AWG 16 & 22 (0.5 – 1.5 mm²)
- C. Closed entry socket contact design assures positive conductivity and eliminates probe damage.
- D. Simplified pin contact design limits possibility of bending.

II. Inserts

- A. The hard plastic insert and closed contact interface

- E. Redundant wire seals prevent contamination from entering from rear of connector.
- F. Sealing plug to fill unused cavities to keep environmental sealing characteristics intact.

III. Shell

- A. Rugged, all metal shell to withstand years of abuse (HD30) Corrosion resistant all plastic shell (HDP20) has same features (item C).
- B. Positive shell keying prevents mismating.
- C. Simple, one quarter turn coupling.
 1. Free rotating, captivated coupling ring for fast assembly.
 2. Coupling ring designed to insure proper environmental sealing with minimum mating forces.
 3. Audio and visual indications of positive locked condition.
- D. Available in a straight plug and single hole mounting receptacle for easy installation to structure.

IV. Application Tooling

- A. Standard crimp tool or semi-automated, high-speed crimping tool is available.
 1. Fast, reliable, uniform results

HD/HDP Mounting Hardware

Panel Nut: Aluminum, Plastic
Lockwasher: Spring Steel - Tin over Nickel

Solid Contacts

Pin: Copper Alloy
Socket: Copper Alloy
Finish: Nickel plating
Optional: Gold plating
is available for dry circuit applications

Stamped & Formed Contact

Pin: Copper Alloy
Socket: Copper Alloy
Finish: Nickel plating
Optional: Gold plating is available for dry circuit applications

Sealing Plugs

Thermoplastic: Size 20 thru 8
Elastomer: Size 4

Performance Specifications

Temperature

Operating at temperatures from -55° C to + 125° C.
Continuous at rated current

Durability

No electrical or mechanical defects after 100 cycles of engagement or disengagement.

Physical Shock

No unlocking unmating or other unsatisfactory result during or after 50 g's in each of three mutually perpendicular planes. No electrical discontinuities longer than 1 microsecond. MIL-STD 202, Method 213, Condition "C".

Contact Current Rating @ 125°C (continuous)

Contact Size	Max. Current
#20	7.5 amps
#16	13 amps
#12	25 amps
#8	60 amps
#4	100 amps

Water does not penetrate seals when submerged in 3 feet of water.

Corrosion Resistance

Connectors show no evidence of corrosion after exposure to 48 hours of salt spray per MIL-STD 1344 method 1001.

Fluid Resistance

Connectors show no damage when exposed to most fluids used in industrial applications.

Dielectric Withstanding Voltage:

Current leakage less than 2 milliamperes at 1500 VAC.

Crimp Tensile Strength: (Solid & Stamped)

#20	Size	Contacts	20 lbs.
#16	Size	Contacts	25 lbs.
#12	Size	Contacts	70 lbs.
#8	Size	Contacts	90 lbs.
#4	Size	Contacts	300 lbs.

CONTACT RESISTANCE

CONTACT SIZE	WIRE GAUGE AWG(mm ²)	Test Current (Amps)	Resistance (mV) Solids	Resistance (mV) Stamped & Formed
20	20 (.50)	7.5	60	100
	18 (.80)	7.5	60	100
16	16 (1.0)	7.5	60	100
	20 (.50)	7.5	60	100
12	18 (.80)	10	60	100
	16 (1.0)	13	60	100
8	14 (2.0)	13	60	100
	14 (2.0)	18	60	100
4	12 (3.0)	25	60	100
	8 (8.60)	60	60	N/A
4	10 (5.60)	60	60	N/A
	6 (13.0)	100	60	N/A



PART NUMBERING SYSTEM

HD X 36 - 24-21 SN - XXX

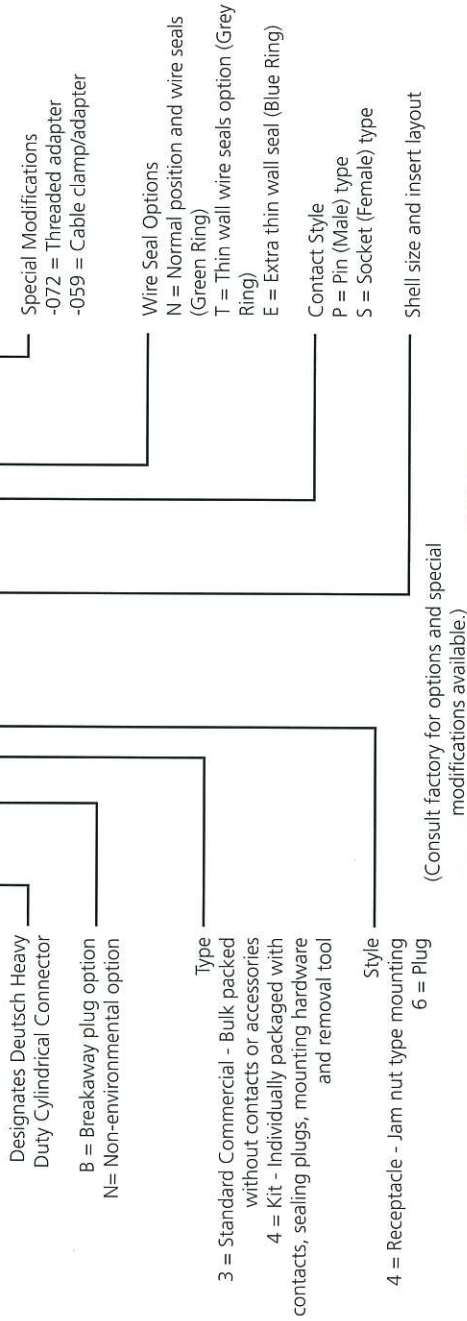

PART NUMBERING SYSTEM

HDP 26 - 24-21 SN - XXXX

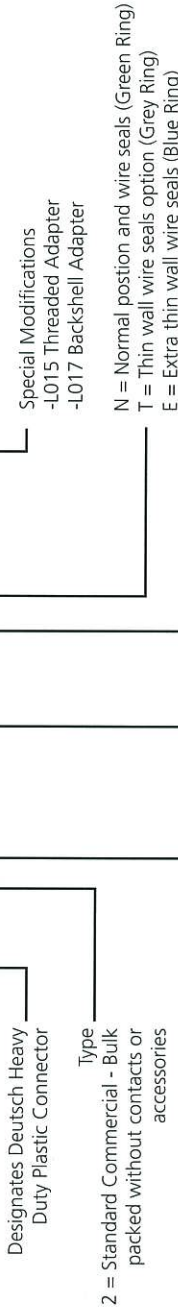

2 size 4, 4 size 10
 8 size 12
 14 size 16
 2 size 16 & 18 size 20
 21 size 20
 N, E***
 N, E
 N, E, T
 N, E
 N

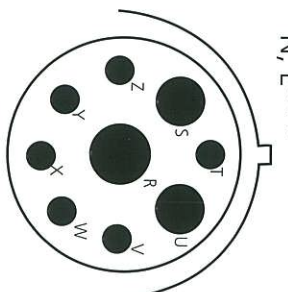

24-9*

1 size 4, 2 size 8
 & 6 size 12**
 N, E***

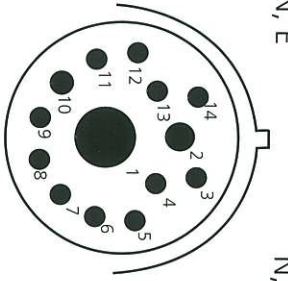

24-14

1 size 4, 1 size 12
 & 12 size 16
 N, E

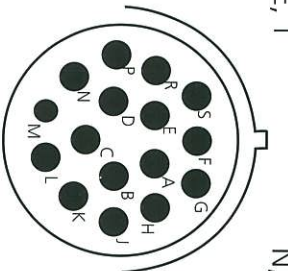

24-16

16 size 12
 N, E

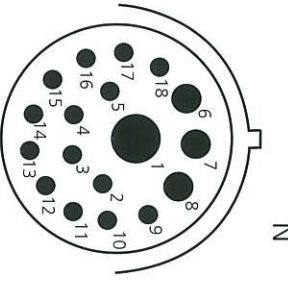

24-18

1 size 8, 3 size 12
 & 14 size 16
 N, E

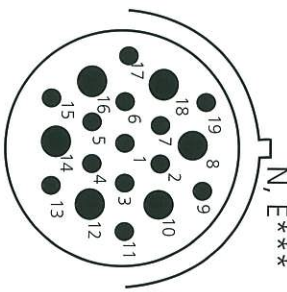

24-19

6 size 12
 & 13 size 16
 N, E

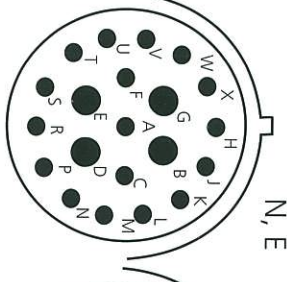

24-21

4 size 12
 & 17 size 16
 N, E

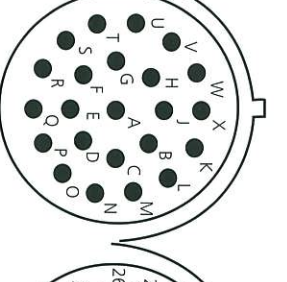

24-23

23 size 16
 N, T, E

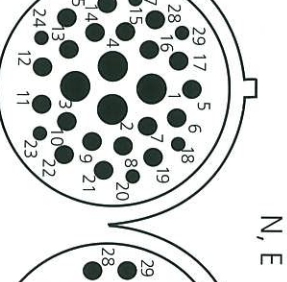

24-29

4 size 12, 19 size 16
 & 6 size 20
 E

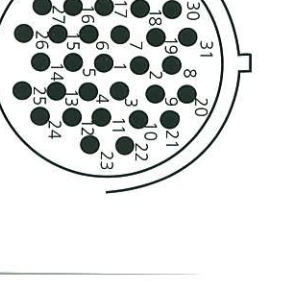

24-31

31 size 16
 T, E

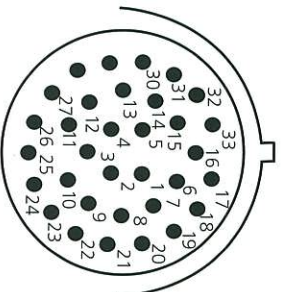

24-33

33 size 20
 N

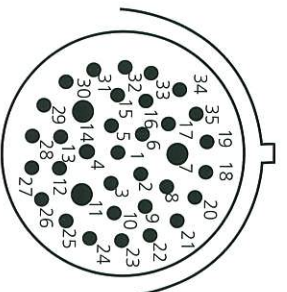

24-35

3 size 16
 & 32 size 20
 N, E

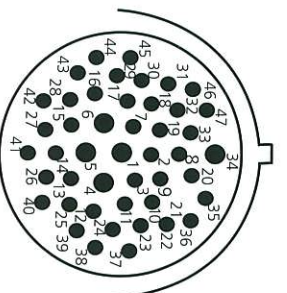

24-47

5 size 16
 & 42 size 20
 E

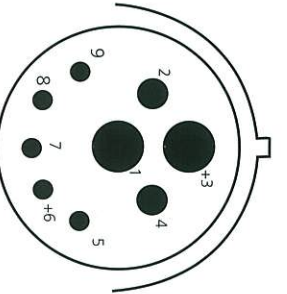

24-91

2 size 8, 2 size 12
 & 5 size 16
 N, E

* Arrangement
 ** Description
 *** Rear Seal



HD30 & HDP20 Series Technical Manual

USABLE WIRE SIZE

INSERT ARRANGEMENT	SEAL TYPE		
	N	T	E
18-6	✓		✓
18-8	✓		✓
18-14	✓	✓	✓
18-20	✓		✓
18-21	✓		
24-9	✓		✓
24-14	✓		✓
24-16	✓		✓
24-18	✓		✓
24-19	✓		✓
24-21	✓		✓
24-23	✓	✓	✓
24-29			✓ *2
24-31		✓ *1	✓ *2
24-33	✓		
24-35	✓		✓
24-47			✓ *2
24-91	✓		✓

CONTACT SIZE	RECOMMENDED WIRE INSULATION O.D. FOR:		
	N-SEAL Green Ring	T-SEAL Grey Ring	E-SEAL Blue Ring
#20	.040-.095 (1.02-2.41)	.040-.095 (1.02-2.41)	.040-.095 (1.02-2.41)
#16	.100-.134 (2.54-3.40)	.088-.134 (2.23-3.40)	.053-.120 (1.35-3.05)
#12	.134-.170 (3.40-4.32)	.113-.170 (2.87-4.32)	.097-.158 (2.46-4.01)
#8	.190-.240 (4.83-6.10)	.170-.240 (4.32-6.10)	.135-.220 (3.43-5.59)
#4	.280-.292 (7.11-7.42)	.261-.292 (6.63-7.42)	.261-.292 (6.63-7.42)

*1 Modified "T" Seal. See envelope print

*2 Modified "E" Seal. See envelope print

Connector Identification

COLOR CODED RING



Color code is visible from the rear of the receptacle or plug.

Series Plug

SHELL SIZE	A MAX DIA	B DIA +.010
18	1.692 (42.98)	1.220 (30.99 ±0.25)
24	1.942 (49.33)	1.470 (37.34 ±0.25)

Panel Nut**

PART NUMBER	SHELL SIZE	A +.030	B THREAD
METAL 114020-90*	18	1.685	1-1/2 - 18
PLASTIC 2411-002-1805	18	(42.80 +.76)	UNEF-2B
METAL 112263-90*	24	1.875	1-1/16-18
PLASTIC 2411-001-2405	24	(47.63 +.76)	UNEF-2B

PANEL NUT MOUNTING TORQUE

HD30 18 SHELL SIZE	260-280 IN. LB. (29.4-31.6 N.M.)
HDP20 18 SHELL SIZE	45-55 IN. LB. (5.1-6.1 N.M.)
HD30 24 SHELL SIZE	350-375 IN. LB. (39.5-42.6 N.M.)
HDP20 24 SHELL SIZE	65-75 IN. LB. (7.4-8.4 N.M.)

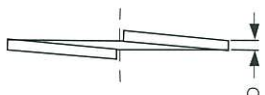
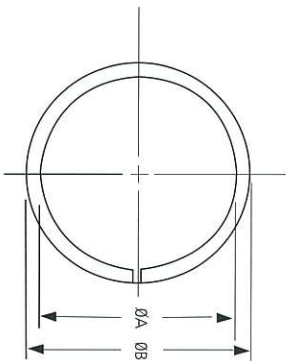
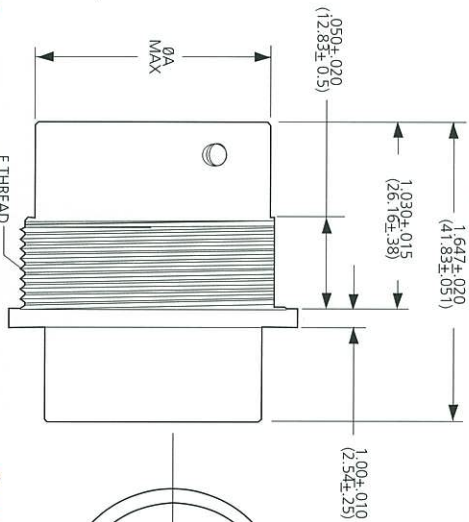
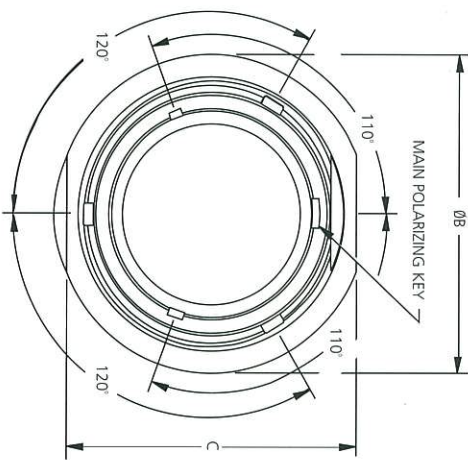

Series Receptacle

Panel Lockwasher*

SHELL SIZE	A ±.025	B ±.025	C ±.025	F THREAD
18	1.329 (33.76 ±0.63)	1.750 (44.45 ±0.63)	1.625 (41.28 ±0.63)	1 1/2-18 UNEF
24	1.579 (40.11 ±0.63)	2.000 (50.80 ±0.63)	1.875 (47.63 ±0.63)	1 1/16-18 UNEF

PART NO.	SHELL SIZE	A DIA. ±.015	B DIA. ±.010	C REF ±.015
114021*	18	1.512	1.886	.062 (1.57 ±.38)
2414-002-1886**	18	(38.40 ±.38)	(47.90 ±.25)	.020 (0.51 ±.38)
112264*	24	1.70	2.074	.062 (1.57 ±.38)
2414-001-2486**	24	(43.18 ±.38)	(52.68 ±.25)	.020 (1.57 ±.38)

* Metal Panel Nuts are used on HD30 only.
** For use on HDP20.



Receptacle Mounting

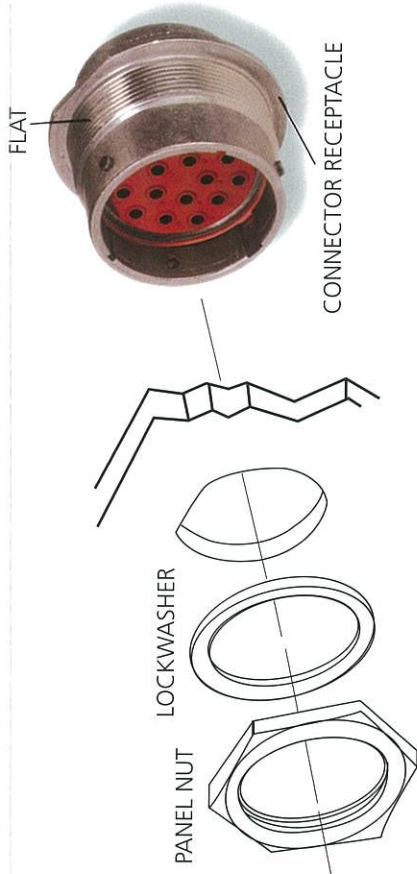

See Information Drawing 0425-016-0000

RECOMMENDED SIZE OF MOUNTING HOLE		
SHELL SIZE	A0	B
18	1.507 (38.28)	1.442 (36.63)
24	1.696 (43.08)	1.632 (41.45)

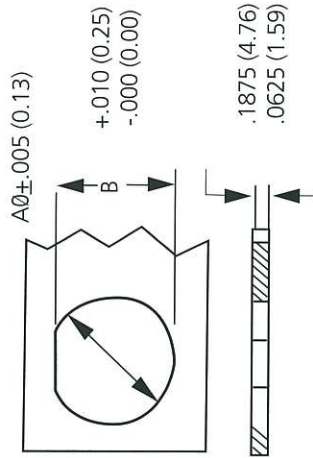

"D" Hole Punches available from: LADD Industrial Sales.

Mating / Unmating Instructions

To mate the plug and the receptacle, line up the index groove on the plug with the flat surface on the receptacle, turn 1/4 turn clockwise. You will feel and hear the pieces snap into the locked position. To unmate the plug and receptacle, reverse the above procedure.



VISUALLY INSPECTABLE
BAYONET FOR PROPER MATING

POLARIZING INDICATOR

HDP20 SERIES & HD30 SERIES

MATE



1 Grasp contact approximately (25.4 mm) one inch behind the contact crimp barrel.



2 Hold connector with rear grommet facing you.

NOTE: For unused wire cavities, insert sealing plugs for full environmental sealing.



3 Push contact straight into connector grommet until a positive stop is felt. A slight tug will confirm that it is properly locked in place.

Contact Removal



1 With rear insert toward you, snap appropriate size extractor tool over the wire of contact to be removed.

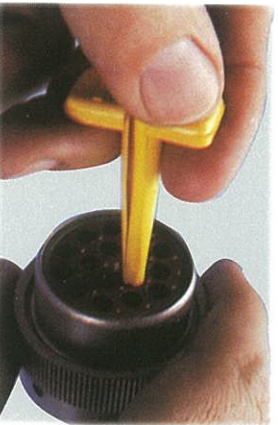

2 Slide tool along into the insert cavity until it engages contact and resistance is felt.



3 Pull contact-wire assembly out of connector.

NOTE: Do not twist or insert tool at an angle.

Removal Tools

Sealing Plugs

NORMAL WIRE SEALS (N)

PART NO.	SIZE	WIRE RANGE AWG
0411-240-2005	20	20-22
0411-204-1605	16	14-20
114010	12	12-14
114008	8	8-10
114009	4	6

EXTRA THIN WALL WIRE SEALS (E)

PART NO.	SIZE	WIRE RANGE AWG
0411-240-2005	20	20-22
0411-336-1605	16	14-20
0411-337-1205	12	12-14
0411-353-0805	8	8-10
114009	4	6

SEALING PLUG

CONTACT SIZE	PART NO.
20	0413-204-2005
12-16	114017
8	114018
4	114019

THIN WALL WIRE SEALS (T)

0411-310-1605	16	14-20
---------------	----	-------



HD30 & HDP20 Series Technical Manual

CONTACTS AND APPLICATION DATA

Solid Contacts

SIZE	SOLID CONTACT PART NUMBERS		WIRE SIZE AWG (mm ²)	RECOMMENDED STRIP LENGTH INCHES (mm)	MIN CONTACT RETENTION LBS (N)	REF CRIMP TENSILE LBS (N)	MAX RATED AMPS AT 125°C CONTINUOUS
	PIN	SOCKET					
20	0460-202-20**	0462-201-20**	20 (0.50)	.156 - .218 (3.96 - 5.54)	20 (89)	20 (89)	7.5
20	0460-010-20**	0462-005-20**	16 - 18 (1.0 - 0.75)	.156 - .218 (3.96 - 5.54)	20 (89)	20 (89)	7.5
16	0460-202-16**	0462-201-16**	16 - 20 (1.0 - 0.50)	.250 - .312 (6.35 - 7.92)	25 (111)	35-20 (156 - 89)	13
16	0460-215-16**	0462-209-16**	14 (2.0)	.250 - .312 (6.35 - 7.92)	25 (111)	70 (311)	13
12	0460-204-12**	0462-203-12**	12 - 14 (3.0 - 2.0)	.222 - .284 (5.64 - 7.21)	30 (134)	75-70 (334 - 311)	25
8	0460-204-08**	0462-203-08**	8-10 (8.0 - 5.0)	.430 - .492 (10.92 - 12.50)	35 (156)	125-90 (556 - 400)	60
4	0460-204-04**	0462-203-04**	6 (13.0)	.430 - .492 (10.92 - 12.50)	35 (156)	300 (1334)	100

* See Envelope Print 0425-205-0000. Consult factory for alternate finishes.

Solid Contacts

Stamped and Formed Contacts

Socket

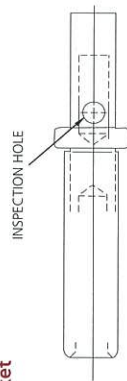

Pin

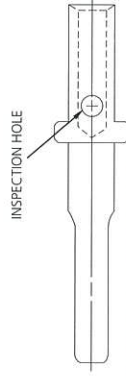

Pin

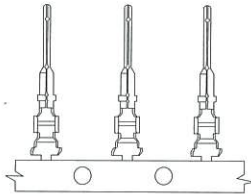

Socket

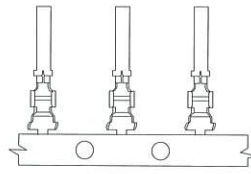

Stamped & Formed Contacts

SIZE	STAMPED & FORMED CONTACT PART NUMBERS		CARRIER STRIP IDENTIFICATION	WIRE SIZE AWG (mm ²)	WIRE INSULATION O.D. RANGE	RECOMMENDED STRIP LENGTH INCHES (mm)	MIN CONT. RETENTION LBS (N)	REF CRIMP TENSILE LBS (N)	MAX RATED AMPS AT 125°C CONTINUOUS
	PIN	SOCKET							
20	1060-20-01**	1062-20-01**	20 - 01	16 - 22 (1.0 - 0.35)	.075 - .125 (1.91 - 3.15)	.150 - .200 (3.81 - 5.08)	20 (89)	20 - 10 (89 - 45)	7.5
20	1060-20-02**	1062-20-02**	20 - 02	16 - 22 (1.0 - 0.35)	.051 - .085 (1.30 - 2.16)	.150 - .200 (3.81 - 5.08)	20 (89)	20 - 10 (89 - 45)	7.5
20	N/A	1062-20-03**	20 - 03	16 - 22 (1.0 - 0.35)	.075 - .125 (1.91 - 3.15)	.150 - .200 (3.81 - 5.08)	20 (89)	20 - 10 (89 - 45)	7.5
20	1060-20-06**	1062-20-06**	20 - 06	14 - 16 (2.5 - 1.0)	.075 - .125 (1.91 - 3.15)	.150 - .200 (3.81 - 5.08)	20 (89)	20 - 10 (89 - 45)	7.5
16	1060-14-01**	1062-14-01**	14-16	14 - 16 (2.5 - 1.0)	.095 - .150 (2.41 - 3.81)	.150 - .200 (3.81 - 5.08)	25 (111)	25 (111)	13
16	1060-14-10**	1062-14-10**	14-16	14 - 18 (2.0 - .75)	.095 - .150 (2.41 - 3.81)	.150 - .200 (3.81 - 5.08)	25 (111)	25 (111)	13
16	1060-16-01**	1062-16-01**	16 - 18	14 - 18 (2.0 - .75)	.075 - .140 (1.91 - 3.55)	.150 - .200 (3.81 - 5.08)	25 (111)	25 (111)	13
16	1060-16-06**	1062-16-06**	0.5 - 1.0	16 - 20 (1.0 - 0.50)	.055 - .100 (1.40 - 2.54)	.150 - .200 (3.81 - 5.08)	25 (111)	25 - 15 (111 - 67)	13
16	1060-16-07**	1062-16-07**	0.75 - 2.0	14 - 18 (2.0 - .75)	.075 - .140 (1.91 - 3.55)	.150 - .200 (3.81 - 5.08)	25 (111)	25 (111)	13
16	1060-16-09**	1062-16-09**	16 - 18	14 - 18 (2.0 - .75)	.075 - .140 (1.91 - 3.55)	.150 - .200 (3.81 - 5.08)	25 (111)	25 (111)	13

Connector P/N

HDP2*-24-*-L015**

Available in plugs and receptacles
Connecting hardware available through distribution



HDP2*-24-*-L017**

HDP2*-18-**-L017**
Available in plugs and receptacles



Cable Clamp*

*Metal Shells Only

- 072 ADAPTOR ONLY
- 059 WITH DRAIN HOLES
- L006 WITHOUT DRAIN HOLES

Straight Backshell P/N

2428-008-2405



2428-004-2405



Locking tabs ensure closure



Straight Strain Relief (Aluminum)

SIZE	PART NO.
24	WHDS-24-1
18	WHDS-18-1



90° Strain Relief (Aluminum)

SIZE	PART NO.
24	WHDS-24-2
18	WHDS-18-2

(Connector shown for reference only.)

HDB - HD30 Series Only Breakaway Plug

Designed to interconnect with the HD30 Series receptacles and provide an emergency disconnect between farm tractors and implements requiring power connections. HDB - Breakaway Plugs can be specified with pin or socket contacts and cable clamps (-059 mod). Minimum force required to emergency disconnect is 50 lbs. Maximum force required is 100 lbs. Mate with HD30 Series Only.



SIZE	PART NO.
24	HDB 36-24-XXSN-059
18	HDB 36-18-XXSN-059

Protective Caps

Plug cap for receptacle protection (Aluminum)



SIZE	PART NO.	WITHOUT MTG CHAIN (ADD)
24	HDC 36-24	-1 E
18	HDC 36-18	-1 E

Protective Caps

Receptacle cap for plug protection (Aluminum)



SIZE	PART NO.	WITHOUT MTG CHAIN (ADD)
24	HDC 34-24	-1 E
18	HDC 34-18	-1 E

Deutsch Industrial UK
Stanier Road
St. Leonards On Sea
East Sussex TN 38 9RF
England
Ph. 44 (0) 1424 852 722
Fax 44 (0) 1424 855 979
industrialuk@deutsch.net

Deutsch Industrial Europe
Fraunhoferstrasse 11b
82152 Martinsried
Germany
Ph. +49 (0) 89 899157-0
Fax +49 (0) 89 857 4684
info.eu@deutsch.net

Deutsch Connectors Trading
(Shanghai) Co., Ltd.
Room 1032, 10F Central Plaza,
381 Huai Hai Zhong Road,
Shanghai 200020, China
Tel/Fax: 86-21-6391 5902
E-mail: salesdichina@deutsch.net

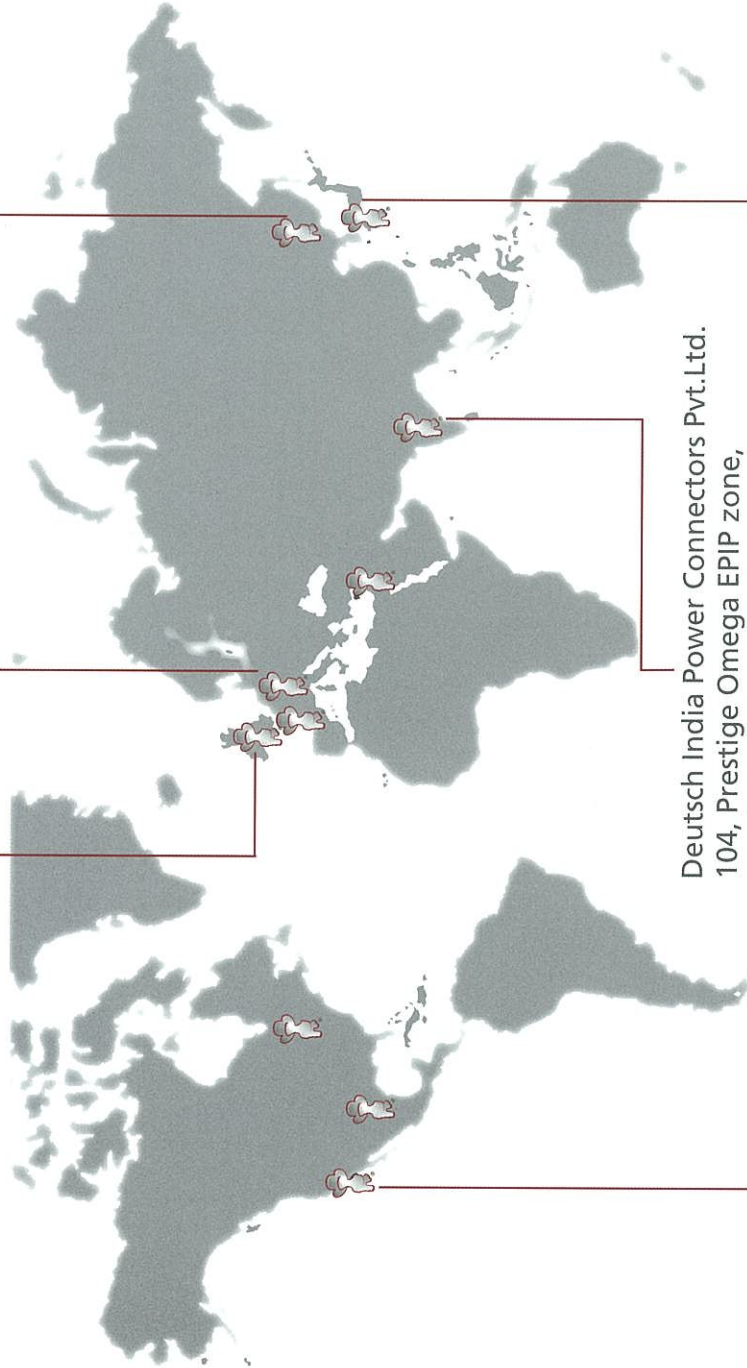

Deutsch Industrial US
3850 Industrial Ave.
Hemet, CA 92545
USA
Ph. +1 (951) 765-2250
Fax +1 (951) 765-2255
insidesales-ipd@deutsch.net

Deutsch India Power Connectors Pvt.Ltd.
104, Prestige Omega EPIP zone,
1st Phase, White Field,
Bangalore - 560 066.
INDIA.
Ph: +91 80 40466525
Mobile: +91 98454 03301

Deutsch Industrial Japan
NIHON Deutsch Ltd.
44-10, Ohyamakanai-cho
Itabashi-ku, Tokyo 173-0024
Japan
Ph. + 81-3-5995-5192
Fax + 81-305995-5193
rtakemura@nihon-deutsch.co.jp