

DS36950

DS36950 Quad Differential Bus Transceiver



Literature Number: SNLS075B

DS36950 Quad Differential Bus Transceiver

General Description

The DS36950 is a low power, space-saving quad EIA-485 differential bus transceiver especially suited for high speed, parallel, multipoint, computer I/O bus applications. A compact 20-pin surface mount PLCC package provides high transceiver integration and a very small PC board footprint.

Timing uncertainty across an interface using multiple devices, a typical problem in a parallel interface, is specified—minimum and maximum propagation delay times are guaranteed.

Six devices can implement a complete IPI master or slave interface. Three transceivers in a package are pinned out for

connection to a parallel databus. The fourth transceiver, with the flexibility provided by its individual enables, can serve as a control bus transceiver.

Features

- Pinout for IPI interface
- Compact 20-pin PLCC package
- Meets EIA-485 standard for multipoint bus transmission
- Greater than 60 mA source/sink
- Thermal Shutdown Protection

Pinout and Logic Diagram

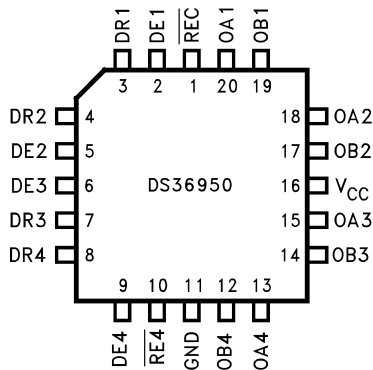

Order Number DS36950
See NS Package Number V20A

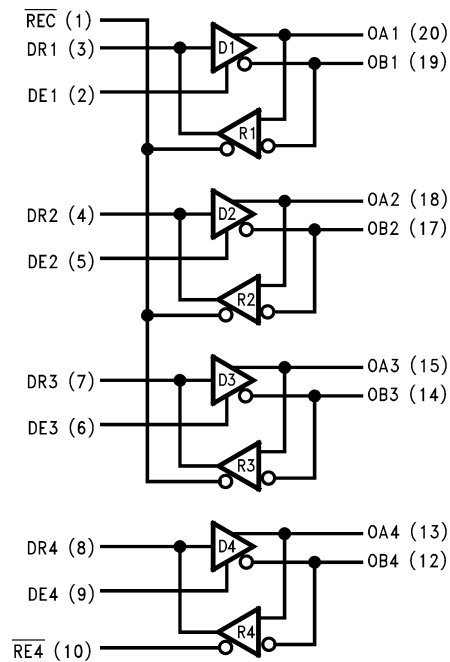

TRI-STATE® is a registered trademark of National Semiconductor Corporation.

Absolute Maximum Ratings (Note 1)

If Military/Aerospace specified devices are required, please contact the National Semiconductor Sales Office/Distributors for availability and specifications.

Supply Voltage	7V
Control Input Voltage	$V_{CC} + 0.5V$
Driver Input Voltage	$V_{CC} + 0.5V$
Driver Output Voltage/Receiver Input Voltage	-10V to +15V
Receiver Output Voltage	5.5V
Continuous Power Dissipation @ 25°C	
V Package	1.73W

Derate V Package 13.9 mW/°C above 25°C

Storage Temp. Range	-65°C to +150°C
Lead Temp. (Soldering 4 Sec.)	260°C

Recommended Operating Conditions

Supply Voltage, V_{CC}	4.75V to 5.25V
Bus Voltage	-7V to +12V
Operating Free Air Temp. (T_A)	0°C to +70°C

Electrical Characteristics (Note 2)

Over Supply Voltage and Operating Temperature ranges, unless otherwise specified

Symbol	Parameter	Conditions	Min	Typ	Max	Units
DRIVER CHARACTERISTICS						
V_{ODL}	Differential Driver Output Voltage (Full Load)	$I_L = 60 \text{ mA}$ $V_{CM} = 0V$	1.5	1.9		V
V_{OD}	Differential Driver Output Voltage (Termination Load)	$R_L = 100\Omega$ (EIA-422)	2.0	3.5		V
		$R_L = 54\Omega$ (EIA-485)	1.5	3.2		V
ΔV_{ODI}	Change in Magnitude of Driver Differential Output Voltage for Complementary Output States	$R_L = 54\Omega$ or 100Ω (Note 4) (Figure 1) (EIA-485)			0.2	V
V_{OC}	Driver Common Mode Output Voltage (Note 5)	$R_L = 54\Omega$ (Figure 1) (EIA-485)			3.0	V
ΔV_{OCI}	Change in Magnitude of Common Mode Output Voltage	(Note 4) (Figure 1) (EIA-485)			0.2	V
V_{OH}	Output Voltage HIGH	$I_{OH} = -55 \text{ mA}$	2.7	3.2		V
V_{OL}	Output Voltage LOW	$I_{OL} = 55 \text{ mA}$		1.4	1.7	V
V_{IH}	Input Voltage HIGH		2.0			V
V_{IL}	Input Voltage LOW				0.8	V
V_{CL}	Input Clamp Voltage	$I = -18 \text{ mA}$			-1.5	V
I_{IH}	Input High Current	$V_I = 2.4V$ (Note 3)			20	μA
I_{IL}	Input Low Current	$V_I = 0.4V$ (Note 3)			-20	μA
I_{OSC}	Driver Short-Circuit Output Current (Note 9)	$V_O = -7V$ (EIA-485)		-130	-250	mA
		$V_O = 0V$ (EIA-422)		-90	-150	mA
		$V_O = +12V$ (EIA-485)		130	250	mA
RECEIVER CHARACTERISTICS						
I_{OSR}	Short Circuit Output Current	$V_O = 0V$ (Note 9)	-15	-28	-75	mA
I_{OZ}	TRI-STATE® Output Current	$V_O = 0.4V$ to $2.4V$			20	μA
V_{OH}	Output Voltage High	$V_{ID} = 0.20V$, $I_{OH} = -0.4 \text{ mA}$	2.4	3.0		V
V_{OL}	Output Voltage Low	$V_{ID} = -0.20V$, $I_{OL} = 4 \text{ mA}$		0.35	0.5	V
V_{TH}	Differential Input High Threshold Voltage	$V_O = V_{OH}$, $I_O = -0.4 \text{ mA}$ (EIA-422/485)		0.03	0.20	V
V_{TL}	Differential Input Low Threshold Voltage (Note 6)	$V_O = V_{OL}$, $I_O = 4.0 \text{ mA}$ (EIA-422/485)	-0.20	-0.03		V
V_{HST}	Hysteresis (Note 7)	$V_{CM} = 0V$	35	60		mV
DRIVER AND RECEIVER CHARACTERISTICS						
V_{IH}	Enable Input Voltage High		2.0			V
V_{IL}	Enable Input Voltage Low				0.8	V

Electrical Characteristics (Note 2) (Continued)

Over Supply Voltage and Operating Temperature ranges, unless otherwise specified

Symbol	Parameter	Conditions	Min	Typ	Max	Units	
DRIVER AND RECEIVER CHARACTERISTICS							
V_{CL}	Enable Input Clamp Voltage	$I = -18 \text{ mA}$			-1.5	V	
I_{IN}	Line Input Current (Note 8)	Other Input = 0V	$V_I = +12\text{V}$		0.5	1	mA
			$V_I = -7\text{V}$		-0.45	-0.8	mA
I_{IH}	Enable Input Current High	$V_{OH} = 2.4\text{V}$	$\overline{RE4}$ or DE			20	μA
			\overline{REC}			60	μA
I_{IL}	Enable Input Current Low	$V_{OL} = 0.4\text{V}$	$\overline{RE4}$ or DE			-20	μA
			\overline{REC}			-60	μA
I_{CC}	Supply Current (Note 10)	No Load, Outputs Enabled		75	90	mA	
I_{CCZ}	Supply Current (Note 10)	No Load, Outputs Disabled		50	70	mA	

Switching Characteristics

Over Supply Voltage and Operating Temperature ranges, unless otherwise specified

Symbol	Conditions	Min	Typ	Max	Units	
DRIVER SINGLE-ENDED CHARACTERISTICS						
t_{PZH}	$R_L = 110\Omega$ (Figure 4)		35	40	ns	
t_{PZL}	$R_L = 110\Omega$ (Figure 5)		25	40	ns	
t_{PHZ}	$R_L = 110\Omega$ (Figure 4)		15	25	ns	
t_{PLZ}	$R_L = 110\Omega$ (Figure 5)		35	40	ns	
DRIVER DIFFERENTIAL CHARACTERISTICS						
t_R, t_F	Rise & Fall Time	$R_L = 54\Omega$		13	16	ns
t_{PLHD}	Differential Propagation	$C_L = 50 \text{ pF}$	9	15	19	ns
t_{PHLD}	Delays (Note 15)	$C_D = 15 \text{ pF}$	9	15	19	ns
t_{SKD}	$ t_{PLHD} - t_{PHLD} $ Differential Skew	(Figures 3, 8)		3	6	ns
RECEIVER CHARACTERISTICS						
t_{PLHD}	Differential Propagation Delays		9	14	19	ns
t_{PHLD}	$C_L = 15 \text{ pF}, V_{CM} = 1.5\text{V}$ (Figure 6)		9	14	19	ns
t_{SKD}	$ t_{PLHD} - t_{PHLD} $ Differential Receiver Skew			1	3	ns
t_{ZH}	Output Enable Time to High Level	$C_L = 15 \text{ pF}$ (Figure 7)		15	22	ns
t_{ZL}	Output Enable Time to Low Level			20	30	ns
t_{HZ}	Output Disable Time from High Level			10	17	ns
t_{LZ}	Output Disable Time from Low Level			17	25	ns

Note 1: "Absolute Maximum Ratings" are those values beyond which the safety of the device cannot be guaranteed. They are not meant to imply that the devices should be operated at these limits. The tables of "Electrical Characteristics" specify conditions for device operation.

Note 2: Current into device pins is define as positive. Current out of device pins is defined as negative. All voltages are referenced to ground unless otherwise specified.

Note 3: I_{IH} and I_{IL} includes driver input current and receiver TRI-STATE leakage current.

Note 4: ΔV_{OD} and ΔV_{OC} are changes in magnitude of V_{OD} and V_{OC} , respectively, that occur when the input changes state.

Note 5: In EIA Standards EIA-422 and EIA-485, V_{OC} , which is the average of the two output voltages with respect to ground, is called output offset voltage, V_{OS} .

Note 6: Threshold parameter limits specified as an algebraic value rather than by magnitude.

Note 7: Hysteresis defined as $V_{HST} = V_{TH} - V_{TL}$.

Note 8: I_{IN} includes the receiver input current and driver TRI-STATE leakage current.

Note 9: Short one output at a time.

Note 10: Total package supply current.

Note 11: All typicals are given for $V_{CC} = 5.0\text{V}$ and $T_A = 25^\circ\text{C}$.

Parameter Measurement Information

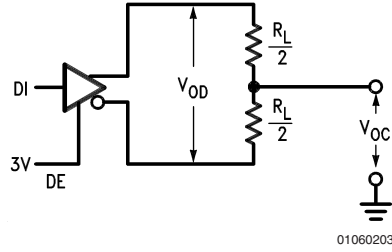

FIGURE 1. Driver V_{OD} and V_{OC}

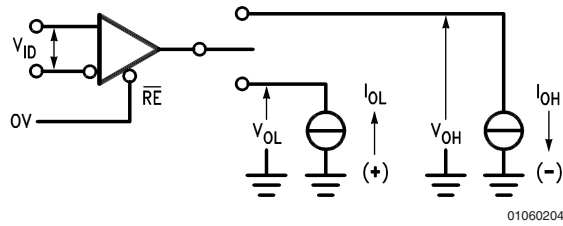

FIGURE 2. Receiver V_{OH} and V_{OL}

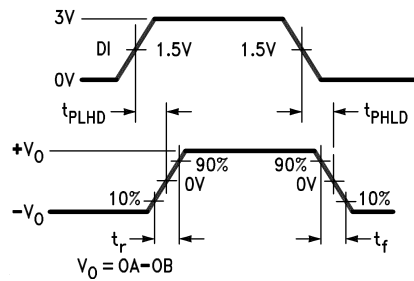
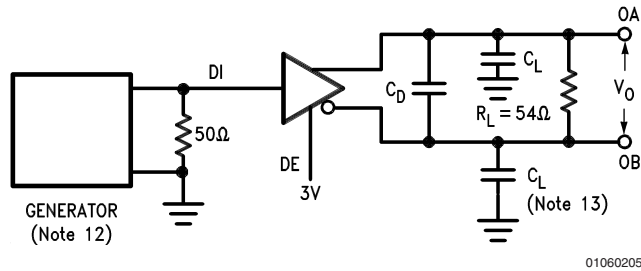
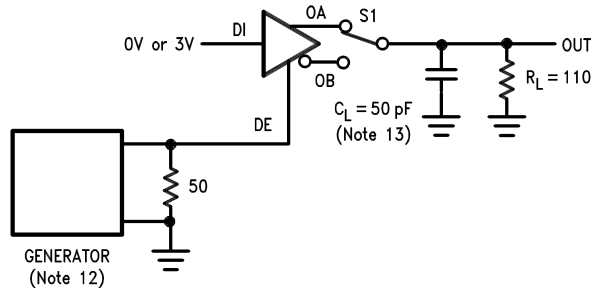

FIGURE 3. Driver Differential Propagation Delay and Transition Timing

Parameter Measurement Information (Continued)



01060209

S1 to OA for DI = 3V
S1 to OB for DI = 0V

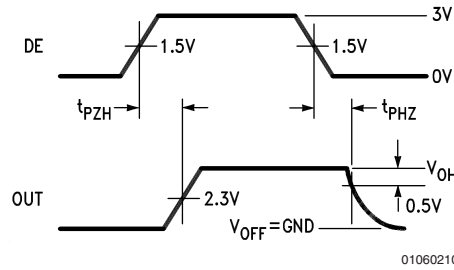

01060210

FIGURE 4. Driver Enable and Disable Timing (t_{PZH} , t_{PHZ})

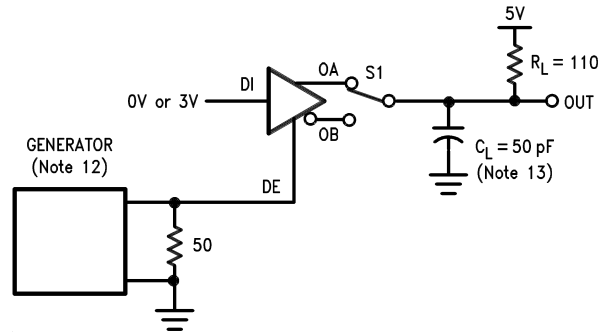

01060211

S1 to OA for DI = 0V
S1 to OB for DI = 3V

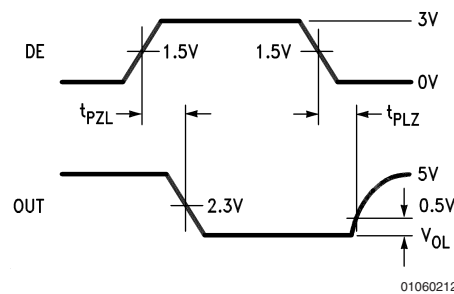

01060212

FIGURE 5. Driver Enable and Disable Timing (t_{PZL} , t_{PLZ})

Parameter Measurement Information (Continued)

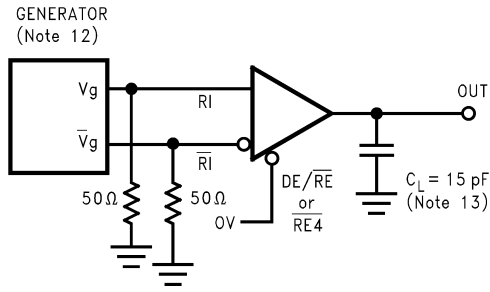

01060213

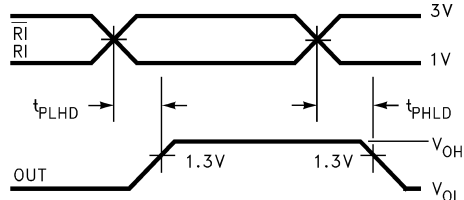

01060214

FIGURE 6. Receiver Differential Propagation Delay Timing

Parameter Measurement Information (Continued)

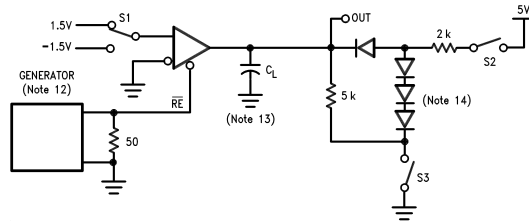

01060215

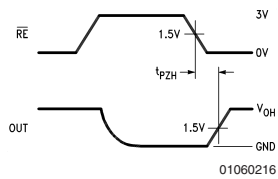

S1 1.5V
S2 OPEN
S3 CLOSED

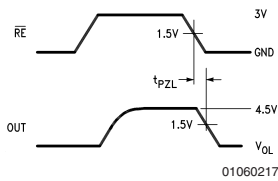

S1 -1.5V
S2 CLOSED
S3 OPEN

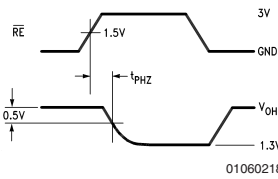

S1 1.5V
S2 CLOSED
S3 CLOSED

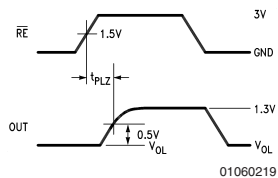

S1 -1.5V
S2 CLOSED
S3 CLOSED

FIGURE 7. Receiver Enable and Disable Timing

Parameter Measurement Information (Continued)

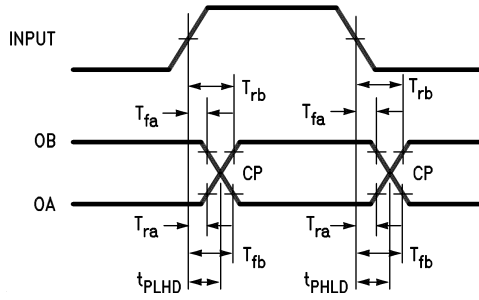

01060220

TCP = Crossing Point

Tra, Trb, Tfa, and Tfb are propagation delay measurements to the 20% and 80% levels.

$$TCP = \frac{(Tfb \times Trb) - (Tra \times Tfa)}{Trb - Tra - Tfa + Tfb}$$

FIGURE 8. Propagation Delay Timing for Calculation of Driver Differential Propagation Delays

Note 12: The input pulse is supplied by a generator having the following characteristics:

f = 1.0 MHz, 50% Duty Cycle, t_r and $t_f < 6.0$ ns, $Z_0 = 50\Omega$

Note 13: C_L includes probe and stray capacitance.

Note 14: Diodes are 1N916 or equivalent.

Note 15: Differential propagation delays are calculated from single-ended propagation delays measured from driver input to the 20% and 80% levels on the driver outputs (See Figure 8).

Typical Performance Characteristics

Driver Differential Propagation Delay vs Temperature

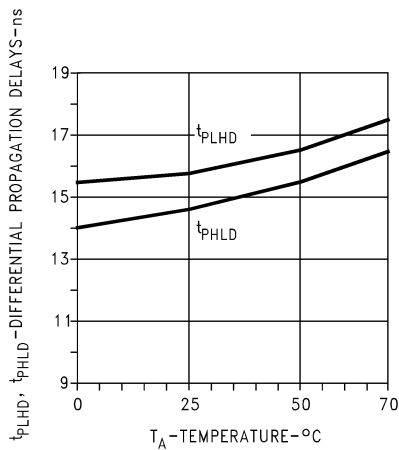

01060223

Driver Differential Propagation Delay vs VCC

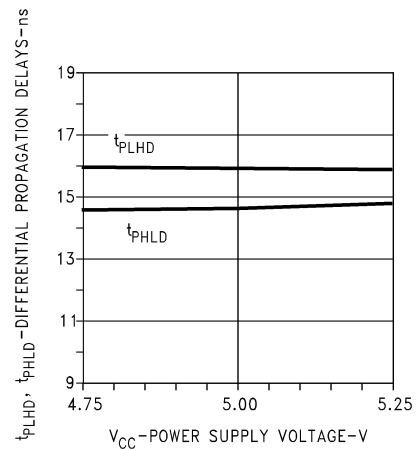

01060224

Typical Performance Characteristics (Continued)

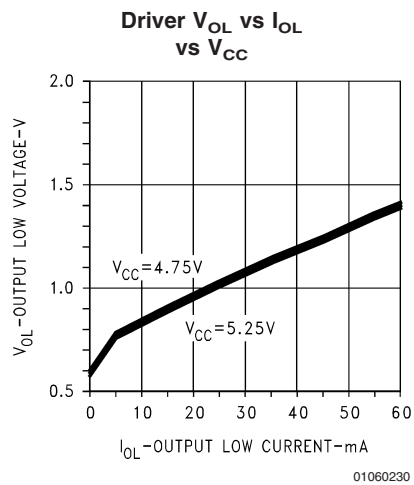
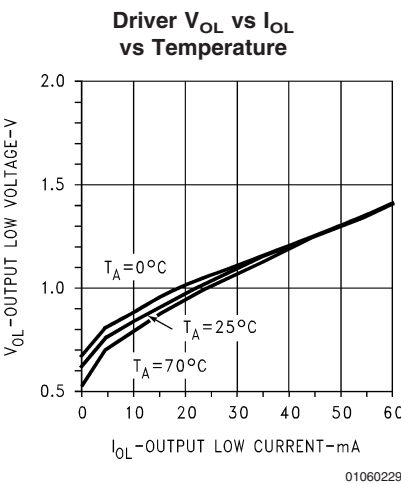
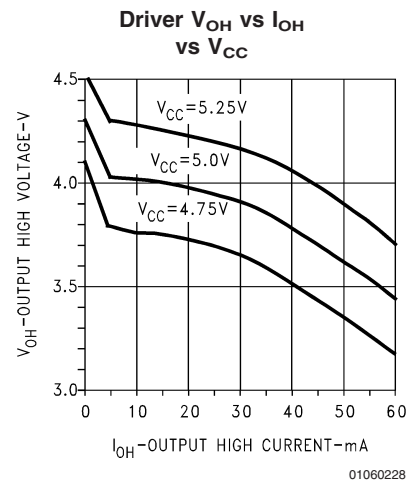
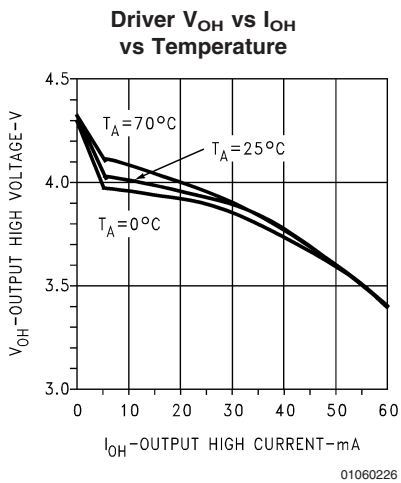
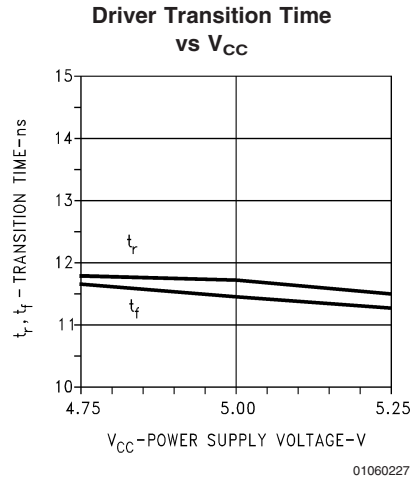
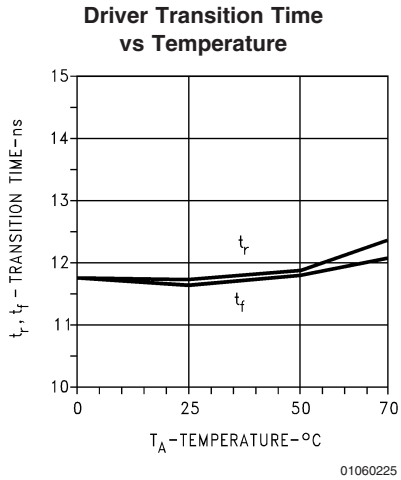

Typical Performance Characteristics (Continued)

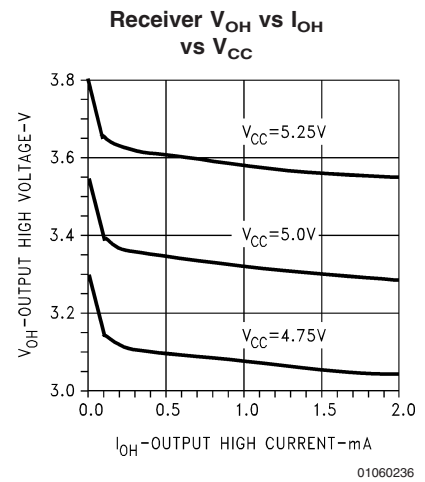
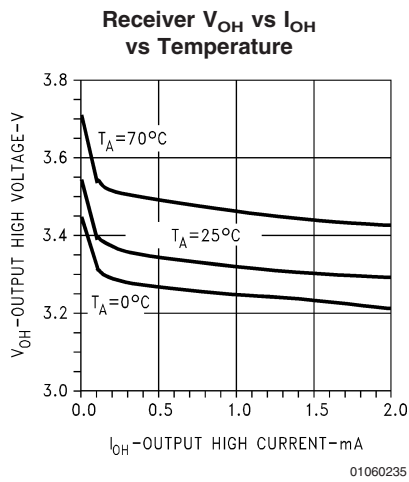
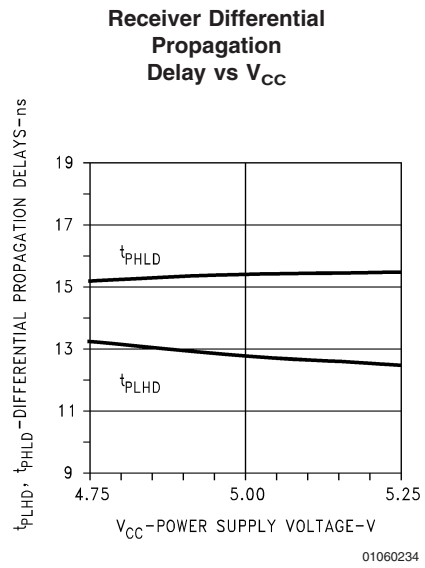
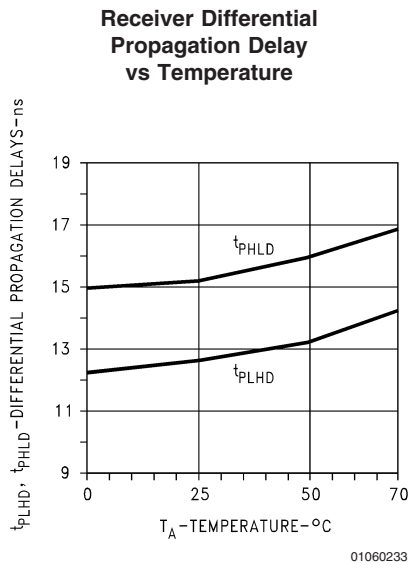
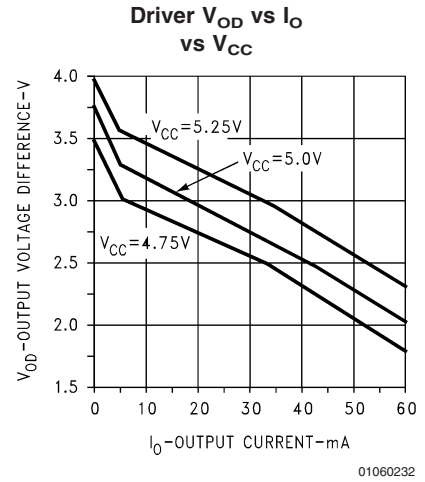
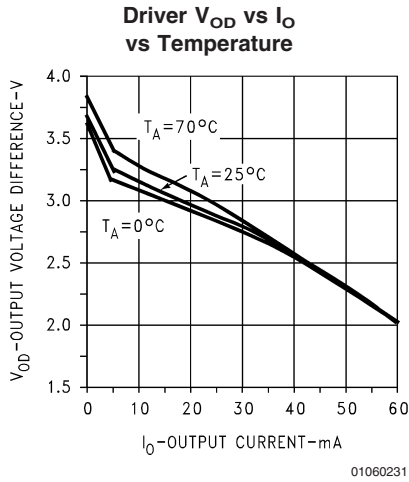

Typical Performance Characteristics (Continued)

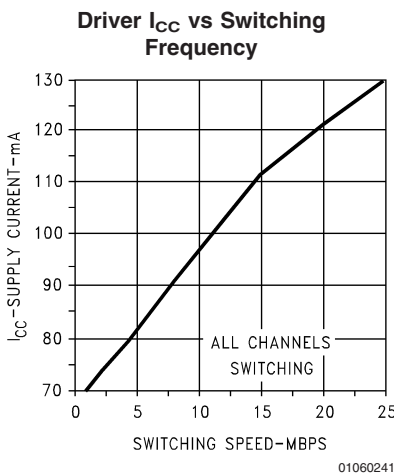
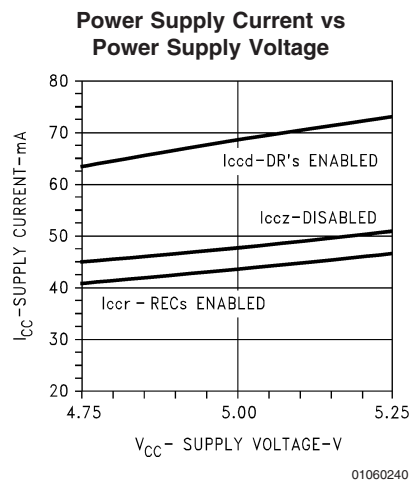
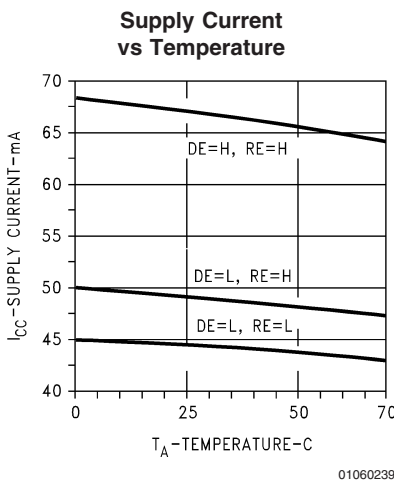
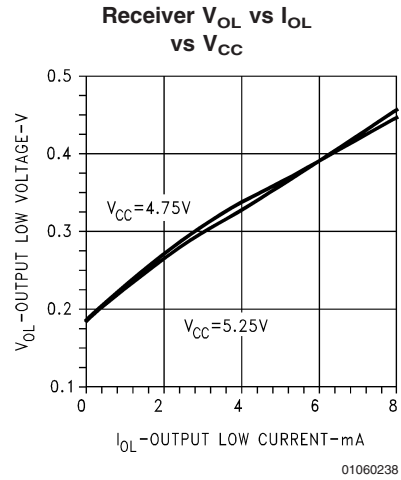
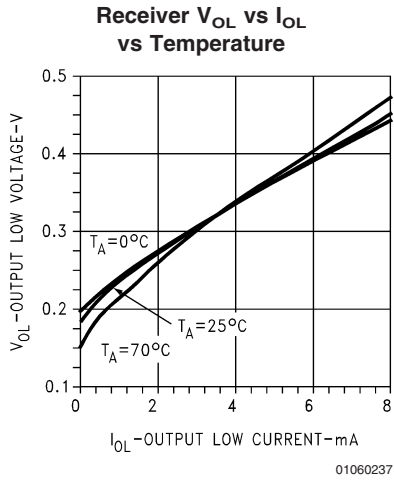

Physical Dimensions inches (millimeters) unless otherwise noted

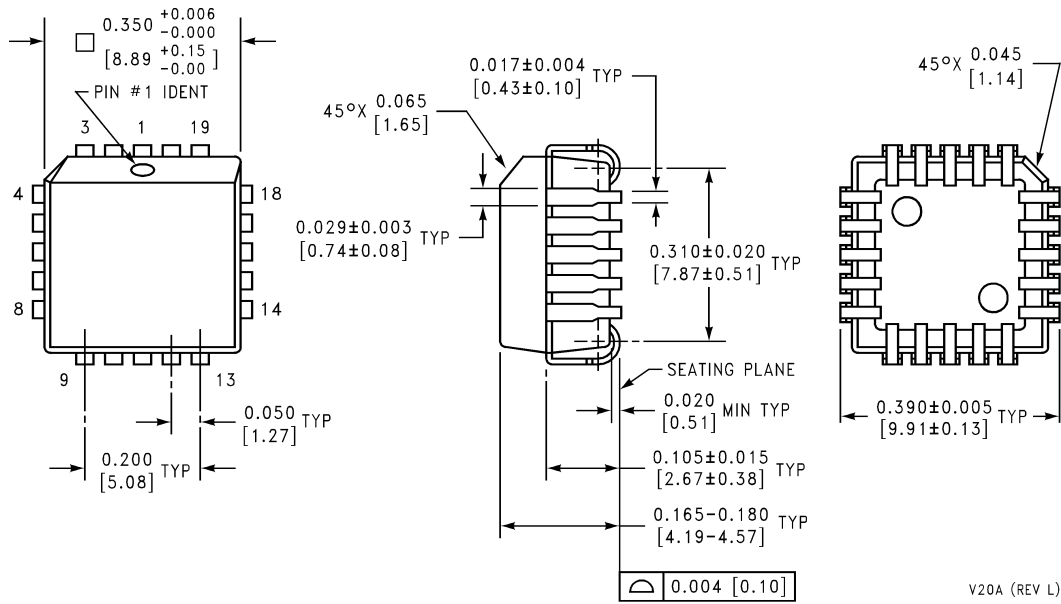

Order Number DS36950
NS Package Number V20A

V20A (REV L)

National does not assume any responsibility for use of any circuitry described, no circuit patent licenses are implied and National reserves the right at any time without notice to change said circuitry and specifications.

For the most current product information visit us at www.national.com.

LIFE SUPPORT POLICY

NATIONAL'S PRODUCTS ARE NOT AUTHORIZED FOR USE AS CRITICAL COMPONENTS IN LIFE SUPPORT DEVICES OR SYSTEMS WITHOUT THE EXPRESS WRITTEN APPROVAL OF THE PRESIDENT AND GENERAL COUNSEL OF NATIONAL SEMICONDUCTOR CORPORATION. As used herein:

1. Life support devices or systems are devices or systems which, (a) are intended for surgical implant into the body, or (b) support or sustain life, and whose failure to perform when properly used in accordance with instructions for use provided in the labeling, can be reasonably expected to result in a significant injury to the user.
2. A critical component is any component of a life support device or system whose failure to perform can be reasonably expected to cause the failure of the life support device or system, or to affect its safety or effectiveness.

BANNED SUBSTANCE COMPLIANCE

National Semiconductor certifies that the products and packing materials meet the provisions of the Customer Products Stewardship Specification (CSP-9-111C2) and the Banned Substances and Materials of Interest Specification (CSP-9-111S2) and contain no "Banned Substances" as defined in CSP-9-111S2.

 **National Semiconductor**
Americas Customer
Support Center
Email: new.feedback@nsc.com
Tel: 1-800-272-9959

National Semiconductor
Europe Customer Support Center
Fax: +49 (0) 180-530 85 86
Email: europe.support@nsc.com
Deutsch Tel: +49 (0) 69 9508 6208
English Tel: +44 (0) 870 24 0 2171
Français Tel: +33 (0) 1 41 91 8790

National Semiconductor
Asia Pacific Customer
Support Center
Email: ap.support@nsc.com

National Semiconductor
Japan Customer Support Center
Fax: 81-3-5639-7507
Email: jpn.feedback@nsc.com
Tel: 81-3-5639-7560

IMPORTANT NOTICE

Texas Instruments Incorporated and its subsidiaries (TI) reserve the right to make corrections, modifications, enhancements, improvements, and other changes to its products and services at any time and to discontinue any product or service without notice. Customers should obtain the latest relevant information before placing orders and should verify that such information is current and complete. All products are sold subject to TI's terms and conditions of sale supplied at the time of order acknowledgment.

TI warrants performance of its hardware products to the specifications applicable at the time of sale in accordance with TI's standard warranty. Testing and other quality control techniques are used to the extent TI deems necessary to support this warranty. Except where mandated by government requirements, testing of all parameters of each product is not necessarily performed.

TI assumes no liability for applications assistance or customer product design. Customers are responsible for their products and applications using TI components. To minimize the risks associated with customer products and applications, customers should provide adequate design and operating safeguards.

TI does not warrant or represent that any license, either express or implied, is granted under any TI patent right, copyright, mask work right, or other TI intellectual property right relating to any combination, machine, or process in which TI products or services are used. Information published by TI regarding third-party products or services does not constitute a license from TI to use such products or services or a warranty or endorsement thereof. Use of such information may require a license from a third party under the patents or other intellectual property of the third party, or a license from TI under the patents or other intellectual property of TI.

Reproduction of TI information in TI data books or data sheets is permissible only if reproduction is without alteration and is accompanied by all associated warranties, conditions, limitations, and notices. Reproduction of this information with alteration is an unfair and deceptive business practice. TI is not responsible or liable for such altered documentation. Information of third parties may be subject to additional restrictions.

Resale of TI products or services with statements different from or beyond the parameters stated by TI for that product or service voids all express and any implied warranties for the associated TI product or service and is an unfair and deceptive business practice. TI is not responsible or liable for any such statements.

TI products are not authorized for use in safety-critical applications (such as life support) where a failure of the TI product would reasonably be expected to cause severe personal injury or death, unless officers of the parties have executed an agreement specifically governing such use. Buyers represent that they have all necessary expertise in the safety and regulatory ramifications of their applications, and acknowledge and agree that they are solely responsible for all legal, regulatory and safety-related requirements concerning their products and any use of TI products in such safety-critical applications, notwithstanding any applications-related information or support that may be provided by TI. Further, Buyers must fully indemnify TI and its representatives against any damages arising out of the use of TI products in such safety-critical applications.

TI products are neither designed nor intended for use in military/aerospace applications or environments unless the TI products are specifically designated by TI as military-grade or "enhanced plastic." Only products designated by TI as military-grade meet military specifications. Buyers acknowledge and agree that any such use of TI products which TI has not designated as military-grade is solely at the Buyer's risk, and that they are solely responsible for compliance with all legal and regulatory requirements in connection with such use.

TI products are neither designed nor intended for use in automotive applications or environments unless the specific TI products are designated by TI as compliant with ISO/TS 16949 requirements. Buyers acknowledge and agree that, if they use any non-designated products in automotive applications, TI will not be responsible for any failure to meet such requirements.

Following are URLs where you can obtain information on other Texas Instruments products and application solutions:

Products

Audio	www.ti.com/audio
Amplifiers	amplifier.ti.com
Data Converters	dataconverter.ti.com
DLP® Products	www.dlp.com
DSP	dsp.ti.com
Clocks and Timers	www.ti.com/clocks
Interface	interface.ti.com
Logic	logic.ti.com
Power Mgmt	power.ti.com
Microcontrollers	microcontroller.ti.com
RFID	www.ti-rfid.com
OMAP Mobile Processors	www.ti.com/omap
Wireless Connectivity	www.ti.com/wirelessconnectivity

Applications

Communications and Telecom	www.ti.com/communications
Computers and Peripherals	www.ti.com/computers
Consumer Electronics	www.ti.com/consumer-apps
Energy and Lighting	www.ti.com/energy
Industrial	www.ti.com/industrial
Medical	www.ti.com/medical
Security	www.ti.com/security
Space, Avionics and Defense	www.ti.com/space-avionics-defense
Transportation and Automotive	www.ti.com/automotive
Video and Imaging	www.ti.com/video

TI E2E Community Home Page

e2e.ti.com

Mailing Address: Texas Instruments, Post Office Box 655303, Dallas, Texas 75265
Copyright © 2011, Texas Instruments Incorporated