

## PT4500 Series



20-W 24-V Input Isolated  
DC/DC Converter

SLTS153B - JUNE 2000 - REVISED OCTOBER 2002



### Features

- Input Voltage Range: 18V to 40V
- 20W Rated
- Output Voltages: 1.2V to 15V
- 82% Efficiency
- 1500 VDC Isolation
- Low Profile (8.5 mm)
- Adjustable Output Voltage
- On/Off Control
- Differential Remote Sense
- Short Circuit Protection
- Over Temperature Shutdown
- Space Saving Package: 1.0 sq. in. PCB Area (Suffix N)
- $4 \times 10^6$  Hrs MTBF

### Description

The PT4500 Excalibur™ power modules are a series of isolated DC/DC converters housed in a new space-saving copper case. The series includes a number of standard output voltages ranging from as low as 1.2VDC to 15VDC, each adjustable by up to 10% of nominal. The modules are ideal for Telecom, Industrial, Computer, and other distributed power applications that require input-to-output isolation.

Using multiple modules, system designers can implement a complete custom power supply solution. The flexibility of full isolation also allows the input or output to be configured for negative voltage operation.

The PT4500 series is electrically equivalent to the popular PT4140 series and requires no additional components for proper operation.

### Ordering Information

PT4501□	=	3.3V/5A (16.5W)
PT4502□	=	5.0V/4A
PT4503□	=	12V/1.6A
PT4504□	=	15V/1.3A
PT4506□	=	1.5V/5A (7.5W)
PT4507□	=	1.8V/5A (9W)
PT4508□	=	2.5V/5A (12.5W)
PT4509□	=	1.2V/5A (6W)

### PT Series Suffix (PT1234x)

Case/Pin Configuration	Order Suffix	Package Code
Vertical	<b>N</b>	(ELJ)
Horizontal	<b>A</b>	(ELK)
SMD	<b>C</b>	(ELL)

(Reference the applicable package code drawing for the dimensions and PC board layout)

### Pin-Out Information

Pin	Function
1	Remote On/Off *
2	-V <sub>IN</sub>
3	-V <sub>IN</sub>
4	+V <sub>IN</sub>
5	+V <sub>IN</sub>
6	Remote Sense (-)
7	-V <sub>OUT</sub>
8	-V <sub>OUT</sub>
9	+V <sub>OUT</sub>
10	+V <sub>OUT</sub>
11	Remote Sense (+)
12	V <sub>OUT</sub> Adjust *

\* For further information, see application notes.

### Standard Application

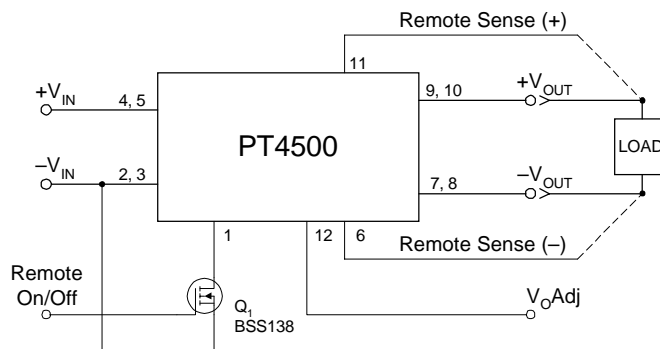

## PT4500 Series

20-W 24-V Input Isolated  
DC/DC Converter

SLTS153B - JUNE 2000 - REVISED OCTOBER 2002

Specifications (Unless otherwise stated,  $T_a = 25^\circ\text{C}$ ,  $V_{in} = 24\text{V}$ ,  $C_{out} = 0\mu\text{F}$ , and  $I_o = I_{o,max}$ )

Characteristic	Symbol	Conditions	PT4500 SERIES			Units	
			Min	Typ	Max		
Output Current	$I_o$	Over $V_{in}$ range	$V_o = 15\text{V}$	0.1 (1)	—	1.3	A
			$V_o = 12\text{V}$	0.1 (1)	—	1.6	
			$V_o = 5.0\text{V}$	0.1 (1)	—	4	
			$V_o \leq 3.3\text{V}$	0.1 (1)	—	5	
Input Voltage Range	$V_{in}$	Over $I_o$ Range	18	24	40	VDC	
Set Point Voltage Tolerance	$V_o$ tol		—	$\pm 1$	$\pm 1.5$ (2)	$\%V_o$	
Temperature Variation	$\text{Reg}_{temp}$	$-40^\circ \leq T_a \leq +85^\circ\text{C}$ , $I_o = I_{o,min}$	—	$\pm 0.5$	—	$\%V_o$	
Line Regulation	$\text{Reg}_{line}$	Over $V_{in}$ range	—	$\pm 0.2$	$\pm 1$	$\%V_o$	
Load Regulation	$\text{Reg}_{load}$	Over $I_o$ range	$V_o \geq 5.0\text{V}$	—	$\pm 0.4$	$\pm 1$ (2)	$\%V_o$
			$V_o \leq 3.3\text{V}$	—	$\pm 13$	$\pm 33$	mV
Total Output Voltage Variation	$\Delta V_{o,tot}$	Includes set-point, line, load, $-40^\circ \leq T_a \leq +85^\circ\text{C}$	—	$\pm 2$	$\pm 3$ (2)	$\%V_o$	
Efficiency	$\eta$		$V_o = 15\text{V}$	—	86	—	%
			$V_o = 12\text{V}$	—	83	—	
			$V_o = 5.0\text{V}$	—	82	—	
			$V_o = 3.3\text{V}$	—	79	—	
			$V_o = 1.8\text{V}$	—	67	—	
			$V_o = 1.5\text{V}$	—	65	—	
$V_o$ Ripple (pk-pk)	$V_r$	20MHz bandwidth	$V_o \geq 5.0\text{V}$	—	0.5	—	$\%V_o$
			$V_o \leq 3.3\text{V}$	—	15	—	mV <sub>pp</sub>
Transient Response	$t_{tr}$	0.1A/ $\mu\text{s}$ load step, 50% to 100% $I_{o,max}$	—	100	—	$\mu\text{s}$	
		$V_o$ over/undershoot	$V_o \geq 5.0\text{V}$	—	$\pm 3$	—	$\%V_o$
	$\Delta V_{tr}$		$V_o \leq 3.3\text{V}$	—	$\pm 150$	—	mV
Current Limit Threshold	$I_{lim}$	$V_{in} = 18\text{V}$ , $\Delta V_o = -1\%$	—	200	—	$\%I_{o,max}$	
Output Voltage Adjust	$V_o$ adj		—	$\pm 10$	—	%	
Switching Frequency	$f_s$	Over $V_{in}$ range	$V_o \geq 5.0\text{V}$	600	650	700	kHz
			$V_o \leq 3.3\text{V}$	800	850	900	
Under-Voltage Lockout	UVLO		—	16.5	—	V	
Remote On/Off (Pin 1)		Referenced to $-V_{in}$ (pin 2)					
High-Level Input Voltage	$V_{IH}$		2.5	—	Open (3)	V	
Low-Level Input Voltage	$V_{IL}$		-0.2	—	0.8		
Low-Level Input Current	$I_{IL}$		—	-10	—	$\mu\text{A}$	
Standby Input Current	$I_{in, standby}$	pins 1 & 2 connected	—	7	10	mA	
Internal Input Capacitance	$C_{in}$		—	0.5	—	$\mu\text{F}$	
External Output Capacitance	$C_{out}$		0	—	220 (4)	$\mu\text{F}$	
Isolation Voltage	Capacitance	Input-output/input-case	1500	—	—	V	
		Input to output	—	1100	—	pF	
		Input to output	10	—	—	M $\Omega$	
Resistance							
Operating Temperature Range	$T_a$	Over $V_{in}$ range	-40	—	85 (5)	$^\circ\text{C}$	
Solder Reflow Temperature	$T_{reflow}$	Surface temperature of module pins or case	—	—	215 (6)	$^\circ\text{C}$	
Storage Temperature	$T_s$	—	-40	—	125	$^\circ\text{C}$	
Reliability	MTBF	Per Bellcore TR-332 50% stress, $T_a = 40^\circ\text{C}$ , ground benign	4	—	—	$10^6$ Hrs	
Mechanical Shock	—	Per Mil-Std-883D, method 2002.3, 1mS, half-sine, mounted to a fixture	—	500	—	G's	
Mechanical Vibration	—	Mil-Std-883D, Method 2007.2 20-2000Hz, soldered	Suffix N	—	20 (7)	—	G's
			Suffix A, C	—	20 (7)	—	
Weight	—	—	—	23	—	grams	
Flammability	—	Materials meet UL 94V-0	—	—	—	—	

- Notes:**
- (1) The DC/DC converter will operate at no load with reduced specifications.
  - (2) For optimum voltage accuracy the 'Remote Sense (+)' and 'Remote Sense (-)' pins must be connected to  $+V_{out}$  and  $-V_{out}$  respectively.
  - (3) The Remote On/Off control (pin 1) has an internal pull-up. If pin 1 is left open the PT4500 will operate when input power is applied. A small low-leakage ( $<100\text{nA}$ ) MOSFET must be used to control this input. The open-circuit voltage is less than 10V. See application notes for further information.
  - (4) External output capacitance is not required for proper operation. Capacitance may be added to improve the response to load transients. The maximum total capacitance (including the load circuit) must not exceed 220 $\mu\text{F}$ , and the combined ESR of must not be less than 100m $\Omega$ .
  - (5) See Safe Operating Area curves or contact the factory for the appropriate derating.
  - (6) During solder reflow of SMD package version do not elevate the module case, pins, or internal component temperatures above a peak of 215 $^\circ\text{C}$ . For further guidance refer to the application note, "Reflow Soldering Requirements for Plug-in Power Surface Mount Products," (SLTA051).
  - (7) The case pins on the through-hole package types (suffixes N & A) must be soldered. For more information see the applicable package outline drawing.

PT4500 Series

Typical Characteristics

20-W 24-V Input Isolated DC/DC Converter

SLTS153B - JUNE 2000 - REVISED OCTOBER 2002

PT4501, 3.3 VDC (See Note A)

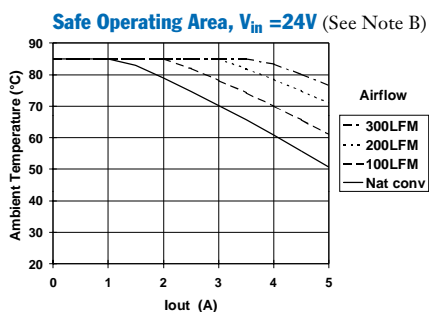
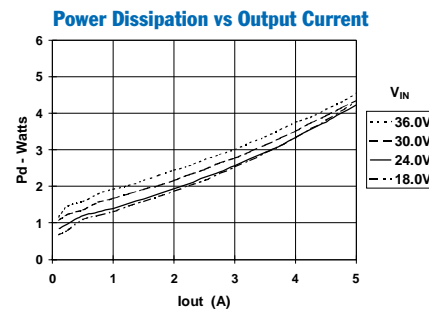
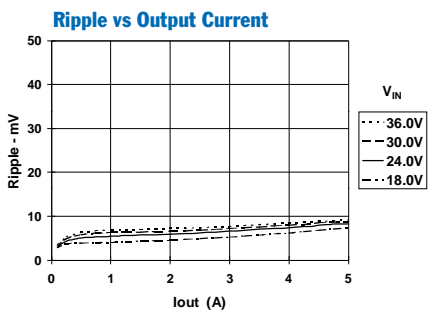
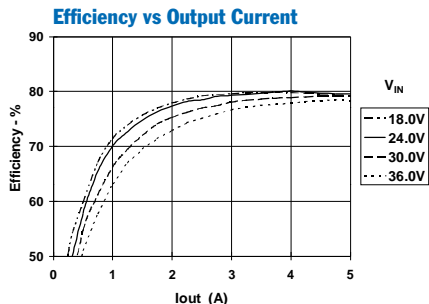

PT4502, 5 VDC (See Note A)

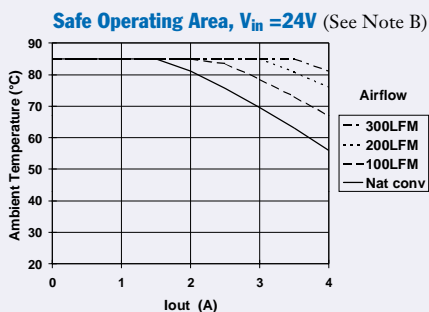
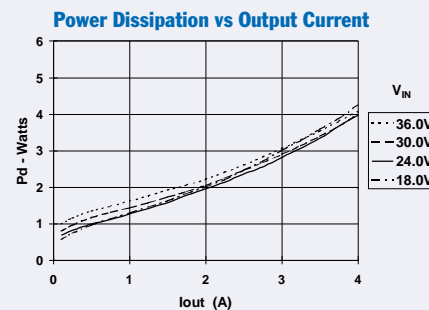
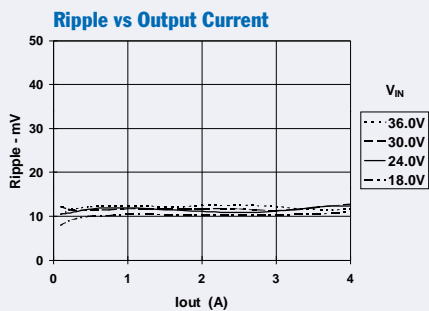
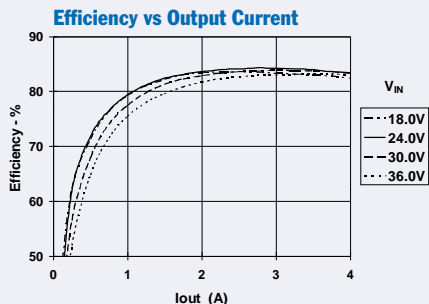

PT4503, 12 VDC (See Note A)

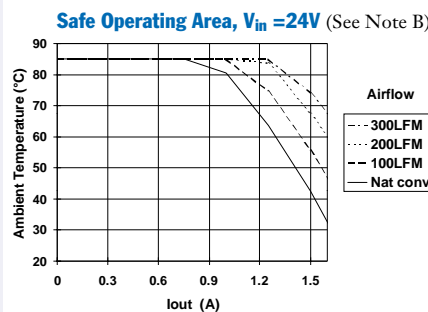
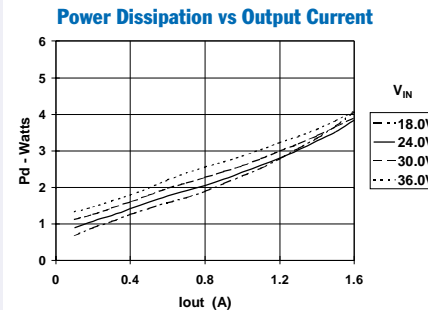
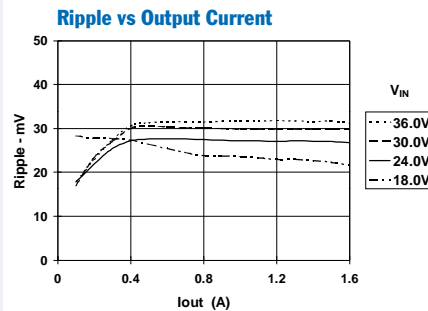
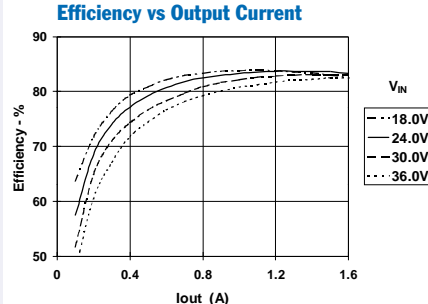

Note A: Characteristic data has been developed from actual products tested at 25°C. This data is considered typical data for the Converter.  
 Note B: SOA curves represent the conditions at which internal components are at or below the manufacturer's maximum operating temperatures

## Operating Features and System Considerations for the PT4500/PT4520 DC/DC Converters

### Output Current Limit

The PT4500 and PT4520 series of DC/DC converters incorporate an output current limit. This protects both the module and upstream source against load faults. Applying a load, in excess of the current limit threshold, will simply cause the output voltage to drop. The output current remains limited, but continues to flow in the fault. The drop in output voltage will vary according to the severity of the fault. Applying a short circuit to the output will result in an output voltage of zero, and the fault current will be limited to a value slightly higher than the current limit threshold. Upon the removal of the load fault, the output voltage of the module will fully recover to its normal regulated output voltage.

### Primary-Secondary Isolation

The PT4500 and PT4520 series of DC/DC converters incorporate electrical isolation between the input terminals (primary) and the output terminals (secondary). All converters are production tested to a withstand voltage of 1500VDC. The isolation complies with UL60950 and EN60950, and the requirements for operational isolation. This allows the converter to be configured for either a positive or negative input voltage source.

### Output Voltage Adjustment

The output voltage is typically adjustable over a range of  $\pm 10\%$  of nominal. Consult the separate application note, "Adjusting the Output Voltage of the PT4500/PT4520 Series of Isolated DC/DC Converters."

### Remote On/Off Function

The output voltage from the converter can be turned off from the primary side using the *Remote On/Off* control (pin 1). Consult the separate application note, "Using the Remote On/Off Function on the PT4500/PT4520 Series of Isolated DC/DC Converters."

### Under-Voltage Lock-Out

The Under-Voltage Lock-Out (UVLO) circuit prevents operation of the converter whenever the input voltage to the module is insufficient to maintain output regulation. Below the UVLO threshold the module is off and the *Remote On/Off* control (pin 1) is inoperative. Table 1-2 gives the applicable UVLO thresholds.

**Table 1-2; UVLO Thresholds**

Series	UVLO Threshold	V <sub>in</sub> Range
PT4520	31V Typical	36 – 75V
PT4500	16.5V Typical	18 – 40V

### Turn-On Time

The typical turn-on time is typically 35 milliseconds at V<sub>in</sub> = 48V. This is from application of input power, or the removal of a low-voltage signal from the *Remote On/Off* (pin 1). This includes about 5–10ms of delay time before the output voltage begins to rise. Turn-on time will vary slightly with input voltage, output load, and the total amount of capacitance connected to the output.

### Input Current Limiting

**The converter is not internally fused.** For safety and overall system protection, the maximum input current to the converter must be limited. Active or passive current limiting can be used. Passive current limiting can be a fast acting fuse. A 125-V fuse, rated no more than 5A, is recommended. Active current limiting can be implemented with a current limited "Hot-Swap" controller.

### Thermal Considerations

Airflow may be necessary to ensure that the module can supply the desired load current in environments with elevated ambient temperatures. The required airflow rate may be determined from the Safe Operating Area (SOA) thermal derating curves. These are provided in the "Typical Characteristics" section of the converter specifications.

## Application Notes

## PT4500/4520 Series

## Adjusting the Output Voltage of the PT4500/PT4520 Series of Isolated DC/DC Converters

The factory pre-set output voltage of TI's PT4500 and PT4520 series of isolated DC/DC converters may be adjusted within a nominal  $\pm 10\%$  range. Adjustment is made from the secondary side of the regulator<sup>1</sup> with a single external resistor. For the input voltage range specified in the data sheet Table 2-1 gives the allowable adjustment range for each model, as  $V_o$  (min) and  $V_o$  (max).

**Adjust Up:** An increase in the output voltage is obtained by adding a resistor,  $R_2$  between  $V_o$  Adjust (pin 12), and  $-V_{out}$  (pin 7, 8).

**Adjust Down:** Add a resistor ( $R_1$ ), between  $V_o$  Adjust (pin 12), and  $+V_{out}$  (pin 9, 10).

Refer to Figure 2-1 and Table 2-2 for both the placement and value of the required resistor, ( $R_1$ ) or  $R_2$ .

**Notes:**

1. The PT4500 and PT4520 series of DC/DC converters incorporate isolation between the  $\pm V_{in}$  and  $\pm V_o$  terminals. Adjustment of the output voltage is made to the regulation circuit on the secondary or output side of the converter.
2. The maximum rated output power for this series is 20W. An increase in the output voltage may therefore require a corresponding reduction in the maximum output current (see Table 2-1). The revised maximum output current must be determined as follows.

$$I_o(\max) = \frac{20}{V_a} \text{ A, or } 5\text{A, whichever is less.}$$

Where  $V_a$  is the adjusted output voltage.

3. Use only a single 1% resistor in either the ( $R_1$ ) or  $R_2$  location. Place the resistor as close to the module as possible.

4. Never connect capacitors to  $V_o$  adjust. Any capacitance added to the  $V_o$  adjust control pin will affect the stability of the converter.

The values of ( $R_1$ ) [adjust down], and  $R_2$  [adjust up], can also be calculated using the following formulas.

$$(R_1) = \frac{K_o(V_a - V_r)}{V_r(V_o - V_a)} - R_s \quad \text{k}\Omega$$

$$R_2 = \frac{K_o}{(V_a - V_o)} - R_s \quad \text{k}\Omega$$

Where  $V_o$  = Original output voltage  
 $V_a$  = Adjusted output voltage  
 $V_r$  = Reference voltage (Table 2-1)  
 $K_o$  = Multiplier constant (Table 2-1)  
 $R_s$  = Internal series resistance (Table 2-1)

Figure 2-1

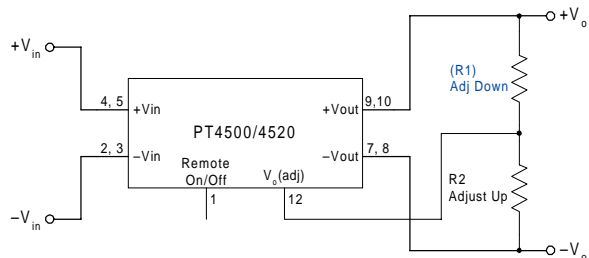

Table 2-1

## DC/DC CONVERTER ADJUSTMENT RANGE AND FORMULA PARAMETERS

Series Pt #	PT4529	PT4526	PT4527	PT4528	PT4521	PT4522	PT4523	PT4524
48V Bus								
24V Bus	PT4509	PT4506	PT4507	PT4508	PT4501	PT4502	PT4503	PT4504
Max Current <sup>2</sup>	5A	5A	5A	5A	5A	4A	1.6A	1.3A
$V_o$ (nom)	1.2	1.5	1.8	2.5	3.3	5.0	12.0	15.0
$V_a$ (min)	1.05	1.35	1.62	2.25	2.95	4.5	10.8	13.5
$V_a$ (max)	1.35	1.65	1.98	2.75	3.65	5.5	13.2	16.5
$V_r$	0.6125	1.225	1.225	1.225	1.225	2.5	2.5	2.5
$K_o$ (V·k $\Omega$ )	34.66	67.07	69.7	64.2	69.3	125.2	139.8	137.6
$R_s$ (k $\Omega$ )	150.0	43.2	110.0	187.0	187.0	187.0	110.0	90.9

## PT4500/4520 Series

Table 2-2

## DC/DC CONVERTER SERIES ADJUSTMENT RESISTOR VALUES

Series Pt #									
48V Bus	PT4529	PT4526	PT4527	PT4528	PT4521	PT4522	PT4523	PT4524	
24V Bus	PT4509	PT4506	PT4507	PT4508	PT4501	PT4502	PT4503	PT4504	
V <sub>o</sub> (nom)	1.2Vdc	1.5Vdc	1.8Vdc	2.5Vdc	3.3Vdc	5.0Vdc	12.0Vdc	15.0Vdc	
V <sub>a</sub> (req'd)						V <sub>a</sub> (req'd)	V <sub>a</sub> (req'd)		
1.05	(15.1)kΩ					4.5	(12.6)kΩ	10.8	(276.0)kΩ
1.1	(126.0)kΩ					4.55	(40.3)kΩ	11.0	(365.0)kΩ
1.15	(458.0)kΩ					4.6	(75.0)kΩ	11.2	(497.0)kΩ
1.2						4.65	(120.0)kΩ	11.4	(719.0)kΩ
1.25	543.0kΩ					4.7	(179.0)kΩ	11.6	(1.16)MΩ
1.3	197.0kΩ					4.75	(262.0)kΩ	11.8	
1.35	81.1kΩ	(2.8)kΩ				4.8	(387.0)kΩ	12.0	
1.4		(53.2)kΩ				4.85	(595.0)kΩ	12.2	588.0kΩ
1.45		(204.0)kΩ				4.9	(1.01)MΩ	12.4	239.0kΩ
1.5						4.95		12.6	123.0kΩ
1.55		1.3MΩ				5.0		12.8	64.6kΩ
1.6		627.0kΩ				5.05		13.0	29.7kΩ
1.65		404.0kΩ	(51.7)kΩ			5.1	1.06MΩ	13.2	6.4kΩ
1.7			(161.0)kΩ			5.15	645.0kΩ	13.5	(312.0)kΩ
1.75			(489.0)kΩ			5.2	437.0kΩ	13.6	(345.0)kΩ
1.8						5.25	312.0kΩ	13.8	(427.0)kΩ
1.85			1.28MΩ			5.3	229.0kΩ	14.0	(542.0)kΩ
1.9			587.0kΩ			5.35	169.0kΩ	14.2	(713.0)kΩ
1.95			355.0kΩ			5.4	125.0kΩ	14.4	(1.0)MΩ
2.25				(26.5)kΩ		5.45	90.2kΩ	14.6	(1.57)MΩ
2.3				(92.9)kΩ		5.5	62.4kΩ	14.8	
2.35				(203.0)kΩ				15.0	
2.4				(425.0)kΩ				15.2	597.0kΩ
2.45				(1.09)MΩ				15.4	253.0kΩ
2.5								15.6	138.0kΩ
2.55				1.09MΩ				15.8	81.0kΩ
2.6				450.0kΩ				16.0	46.6kΩ
2.65				237.0kΩ				16.5	0.8kΩ
2.7				131.0kΩ					
2.75				67.7kΩ					
2.95					(90.7)kΩ				
3.0					(146.0)kΩ				
3.05					(224.0)kΩ				
3.1					(341.0)kΩ				
3.15					(536.0)kΩ				
3.2					(926.0)kΩ				
3.25					(2.09)MΩ				
3.3									
3.35					1.19MΩ				
3.4					502.0kΩ				
3.45					272.0kΩ				
3.5					158.0kΩ				
3.55					88.7kΩ				
3.6					42.7kΩ				
3.65					9.9kΩ				

R1 = (Blue)    R2 = Black

## Application Notes

## PT4500/4520 Series

## Using the Remote On/Off Function on the PT4500/PT4520 Series of Isolated DC/DC Converters

For applications requiring output voltage on/off control, the PT4500/4520 series of DC/DC converters incorporate a remote on/off function. This function may be used in applications that require battery conservation, power-up/shutdown sequencing, and/or to coordinate the power-up of the regulator for active in-rush current control. (See the related application note, SLTA021).

This function is provided by the *Remote On/Off* control, pin 1. If pin 1 is left open-circuit, the converter provides a regulated output whenever a valid source voltage<sup>3</sup> is applied between  $+V_{in}$  (pin 4, 5), and  $-V_{in}$  (pin 2, 3). Connecting pin 1 to pin 2, or applying a low-level signal to pin 1 (with respect to  $-V_{in}$ ),<sup>1</sup> will disable the regulator output<sup>5</sup>.

Table 3-1 provides details of the interface requirements for the *Remote On/Off* pin. Figure 3-1 shows how a discrete MOSFET (Q<sub>1</sub>), may be referenced to the negative input rail and used with this control input.

**Table 3-1 Inhibit Control Requirements**<sup>1</sup>

Parameter	Min	Max
Enable (V <sub>IH</sub> )	2.5V	(Open Circuit) <sup>4</sup>
Disable (V <sub>IL</sub> )	-0.3V	0.8V

**Notes:**

- The on/off control uses  $-V_{in}$  (pin 1), on the primary side of the converter, as its ground reference. All voltages specified are with respect to  $-V_{in}$ .
- The on/off control internal circuitry is a high impedance 10 $\mu$ A current source. The open-circuit voltage may be as high as 8.3Vdc.
- The PT4500/20 series incorporates an “Under-Voltage Lockout” (UVLO) function. The UVLO prevents operation of the converter when there is sufficient input voltage to support a regulated output. Below the UVLO threshold voltage, there is no output from the module and the Remote On/Off control is inoperative.
- The *Remote On/Off* input of the PT4500/20 series must be controlled with a low-leakage (<100nA) open-drain MOSFET. *Do not* use a pull-up resistor.
- When the converter output is disabled, the current drawn from the input supply is typically reduced to 8mA (16mA maximum).
- Keep the on/off transition to less than 1ms. This prevents erratic operation of the ISR, whereby the output voltage may drift un-regulated between 0V and the rated output during power-up.

**Figure 3-1**

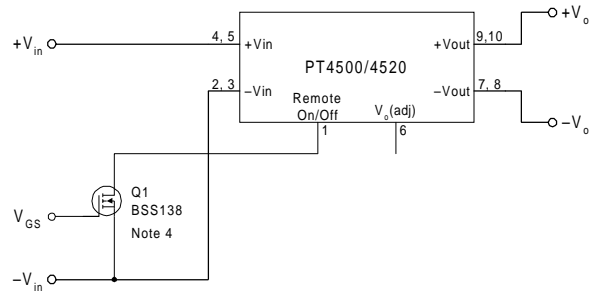

**Turn-On Time:** The converter typically produces a fully regulated output voltage within 35ms after the removal of the low voltage signal from the *Remote On/Off* pin. Using the circuit of Figure 3-1, Figure 3-2 shows the output voltage and input current waveforms of a PT4521 after Q<sub>1</sub> is turned off. The turn off of Q<sub>1</sub> corresponds to the drop in Q<sub>1</sub> V<sub>gs</sub> voltage. The waveforms were measured with a 48Vdc input voltage, and 2.75-A resistive load.

**Figure 3-2**

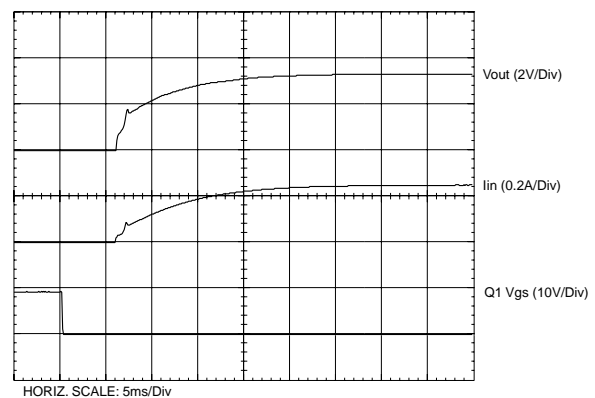

**PACKAGING INFORMATION**

Orderable Device	Status <sup>(1)</sup>	Package Type	Package Drawing	Pins	Package Qty	Eco Plan <sup>(2)</sup>	Lead/ Ball Finish	MSL Peak Temp <sup>(3)</sup>	Samples (Requires Login)
PT4501A	NRND	SIP MODULE	ELK	12	10	Pb-Free (RoHS)	Call TI	N / A for Pkg Type	
PT4501N	NRND	SIP MODULE	ELJ	12	10	Pb-Free (RoHS)	Call TI	N / A for Pkg Type	
PT4502A	NRND	SIP MODULE	ELK	12	10	Pb-Free (RoHS)	Call TI	N / A for Pkg Type	
PT4502C	NRND	SIP MODULE	ELL	12	10	Pb-Free (RoHS)	Call TI	Level-3-215C-168HRS	
PT4502N	NRND	SIP MODULE	ELJ	12	10	Pb-Free (RoHS)	Call TI	N / A for Pkg Type	
PT4503A	NRND	SIP MODULE	ELK	12	10	Pb-Free (RoHS)	Call TI	N / A for Pkg Type	
PT4503N	NRND	SIP MODULE	ELJ	12	10	Pb-Free (RoHS)	Call TI	N / A for Pkg Type	
PT4504A	NRND	SIP MODULE	ELK	12	10	Pb-Free (RoHS)	Call TI	N / A for Pkg Type	
PT4504N	NRND	SIP MODULE	ELJ	12	10	Pb-Free (RoHS)	Call TI	N / A for Pkg Type	
PT4506A	NRND	SIP MODULE	ELK	12	10	Pb-Free (RoHS)	Call TI	N / A for Pkg Type	
PT4507A	NRND	SIP MODULE	ELK	12	10	Pb-Free (RoHS)	Call TI	N / A for Pkg Type	
PT4508A	NRND	SIP MODULE	ELK	12	10	Pb-Free (RoHS)	Call TI	N / A for Pkg Type	
PT4508C	NRND	SIP MODULE	ELL	12	10	Pb-Free (RoHS)	Call TI	Level-3-215C-168HRS	
PT4508N	NRND	SIP MODULE	ELJ	12	10	Pb-Free (RoHS)	Call TI	N / A for Pkg Type	
PT4509A	NRND	SIP MODULE	ELK	12	10	Pb-Free (RoHS)	Call TI	N / A for Pkg Type	

<sup>(1)</sup> The marketing status values are defined as follows:

**ACTIVE:** Product device recommended for new designs.

**LIFEBUY:** TI has announced that the device will be discontinued, and a lifetime-buy period is in effect.

**NRND:** Not recommended for new designs. Device is in production to support existing customers, but TI does not recommend using this part in a new design.

**PREVIEW:** Device has been announced but is not in production. Samples may or may not be available.

**OBSOLETE:** TI has discontinued the production of the device.

<sup>(2)</sup> Eco Plan - The planned eco-friendly classification: Pb-Free (RoHS), Pb-Free (RoHS Exempt), or Green (RoHS & no Sb/Br) - please check <http://www.ti.com/productcontent> for the latest availability information and additional product content details.

**TBD:** The Pb-Free/Green conversion plan has not been defined.

**Pb-Free (RoHS):** TI's terms "Lead-Free" or "Pb-Free" mean semiconductor products that are compatible with the current RoHS requirements for all 6 substances, including the requirement that lead not exceed 0.1% by weight in homogeneous materials. Where designed to be soldered at high temperatures, TI Pb-Free products are suitable for use in specified lead-free processes.

**Pb-Free (RoHS Exempt):** This component has a RoHS exemption for either 1) lead-based flip-chip solder bumps used between the die and package, or 2) lead-based die adhesive used between the die and leadframe. The component is otherwise considered Pb-Free (RoHS compatible) as defined above.

**Green (RoHS & no Sb/Br):** TI defines "Green" to mean Pb-Free (RoHS compatible), and free of Bromine (Br) and Antimony (Sb) based flame retardants (Br or Sb do not exceed 0.1% by weight in homogeneous material)

<sup>(3)</sup> MSL, Peak Temp. -- The Moisture Sensitivity Level rating according to the JEDEC industry standard classifications, and peak solder temperature.

**Important Information and Disclaimer:** The information provided on this page represents TI's knowledge and belief as of the date that it is provided. TI bases its knowledge and belief on information provided by third parties, and makes no representation or warranty as to the accuracy of such information. Efforts are underway to better integrate information from third parties. TI has taken and continues to take reasonable steps to provide representative and accurate information but may not have conducted destructive testing or chemical analysis on incoming materials and chemicals. TI and TI suppliers consider certain information to be proprietary, and thus CAS numbers and other limited information may not be available for release.

In no event shall TI's liability arising out of such information exceed the total purchase price of the TI part(s) at issue in this document sold by TI to Customer on an annual basis.

## IMPORTANT NOTICE

Texas Instruments Incorporated and its subsidiaries (TI) reserve the right to make corrections, modifications, enhancements, improvements, and other changes to its products and services at any time and to discontinue any product or service without notice. Customers should obtain the latest relevant information before placing orders and should verify that such information is current and complete. All products are sold subject to TI's terms and conditions of sale supplied at the time of order acknowledgment.

TI warrants performance of its hardware products to the specifications applicable at the time of sale in accordance with TI's standard warranty. Testing and other quality control techniques are used to the extent TI deems necessary to support this warranty. Except where mandated by government requirements, testing of all parameters of each product is not necessarily performed.

TI assumes no liability for applications assistance or customer product design. Customers are responsible for their products and applications using TI components. To minimize the risks associated with customer products and applications, customers should provide adequate design and operating safeguards.

TI does not warrant or represent that any license, either express or implied, is granted under any TI patent right, copyright, mask work right, or other TI intellectual property right relating to any combination, machine, or process in which TI products or services are used. Information published by TI regarding third-party products or services does not constitute a license from TI to use such products or services or a warranty or endorsement thereof. Use of such information may require a license from a third party under the patents or other intellectual property of the third party, or a license from TI under the patents or other intellectual property of TI.

Reproduction of TI information in TI data books or data sheets is permissible only if reproduction is without alteration and is accompanied by all associated warranties, conditions, limitations, and notices. Reproduction of this information with alteration is an unfair and deceptive business practice. TI is not responsible or liable for such altered documentation. Information of third parties may be subject to additional restrictions.

Resale of TI products or services with statements different from or beyond the parameters stated by TI for that product or service voids all express and any implied warranties for the associated TI product or service and is an unfair and deceptive business practice. TI is not responsible or liable for any such statements.

TI products are not authorized for use in safety-critical applications (such as life support) where a failure of the TI product would reasonably be expected to cause severe personal injury or death, unless officers of the parties have executed an agreement specifically governing such use. Buyers represent that they have all necessary expertise in the safety and regulatory ramifications of their applications, and acknowledge and agree that they are solely responsible for all legal, regulatory and safety-related requirements concerning their products and any use of TI products in such safety-critical applications, notwithstanding any applications-related information or support that may be provided by TI. Further, Buyers must fully indemnify TI and its representatives against any damages arising out of the use of TI products in such safety-critical applications.

TI products are neither designed nor intended for use in military/aerospace applications or environments unless the TI products are specifically designated by TI as military-grade or "enhanced plastic." Only products designated by TI as military-grade meet military specifications. Buyers acknowledge and agree that any such use of TI products which TI has not designated as military-grade is solely at the Buyer's risk, and that they are solely responsible for compliance with all legal and regulatory requirements in connection with such use.

TI products are neither designed nor intended for use in automotive applications or environments unless the specific TI products are designated by TI as compliant with ISO/TS 16949 requirements. Buyers acknowledge and agree that, if they use any non-designated products in automotive applications, TI will not be responsible for any failure to meet such requirements.

Following are URLs where you can obtain information on other Texas Instruments products and application solutions:

### Products

Audio	<a href="http://www.ti.com/audio">www.ti.com/audio</a>
Amplifiers	<a href="http://amplifier.ti.com">amplifier.ti.com</a>
Data Converters	<a href="http://dataconverter.ti.com">dataconverter.ti.com</a>
DLP® Products	<a href="http://www.dlp.com">www.dlp.com</a>
DSP	<a href="http://dsp.ti.com">dsp.ti.com</a>
Clocks and Timers	<a href="http://www.ti.com/clocks">www.ti.com/clocks</a>
Interface	<a href="http://interface.ti.com">interface.ti.com</a>
Logic	<a href="http://logic.ti.com">logic.ti.com</a>
Power Mgmt	<a href="http://power.ti.com">power.ti.com</a>
Microcontrollers	<a href="http://microcontroller.ti.com">microcontroller.ti.com</a>
RFID	<a href="http://www.ti-rfid.com">www.ti-rfid.com</a>
RF/IF and ZigBee® Solutions	<a href="http://www.ti.com/lprf">www.ti.com/lprf</a>

### Applications

Communications and Telecom	<a href="http://www.ti.com/communications">www.ti.com/communications</a>
Computers and Peripherals	<a href="http://www.ti.com/computers">www.ti.com/computers</a>
Consumer Electronics	<a href="http://www.ti.com/consumer-apps">www.ti.com/consumer-apps</a>
Energy and Lighting	<a href="http://www.ti.com/energy">www.ti.com/energy</a>
Industrial	<a href="http://www.ti.com/industrial">www.ti.com/industrial</a>
Medical	<a href="http://www.ti.com/medical">www.ti.com/medical</a>
Security	<a href="http://www.ti.com/security">www.ti.com/security</a>
Space, Avionics and Defense	<a href="http://www.ti.com/space-avionics-defense">www.ti.com/space-avionics-defense</a>
Transportation and Automotive	<a href="http://www.ti.com/automotive">www.ti.com/automotive</a>
Video and Imaging	<a href="http://www.ti.com/video">www.ti.com/video</a>
Wireless	<a href="http://www.ti.com/wireless-apps">www.ti.com/wireless-apps</a>

TI E2E Community Home Page

[e2e.ti.com](http://e2e.ti.com)

Mailing Address: Texas Instruments, Post Office Box 655303, Dallas, Texas 75265  
Copyright © 2011, Texas Instruments Incorporated