

PT4560 Series

30-W 48-V Input
Isolated DC/DC Converter

SLTS097C

(Revised 3/14/2002)

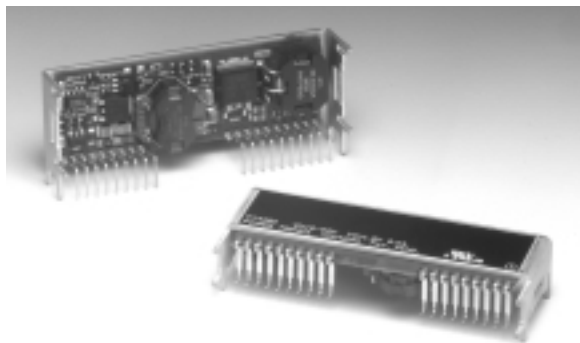

Features

- Input Voltage Range: 36V to 75V
- 1500 VDC Isolation
- On/Off Control
- V_o Adjust
- Differential Remote Sense
- Current Limit
- Short-Circuit Protection
- Over-Temperature Shutdown
- Undervoltage Lockout
- Space-Saving Package
- Solderable Copper Case
- UL1950 Recognized
- CSA 22.2 950 Certified
- EN60950 Approved
- VDE Licensed
- 4.9 x10⁶ Hrs MTBF
- Meets FCC Class A Radiated Limits

Description

The PT4560 series is a single-output isolated DC/DC converter, housed in a 19-pin space-saving package. These modules are UL, CSA, and VDE approved for telecom applications, and rated at 30 watts or 8 A. Standard output voltages range from 1.8 V to 15 V, each adjustable by up to $\pm 10\%$ of nominal.

Operating features include a remote on/off control, an under-voltage-lockout (UVLO), and a differential remote sense. The PT4560 series also incorporates many protection features. These include output current limit, short-circuit protection, and over-temperature shutdown.

PT4560 requires a 330 μ F of output capacitance for proper operation.

Ordering Information

PT4561□ = 3.3V/8A (26.4W)

PT4562□ = 5.0V/6A

PT4563□ = 12.0V/2.5A

PT4564□ = 15.0V/2A

PT4565□ = 2.0V/8A (16W)

PT4566□ = 2.5V/8A (20W)

PT4567□ = 1.8V/8A (14.4W)

PT4568□ = 5.2V/6A

PT4571□ = 9.0V/3.3A

PT Series Suffix (PT1234 x)

Case/Pin Configuration	Order Suffix	Package Code *
Vertical	N	(END)
Horizontal	A	(ENA)
SMD	C	(ENC)

* Previously known as package styles 1400 & 1410.

(Reference the applicable package code drawing for the dimensions and PC board layout)

Pin-Out Information

Pin	Function
1	Do Not Use
2	Remote On/Off †
3	Do Not Use
4	- V_{in}
5	- V_{in}
6	- V_{in}
7	+ V_{in}
8	+ V_{in}
9	+ V_{in}
10	- V_o
11	- V_o
12	- V_o
13	-Remote Sense
14	+ V_o
15	+ V_o
16	+ V_o
17	+ V_o
18	V_o Adjust †
19	+Remote Sense

† For more information, see application notes.

Standard Application

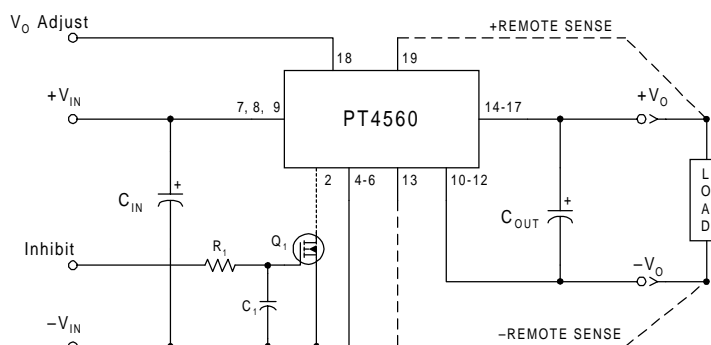

C_{in} = Optional 100 μ F/100V electrolytic
 C_{out} = Required 330 μ F electrolytic (See Notes)
 Q_1 = N-Channel MOSFET
 R_1/C_1 = Optional (see application notes)

PT4560 Series

30-W 48-V Input
Isolated DC/DC Converter**Specifications** (Unless otherwise stated, $T_a = 25^\circ\text{C}$, $V_{in} = 48\text{V}$, $C_{out} = 330\mu\text{F}$, and $I_o = I_{o,max}$)

Characteristic	Symbol	Conditions	PT4560 SERIES			Units	
			Min	Typ	Max		
Output Current	I_o	Over V_{in} range	$V_o = 15\text{V}$	0.1 (1)	—	2.0	A
			$V_o = 12\text{V}$	0.1 (1)	—	2.5	
			$V_o = 9.0\text{V}$	0.1 (1)	—	3.3	
			$V_o = 5.0\text{V}$	0.25 (1)	—	6.0	
			$V_o \leq 3.3\text{V}$	0.25 (1)	—	8.0	
Input Voltage Range	V_{in}	Over I_o Range	36.0	48.0	75.0	V	
Set Point Voltage Tolerance	V_o tol		$V_o \geq 5.0\text{V}$	—	± 1	± 1.5	$\%V_o$
			$V_o \leq 3.3\text{V}$	—	± 33	± 50	mV
Temperature Variation	Reg_{temp}	$-40^\circ \leq T_a \leq +85^\circ\text{C}$	—	± 0.5	—	$\%V_o$	
Line Regulation	Reg_{line}	Over V_{in} range	$V_o \geq 5.0\text{V}$	—	± 0.2	± 1.0	$\%V_o$
			$V_o \leq 3.3\text{V}$	—	± 7	± 33	mV
Load Regulation	Reg_{load}	Over I_o range	$V_o \geq 5.0\text{V}$	—	± 0.4	± 1.0	$\%V_o$
			$V_o \leq 3.3\text{V}$	—	± 13	± 33	mV
Total Output Voltage Variation	$\Delta V_{o,tot}$	Includes set-point, line, load, $-40^\circ \leq T_a \leq +85^\circ\text{C}$	$V_o \geq 5.0\text{V}$	—	± 2	—	$\%V_o$
Efficiency	η		$V_o = 15\text{V}$	—	85	—	%
			$V_o = 12\text{V}$	—	87	—	
			$V_o = 9.0\text{V}$	—	84	—	
			$V_o = 5.0\text{V}$	—	84	—	
			$V_o = 3.3\text{V}$	—	80	—	
V_o Ripple (pk-pk)	V_r	20MHz bandwidth	$V_o \geq 5.0\text{V}$	—	1.0	2.0	$\%V_o$
			$V_o \leq 3.3\text{V}$	—	50	75	mV _{pp}
Transient Response	t_{tr}	0.1A/ μs load step, 50% to 100% $I_{o,max}$	—	100	200	μs	
	ΔV_{tr}	V_o over/undershoot	$V_o \geq 5.0\text{V}$	—	± 3.0	± 5.0	$\%V_o$
			$V_o \leq 3.3\text{V}$	—	± 100	± 150	mV
				—	$2 \times I_{o,max}$	—	A
Switching Frequency	f_s	Over V_{in} range	$V_o \geq 10\text{V}$	400	500	600	kHz
Under-Voltage Lockout	UVLO	V_{in} increasing V_{in} decreasing		—	34	—	V
				—	33	—	
Remote On/Off Input (pin 2)	V_{IH} V_{IL} I_{IL}	Referenced to $-V_{in}$ (pins 4-6)		2.5	—	15 (2)	V
				-0.2	—	+0.8	
				-3	-6	-10	
Standby Input Current	$I_{in, standby}$	pins 2 & 4 connected	—	8	16	mA	
Internal Input Capacitance	C_{in}		—	0.66	—	μF	
External Output Capacitance	C_{out}	Between $+V_o$ and $-V_o$	$V_o \geq 9.0\text{V}$	260	330	600 (3)	μF
			$V_o \leq 5.0\text{V}$	260	330	1,000 (3)	
Isolation Voltage	Capacitance Resistance	Input-output/input-case	1500	—	—	Vdc	
		Input-output	—	1200	—	pF	
		Input-output	10	—	—	M Ω	
Operating Temperature Range	T_a	Over V_{in} range	-40 (4)	—	+85 (5)	$^\circ\text{C}$	
Maximum Case Temperature	T_c		—	—	100	$^\circ\text{C}$	
Storage Temperature Range	T_s		-40	—	+125	$^\circ\text{C}$	
Reliability	MTBF	Per Bellcore TR-332 50% stress, $T_a = 40^\circ\text{C}$, ground benign	4.9	—	—	10^6 Hrs	
Mechanical Shock	—	Per Mil-Std-883D, method 2002.3, 1mS, half-sine, mounted to a fixture	—	500	—	G's	
Mechanical Vibration	—	Per Mil-Std-883D, method 2007.2, 20-2000Hz, soldered in board	—	20	—	G's	
Weight	—		—	40	—	grams	
Flammability	—	Materials meet UL 94V-0	—	—	—		

Notes: (1) The DC/DC converter will operate at no load with reduced specifications.

(2) The Remote On/Off input has an internal pull-up. If it is left open circuit the PT4560 will operate when input power is applied. A low-leakage (<100nA) MOSFET is recommended to control this input. The open-circuit voltage is less than 10V. See application notes for interface considerations.

(3) Output capacitor values are absolute. Allowances must be made for any additional de-coupling capacitors and the total external capacitor tolerance. The value of external capacitance is limited due to regulator startup current requirements. Consult the factory for further details.

(4) For operation below 0°C , the required external output capacitor must have temperature stable characteristics. E.g. Tantalum or Oscon® types.

(5) See Safe Operating Area curves or contact the factory for the appropriate thermal derating.

PT4560 Series

Typical Characteristics

30-W 48-V Input
Isolated DC/DC Converter

PT4567, 1.8 VDC (See Note A)

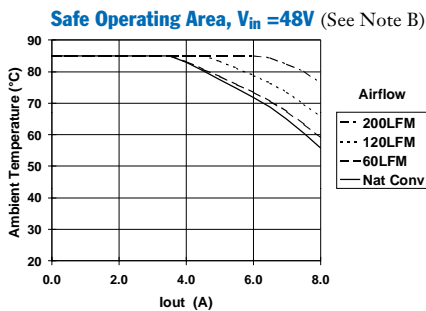
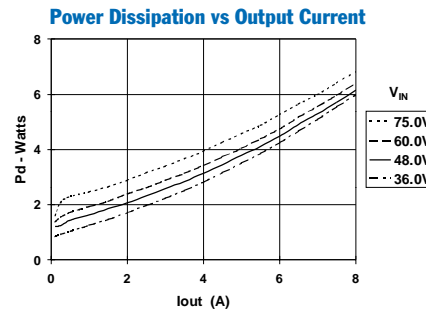
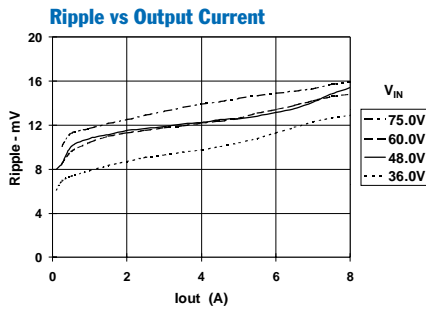
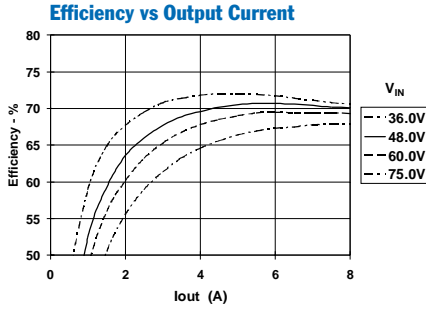

PT4561, 3.3 VDC (See Note A)

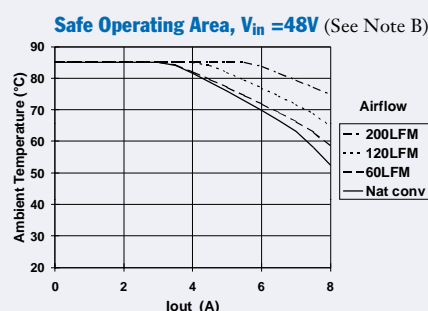
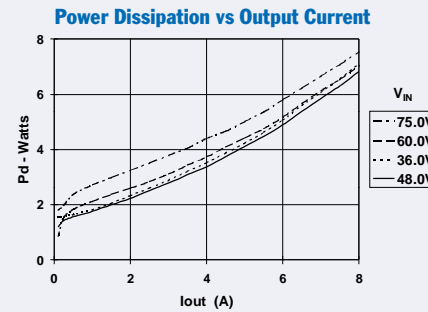
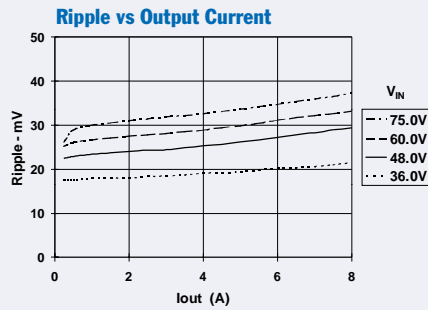
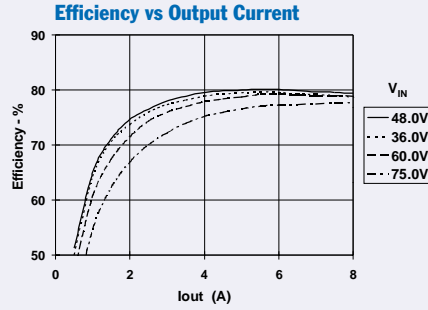

PT4562, 5.0 VDC (See Note A)

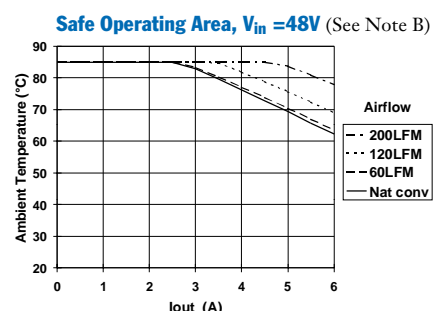
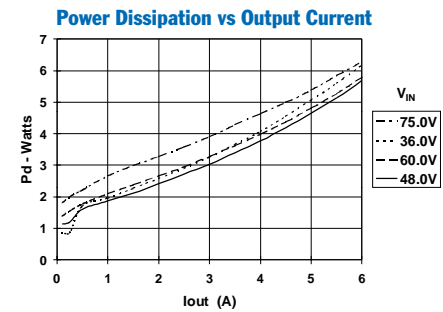
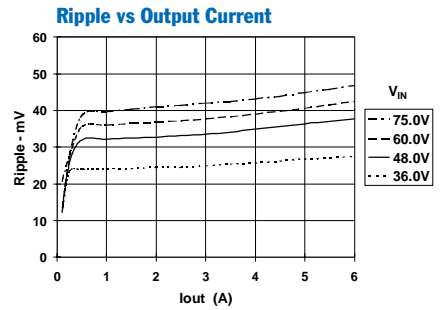
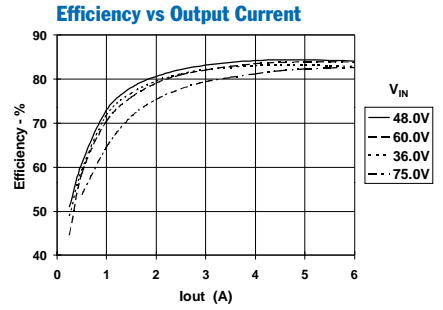

Note A: All data listed in the above graphs has been developed from actual products tested at 25°C. This data is considered typical data for the DC-DC Converter.
Note B: SOA curves represent operating conditions at which internal components are at or below manufacturer's maximum rated operating temperature.

PT4560 Series

30-W 48-V Input
Isolated DC/DC Converter

Typical Characteristics

PT4571, 9.0 VDC (See Note A)

Efficiency vs Output Current

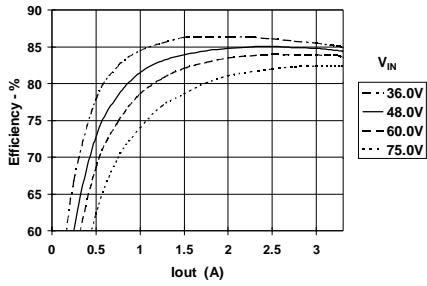

Ripple vs Output Current

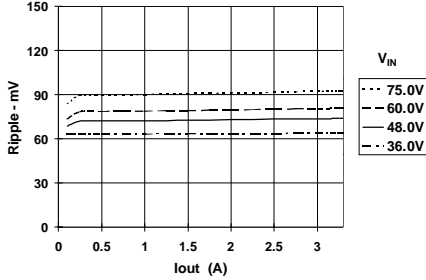

Power Dissipation vs Output Current

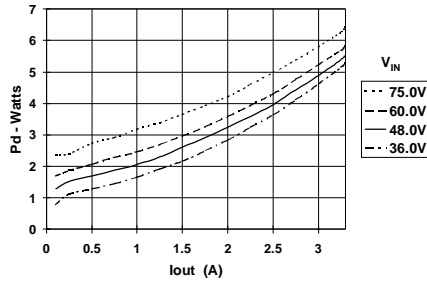

Safe Operating Area, VIN = 48V (See Note B)

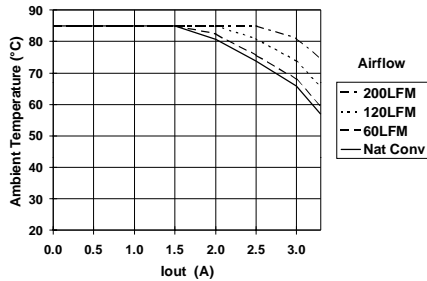

PT4563, 12.0 VDC (See Note A)

Efficiency vs Output Current

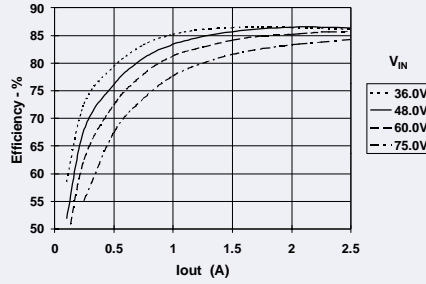

Ripple vs Output Current

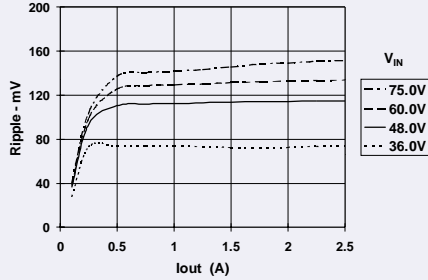

Power Dissipation vs Output Current

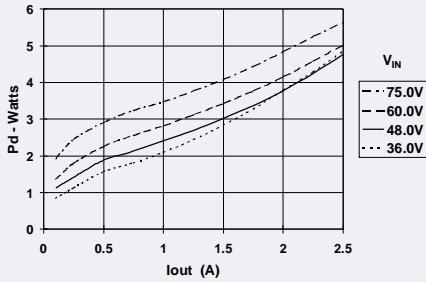

Safe Operating Area, VIN = 48V (See Note B)

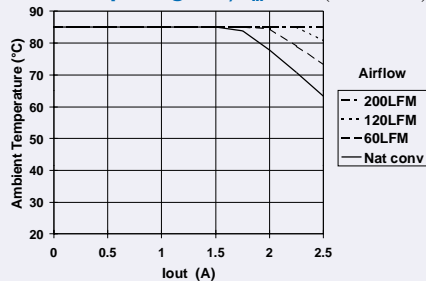

PT4564, 15 VDC (See Note A)

Efficiency vs Output Current

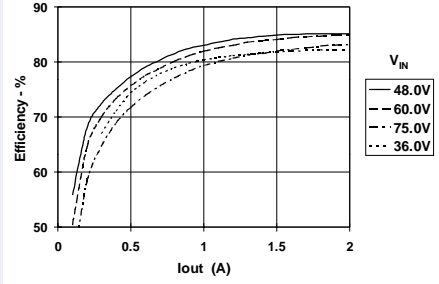

Ripple vs Output Current

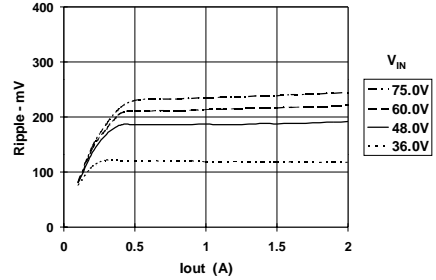

Power Dissipation vs Output Current

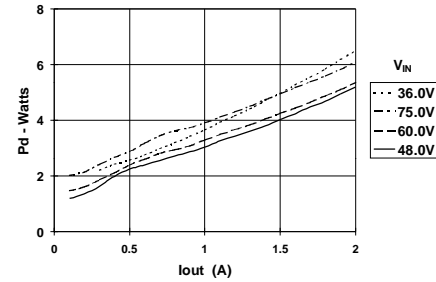

Safe Operating Area, VIN = 48V (See Note B)

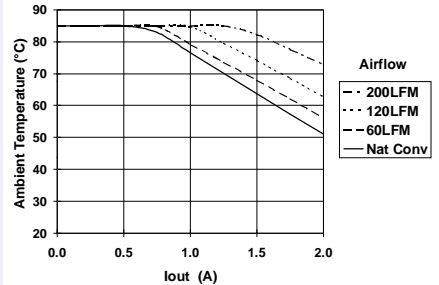

Note A: All data listed in the above graphs has been developed from actual products tested at 25°C. This data is considered typical data for the DC-DC Converter.
 Note B: SOA curves represent operating conditions at which internal components are at or below manufacturer's maximum rated operating temperature.

Application Notes

PT3320/3340/4560/4580 Series

Adjusting the Output Voltage of Power Trends' 30W Isolated DC/DC Converter Series

The factory pre-set output voltage of Power Trends' 30W series of isolated DC/DC converters may be adjusted within a nominal $\pm 10\%$ range. This is accomplished with the addition of a single external resistor. For the input voltage range specified in the data sheet, Table 1 gives the allowable adjustment range for each model as V_o (min) and V_o (max).

Adjust Up: An increase in the output voltage is obtained by adding a resistor, R_2 between V_o adjust (pin 18), and -Remote Sense (pin 13). See note 4.

Adjust Down: Add a resistor (R_1), between V_o adjust (pin 18), and +Remote Sense (pin 19).

Refer to Figure 1 and Tables 2 & 3 for both the placement and value of the required resistor, (R_1) or R_2 .

Notes:

1. Use only a single 1% resistor in either the (R_1) or R_2 location. Place the resistor as close to the ISR as possible.
2. Never connect capacitors to V_o adjust. Any capacitance added to the V_o adjust control pin will affect the stability of the ISR.

3. If the remote sense pins are not being used, the resistors (R_1) and R_2 can be connected to $+V_{out}$ or $-V_{out}$ respectively.
4. The adjusted output voltage, V_a effectively sets the voltage across pins 13 and 19 (\pm Remote Sense). When using the remote sense pins, V_{out} (measured directly across pins 10–12, and 14–17) can be significantly higher than V_a , and may exceed V_o (max). If V_a is adjusted upward of V_o (max), the minimum input voltage is increased by the same percentage as V_{out} exceeds V_o (max).

The values of (R_1) [adjust down], and R_2 [adjust up], can also be calculated using the following formulas.

$$(R_1) = \frac{K_o (V_a - V_r)}{V_r (V_o - V_a)} - R_s \quad \text{k}\Omega$$

$$R_2 = \frac{K_o}{(V_a - V_o)} - R_s \quad \text{k}\Omega$$

Where V_o = Original output voltage
 V_a = Adjusted output voltage
 V_r = Reference voltage (Table 1)
 K_o = Multiplier constant (Table 1)
 R_s = Series resistance (Table 1)

Table 1

DC/DC CONVERTER ADJUSTMENT RANGE AND FORMULA PARAMETERS

Series Pt #									
AL Case:									
24V Bus					PT3341	PT3342		PT3343	PT3344
48V Bus	PT3327	PT3325	PT3326		PT3321	PT3322		PT3323	PT3324
CU Case:									
24V Bus	PT4585				PT4581	PT4582		PT4583	PT4584
48V Bus	PT4567	PT4565	PT4566		PT4561	PT4562	PT4571	PT4563	PT4564
V_o (nom)	1.8V	1.8V	2.0V	2.5V	3.3V	5.0V	9.0V	12.0V	15.0V
V_o (min)	1.62V	1.62V	1.8V	2.25V	2.95V	4.5V	7.0V	10.8V	13.5V
V_o (max)	2.5V	1.98V	2.2V	2.75V	3.65V	5.5V	10.0V	13.2V	16.5V
V_r	1.225V	1.225V	1.225V	1.225V	1.225V	1.225V	2.5V	2.5V	2.5V
K_o (V·k Ω)	69.58	69.58	62.47	42.33	68.89	68.71	133.25	135.9	137.5
R_s (k Ω)	80.6	80.6	150.0	121.0	150.0	121.0	110	90.9	80.6

Figure 1

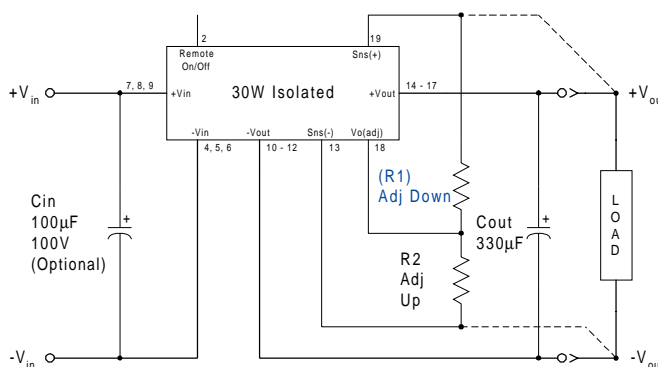

PT3320/3340/4560/4580 Series

Table 2

DC/DC CONVERTER ADJUSTMENT RESISTOR VALUES

Series Pt #					
Al Case					
24V Bus					PT3341
48V Bus	PT3327	PT3325	PT3326	PT3321	
CU Case					
24V Bus	PT4585				PT4581
48V Bus	PT4567	PT4565	PT4566	PT4561	
Current	8A _{dc}	8A _{dc}	8A _{dc}	8A _{dc}	8A _{dc}
V _o (nom)	1.8V	1.8V	2.0V	2.5V	3.3V
V_a(req'd)					
1.65	(80.3)k Ω	(80.3)k Ω			
1.7	(189.0)k Ω	(189.0)k Ω			
1.75	(516.0)k Ω	(516.0)k Ω			
1.8					
1.85	1.31M Ω	1.31M Ω	(62.5)k Ω		
1.9	615.0k Ω	615.0k Ω	(194.0)k Ω		
1.95	383.0k Ω	383.0k Ω	(589.0)k Ω		
2.0	267.0k Ω				
2.05	198.0k Ω	1.1M Ω			
2.1	151.0k Ω	475.0k Ω			
2.15	118.0k Ω	266.0k Ω			
2.2	93.3k Ω	162.0k Ω			
2.25	74.0k Ω				(20.7)k Ω
2.3	58.6k Ω				(64.7.0)k Ω
2.35	45.9k Ω				(138.0)k Ω
2.4	35.4k Ω				(285.0)k Ω
2.45	26.4k Ω				(726.0)k Ω
2.5	18.8k Ω				
2.55				726.0k Ω	
2.6				302.0k Ω	
2.65				161.0k Ω	
2.7				90.6k Ω	
2.75				48.3k Ω	
2.95					(127.0)k Ω
3.0					(183.0)k Ω
3.05					(261.0)k Ω
3.1					(377.0)k Ω
3.15					(572.0)k Ω
3.2					(961.0)k Ω
3.25					(2.13)M Ω
3.3					
3.35					1.23M Ω
3.4					539.0k Ω
3.45					309.0k Ω
3.5					194.0k Ω
3.55					126.0k Ω
3.6					79.6k Ω
3.65					46.8k Ω

R1 = (Blue) R2 = Black

Application Notes

PT3320/3340/4560/4580 Series

Table 3

DC/DC CONVERTER ADJUSTMENT RESISTOR VALUES

Series Pt #

AL Case

24V Bus PT3342

PT3343 PT3344

48V Bus PT3322

PT3323 PT3324

CU Case

24V Bus PT4582

PT4583 PT4584

48V Bus PT4562

PT4571 PT4563 PT4564

Current 6A_{dc}3.3A_{dc} 2.5A_{dc} 2.0A_{dc}V_o(nom) 5.0V

9.0V 12.0V 15.0V

V_a(req'd)V_a(req'd)

4.5	(246.0)kΩ	7.0	(9.9)kΩ
4.55	(293.0)kΩ	7.2	(29.2)kΩ
4.6	(352.0)kΩ	7.4	(53.2)kΩ
4.65	(428.0)kΩ	7.6	(84.2)kΩ
4.7	(529.0)kΩ	7.8	(125.0)kΩ
4.75	(670.0)kΩ	8.0	(183.0)kΩ
4.8	(882.0)kΩ	8.2	(270.0)kΩ
4.85	(1.23)MΩ	8.4	(414.0)kΩ
4.9	(1.94)MΩ	8.6	(703.0)kΩ
4.95		8.8	(1.57)MΩ
5.0		9.0	
5.05		9.2	556.0kΩ
5.1	566.0kΩ	9.4	223.0kΩ
5.15	337.0kΩ	9.6	112.0kΩ
5.2	223.0kΩ	9.8	56.6kΩ
5.25	154.0kΩ	10.0	23.3kΩ
5.3	108.0kΩ	•	
5.35	75.3kΩ	10.8	(285.0)kΩ
5.4	50.8kΩ	11.0	(371.0)kΩ
5.45	31.7kΩ	11.2	(500.0)kΩ
5.5	16.4kΩ	11.4	(715.0)kΩ
		11.6	(1.15)MΩ
		11.8	
		12.0	
		12.2	588.0kΩ
		12.4	249.0kΩ
		12.6	136.0kΩ
		12.8	78.9kΩ
		13.0	45.0kΩ
		13.2	22.3kΩ
		•	
		13.5	(323.0)kΩ
		13.6	(355.0)kΩ
		13.8	(437.0)kΩ
		14.0	(522.0)kΩ
		14.2	(724.0)kΩ
		14.4	(1010.0)kΩ
		14.6	(1.58)MΩ
		14.8	
		15.0	
		15.2	607.0kΩ
		15.4	263.0kΩ
		15.6	149.0kΩ
		15.8	91.3kΩ
		16.0	56.9kΩ
		16.5	11.1kΩ

R1 = (Blue) R2 = Black

Application Notes

PT3320/3340/4560/4580 Series

Using Remote On/Off on Power Trends' 30W Isolated DC-DC Converter Series

Power Trends' 30W isolated series of DC/DC converters incorporate a *Remote On/Off* function. This function may be used in applications for battery conservation, power-up/shutdown sequencing, or to co-ordinate the power-up of the regulator for active in-rush current control. (See TI application reports, SLTA021, and SLUA250).

The Remote On/Off function is provided by pin 2. If pin 2 is left open-circuit, the converter provides a regulated output whenever a valid source voltage ¹ is applied between +V_{in} (pins 7-9), and -V_{in} (pins 4-6). Applying a low voltage ², with respect to -V_{in} (pin 2), disables the regulator output ³. Table 1 details the control requirements for this input. Figure 1 shows how a discrete MOSFET (Q₁) may be referenced to the negative input voltage rail to control the Remote On/Off pin.

Table 1 Remote On/Off Control Requirements ²

Parameter	min	max
Enable (V _{IH})	2.5V ⁵	15V (or open circuit) ⁴
Disable (V _{IL})	-0.3V	0.8V

Notes:

- These converters incorporate an "Under Voltage Lockout" (UVLO) function. This function automatically holds the converter output in the "Off" state until there is sufficient input voltage for the converter to produce a regulated output. Table 2 gives the applicable UVLO thresholds.

Table 2 UVLO Thresholds

Series	UVLO Threshold	V _{in} Range
PT3320/4560	34 ± 2.0V	36 – 75V
PT3340/4580	16.5 ± 1.5V	18 – 60V

- The Remote On/Off control pin uses -V_{in} (pins 4-6) as its ground reference. All voltages specified are with respect to -V_{in}.
- When the converter output is disabled the current drawn from the input supply is typically reduced to 8mA (16mA maximum).
- The internal circuitry comprises of a high impedance (3μA -10μA) current source. The open-circuit voltage is less than 10V.
- The Remote On/Off pin is ideally controlled using devices with an open-collector (or open-drain) output. A small low-leakage MOSFET (<100nA) is recommended. A pull-up resistor is not required, but may be necessary to ensure that the Remote On/Off pin exceeds V_{IH}(min) (see Table 1). *Do not* use a pull-up resistor to the +V_{in} input, or drive the pin above V_{IH}(max).

- Keep the on/off transition to less than 1ms. This prevents erratic operation of the ISR, whereby the output voltage may drift un-regulated between 0V and the rated output voltage during power-up.
- In Figure 1, Q₁ is a low-threshold MOSFET. The components R₁ and C₁ are added to improve noise susceptibility.

Figure 1

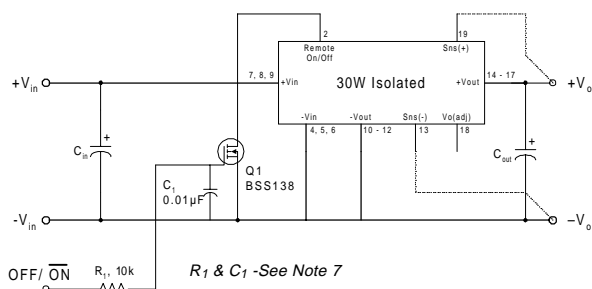

Turn-On Time: When the Remote On/Off input is left open-circuit, the output of the converter is automatically enabled when a valid input voltage ¹ is applied to the input power pins. The converter typically rises to full regulation within 30ms of the application of power (or after the release of the Remote On/Off pin with input power applied). The actual turn-on time will vary with the input voltage, output load, and the total amount of capacitance connected to the output. Using the circuit of Figure 1, Figure 2 shows the typical output voltage and input current waveforms for a PT3322/PT4562 after Q₁ is turned off. The turn off of Q₁ correlates with the fall of the Q₁ V_{gs} waveform. The waveforms were measured with a 48Vdc input voltage, and 5-A resistive load.

Figure 2

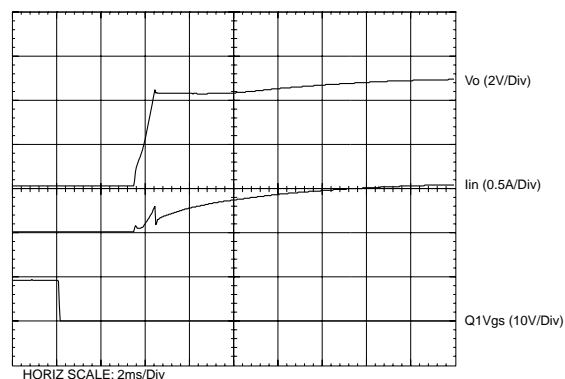

VDE Approved Installation Instructions (Installationsanleitung)

Nennspannung (Rated Voltage):	PT4560 36 to 72 Vdc, Transient to 75Vdc PT4580 18 to 60 Vdc, PT4599 19 to 31 Vdc	
Nennaufnahme (Rated Input):	PT4560 1.5 Adc PT4580, PT4599 3.0 Adc	
Nennleistung (Rated Power):	30 Watts Maximum	
Ausgangsspannung (Sec. Voltage):	PT4560 Series PT4561, 3.3 Vdc, 8.0 Adc PT4562, 5.0 Vdc, 6.0 Adc	PT4580 Series PT4581, 3.3 Vdc, 8.0 Adc PT4582, 5.0 Vdc, 6.0 Adc
Ausgangsstrom (Sec. Current): oder (or)	PT4563, 12.0 Vdc, 2.5 Adc PT4564, 15.0 Vdc, 2.0 Adc	PT4583, 12.0 Vdc, 2.5 Adc PT4584, 15.0 Vdc, 2.0 Adc
Ausgangsleistung (Sec. Power):	PT4565, 2.0 Vdc, 8.0 Adc PT4566, 2.5 Vdc, 8.0 Adc PT4567, 1.8 Vdc, 8.0 Adc PT4568, 5.2 Vdc, 6.0 Adc PT4569, 6.0 Vdc, 5.0 Adc PT4570, 8.0 Vdc, 3.75 Adc PT4571, 9.0 Vdc, 3.3 Adc	PT4585, 1.8 Vdc, 8.0 Adc PT4599, 5.0 Vdc, 6.0 Adc

Angabe der Umgebungstemperatur

(Information on ambient temperature): +85°C Ambient or 100°C Case Maximum

Besondere Hinweise (Special Instructions):

Es ist vorzusehen, daß die Spannungsversorgung in einer Endanwendung über eine isolierte Sekundärschaltung bereit gestellt wird. Die Eingangsspannung der Spannungsversorgungsmodule muss eine verstärkte Isolierung von der Wechselstromquelle aufweisen.

Die Spannungsversorgung muss gemäss den Gehäuse-, Montage-, Kriech- und Luftstrecken-, Markierungs- und Trennanforderungen der Endanwendung installiert werden. Bei Einsatz eines TNV-3-Einganges muss die SELV-Schaltung ordnungsgemäss geerdet werden.

(The power supply is intended to be supplied by isolated secondary circuitry in an end use application. The input power to these power supplies shall have reinforced insulation from the AC mains.)

The power supply shall be installed in compliance with the enclosure, mounting, creepage, clearance, casualty, markings, and segregation requirements of the end-use application. When the input is TNV-3, the SELV circuitry must be reliably grounded.)

Offenbach,

VDE Prüf- und Zertifizierungsinstitut
Abteilung / Department TD

(Jürgen Bärwinkel)

Ort / Place:

Datum / Date:

K. Yena 12/12/01

(Stempel und Unterschrift des Herstellers / Stamp
and signature of the manufacturer)

PACKAGING INFORMATION

Orderable Device	Status ⁽¹⁾	Package Type	Package Drawing	Pins	Package Qty	Eco Plan ⁽²⁾	Lead/ Ball Finish	MSL Peak Temp ⁽³⁾	Samples (Requires Login)
PT4561A	NRND	SIP MODULE	ENA	19	10	Pb-Free (RoHS)	Call TI	N / A for Pkg Type	
PT4561C	NRND	SIP MODULE	ENC	19	10	Pb-Free (RoHS)	Call TI	Level-3-215C-168HRS	
PT4561N	NRND	SIP MODULE	END	19	10	Pb-Free (RoHS)	Call TI	N / A for Pkg Type	
PT4562C	NRND	SIP MODULE	ENC	19	10	Pb-Free (RoHS)	Call TI	Level-3-215C-168HRS	
PT4562N	NRND	SIP MODULE	END	19	10	Pb-Free (RoHS)	Call TI	N / A for Pkg Type	
PT4563A	OBSOLETE	SIP MODULE	ENA	19		TBD	Call TI	Call TI	
PT4563C	NRND	SIP MODULE	ENC	19	10	Pb-Free (RoHS)	Call TI	Level-3-215C-168HRS	
PT4563N	NRND	SIP MODULE	END	19	10	Pb-Free (RoHS)	Call TI	N / A for Pkg Type	
PT4564C	NRND	SIP MODULE	ENC	19	10	TBD	Call TI	Level-3-215C-168HRS	
PT4564N	NRND	SIP MODULE	END	19	10	TBD	Call TI	Level-1-215C-UNLIM	
PT4566C	NRND	SIP MODULE	ENC	19	10	TBD	Call TI	Level-3-215C-168HRS	

⁽¹⁾ The marketing status values are defined as follows:

ACTIVE: Product device recommended for new designs.

LIFEBUY: TI has announced that the device will be discontinued, and a lifetime-buy period is in effect.

NRND: Not recommended for new designs. Device is in production to support existing customers, but TI does not recommend using this part in a new design.

PREVIEW: Device has been announced but is not in production. Samples may or may not be available.

OBSOLETE: TI has discontinued the production of the device.

⁽²⁾ Eco Plan - The planned eco-friendly classification: Pb-Free (RoHS), Pb-Free (RoHS Exempt), or Green (RoHS & no Sb/Br) - please check <http://www.ti.com/productcontent> for the latest availability information and additional product content details.

TBD: The Pb-Free/Green conversion plan has not been defined.

Pb-Free (RoHS): TI's terms "Lead-Free" or "Pb-Free" mean semiconductor products that are compatible with the current RoHS requirements for all 6 substances, including the requirement that lead not exceed 0.1% by weight in homogeneous materials. Where designed to be soldered at high temperatures, TI Pb-Free products are suitable for use in specified lead-free processes.

Pb-Free (RoHS Exempt): This component has a RoHS exemption for either 1) lead-based flip-chip solder bumps used between the die and package, or 2) lead-based die adhesive used between the die and leadframe. The component is otherwise considered Pb-Free (RoHS compatible) as defined above.

Green (RoHS & no Sb/Br): TI defines "Green" to mean Pb-Free (RoHS compatible), and free of Bromine (Br) and Antimony (Sb) based flame retardants (Br or Sb do not exceed 0.1% by weight in homogeneous material)

⁽³⁾ MSL, Peak Temp. -- The Moisture Sensitivity Level rating according to the JEDEC industry standard classifications, and peak solder temperature.

Important Information and Disclaimer: The information provided on this page represents TI's knowledge and belief as of the date that it is provided. TI bases its knowledge and belief on information provided by third parties, and makes no representation or warranty as to the accuracy of such information. Efforts are underway to better integrate information from third parties. TI has taken and continues to take reasonable steps to provide representative and accurate information but may not have conducted destructive testing or chemical analysis on incoming materials and chemicals. TI and TI suppliers consider certain information to be proprietary, and thus CAS numbers and other limited information may not be available for release.

In no event shall TI's liability arising out of such information exceed the total purchase price of the TI part(s) at issue in this document sold by TI to Customer on an annual basis.

IMPORTANT NOTICE

Texas Instruments Incorporated and its subsidiaries (TI) reserve the right to make corrections, enhancements, improvements and other changes to its semiconductor products and services per JESD46C and to discontinue any product or service per JESD48B. Buyers should obtain the latest relevant information before placing orders and should verify that such information is current and complete. All semiconductor products (also referred to herein as "components") are sold subject to TI's terms and conditions of sale supplied at the time of order acknowledgment.

TI warrants performance of its components to the specifications applicable at the time of sale, in accordance with the warranty in TI's terms and conditions of sale of semiconductor products. Testing and other quality control techniques are used to the extent TI deems necessary to support this warranty. Except where mandated by applicable law, testing of all parameters of each component is not necessarily performed.

TI assumes no liability for applications assistance or the design of Buyers' products. Buyers are responsible for their products and applications using TI components. To minimize the risks associated with Buyers' products and applications, Buyers should provide adequate design and operating safeguards.

TI does not warrant or represent that any license, either express or implied, is granted under any patent right, copyright, mask work right, or other intellectual property right relating to any combination, machine, or process in which TI components or services are used. Information published by TI regarding third-party products or services does not constitute a license to use such products or services or a warranty or endorsement thereof. Use of such information may require a license from a third party under the patents or other intellectual property of the third party, or a license from TI under the patents or other intellectual property of TI.

Reproduction of significant portions of TI information in TI data books or data sheets is permissible only if reproduction is without alteration and is accompanied by all associated warranties, conditions, limitations, and notices. TI is not responsible or liable for such altered documentation. Information of third parties may be subject to additional restrictions.

Resale of TI components or services with statements different from or beyond the parameters stated by TI for that component or service voids all express and any implied warranties for the associated TI component or service and is an unfair and deceptive business practice. TI is not responsible or liable for any such statements.

Buyer acknowledges and agrees that it is solely responsible for compliance with all legal, regulatory and safety-related requirements concerning its products, and any use of TI components in its applications, notwithstanding any applications-related information or support that may be provided by TI. Buyer represents and agrees that it has all the necessary expertise to create and implement safeguards which anticipate dangerous consequences of failures, monitor failures and their consequences, lessen the likelihood of failures that might cause harm and take appropriate remedial actions. Buyer will fully indemnify TI and its representatives against any damages arising out of the use of any TI components in safety-critical applications.

In some cases, TI components may be promoted specifically to facilitate safety-related applications. With such components, TI's goal is to help enable customers to design and create their own end-product solutions that meet applicable functional safety standards and requirements. Nonetheless, such components are subject to these terms.

No TI components are authorized for use in FDA Class III (or similar life-critical medical equipment) unless authorized officers of the parties have executed a special agreement specifically governing such use.

Only those TI components which TI has specifically designated as military grade or "enhanced plastic" are designed and intended for use in military/aerospace applications or environments. Buyer acknowledges and agrees that any military or aerospace use of TI components which have **not** been so designated is solely at the Buyer's risk, and that Buyer is solely responsible for compliance with all legal and regulatory requirements in connection with such use.

TI has specifically designated certain components which meet ISO/TS16949 requirements, mainly for automotive use. Components which have not been so designated are neither designed nor intended for automotive use; and TI will not be responsible for any failure of such components to meet such requirements.

Products

Audio	www.ti.com/audio
Amplifiers	amplifier.ti.com
Data Converters	dataconverter.ti.com
DLP® Products	www.dlp.com
DSP	dsp.ti.com
Clocks and Timers	www.ti.com/clocks
Interface	interface.ti.com
Logic	logic.ti.com
Power Mgmt	power.ti.com
Microcontrollers	microcontroller.ti.com
RFID	www.ti-rfid.com
OMAP Mobile Processors	www.ti.com/omap
Wireless Connectivity	www.ti.com/wirelessconnectivity

Applications

Automotive and Transportation	www.ti.com/automotive
Communications and Telecom	www.ti.com/communications
Computers and Peripherals	www.ti.com/computers
Consumer Electronics	www.ti.com/consumer-apps
Energy and Lighting	www.ti.com/energy
Industrial	www.ti.com/industrial
Medical	www.ti.com/medical
Security	www.ti.com/security
Space, Avionics and Defense	www.ti.com/space-avionics-defense
Video and Imaging	www.ti.com/video

TI E2E Community e2e.ti.com