

### Features

- Dual Outputs  
(Independently Regulated)
- Power-up/Down Sequencing
- Input Voltage Range:  
18V to 36V
- 1500 VDC Isolation
- Temp Range: -40° to 100°C
- High Efficiency: 88%
- Fixed Frequency Operation
- Over-Current Protection  
(Both Outputs)
- Dual Logic On/Off Control
- Over-Temperature Shutdown
- Over-Voltage Protection  
(Coordinated Shutdown)
- Under-Voltage Lockout
- Input Differential EMI Filter
- Solderable Copper Case
- Safety Approvals (Pending):  
UL 60950  
CSA 22.2 60950

### Description

The PT4680 Excalibur™ Series is a dual-output isolated DC/DC converter that combine state-of-the-art power conversion technology with unparalleled flexibility. Operating from a (-24V) industry standard input bus, the PT4680 series provides up to 20 ADC of output current from two independently regulated voltages (each output 15 ADC max).

The PT4680 series is characterized with high efficiencies and ultra-fast transient response, and incorporates many features to facilitate system integration. These include a flexible “On/Off” enable control, output

current limit, over-temperature protection, and an input under-voltage lock-out. In addition, both output voltages are designed to meet the power-up/power-down sequencing requirements of popular DSP ICs.

The PT4680 series is housed in space-saving solderable copper case. The package does not require a heatsink and is available in both vertical and horizontal configurations, including surface mount. The ‘N’ configuration occupies less than 2 in<sup>2</sup> of PCB area.

### Ordering Information

Pt. No.	Vo <sub>1</sub> /Vo <sub>2</sub>
<b>PT4681</b> □	= 5.0/3.3 Volts
<b>PT4682</b> □	= 3.3/2.5 Volts
<b>PT4683</b> □	= 3.3/1.8 Volts
<b>PT4685</b> □	= 3.3/1.5 Volts
<b>PT4686</b> □	= 2.5/1.8 Volts
<b>PT4687</b> □	= 5.0/1.8 Volts

### PT Series Suffix (PT1234 x)

Case/Pin Configuration	Order Suffix	Package Code
Vertical	<b>N</b>	(EKD)
Horizontal	<b>A</b>	(EKA)
SMD	<b>C</b>	(EKC)

(Reference the applicable package code drawing for the dimensions and PC board layout)

### Typical Application

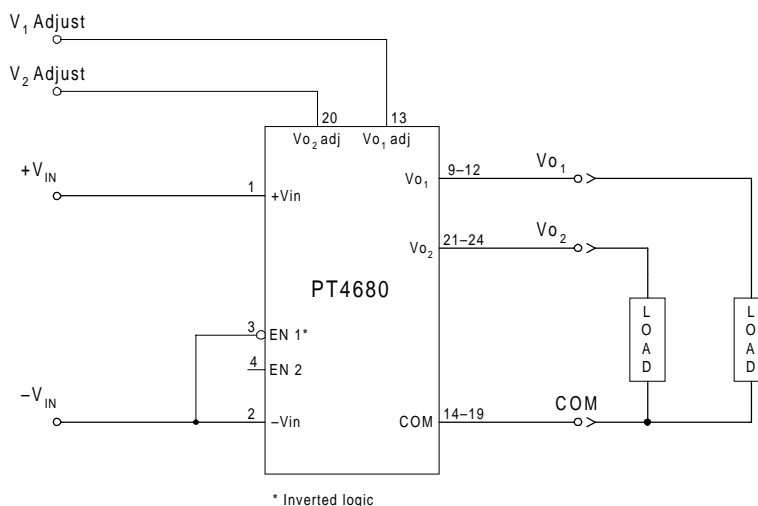

## Pin-Out Information

Pin	Function	Pin	Function	Pin	Function
1	+V <sub>in</sub>	10	+Vo <sub>1</sub>	19	COM
2	-V <sub>in</sub>	11	+Vo <sub>1</sub>	20	Vo <sub>2</sub> Adjust
3	EN 1	12	+Vo <sub>1</sub>	21	+Vo <sub>2</sub>
4	EN 2	13	Vo <sub>1</sub> Adjust	22	+Vo <sub>2</sub>
5	TEMP	14	COM	23	+Vo <sub>2</sub>
6	AUX	15	COM	24	+Vo <sub>2</sub>
7	Do Not Connect	16	COM	25	Do Not Connect
8	Do Not Connect	17	COM	26	Do Not Connect
9	+Vo <sub>1</sub>	18	COM		

Note: Shaded functions indicate signals that are referenced to the input (-V<sub>in</sub>) potential.

## On/Off Logic

Pin 3	Pin 4	Output Status
1	×	Off
0	1	On
×	0	Off

## Notes:

Logic 1 = Open collector

Logic 0 = -V<sub>in</sub> (pin 2) potential

For positive Enable function, connect pin 3 to pin 2 and use pin 4.

For negative Enable function, leave pin 4 open and use pin 3.

## Pin Descriptions

**+V<sub>in</sub>:** The positive input supply for the module with respect to -V<sub>in</sub>. If powering the module from a -24V telecom central office supply, this input is connected to the primary system ground.

**-V<sub>in</sub>:** The negative input supply for the module, and the 0VDC reference for the EN 1, EN 2, TEMP, and AUX signals. When the module is powered from a +24V supply, this input is connected to the 24V Return.

**EN 1:** The negative logic input that enables the module output. This pin is TTL compatible and referenced to -V<sub>in</sub>. A logic '0' at this pin enables the module's outputs. A logic '1' or high impedance disables the module's outputs. If not used, the pin must be connected to -V<sub>in</sub>.

**EN 2:** The positive logic input that enables the module output. This pin is TTL compatible and referenced to -V<sub>in</sub>. A logic '1' or high impedance enables the module's outputs. If not used, the pin should be left open circuit.

**TEMP:** This pin produces an output signal that tracks the module's metal case temperature. The output voltage is referenced to -V<sub>in</sub> and rises approximately 10mV/°C from an initial value of 0.1VDC at -40°C ( $V_{TEMP} = 0.5 + 0.01 \cdot T_{Case}$ ). The signal is available whenever the module is supplied with a valid input

voltage, and is independent of the enable logic status. (**Note:** A load impedance of less than 1MΩ will adversely affect the module's over-temperature shutdown threshold. Use a high-impedance input when monitoring this signal.)

**AUX:** Produces a regulated output voltage of 11.6V ±5%, which is referenced to -V<sub>in</sub>. The current drawn from the pin must be limited to 10mA. The voltage may be used to indicate the output status of the module to a primary referenced circuit, or power a low-current amplifier.

**Vo<sub>1</sub>:** The higher regulated output voltage, which is referenced to the COM node.

**Vo<sub>2</sub>:** The lower regulated output voltage, which is referenced to the COM node.

**COM:** The secondary return reference for the module's two regulated output voltages. It is DC isolated from the input supply pins.

**Vo<sub>1</sub> Adjust:** Using a single resistor, this pin allows Vo<sub>1</sub> to be adjusted higher or lower than the preset value. If not used, this pin should be left open circuit.

**Vo<sub>2</sub> Adjust:** Using a single resistor, this pin allows Vo<sub>2</sub> to be adjusted higher or lower than the preset value. If not used, this pin should be left open circuit.

# PT4680 Series

## 20-A 24-V Input Dual Output Isolated DC/DC Converter

### Specifications (Unless otherwise stated, $T_a = 25^\circ\text{C}$ , $V_{in} = 24\text{V}$ , & $I_{O1} = I_{O2} = 10\text{A}$ )

Characteristics	Symbols	Conditions	PT4680 SERIES			Units	
			Min	Typ	Max		
Output Current	$I_{O1}$	Total (both outputs)	$V_{O1}$	0	—	15	A
	$I_{O2}$		$V_{O2}$	0	—	15	
	$I_{O1} + I_{O2}$		0	—	20 (1)		
Input Voltage Range	$V_{in}$			18	24	36	V
Set Point Voltage Tolerance	$V_{o,tol}$			—	$\pm 1$	$\pm 2$	$\%V_o$
Temperature Variation	$\Delta\text{Reg}_{temp}$	-40 to +100°C Case, $I_{O1} = I_{O2} = 0\text{A}$		—	$\pm 0.5$	—	$\%V_o$
Line Regulation	$\Delta\text{Reg}_{line}$	Over $V_{in}$ range with $I_{O1} = I_{O2} = 5\text{A}$		—	$\pm 5$	$\pm 10$	mV
Load Regulation	$\Delta\text{Reg}_{load}$	1A $\leq I_{O1} \leq 15\text{A}$ , $I_{O2} = 1\text{A}$ 1A $\leq I_{O2} \leq 15\text{A}$ , $I_{O1} = 1\text{A}$	$\Delta V_{O1}$	—	$\pm 2$	$\pm 10$	mV
			$\Delta V_{O2}$	—	$\pm 2$	$\pm 10$	
Cross Regulation	$\Delta\text{Reg}_{cross}$	1A $\leq I_{O2} \leq 15\text{A}$ , $I_{O1} = 1\text{A}$ 1A $\leq I_{O1} \leq 15\text{A}$ , $I_{O2} = 1\text{A}$	$\Delta V_{O1}$	—	$\pm 2$	$\pm 10$	mV
			$\Delta V_{O2}$	—	$\pm 2$	$\pm 5$	
Total Output Variation	$\Delta V_{o,tol}$	Includes set-point, line load, -40°C to +100°C case	$\Delta V_{O1}$	—	$\pm 2$	$\pm 3$	$\%V_o$
			$\Delta V_{O2}$	—	$\pm 2$	$\pm 3$	
Efficiency	$\eta$	$I_{O1} = I_{O2} = 10\text{A}$	PT4681	—	88	—	%
			PT4682	—	87	—	
			PT4683	—	87	—	
			PT4685	—	86	—	
			PT4686	—	85	—	
			PT4687	—	86	—	
$V_o$ Ripple (pk-pk)	$V_r$	$I_{O1} = I_{O2} = 5\text{A}$ , 20MHz bandwidth	$V_o = 5\text{V}$ $V_o < 5\text{V}$	— —	— —	75 50	mV <sub>pp</sub>
Transient Response	$t_{tr}$	1A/ $\mu\text{s}$ load step from 50% to 100% $I_{Omax}$ (either output)		—	25 6.0	100 —	$\mu\text{Sec}$ $\%V_o$
Current Limit	$I_{lim}$	Each output with other unloaded		15.5	18	—	A
Output Rise Time	$V_{on}$	At turn-on to within 90% of $V_o$		—	5	10	mSec
Output Over-Voltage Protection	OVP	Either output; shutdown and latch off		—	125 (2)	—	$\%V_o$
Switching Frequency	$f_s$			280	—	320	kHz
Under-Voltage-Lockout	UVLO	Rising Falling		—	17	18	V
				15	16	—	
Internal Input Capacitance	$C_{in}$			—	2	—	$\mu\text{F}$
On/Off Control		Referenced to $-V_{in}$					
Input High Voltage	$V_{IH}$			3.5	—	—	V
Input Low Voltage	$V_{IL}$			0	—	0.8 (3)	
Input Low Current	$I_{IL}$			—	0.5	—	mA
Quiescent Current	$I_{in}$ standby	Pins 2, 3, & 4 connected		—	3	5	mA
External Output Capacitance	$C_{out}$	Per each output		0	—	5,000	$\mu\text{F}$
Primary/Secondary Isolation	$V_{iso}$			1500	—	—	V
	$C_{iso}$			—	1500	—	pF
	$R_{iso}$			10	—	—	M $\Omega$
Temperature Sense	$V_{temp}$	Output voltage at temperatures:-	-40°C	—	0.1 (4)	—	V
			100°C	—	1.5 (4)	—	
Over-Temperature Shutdown	OTP	Case temperature (auto restart)		—	110	—	°C
Operating Temperature Range	$T_a$	Over $V_{in}$ range		-40	—	+85 (5)	°C
Storage Temperature	$T_s$	—		-40	—	+125	°C
Mechanical Shock	—	Per Mil-STD-883D, Method 2002.3		—	500	—	G's
Mechanical Vibration Per Mil-STD-883D, 20–2,000Hz	—	Vertical Horizontal		—	10 (6)	—	G's
				—	20 (6)	—	
Weight	—	—		—	90	—	grams
Flammability	—	Materials meet UL 94V-0					

**Notes:** (1) The sum-total current from  $V_{O1}$  &  $V_{O2}$  must not exceed 20ADC.

(2) This is a fixed parameter. Adjusting  $V_{O1}$  or  $V_{O2}$  higher will increase the module's sensitivity to over-voltage detection. For more information, see the application note on output voltage adjustment.

(3) The  $EN_1$  and  $EN_2$  control inputs (pins 3 & 4) have internal pull-ups and may be controlled with an open-collector (or open-drain) transistor. Both inputs are diode protected and can be connected to  $+V_{in}$ . The maximum open-circuit voltage is 5.4V.

(4) Voltage output at "TEMP" pin is defined by the equation:  $V_{TEMP} = 0.5 + 0.01 \cdot T$ , where  $T$  is in °C. See pin descriptions for more information.

(5) See SOA curves or consult the factory for the appropriate derating.

(6) The case pins on the through-boled package types (suffixes N & A) must be soldered. For more information see the applicable package outline drawing.

PT4681 ( $V_{o1}/V_{o2} = 5.0V/3.3V$ );  $V_{in} = 24V$  (See Notes A & B)

Efficiency vs  $I_{o1}$ ;  $I_{o2}$  @1A, 3A, and 6A

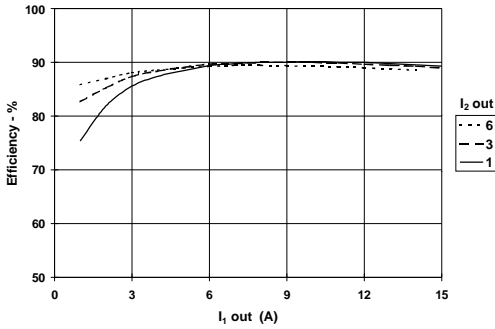

Power Dissipation vs  $I_{o1}$  and  $I_{o2}$

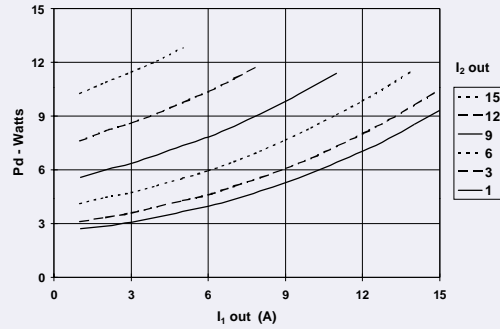

Efficiency vs  $I_{o1}$ ;  $I_{o2}$  @9A, 12A, and 15A

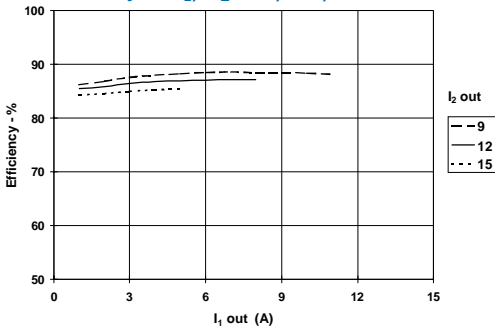

Safe Operating Area: ( $I_{o1} + I_{o2}$ )

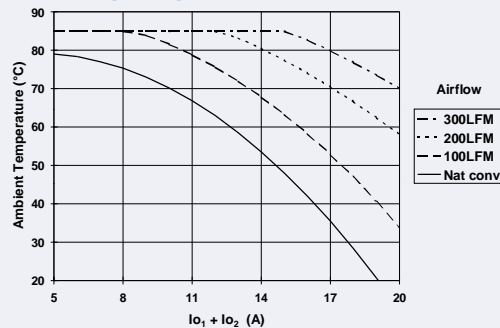

Cross Regulation:  $V_{o1}$  vs  $I_{o2}$  @ $I_{o1} = 1A$

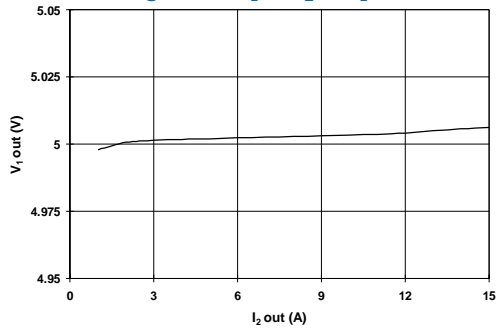

Cross Regulation:  $V_{o2}$  vs  $I_{o1}$  @ $I_{o2} = 1A$

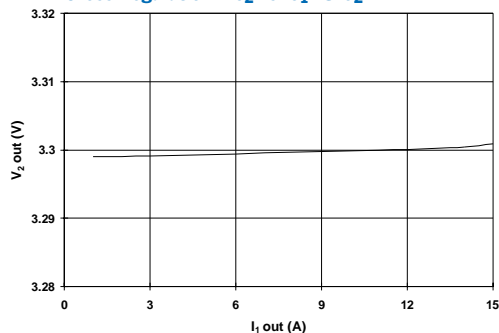

**Note A:** All Characteristic data in the above graphs has been developed from actual products tested at 25°C. This data is considered typical data for the converter.  
**Note B:** SOA curves represent operating conditions at which internal components are at or below manufacturer's maximum rated operating temperatures.

20-A 24-V Input Dual Output  
Isolated DC/DC Converter

PT4682 ( $V_{o1}/V_{o2} = 3.3V/2.5V$ );  $V_{in} = 24V$  (See Notes A & B)

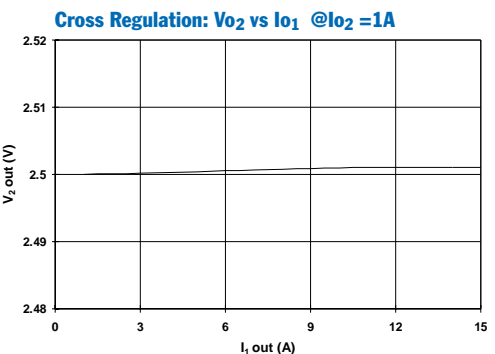
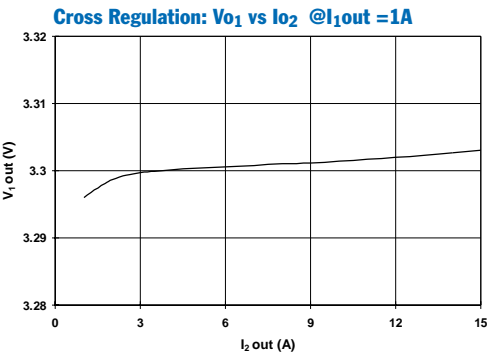
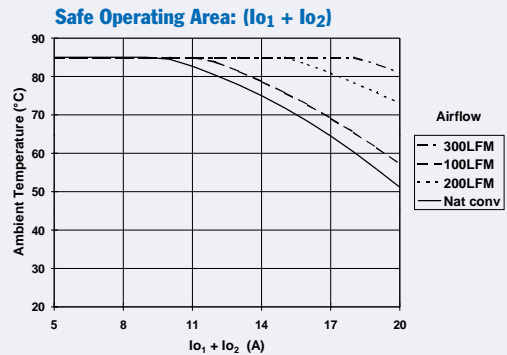
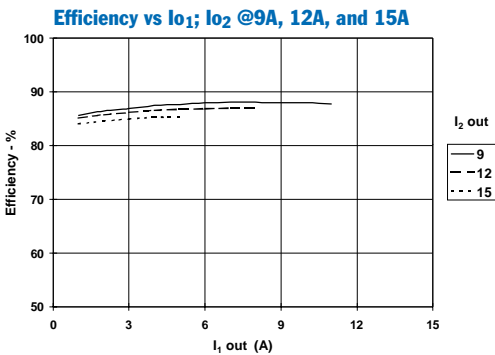
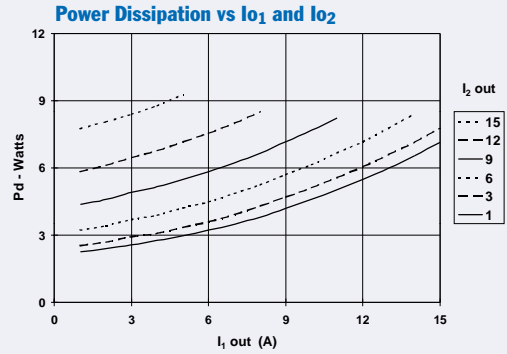
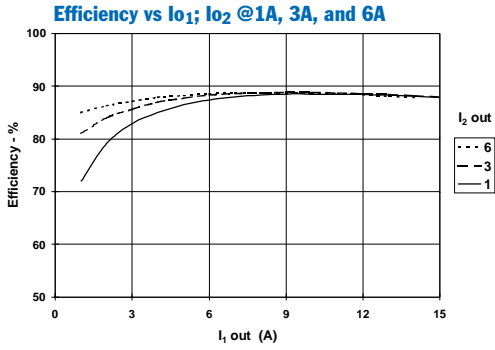

**Note A:** All Characteristic data in the above graphs has been developed from actual products tested at 25°C. This data is considered typical data for the converter.  
**Note B:** SOA curves represent operating conditions at which internal components are at or below manufacturer's maximum rated operating temperatures.

PT4683 ( $V_{o1}/V_{o2} = 3.3V/1.8V$ );  $V_{in} = 24V$  (See Notes A & B)

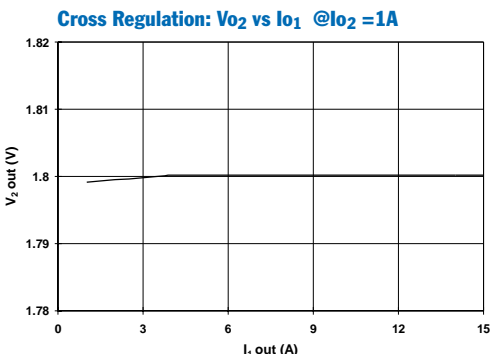
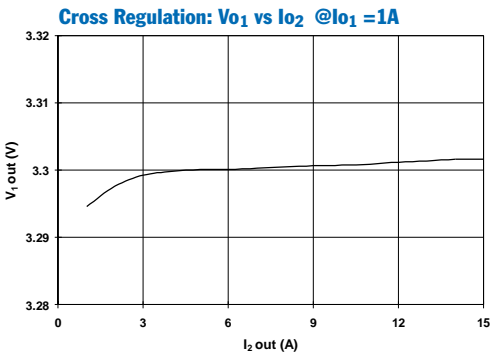
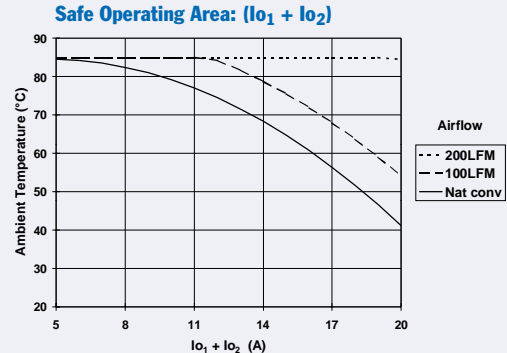
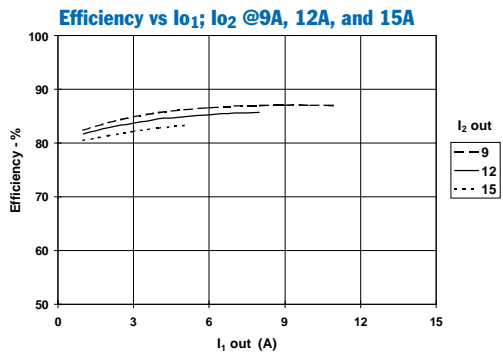
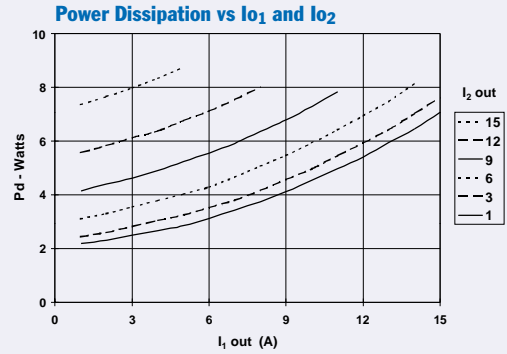
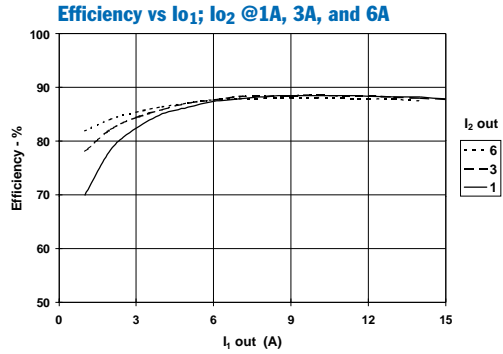

**Note A:** All Characteristic data in the above graphs has been developed from actual products tested at 25°C. This data is considered typical data for the converter.  
**Note B:** SOA curves represent operating conditions at which internal components are at or below manufacturer's maximum rated operating temperatures.

20-A 24-V Input Dual Output Isolated DC/DC Converter

PT4685 ( $V_{o1}/V_{o2} = 3.3V/1.5V$ );  $V_{in} = 24V$

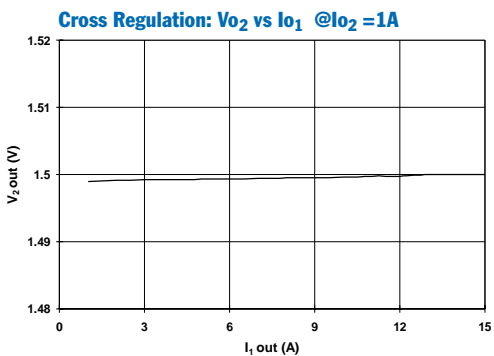
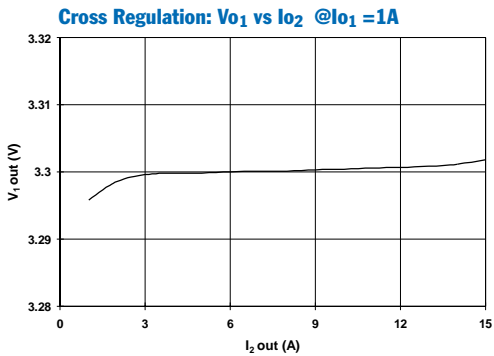
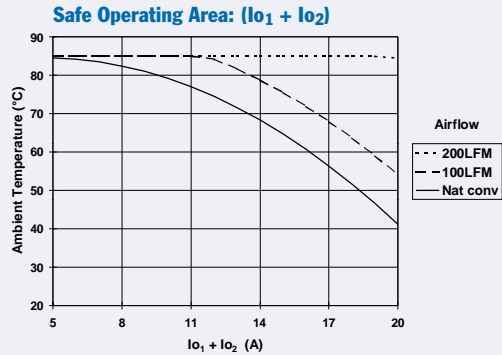
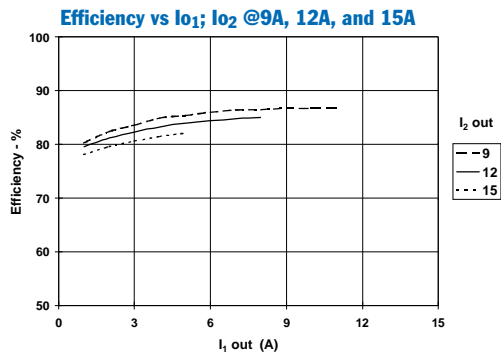
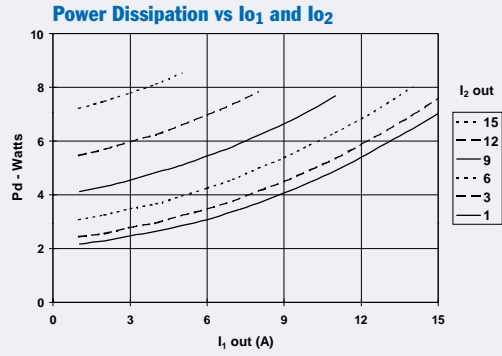
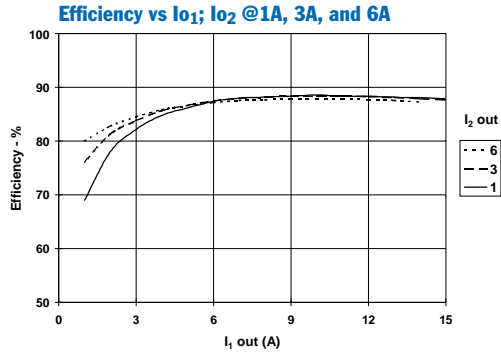

**Note A:** All Characteristic data in the above graphs has been developed from actual products tested at 25°C. This data is considered typical data for the converter.  
**Note B:** SOA curves represent operating conditions at which internal components are at or below manufacturer's maximum rated operating temperatures.

20-A 24-V Input Dual Output  
Isolated DC/DC Converter

PT4686 ( $V_{o1}/V_{o2} = 2.5V/1.8V$ );  $V_{in} = 24V$

Efficiency vs  $I_{o1}$ ;  $I_{o2}$  @1A, 3A, and 6A

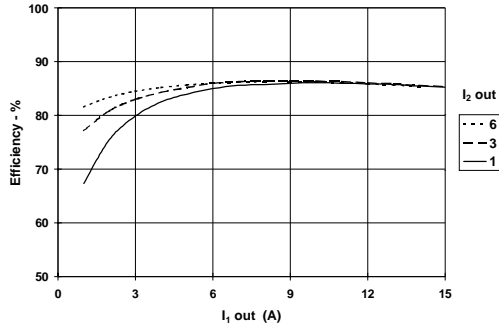

Power Dissipation vs  $I_{o1}$  and  $I_{o2}$

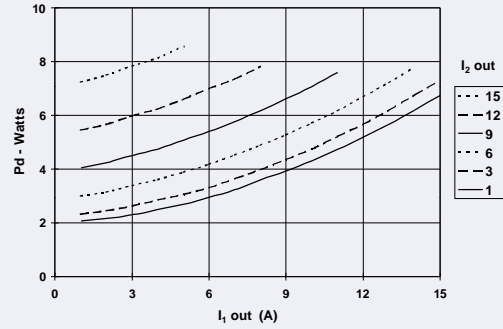

Efficiency vs  $I_{o1}$ ;  $I_{o2}$  @9A, 12A, and 15A

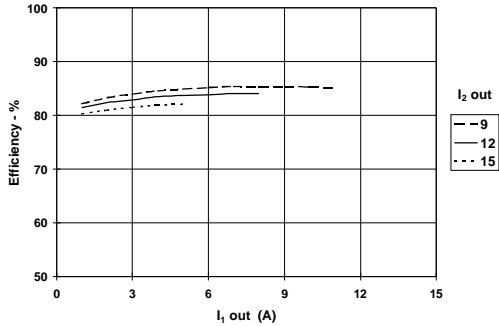

Safe Operating Area: ( $I_{o1} + I_{o2}$ )

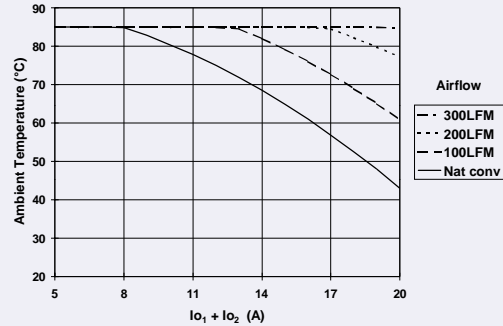

Cross Regulation:  $V_{o1}$  vs  $I_{o2}$  @ $I_{o1} = 1A$

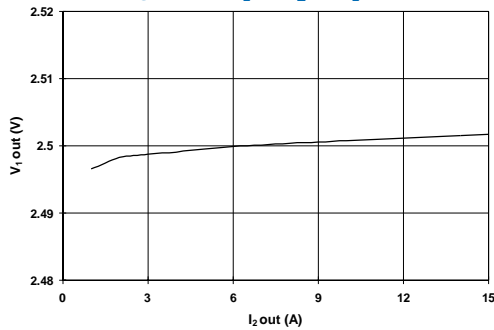

Cross Regulation:  $V_{o2}$  vs  $I_{o1}$  @ $I_{o2} = 1A$

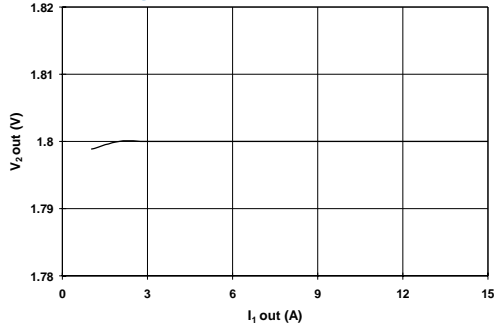

**Note A:** All Characteristic data in the above graphs has been developed from actual products tested at 25°C. This data is considered typical data for the converter.  
**Note B:** SOA curves represent operating conditions at which internal components are at or below manufacturer's maximum rated operating temperatures.

20-A 24-V Input Dual Output  
Isolated DC/DC Converter

PT4687 ( $V_{O1}/V_{O2} = 5V/1.8V$ );  $V_{in} = 24V$

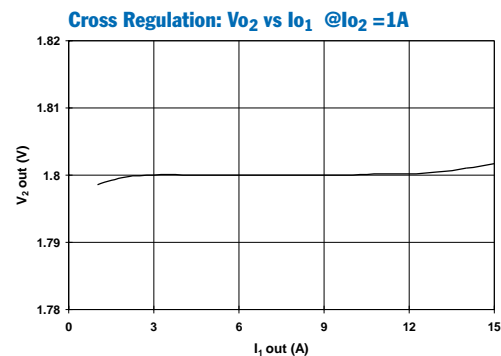
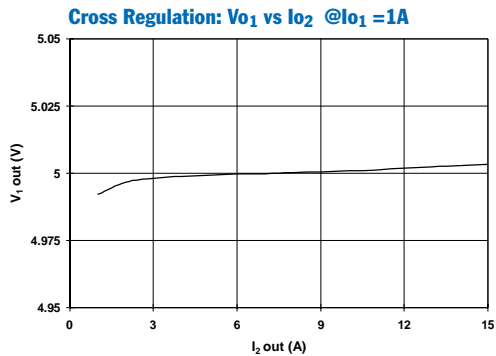
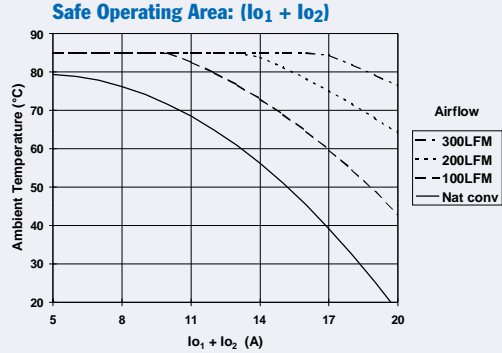
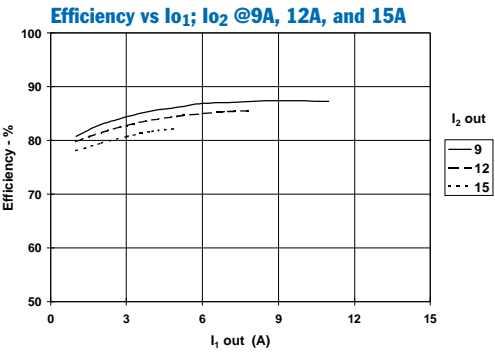
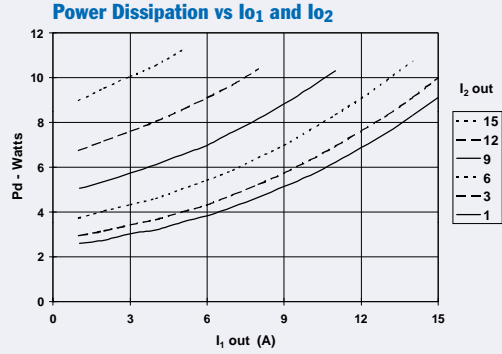
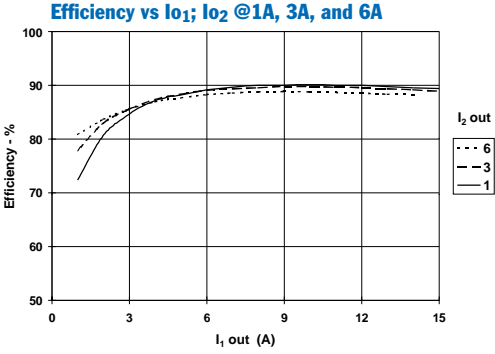

**Note A:** All Characteristic data in the above graphs has been developed from actual products tested at 25°C. This data is considered typical data for the converter.  
**Note B:** SOA curves represent operating conditions at which internal components are at or below manufacturer's maximum rated operating temperatures.

### Operating Features & System Considerations for the PT4660/PT4680 Dual-Output DC/DC Converters

#### Over-Current Protection

The dual-outputs of the PT4660 and PT4680 series of DC/DC converters have independent output voltage regulation and current limit control. Applying a load current in excess of the current limit threshold at either output will cause the respective output voltage to drop. However, the voltage at  $V_{O2}$  is derived from  $V_{O1}$ . Therefore a current limit fault on  $V_{O1}$  will also cause  $V_{O2}$  to drop. Conversely, a current limit fault applied to  $V_{O2}$  will only cause  $V_{O2}$  voltage to drop, and  $V_{O1}$  will remain in regulation.

The current limit circuitry incorporates a limited amount of foldback. The fault current flowing into an absolute short circuit is therefore slightly less than the current limit threshold. Recovery from a current limit fault is automatic and the converter will not be damaged by a continuous short circuit at either output.

#### Output Over-Voltage Protection

Each output is monitored for over voltage (OV). For fail safe operation and redundancy, the OV fault detection circuitry uses a separate reference to the voltage regulation circuits. The OV threshold is fixed, and set nominally 25% higher than the set-point output voltage. If either output exceeds the threshold, the converter is shutdown and must be actively reset. The OV protection circuit can be reset by momentarily turning the converter off. This is accomplished by either cycling one of the output enable control pins (EN1 or EN2), or by removing the input power to the converter. *Note: If  $V_{O1}$  or  $V_{O2}$  is adjusted to a higher voltage, the margin between the respective steady-state output voltage and its OV threshold is reduced. This can make the module sensitive to OV fault detection, that may result from random noise and load transients.*

#### Over-Temperature Protection

The PT4660/80 DC/DC converters have an internal temperature sensor, which monitors the temperature of the module's metal case. If the case temperature exceeds a nominal 115°C the converter will shut down. The converter will automatically restart when the sensed temperature returns to about 100°C. The analog voltage generated by the sensor is also made available at the 'TEMP' output (pin 5), and can be monitored by the host system for diagnostic purposes. Consult the 'Pin Descriptions' section of the data sheet for further information on this feature.

#### Under-Voltage Lock-Out

The Under-Voltage Lock-Out (UVLO) circuit prevents operation of the converter whenever the input voltage to the module is insufficient to maintain output regulation. The UVLO has approximately 2V of hysteresis. This is to prevent oscillation with a slowly changing input voltage. Below the UVLO threshold the module is off and the enable control inputs, EN1 and EN2 are inoperative.

#### Primary-Secondary Isolation

The PT4660/80 series of DC/DC converters incorporate electrical isolation between the input terminals (primary) and the output terminals (secondary). All converters are production tested to a withstand voltage of 1500VDC. The isolation complies with UL60950 and EN60950, and the requirements for operational isolation. This allows the converter to be configured for either a positive or negative input voltage source.

The regulation control circuitry for these modules is located on the secondary (output) side of the isolation barrier. Control signals are passed between the primary and secondary sides of the converter via a proprietary magnetic coupling scheme. This eliminates the use of opto-couplers. The data sheet 'Pin Descriptions' and 'Pin-Out Information' provides guidance as to which reference (primary or secondary) that must be used for each of the external control signals.

#### Fuse Recommendations

If desired an input fuse may be added to protect against the application of a reverse input voltage.

### Using the On/Off Enable Controls on the PT4660 and PT4680 Series of DC/DC Converters

The PT4660 (48V input) and PT4680 (24V input) series of 75-W dual-output DC/DC converters incorporates both positive and negative logic *Output Enable* controls. EN1 (pin 3) is the positive enable input, and EN2 (pin 4) is the negative enable input. Both inputs are TTL logic compatible, and are electrically referenced to  $-V_{in}$  (pin 2) on the primary (input) side of the converter. A pull-up resistor is not required, but may be added if desired. Adding a pull-up resistor from either input, up to  $+V_{in}$ , will not damage the converter.

#### Automatic (UVLO) Power-Up

Connecting EN1 (pin 3) to  $-V_{in}$  (pin 2) and leaving EN2 (pin 4) open-circuit configures the converter for automatic power up. (See data sheet “Typical Application”). The converter control circuitry incorporates an “Under Voltage Lockout” (UVLO) function, which disables the converter until the minimum specified input voltage is present at  $\pm V_{in}$ . (See data sheet Specifications). The UVLO circuitry ensures a clean transition during power-up and power-down, allowing the converter to tolerate a slow-rising input voltage. For most applications EN1 and EN2, can be configured for automatic power-up.

#### Positive Output Enable (Negative Inhibit)

To configure the converter for a positive enable function, connect EN1 (pin 3) to  $-V_{in}$  (pin 2), and apply the system On/Off control signal to EN2 (pin 4). In this configuration, a logic ‘0’ ( $-V_{in}$  potential) applied to pin 4 disables the converter outputs. An example of this configuration is detailed in Figure 1.

**Figure 1; Positive Enable Configuration**

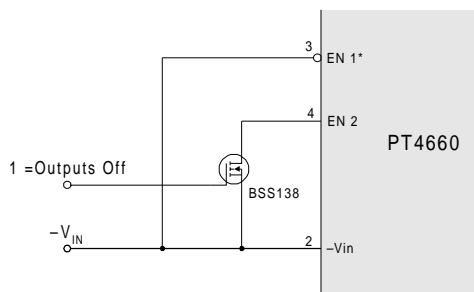

#### Negative Output Enable (Positive Inhibit)

To configure the converter for a negative enable function, EN2 (pin 4) is left open circuit, and the system On/Off control signal is applied to EN1 (pin 3). A logic ‘0’ ( $-V_{in}$  potential) must then be applied to pin 3 in order to

enable the outputs of the converter. An example of this configuration is detailed in Figure 2. *Note: The converter will only produce and output voltage if a valid input voltage is applied to  $\pm V_{in}$ .*

**Figure 2; Negative Enable Configuration**

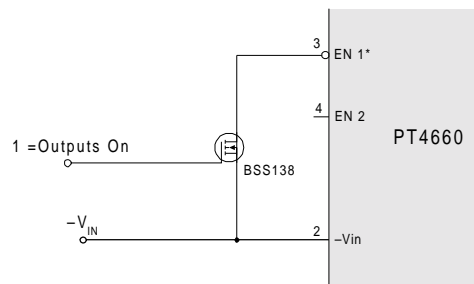

#### On/Off Output Voltage Sequencing

The output voltages from the PT4660 series of DC/DC converters are independently regulated, and are internally sequenced to meet the power-up requirements of popular microprocessor and DSP chipsets. Figure 3 shows the waveforms from a PT4661 after the converter is enabled at  $t=0$ s. During power-up, the  $V_{o1}$  and  $V_{o2}$  voltage waveforms typically track within 0.4V prior to  $V_{o2}$  reaching regulation. The waveforms were measured with a 5- $\text{A}_{dc}$  resistive load at each output, and with a 48-VDC input source applied. The converter typically produces a fully regulated output within 25ms. The actual turn-on time will vary slightly with input voltage, but the power-up sequence is independent of the load at either output.

**Figure 3;  $V_{o1}$ ,  $V_{o2}$  Power-Up Sequence**

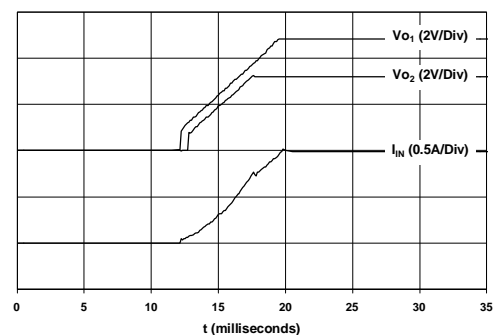

During turn-off, both outputs drop rapidly due to the discharging effect of actively switched rectifiers. The voltage at  $V_{o1}$  remains higher than  $V_{o2}$  during this period. The discharge time is typically 100 $\mu$ s, but will vary with the amount of external load capacitance.

## Adjusting the Output Voltage of the PT4660 and PT4680 Dual Output Voltage DC/DC Converters

The output voltages  $V_{O1}$  and  $V_{O2}$  from the PT4680 (24V Bus) and PT4660 (48V Bus) series of DC/DC converters can be independently adjusted higher or lower than the factory trimmed pre-set voltage by up to  $\pm 10\%$ . The adjustment requires the addition of a single external resistor<sup>1</sup>. Table 1 gives the adjustment range of  $V_{O1}$  and  $V_{O2}$  for each model in the series as  $V_a(\text{min})$  and  $V_a(\text{max})$ .

**$V_{O1}$  Adjust Down:** Add a resistor ( $R_1$ ), between pin 13 ( $V_1$  Adj) and pin 12 ( $V_{O1}$ )<sup>2</sup>.

**$V_{O1}$  Adjust Up:** To increase the output, add a resistor  $R_2$  between pin 13 ( $V_1$  Adj) and pin 14 (COM)<sup>2, 4</sup>.

**$V_{O2}$  Adjust Down:** Add a resistor ( $R_3$ ) between pin 20 ( $V_2$  Adj) and pin 21 ( $V_{O2}$ )<sup>2</sup>.

**$V_{O2}$  Adjust Up:** Add a resistor  $R_4$  between pin 20 ( $V_2$  Adj) and pin 19 (COM)<sup>2, 4</sup>.

Refer to Figure 1 and Table 2 for both the placement and value of the required resistor.

### Notes:

- Adjust resistors are not required if  $V_{O1}$  and  $V_{O2}$  are to remain at their respective nominal set-point voltage. In this case,  $V_1$  Adj (pin 13) and  $V_2$  Adj (pin 20) are left open-circuit
- Use only a single 1% resistor in either the ( $R_1$ ) or  $R_2$  location to adjust  $V_{O1}$ , and in the ( $R_3$ ) or  $R_4$  location to adjust  $V_{O2}$ . Place the resistor as close to the DC/DC converter as possible.

- $V_{O2}$  must always be at least 0.3V lower than  $V_{O1}$ .
- The over-voltage protection** threshold is fixed, and is set nominally 25% above the set-point output voltage. Adjusting  $V_{O1}$  or  $V_{O2}$  higher will reduce the voltage margin between the respective steady-state output voltage and its over-voltage (OV) protection threshold. This could make the module sensitive to OV fault detection, as a result of random noise and load transients.  
*Note: An OV fault is a latched condition that shuts down both outputs of the converter. The fault can only be cleared by cycling one of the Enable control pins ( $EN_1^*$  /  $EN_2$ ), or by momentarily removing the input power to the module.*
- Never connect capacitors to either the  $V_{O1}$  Adjust or  $V_{O2}$  Adjust pins. Any capacitance added to these control pins will affect the stability of the respective regulated output.

The adjust up and adjust down resistor values can also be calculated using the following formulas. Be sure to select the correct formula parameter from Table 1 for the output and model being adjusted.

$$(R_1) \text{ or } (R_3) = \frac{K_o (V_a - V_r)}{V_r (V_o - V_a)} - R_s \quad \text{k}\Omega$$

$$R_2 \text{ or } R_4 = \frac{K_o}{V_a - V_o} - R_s \quad \text{k}\Omega$$

Where:  $V_o$  = Original output voltage, ( $V_{O1}$  or  $V_{O2}$ )  
 $V_a$  = Adjusted output voltage  
 $V_r$  = The reference voltage from Table 1  
 $K_o$  = The multiplier constant in Table 1  
 $R_s$  = The series resistance from Table 1

Figure 1

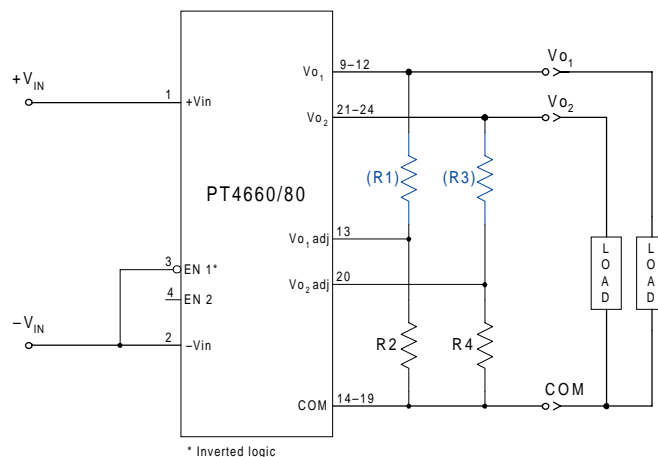

PT4660 & PT4680 Series

**Table 1; ADJUSTMENT RANGE AND FORMULA PARAMETERS**

Vo1 Bus					Vo2 Bus (2)				
24V Bus Pt.#	PT4681/7	PT4682/3/5	PT4688	PT4686	PT4681	PT4682	PT4683/6/7	PT4685	PT4688
48V Bus Pt.#	PT4661/7	PT4662/3/5	PT4668	PT4666	PT4661	PT4662	PT4663/6/7	PT4665	PT4668
Adj. Resistor	(R1)/R2	(R1)/R2	(R1)/R2	(R1)/R2	(R3)/R4	(R3)/R4	(R3)/R4	(R3)/R4	(R3)/R4
V <sub>o</sub> (nom)	5.0V	3.3V	3.3V	2.5V	3.3V	2.5V	1.8V	1.5V	1.2V
V <sub>a</sub> (min)	4.5V	2.97V	2.97V	2.25V	2.97V	2.25V	1.62V	1.35	1.08
V <sub>a</sub> (max)	5.5V	3.63V	3.63V	2.75V	3.63V	2.75V	1.98V	1.65	1.32
V <sub>r</sub>	2.5V	1.65V	2.5V	1.25	1.5V	1.5V	1.5V	TBD	0.6V
K <sub>o</sub> (V·kΩ)	1.248	8.234	10.96	6.24	1.8	2.0	1.9	TBD	0.726
R <sub>s</sub> (kΩ)	20.0	20.0	4.99	20.0	4.99	3.32	3.32	TBD	4.22

**Table 2A; ADJUSTMENT RESISTOR VALUES, Vo1**

24V Bus Pt.#	PT4681/7	PT4682/3/5	PT4688	PT4686		
48V Bus Pt.#	PT4661/7	PT4662/3/5	PT4668	PT4666		
Adj. Resistor	(R1)/R2	(R1)/R2	(R1)/R2	(R1)/R2		
V <sub>o</sub> (nom)	5.0V	3.3V	3.3V	2.5V		
V <sub>a</sub> (req'd)		V <sub>a</sub> (req'd)		V <sub>a</sub> (req'd)		
5.5	5.0kΩ	3.6	7.4kΩ	31.5kΩ	2.75	5.0kΩ
5.4	11.2kΩ	3.54	14.3kΩ	40.7kΩ	2.7	11.2kΩ
5.3	21.6kΩ	3.48	25.7kΩ	55.9kΩ	2.65	21.6kΩ
5.2	42.4kΩ	3.42	48.6kΩ	86.3kΩ	2.6	42.4kΩ
5.1	105.0kΩ	3.36	117.0kΩ	178.0kΩ	2.55	105.0kΩ
5.0		3.3			2.5	
4.9	(99.8)kΩ	3.24	(112.0kΩ)	(49.1kΩ)	2.45	(99.8kΩ)
4.8	(37.4)kΩ	3.18	(43.6kΩ)	(19.9kΩ)	2.4	(37.4kΩ)
4.7	(16.6)kΩ	3.12	(20.8kΩ)	(10.1kΩ)	2.35	(16.6kΩ)
4.6	(6.2)kΩ	3.06	(9.3kΩ)	(5.2kΩ)	2.3	(6.2kΩ)
4.5	(0.0)	3.0	(2.5kΩ)	(2.3kΩ)	2.25	(0.0kΩ)

R<sub>1</sub>/R<sub>3</sub> = (Blue), R<sub>2</sub>/R<sub>4</sub> = Black

**Table 2B; ADJUSTMENT RESISTOR VALUES, Vo2**

24V Bus Pt.#	PT4681	PT4682	PT4683/6/7	PT4685	PT4688
48V Bus Pt.#	PT4661	PT4662	PT4663/6/7	PT4665	PT4668
Adj. Resistor	(R3)/R4	(R3)/R4	(R3)/R4	(R3)/R4	(R3)/R4
V <sub>o</sub> (nom)	3.3V	2.5V	1.8V	1.5V	1.2V
V <sub>a</sub> (req'd)			V <sub>a</sub> (req'd)		
3.6	1.0kΩ		1.95	9.4kΩ	
3.54	2.5kΩ		1.9	15.7kΩ	
3.48	5.0kΩ		1.85	34.7kΩ	
3.42	10.0kΩ		1.8		
3.36	25.0kΩ		1.75	(3.0)kΩ	
3.3			1.7		
3.24	(29.8)kΩ		1.65	TBD	
3.18	(11.8)kΩ		1.6	TBD	
3.12	(5.8)kΩ		1.55	TBD	
3.06	(2.8)kΩ		1.5		
3.0	(1.0)kΩ		1.45	(TBD)	
2.75		4.7kΩ	1.4	(TBD)	
2.7		6.7kΩ	1.35	(TBD)	
2.65		10.0kΩ	1.3		3.0kΩ
2.6		16.7kΩ	1.275		5.5kΩ
2.55		36.7kΩ	1.25		10.3kΩ
2.5			1.225		24.8kΩ
2.45		(22.0)kΩ	1.2		
2.4		(8.7)kΩ	1.175		(23.6)kΩ
2.35		(4.2)kΩ	1.15		(9.1)kΩ
2.3		(2.0)kΩ	1.125		(4.3)kΩ
2.25		(0.7)kΩ	1.1		(1.8)kΩ

R<sub>1</sub>/R<sub>3</sub> = (Blue), R<sub>2</sub>/R<sub>4</sub> = Black

**PACKAGING INFORMATION**

Orderable Device	Status <sup>(1)</sup>	Package Type	Package Drawing	Pins	Package Qty	Eco Plan <sup>(2)</sup>	Lead/ Ball Finish	MSL Peak Temp <sup>(3)</sup>	Samples (Requires Login)
PT4681A	NRND	SIP MODULE	EKA	26	6	TBD	Call TI	Level-1-215C-UNLIM	
PT4681C	OBSOLETE	SIP MODULE	EKC	26		TBD	Call TI	Call TI	
PT4682A	NRND	SIP MODULE	EKA	26	6	TBD	Call TI	Level-1-215C-UNLIM	
PT4685C	NRND	SIP MODULE	EKC	26	6	TBD	Call TI	Level-3-215C-168HRS	

<sup>(1)</sup> The marketing status values are defined as follows:

**ACTIVE:** Product device recommended for new designs.

**LIFEBUY:** TI has announced that the device will be discontinued, and a lifetime-buy period is in effect.

**NRND:** Not recommended for new designs. Device is in production to support existing customers, but TI does not recommend using this part in a new design.

**PREVIEW:** Device has been announced but is not in production. Samples may or may not be available.

**OBSOLETE:** TI has discontinued the production of the device.

<sup>(2)</sup> Eco Plan - The planned eco-friendly classification: Pb-Free (RoHS), Pb-Free (RoHS Exempt), or Green (RoHS & no Sb/Br) - please check <http://www.ti.com/productcontent> for the latest availability information and additional product content details.

**TBD:** The Pb-Free/Green conversion plan has not been defined.

**Pb-Free (RoHS):** TI's terms "Lead-Free" or "Pb-Free" mean semiconductor products that are compatible with the current RoHS requirements for all 6 substances, including the requirement that lead not exceed 0.1% by weight in homogeneous materials. Where designed to be soldered at high temperatures, TI Pb-Free products are suitable for use in specified lead-free processes.

**Pb-Free (RoHS Exempt):** This component has a RoHS exemption for either 1) lead-based flip-chip solder bumps used between the die and package, or 2) lead-based die adhesive used between the die and leadframe. The component is otherwise considered Pb-Free (RoHS compatible) as defined above.

**Green (RoHS & no Sb/Br):** TI defines "Green" to mean Pb-Free (RoHS compatible), and free of Bromine (Br) and Antimony (Sb) based flame retardants (Br or Sb do not exceed 0.1% by weight in homogeneous material)

<sup>(3)</sup> MSL, Peak Temp. -- The Moisture Sensitivity Level rating according to the JEDEC industry standard classifications, and peak solder temperature.

**Important Information and Disclaimer:** The information provided on this page represents TI's knowledge and belief as of the date that it is provided. TI bases its knowledge and belief on information provided by third parties, and makes no representation or warranty as to the accuracy of such information. Efforts are underway to better integrate information from third parties. TI has taken and continues to take reasonable steps to provide representative and accurate information but may not have conducted destructive testing or chemical analysis on incoming materials and chemicals. TI and TI suppliers consider certain information to be proprietary, and thus CAS numbers and other limited information may not be available for release.

In no event shall TI's liability arising out of such information exceed the total purchase price of the TI part(s) at issue in this document sold by TI to Customer on an annual basis.

## IMPORTANT NOTICE

Texas Instruments Incorporated and its subsidiaries (TI) reserve the right to make corrections, modifications, enhancements, improvements, and other changes to its products and services at any time and to discontinue any product or service without notice. Customers should obtain the latest relevant information before placing orders and should verify that such information is current and complete. All products are sold subject to TI's terms and conditions of sale supplied at the time of order acknowledgment.

TI warrants performance of its hardware products to the specifications applicable at the time of sale in accordance with TI's standard warranty. Testing and other quality control techniques are used to the extent TI deems necessary to support this warranty. Except where mandated by government requirements, testing of all parameters of each product is not necessarily performed.

TI assumes no liability for applications assistance or customer product design. Customers are responsible for their products and applications using TI components. To minimize the risks associated with customer products and applications, customers should provide adequate design and operating safeguards.

TI does not warrant or represent that any license, either express or implied, is granted under any TI patent right, copyright, mask work right, or other TI intellectual property right relating to any combination, machine, or process in which TI products or services are used. Information published by TI regarding third-party products or services does not constitute a license from TI to use such products or services or a warranty or endorsement thereof. Use of such information may require a license from a third party under the patents or other intellectual property of the third party, or a license from TI under the patents or other intellectual property of TI.

Reproduction of TI information in TI data books or data sheets is permissible only if reproduction is without alteration and is accompanied by all associated warranties, conditions, limitations, and notices. Reproduction of this information with alteration is an unfair and deceptive business practice. TI is not responsible or liable for such altered documentation. Information of third parties may be subject to additional restrictions.

Resale of TI products or services with statements different from or beyond the parameters stated by TI for that product or service voids all express and any implied warranties for the associated TI product or service and is an unfair and deceptive business practice. TI is not responsible or liable for any such statements.

TI products are not authorized for use in safety-critical applications (such as life support) where a failure of the TI product would reasonably be expected to cause severe personal injury or death, unless officers of the parties have executed an agreement specifically governing such use. Buyers represent that they have all necessary expertise in the safety and regulatory ramifications of their applications, and acknowledge and agree that they are solely responsible for all legal, regulatory and safety-related requirements concerning their products and any use of TI products in such safety-critical applications, notwithstanding any applications-related information or support that may be provided by TI. Further, Buyers must fully indemnify TI and its representatives against any damages arising out of the use of TI products in such safety-critical applications.

TI products are neither designed nor intended for use in military/aerospace applications or environments unless the TI products are specifically designated by TI as military-grade or "enhanced plastic." Only products designated by TI as military-grade meet military specifications. Buyers acknowledge and agree that any such use of TI products which TI has not designated as military-grade is solely at the Buyer's risk, and that they are solely responsible for compliance with all legal and regulatory requirements in connection with such use.

TI products are neither designed nor intended for use in automotive applications or environments unless the specific TI products are designated by TI as compliant with ISO/TS 16949 requirements. Buyers acknowledge and agree that, if they use any non-designated products in automotive applications, TI will not be responsible for any failure to meet such requirements.

Following are URLs where you can obtain information on other Texas Instruments products and application solutions:

### Products

Audio	<a href="http://www.ti.com/audio">www.ti.com/audio</a>
Amplifiers	<a href="http://amplifier.ti.com">amplifier.ti.com</a>
Data Converters	<a href="http://dataconverter.ti.com">dataconverter.ti.com</a>
DLP® Products	<a href="http://www.dlp.com">www.dlp.com</a>
DSP	<a href="http://dsp.ti.com">dsp.ti.com</a>
Clocks and Timers	<a href="http://www.ti.com/clocks">www.ti.com/clocks</a>
Interface	<a href="http://interface.ti.com">interface.ti.com</a>
Logic	<a href="http://logic.ti.com">logic.ti.com</a>
Power Mgmt	<a href="http://power.ti.com">power.ti.com</a>
Microcontrollers	<a href="http://microcontroller.ti.com">microcontroller.ti.com</a>
RFID	<a href="http://www.ti-rfid.com">www.ti-rfid.com</a>
RF/IF and ZigBee® Solutions	<a href="http://www.ti.com/lprf">www.ti.com/lprf</a>

### Applications

Communications and Telecom	<a href="http://www.ti.com/communications">www.ti.com/communications</a>
Computers and Peripherals	<a href="http://www.ti.com/computers">www.ti.com/computers</a>
Consumer Electronics	<a href="http://www.ti.com/consumer-apps">www.ti.com/consumer-apps</a>
Energy and Lighting	<a href="http://www.ti.com/energy">www.ti.com/energy</a>
Industrial	<a href="http://www.ti.com/industrial">www.ti.com/industrial</a>
Medical	<a href="http://www.ti.com/medical">www.ti.com/medical</a>
Security	<a href="http://www.ti.com/security">www.ti.com/security</a>
Space, Avionics and Defense	<a href="http://www.ti.com/space-avionics-defense">www.ti.com/space-avionics-defense</a>
Transportation and Automotive	<a href="http://www.ti.com/automotive">www.ti.com/automotive</a>
Video and Imaging	<a href="http://www.ti.com/video">www.ti.com/video</a>
Wireless	<a href="http://www.ti.com/wireless-apps">www.ti.com/wireless-apps</a>

TI E2E Community Home Page

[e2e.ti.com](http://e2e.ti.com)

Mailing Address: Texas Instruments, Post Office Box 655303, Dallas, Texas 75265  
Copyright © 2011, Texas Instruments Incorporated