



Features

- 6A Output Current
- Input Voltage Range: 10.8 V to 13.2 V
- 90% Efficiency
- Adjustable Output Voltage
- Standby Function
- Short Circuit Protection
- Small Footprint (0.61 in²)
- Solderable Copper Case
- 8.8 10⁶ Hours MTBF

Description

The PT6340 Excalibur™ power modules are a series of high performance Integrated Switching Regulators (ISRs), housed in a thermally efficient solderable copper case. These modules operate from a 12V input voltage bus to produce a high-output low-voltage power source; ideal for powering the industry's latest DSP and microprocessors. The series includes standard output bus voltages ranging from 5VDC to 1.2VDC.

The innovative copper case construction provides superior thermal performance in a small footprint. Both through-hole and surface mount pin configurations are available. The PT6340 series operating features include external output voltage adjustment, an On/Off inhibit, and short-circuit protection. A 100µF input, and 330µF output capacitor are required for proper operation.

Ordering Information

- PT6341□ = 5.0 Volts
 PT6342□ = 3.3 Volts
 PT6343□ = 2.5 Volts
 PT6344□ = 1.8 Volts
 PT6345□ = 1.5 Volts
 PT6346□ = 1.2 Volts

PT Series Suffix (PT1234x)

Case/Pin Configuration	Order Suffix	Package Code *
Vertical	N	(EPH)
Horizontal	A	(EPJ)
SMD	C	(EPK)

* Previously known as package styles 1540/50.
 (Reference the applicable package code drawing for the dimensions and PC board layout)

Pin-Out Information

Pin	Function
1	Inhibit *
2	V _{in}
3	V _{in}
4	V _{in}
5	GND
6	GND
7	GND
8	GND
9	V _{out}
10	V _{out}
11	V _{out}
12	V _{out} Adj *

* For further information, see application notes.

Standard Application

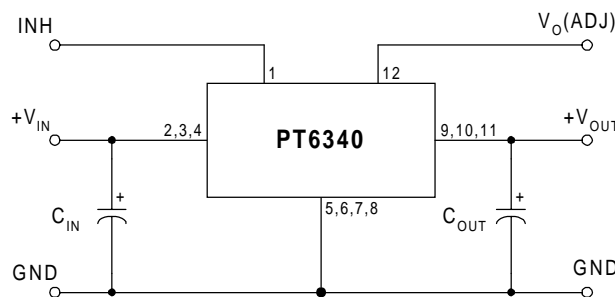

C_{in} = Required 100µF electrolytic
 C_{out} = Required 330µF electrolytic

Specifications (Unless otherwise stated, $T_a = 25^\circ\text{C}$, $V_{in} = 12\text{V}$, $C_{in} = 100\mu\text{F}$, $C_{out} = 330\mu\text{F}$, and $I_o = I_{o,max}$)

Characteristic	Symbol	Conditions	PT6340 SERIES			Units
			Min	Typ	Max	
Output Current	I_o	$T_a = +60^\circ\text{C}$, 200LFM $T_a = +25^\circ\text{C}$, natural convection	0.1 (1) 0.1 (1)	— —	6 6	A
Input Voltage Range	V_{in}	Over I_o Range	10.8	—	13.2	VDC
Set Point Voltage Tolerance	V_o tol		—	± 1	± 2	% V_o
Temperature Variation	Reg_{temp}	$-40^\circ \leq T_a \leq +85^\circ\text{C}$, $I_o = I_{o,min}$	—	± 0.5	—	% V_o
Line Regulation	Reg_{line}	Over V_{in} range	—	± 5	± 10	mV
Load Regulation	Reg_{load}	Over I_o range	—	± 5	± 15	mV
Total Output Voltage Variation	$\Delta V_{o,tot}$	Includes set-point, line, load, $-40^\circ \leq T_a \leq +85^\circ\text{C}$	—	± 2	± 3	% V_o
Efficiency	η	$I_o = 4\text{A}$	$V_o = 5.0\text{V}$ $V_o = 3.3\text{V}$ $V_o = 2.5\text{V}$ $V_o = 1.8\text{V}$ $V_o = 1.5\text{V}$ $V_o = 1.2\text{V}$	— 93 92 91 89 87 85	— — — — — —	%
V_o Ripple (pk-pk)	V_r	20MHz bandwidth	—	20	—	mV _{pp}
Transient Response	t_{tr}	1A/ μs load step, 50% to 100% $I_{o,max}$	—	50	—	μs
	ΔV_{tr}	V_o over/undershoot	—	± 60	—	mV
Short Circuit Threshold	I_{sc} threshold		—	8.5	—	A
Switching Frequency	f_s	Over V_{in} and I_o range	300	350	400	kHz
Inhibit (Pin 1)		Referenced to GND (pin 5)				
High-Level Input Voltage	V_{IH}		$V_{in} - 0.5$	—	Open (2)	V
Low-Level Input Voltage	V_{IL}		-0.2	—	+0.5	
Low-Level Input Current	I_{IL}		—	-0.5	—	mA
Standby Input Current	$I_{in, standby}$	pins 1 & 5 connected	—	+0.5	—	mA
External Output Capacitance	C_{out}	See application schematic	330	—	1,000	μF
External Input Capacitance	C_{in}	See application schematic	100	—	—	μF
Operating Temperature Range	T_a	Over V_{in} range	-40 (3)	—	+85 (4)	$^\circ\text{C}$
Storage Temperature	T_s	—	-40	—	+125	$^\circ\text{C}$
Reliability	MTBF	Per Bellcore TR-332 50% stress, $T_a = 40^\circ\text{C}$, ground benign	8.8	—	—	10 ⁶ Hrs
Mechanical Shock	—	Per Mil-Std-883D, method 2002.3, 1ms, half-sine, mounted to a fixture	—	500	—	G's
Mechanical Vibration	—	Mil-Std-883D, Method 2007.2, 20-2000Hz, soldered in PCB	—	20 (5)	—	G's
Weight	—		—	23	—	grams
Flammability	—	Materials meet UL 94V-0				

Notes: (1) The ISR will operate at no load with reduced specifications.

(2) The Inhibit control (pin 1) has an internal pull-up and if it is left open circuit the module will operate when input power is applied. The open-circuit voltage is the input voltage V_{in} . Use a discrete MOSFET to control the Inhibit pin, and ensure a transition time of less than $\leq 10\mu\text{s}$. Consult the related application note for other interface considerations.

(3) For operation below 0°C , C_{in} and C_{out} must have stable characteristics. Use either low ESR tantalum or Oscon® capacitors.

(4) See Safe Operating Area curves or contact the factory for the appropriate derating.

(5) The case pins on through-hole package types (suffixes N & A) must be soldered. For more information consult the applicable package outline drawing.

Input/Output Capacitors: The PT6340 regulator series requires a 100 μF electrolytic (or tantalum) capacitor at the input and 330 μF at the output for proper operation in all applications. In addition, the input capacitance, C_{in} , must be rated for a minimum of 740mA rms of ripple current, and the ESR of the output capacitor, C_{out} , must be less than 50m Ω @ 100kHz. For transient or dynamic load applications additional output capacitance may be necessary. For more information consult the related application note on capacitor recommendations.

6-A 12-V Input Adjustable Integrated Switching Regulator

PT6340 Series Performance; @ $V_{IN} = 12.0V$ (See Note A)

Safe Operating Area (See Note B)

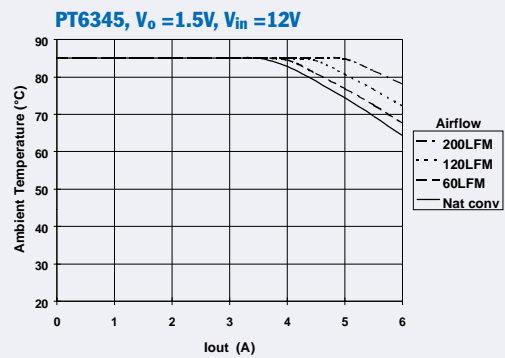
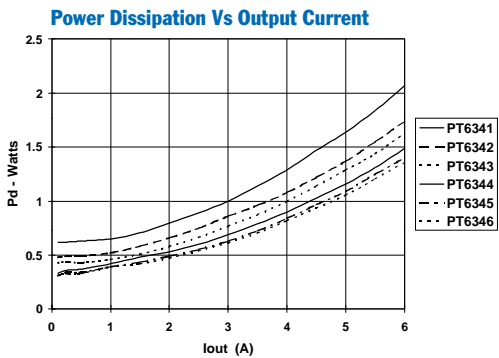
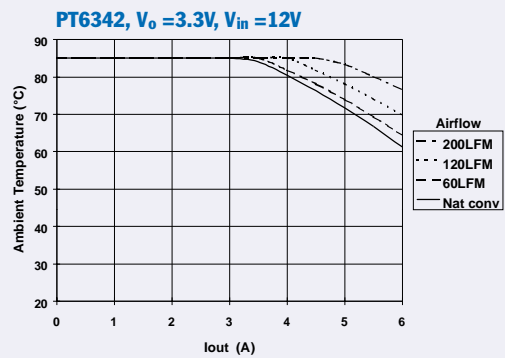
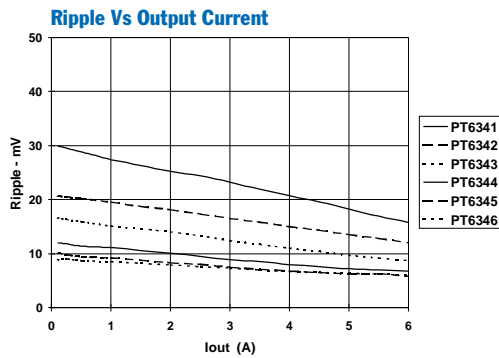
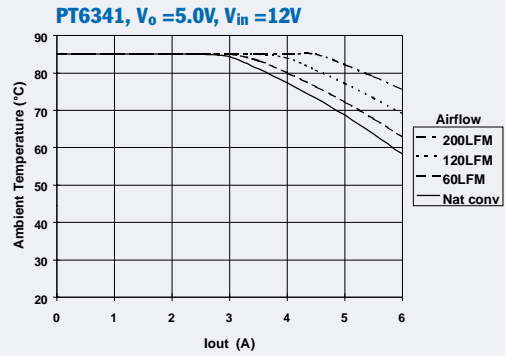
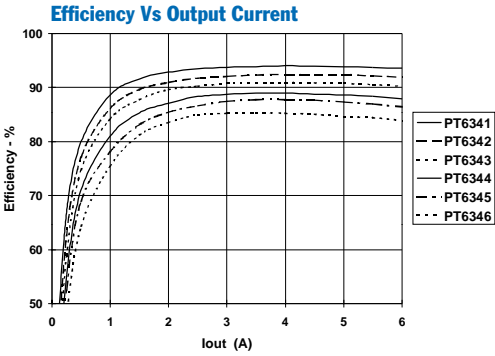

Note A: Characteristic data has been developed from actual products tested at 25°C. This data is considered typical data for the Converter.

Note B: SOA curves represent the conditions at which internal components are at or below the manufacturer's maximum operating temperatures

Using the Inhibit Function on the PT6340 12V Bus Excalibur™ Series Converters

The PT6340 series are high efficiency regulators that are designed to operate off a 12V input bus. These devices incorporate an inhibit function, which may be used in applications that require a power-up/shutdown feature.

The inhibit function is provided by the *Inhibit** control, pin 1. If pin 1 is left open-circuit the regulator operates normally, and provides a regulated output whenever a valid supply voltage is applied to V_{in} (pins 2–4) with respect to GND (pins 5–8). If a low voltage² is then applied to pin 1 the regulator output will be disabled and the input current drawn by the ISR will typically drop to 0.5mA⁴. The standby control may also be used to hold-off the regulator output during the period that input power is applied.

The *Inhibit** input can be controlled with an open-collector (or open-drain) discrete transistor (See Figure 1). The input is internally pulled-up to the input voltage, V_{in} ¹. Table 1 gives the control voltage requirements.

Table 1 Inhibit Control Requirements³

Parameter	Min	Typ	Max
V_{IL}	-0.1V		0.6V
V_{IH}	2.0V		V_{in}
I_{IL}		0.5mA	

Notes:

1. The inhibit control input requires no external pull-up resistor. The open-circuit voltage of the *Inhibit** input is typically the input voltage, V_{in} .
2. The inhibit control input is Not compatible with TTL devices. An open-collector device, preferably a discrete bipolar transistor (or MOSFET) is recommended. To ensure the regulator output is disabled, the control pin must be pulled to less than 0.6Vdc with a low-level 0.5mA sink to ground.
3. An external source voltage can be used to control the *Inhibit** pin. To guarantee the inhibit and enable status of the regulator, the source must be capable of meeting the voltage requirements in Table 1.
4. When the regulator output is disabled the current drawn from the input source is typically reduced to 0.5mA.

Figure 1

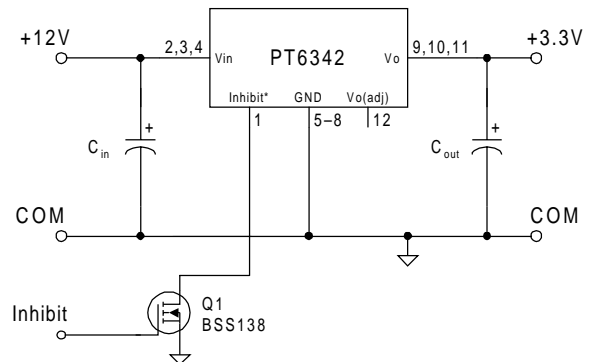

Turn-On Time: In the circuit of Figure 1, turning Q_1 on applies a low voltage to the *Inhibit** control (pin 1) and disables the regulator output. Correspondingly, turning Q_1 off removes the low-voltage signal and enables the output. Once enabled, the output will typically experience a 10–15ms delay followed by a predictable ramp-up of voltage. The regulator should provide a fully regulated output voltage within 30ms. The waveform of Figure 2 shows the output voltage response of a PT6342 (3.3V) following the turn-off of Q_1 . The turn off of Q_1 corresponds to the rise in V_{inh} . The waveforms were measured with a 12Vdc input voltage, and 2 ½ Adc load.

Figure 2

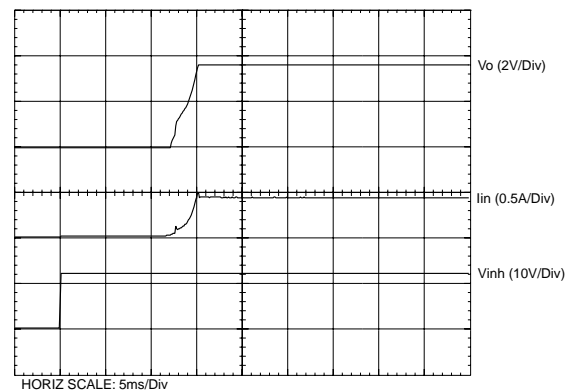

Capacitor Recommendations for the PT6340 6A Excalibur™ Regulator Series

Input Capacitors:

Output Current $\leq 4A$ Continuous (Table 1)

The recommended input capacitance is determined by 740 milli-amperes (rms) minimum ripple current rating, less than 100m Ω ESR (equivalent series resistance), and 100 μ F minimum capacitance. The ripple current rating, ESR, and operating temperature are the major considerations when selecting the input capacitor.

It is recommended that tantalum capacitors have a minimum voltage rating of twice (2 \times) the maximum dc voltage, plus the ac ripple. This is necessary to insure reliability with 12V input voltage bus applications. None of the 100 μ F tantalum capacitors were found to meet this requirement.

Input Capacitors:

Output Current $>4A$ Continuous (Table 2)

The recommended input capacitance is determined by 1.0 amperes (rms) minimum ripple current rating and 100 μ F minimum capacitance. The ripple current rating, combined with less than 100m Ω ESR (equivalent series resistance) value are the major considerations, along with temperature, when selecting the input capacitor.

It is recommended that tantalum capacitors have a minimum voltage rating of twice (2 \times) the maximum dc voltage, plus the ac ripple. This is necessary to insure reliability for 12V input voltage bus applications. None of the 100 μ F tantalum capacitors were found to meet this requirement.

Output Capacitors:

Output Current 0–6A (Table 1 & Table 2)

The ESR of the required capacitor must be less than, or equal to 50m Ω . Electrolytic capacitors have poor ripple performance at frequencies greater than 400kHz but excellent low frequency transient response. Above the ripple frequency, ceramic decoupling capacitors are necessary to improve the transient response and reduce any high frequency noise components apparent during higher current excursions. Preferred low ESR type capacitor's part numbers are identified in the capacitor tables.

Tantalum Capacitors

Tantalums are acceptable on the output bus but only the AVX TPS series, Sprague 593D/594/595 series or Kemet T495/T510 series. These capacitors are recommended over many other types due to their higher rated surge, power dissipation, and ripple current capability. As a caution, the TAJ series by AVX is not recommended. This series exhibits considerably higher ESR and lower ripple current capability. The TAJ series is also less reliable than the TPS series when determining power dissipation capability. Tantalum or Oscon capacitor types are recommended for applications where ambient temperatures fall below 0°C.

Capacitor Tables

Table 1 and Table 2 identify the vendors with acceptable ESR and maximum allowable ripple current (rms) ratings. The output capacitors are identified in both tables under the "Output Bus" column with the required quantity.

The input capacitors are listed in both tables. Table 1 has the recommended input capacitors when operating the ISR at a load current of 4Adc or less, and Table 2 identifies input capacitors for ISR load currents greater than 4Adc.

This is not an extensive capacitor list. Capacitors from other vendors are available with comparable specifications. Those listed are for guidance. The RMS ripple current rating and ESR (Equivalent Series Resistance at 100kHz) are critical parameters necessary to insure both optimum regulator performance and long capacitor life.

Table 1: Input/Output Capacitors (Output Current ≤4 Amperes Continuous)

Capacitor Vendor/ Component Series	Capacitor Characteristics					Quantity		Vendor Number
	Working Voltage	Value(µF)	(ESR) Equivalent Series Resistance	Max Ripple Current @85°C (Irms)	Physical Size (mm)	Input Bus	Output Bus	
Panasonic FC (Radial)	35V	220µF	0.09Ω +2	755mA	10 ×12.5	1	2	EEUF1V221
	35V	180µF	0.09Ω +2	755mA	10 ×12.5	1	2	EEUF1V181
	50V	680µF	0.048Ω	1835mA	16 ×20	1	1	EEUF1H681
FC (Surface Mount)	63V	220µF	0.09Ω +2	1410mA	16 ×16.5	1	2	EEVFC1J221N
	35V	330µF	0.12Ω +3	1205mA	12.5 ×16	1	3	EEVFC1V331LQ
	35V	470µF	0.043Ω	1690mA	16 ×16.5	1	1	EEVFC1V471N
United Chemi-Con, LXV/LXZ	50V	120µF	0.12Ω +3	755mA	10 ×16	1	3	LXV50VB121M10X16LL
	35V	220µF	0.09Ω +2	760mA	10 ×12.5	1	2	LXZ35VB221M10X12LL
FS	10V	330µF	0.025Ω	3500mA	10 ×10.5	N/R	1	10FS330M
	20V	150µF	0.03Ω +2	3200mA	10 ×10.5	1	2	20FS150M
Nichicon, PL	35V	560µF	0.048Ω	1360mA	16 ×15	1	1	UPL1V561MHH6
	35V	330µF	0.065Ω +2	1020mA	12.5 ×15	1	2	UPL1V331MHH6
PM	50V	470µF	0.046Ω	1470mA	18 ×15	1	1	UPM1H4711MHH6
Osccon, SS (Radial)	10V	330µF	0.025Ω	>3500mA	10.0 ×10.5	N/R	1	10SS330M
SV (Surface Mount)	10V	330µF	0.025Ω	>3800mA	10.3 ×10.3	N/R	1	10SV300M
	20V	150µF	0.024Ω +2	3600mA	10.3 ×10.3	1	2	20SV150M
AVX Tantalum TPS	10V	330µF	0.1Ω +2	>2500mA	7.3L	N/R	2	TPSV337M010R0100
	10V	330µF	0.1Ω +2	>3000mA	×4.3W	N/R	2	TPSV337M010R0060
	25V	68µF	0.095Ω	>2000mA	×4.1H	2	N/R	TPSV686M025R0095
Kemet, T510 T495	10V	330µF	0.033Ω	1400mA	7.3L ×5.7W	N/R	1	T510X337M010AS
	10V	220µF	0.07Ω +2	>2000mA	×4.0H	N/R	2	T495X227M010AS
Sprague, 594D	10V	330µF	0.045Ω	2350mA	7.3L ×6.0W	N/R	1	594D337X0010R2T
	25V	68µF	0.095Ω	1600mA	×4.1H	2	N/R	594D686X0025R2T

N/R –Not recommended. The voltage rating does not meet the minimim operating limits.

Table 2: Input/Output Capacitors (Output Current >4 Amperes Continuous)

Capacitor Vendor/ Component Series	Capacitor Characteristics					Quantity		Vendor Number
	Working Voltage	Value(µF)	(ESR) Equivalent Series Resistance	Max Ripple Current @85°C (Irms)	Physical Size (mm)	Input Bus	Output Bus	
Panasonic, FC (Radial)	35V	680µF	0.043Ω	1655mA	12.5 ×20	1	1	EEUF1V681
	35V	560µF	0.038Ω	1655mA	12.5 ×20	1	1	EEUF1V561S
	50V	680µF	0.048Ω	1835mA	16 ×20	1	1	EEUF1H681
FC (Surface Mount)	63V	220µF	0.09+2Ω	1410mA	16 ×16.5	1	2	EEVFC1J221N
	35V	330µF	0.12+3Ω	1205mA	12.5 ×16	1	3	EEVFC1V331LQ
	35V	470µF	0.043Ω	1690mA	16 ×16.5	1	1	EEVFC1V471N
United Chemi-con LXV/LXZ/ FX/FS	35V	330µF	0.068Ω	1050mA	10 ×16	1	2	LXZ35VB331M110X16LL
	25V	820µF	0.046Ω	1340mA	12 ×20	1	1	LXV25VB820M12X20LL
	10V	390µF	0.030Ω	3080mA	8 ×10.5	N/R	1	10FX390M
	20V	150µF	0.024Ω	3200mA	8 ×10.5	1	2	20FX150M
Nichicon, PL	35V	560µF	0.048Ω	1360mA	16 ×15	1	1	UPL1V561MHH6
	35V	330µF	0.06+2Ω	1020mA	12.5 ×15	1	2	UPL1V331MHH6
PM	35V	560µF	0.0048Ω	1360mA	16 ×15	1	1	UPM1V561MHH6
Osccon, SS (Radial)	10V	330µF	0.025Ω	>3500mA	10.0 ×10.5	N/R	1	10SS330M
SV (Surface Mount)	10V	330µF	0.025Ω	>3800mA	10.3 ×10.3	N/R	1	10SV330M
	20V	150µF	0.02+2Ω	3600mA	10.3 ×10.3	1	2	20SV150M
AVX Tantalum, TPS	10V	330µF	0.1+2Ω	>2500mA	7.3L	N/R	2	TPSV337M010R0100
	10V	330µF	0.1+2Ω	>3000mA	×4.3W	N/R	2	TPSV337M010R0060
	25V	68µF	0.095Ω	>2000mA	×4.1H	2	N/R	TPSV686M025R0095
Kemet, T510 T495	10V	330µF	0.033Ω	1400mA	7.3L ×5.7W	N/R	1	T510X337M010AS
	10V	220µF	0.07Ω+2	>2000mA	×4.0H	N/R	2	T495X227M010AS
Sprague, 594D	10V	330µF	0.045Ω	2350mA	7.3L ×6.0W	N/R	1	594D337X0010R2T
	25V	68µF	0.095Ω	1600mA	×4.1H	2	N/R	594D686X0025R2T

N/R –Not recommended. The voltage rating does not meet the minimim operating limits.

Adjusting the Output Voltage of the PT6340 Excalibur™ 6 A, 12 V Bus Step-Down ISRs

The output voltage of the PT6340 Series ISRs may be adjusted higher or lower than the factory trimmed pre-set voltage with the addition of a single external resistor. Table 1 accordingly gives the allowable adjustment range for each model for either series as V_a (min) and V_a (max).

Adjust Up: An increase in the output voltage is obtained by adding a resistor R_2 , between pin 12 (V_o adj) and pins 5-8 (GND).

Adjust Down: Add a resistor (R_1), between pin 12 (V_o adj) and pins 9-10-11 (V_o).

Figure 1

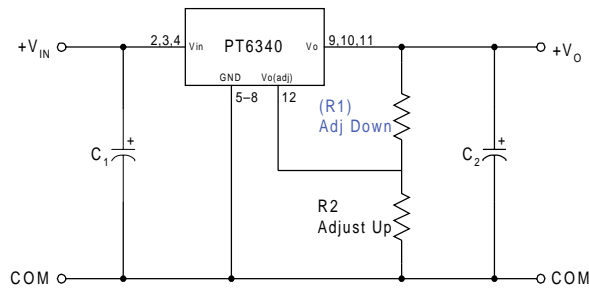

The values of (R_1) [adjust down], and R_2 [adjust up], can also be calculated using the following formulas. Refer to Figure 1 and Table 2 for both the placement and value of the required resistor; either (R_1) or R_2 as appropriate.

$$(R_1) = \frac{R_o (V_a - V_r)}{V_o - V_a} - R_s \quad \text{k}\Omega$$

$$R_2 = \frac{V_r \cdot R_o}{V_a - V_o} - R_s \quad \text{k}\Omega$$

Where: V_o = Original output voltage
 V_a = Adjusted output voltage
 V_r = Reference voltage (Table 1)
 R_o = Resistance constant (Table 1)
 R_s = Internal series resistance (Table 1)

Notes:

1. Use only a single 1% resistor in either the (R_1) or R_2 location. Place the resistor as close to the ISR as possible.
2. Never connect capacitors from V_o adj to either GND or V_{out} . Any capacitance added to the V_o adj pin will affect the stability of the ISR.

Table 1

ISR ADJUSTMENT RANGE AND FORMULA PARAMETERS						
Series Pt #	PT6341	PT6342	PT6343	PT6244	PT6345	PT6346
V_o (nom)	5.0	3.3	2.5	1.8	1.5	1.2
V_a (min)	4.0	2.8	2.2	1.7	1.45	1.1
V_a (max)	5.5	3.8	3.0	2.3	2.0	1.45
V_r (V)	1.27	1.27	1.27	1.27	1.27	0.8
R_o (k Ω)	10.0	10.0	10.0	10.0	10.0	10.0
R_s (k Ω)	24.9	24.9	24.9	24.9	24.9	24.9

Table 2

ISR ADJUSTMENT RESISTOR VALUES

Series Pt #	PT6343	PT6344	PT6345	PT6346	Series Pt #	PT6341	PT6342
V _o (nom)	2.5	1.8	1.5	1.2V	V _o (nom)	5.0	3.3V
V _a (req'd)					V _a (req'd)		
1.1				(5.1)kΩ	2.8		(5.7)kΩ
1.15				(45.1)kΩ	2.85		(10.2)kΩ
1.2					2.9		(15.8)kΩ
1.25				135.0kΩ	2.95		(22.9)kΩ
1.3				55.1kΩ	3.0		(32.8)kΩ
1.35				28.4kΩ	3.05		(46.3)kΩ
1.4				15.1kΩ	3.1		(66.6)kΩ
1.45			(11.1)kΩ	7.1kΩ	3.15		(100.0)kΩ
1.5					3.2		(168.0)kΩ
1.55			229.0kΩ		3.25		(371.0)kΩ
1.6			102.0kΩ		3.3		
1.65			59.8kΩ		3.35		229.0kΩ
1.7		(18.1)kΩ	38.6kΩ		3.4		102.0kΩ
1.75		(71.1)kΩ	25.9kΩ		3.45		59.8kΩ
1.8			17.4kΩ		3.5		38.6kΩ
1.85		229.0kΩ	11.4kΩ		3.6		17.4kΩ
1.9		102.0kΩ	6.9kΩ		3.7		6.9kΩ
1.95		59.8kΩ	3.3kΩ		3.8		0.5kΩ
2.0		38.6kΩ	0.5kΩ		4.0	(2.4)kΩ	
2.05		25.9kΩ			4.1	(6.5)kΩ	
2.1		17.4kΩ			4.2	(11.7)kΩ	
2.15	(0.0)kΩ	11.4kΩ			4.3	(18.4)kΩ	
2.2	(6.1)kΩ	6.9kΩ			4.4	(27.3)kΩ	
2.25	(14.3)kΩ	3.3kΩ			4.5	(39.7)kΩ	
2.3	(26.6)kΩ	0.5kΩ			4.6	(58.3)kΩ	
2.35	(47.1)kΩ				4.7	(89.4)kΩ	
2.4	(88.1)kΩ				4.8	(152.0)kΩ	
2.45	(206.0)kΩ				4.9	(338.0)kΩ	
2.5					5.0		
2.55	229.0kΩ				5.1	102kΩ	
2.6	102.0kΩ				5.2	38.6kΩ	
2.65	59.8kΩ				5.3	17.4kΩ	
2.7	38.6kΩ				5.4	6.9kΩ	
2.75	25.9kΩ				5.5	0.5kΩ	
2.8	17.4kΩ						
2.85	11.4kΩ						
2.9	6.9kΩ						
2.95	3.4kΩ						
3.0	0.5kΩ						

R1 = (Blue) R2 = Black

PACKAGING INFORMATION

Orderable Device	Status ⁽¹⁾	Package Type	Package Drawing	Pins	Package Qty	Eco Plan ⁽²⁾	Lead/ Ball Finish	MSL Peak Temp ⁽³⁾	Samples (Requires Login)
PT6341A	NRND	SIP MODULE	EPJ	12	21	Pb-Free (RoHS)	Call TI	N / A for Pkg Type	Samples Not Available
PT6341N	NRND	SIP MODULE	EPH	12	21	Pb-Free (RoHS)	Call TI	N / A for Pkg Type	Samples Not Available
PT6342A	NRND	SIP MODULE	EPJ	12	21	Pb-Free (RoHS)	Call TI	N / A for Pkg Type	Samples Not Available
PT6342C	NRND	SIP MODULE	EPK	12	21	Pb-Free (RoHS)	Call TI	Level-1-215C-UNLIM	Samples Not Available
PT6342N	NRND	SIP MODULE	EPH	12	21	Pb-Free (RoHS)	Call TI	N / A for Pkg Type	Samples Not Available
PT6343A	NRND	SIP MODULE	EPJ	12	21	Pb-Free (RoHS)	Call TI	N / A for Pkg Type	Samples Not Available
PT6343C	NRND	SIP MODULE	EPK	12	21	Pb-Free (RoHS)	Call TI	Level-1-215C-UNLIM	Samples Not Available
PT6343N	NRND	SIP MODULE	EPH	12	21	Pb-Free (RoHS)	Call TI	N / A for Pkg Type	Samples Not Available
PT6344C	NRND	SIP MODULE	EPK	12	21	Pb-Free (RoHS)	Call TI	Level-1-215C-UNLIM	Samples Not Available
PT6344N	NRND	SIP MODULE	EPH	12	21	Pb-Free (RoHS)	Call TI	N / A for Pkg Type	Samples Not Available
PT6345A	NRND	SIP MODULE	EPJ	12		TBD	Call TI	Call TI	Samples Not Available
PT6345C	NRND	SIP MODULE	EPK	12	21	Pb-Free (RoHS)	Call TI	Level-1-215C-UNLIM	Samples Not Available
PT6345N	NRND	SIP MODULE	EPH	12	21	Pb-Free (RoHS)	Call TI	N / A for Pkg Type	Samples Not Available
PT6346A	NRND	SIP MODULE	EPJ	12	21	TBD	Call TI	Level-1-215C-UNLIM	Samples Not Available

⁽¹⁾ The marketing status values are defined as follows:

ACTIVE: Product device recommended for new designs.

LIFEBUY: TI has announced that the device will be discontinued, and a lifetime-buy period is in effect.

NRND: Not recommended for new designs. Device is in production to support existing customers, but TI does not recommend using this part in a new design.

PREVIEW: Device has been announced but is not in production. Samples may or may not be available.

OBSELETE: TI has discontinued the production of the device.

⁽²⁾ Eco Plan - The planned eco-friendly classification: Pb-Free (RoHS), Pb-Free (RoHS Exempt), or Green (RoHS & no Sb/Br) - please check <http://www.ti.com/productcontent> for the latest availability information and additional product content details.

TBD: The Pb-Free/Green conversion plan has not been defined.

Pb-Free (RoHS): TI's terms "Lead-Free" or "Pb-Free" mean semiconductor products that are compatible with the current RoHS requirements for all 6 substances, including the requirement that lead not exceed 0.1% by weight in homogeneous materials. Where designed to be soldered at high temperatures, TI Pb-Free products are suitable for use in specified lead-free processes.

Pb-Free (RoHS Exempt): This component has a RoHS exemption for either 1) lead-based flip-chip solder bumps used between the die and package, or 2) lead-based die adhesive used between the die and leadframe. The component is otherwise considered Pb-Free (RoHS compatible) as defined above.

Green (RoHS & no Sb/Br): TI defines "Green" to mean Pb-Free (RoHS compatible), and free of Bromine (Br) and Antimony (Sb) based flame retardants (Br or Sb do not exceed 0.1% by weight in homogeneous material)

⁽³⁾ MSL, Peak Temp. -- The Moisture Sensitivity Level rating according to the JEDEC industry standard classifications, and peak solder temperature.

Important Information and Disclaimer: The information provided on this page represents TI's knowledge and belief as of the date that it is provided. TI bases its knowledge and belief on information provided by third parties, and makes no representation or warranty as to the accuracy of such information. Efforts are underway to better integrate information from third parties. TI has taken and continues to take reasonable steps to provide representative and accurate information but may not have conducted destructive testing or chemical analysis on incoming materials and chemicals. TI and TI suppliers consider certain information to be proprietary, and thus CAS numbers and other limited information may not be available for release.

In no event shall TI's liability arising out of such information exceed the total purchase price of the TI part(s) at issue in this document sold by TI to Customer on an annual basis.

IMPORTANT NOTICE

Texas Instruments Incorporated and its subsidiaries (TI) reserve the right to make corrections, modifications, enhancements, improvements, and other changes to its products and services at any time and to discontinue any product or service without notice. Customers should obtain the latest relevant information before placing orders and should verify that such information is current and complete. All products are sold subject to TI's terms and conditions of sale supplied at the time of order acknowledgment.

TI warrants performance of its hardware products to the specifications applicable at the time of sale in accordance with TI's standard warranty. Testing and other quality control techniques are used to the extent TI deems necessary to support this warranty. Except where mandated by government requirements, testing of all parameters of each product is not necessarily performed.

TI assumes no liability for applications assistance or customer product design. Customers are responsible for their products and applications using TI components. To minimize the risks associated with customer products and applications, customers should provide adequate design and operating safeguards.

TI does not warrant or represent that any license, either express or implied, is granted under any TI patent right, copyright, mask work right, or other TI intellectual property right relating to any combination, machine, or process in which TI products or services are used. Information published by TI regarding third-party products or services does not constitute a license from TI to use such products or services or a warranty or endorsement thereof. Use of such information may require a license from a third party under the patents or other intellectual property of the third party, or a license from TI under the patents or other intellectual property of TI.

Reproduction of TI information in TI data books or data sheets is permissible only if reproduction is without alteration and is accompanied by all associated warranties, conditions, limitations, and notices. Reproduction of this information with alteration is an unfair and deceptive business practice. TI is not responsible or liable for such altered documentation. Information of third parties may be subject to additional restrictions.

Resale of TI products or services with statements different from or beyond the parameters stated by TI for that product or service voids all express and any implied warranties for the associated TI product or service and is an unfair and deceptive business practice. TI is not responsible or liable for any such statements.

TI products are not authorized for use in safety-critical applications (such as life support) where a failure of the TI product would reasonably be expected to cause severe personal injury or death, unless officers of the parties have executed an agreement specifically governing such use. Buyers represent that they have all necessary expertise in the safety and regulatory ramifications of their applications, and acknowledge and agree that they are solely responsible for all legal, regulatory and safety-related requirements concerning their products and any use of TI products in such safety-critical applications, notwithstanding any applications-related information or support that may be provided by TI. Further, Buyers must fully indemnify TI and its representatives against any damages arising out of the use of TI products in such safety-critical applications.

TI products are neither designed nor intended for use in military/aerospace applications or environments unless the TI products are specifically designated by TI as military-grade or "enhanced plastic." Only products designated by TI as military-grade meet military specifications. Buyers acknowledge and agree that any such use of TI products which TI has not designated as military-grade is solely at the Buyer's risk, and that they are solely responsible for compliance with all legal and regulatory requirements in connection with such use.

TI products are neither designed nor intended for use in automotive applications or environments unless the specific TI products are designated by TI as compliant with ISO/TS 16949 requirements. Buyers acknowledge and agree that, if they use any non-designated products in automotive applications, TI will not be responsible for any failure to meet such requirements.

Following are URLs where you can obtain information on other Texas Instruments products and application solutions:

Products		Applications	
Amplifiers	amplifier.ti.com	Audio	www.ti.com/audio
Data Converters	dataconverter.ti.com	Automotive	www.ti.com/automotive
DLP® Products	www.dlp.com	Communications and Telecom	www.ti.com/communications
DSP	dsp.ti.com	Computers and Peripherals	www.ti.com/computers
Clocks and Timers	www.ti.com/clocks	Consumer Electronics	www.ti.com/consumer-apps
Interface	interface.ti.com	Energy	www.ti.com/energy
Logic	logic.ti.com	Industrial	www.ti.com/industrial
Power Mgmt	power.ti.com	Medical	www.ti.com/medical
Microcontrollers	microcontroller.ti.com	Security	www.ti.com/security
RFID	www.ti-rfid.com	Space, Avionics & Defense	www.ti.com/space-avionics-defense
RF/IF and ZigBee® Solutions	www.ti.com/lprf	Video and Imaging	www.ti.com/video
		Wireless	www.ti.com/wireless-apps

Mailing Address: Texas Instruments, Post Office Box 655303, Dallas, Texas 75265
Copyright © 2010, Texas Instruments Incorporated