

MECHANICAL DATA

**GOLD METALLISED  
MULTI-PURPOSE SILICON  
DMOS RF FET  
5W – 12.5V – 1GHz  
PUSH-PULL**

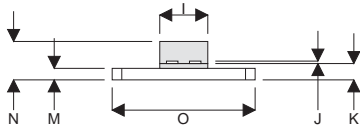
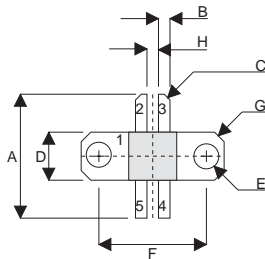

DQ

PIN 1 SOURCE (COMMON) PIN 2 DRAIN 1  
 PIN 3 DRAIN 2 PIN 4 GATE 2  
 PIN 5 GATE 1

DIM	mm	Tol.	Inches	Tol.
A	16.38	0.26	0.645	0.010
B	1.52	0.13	0.060	0.005
C	45°	5°	45°	5°
D	6.35	0.13	0.250	0.005
E	3.30	0.13	0.130	0.005
F	14.22	0.13	0.560	0.005
G	1.27 x 45°	0.13	0.05 x 45°	0.005
H	1.52	0.13	0.060	0.005
I	6.35	0.13	0.250	0.005
J	0.13	0.02	0.005	0.001
K	2.16	0.13	0.085	0.005
M	1.52	0.13	0.060	0.005
N	5.08	MAX	0.200	MAX
O	18.90	0.13	0.744	0.005

FEATURES

- SIMPLIFIED AMPLIFIER DESIGN
- SUITABLE FOR BROAD BAND APPLICATIONS
- VERY LOW  $C_{rss}$
- SIMPLE BIAS CIRCUITS
- LOW NOISE
- HIGH GAIN – 10 dB MINIMUM

APPLICATIONS

- VHF/UHF COMMUNICATIONS  
from 1MHz to 1 GHz

**ABSOLUTE MAXIMUM RATINGS** ( $T_{case} = 25^{\circ}C$  unless otherwise stated)

$P_D$	Power Dissipation	35W
$BV_{DSS}$	Drain – Source Breakdown Voltage *	40V
$BV_{GSS}$	Gate – Source Breakdown Voltage *	$\pm 20V$
$I_{D(sat)}$	Drain Current *	2A
$T_{stg}$	Storage Temperature	-65 to 150°C
$T_j$	Maximum Operating Junction Temperature	200°C

\* Per Side

Semelab Plc reserves the right to change test conditions, parameter limits and package dimensions without notice. Information furnished by Semelab is believed to be both accurate and reliable at the time of going to press. However Semelab assumes no responsibility for any errors or omissions discovered in its use. Semelab encourages customers to verify that datasheets are current before placing orders.

Semelab plc. Telephone +44(0)1455 556565. Fax +44(0)1455 552612.

Document Number 2626

E-mail: [sales@semelab.co.uk](mailto:sales@semelab.co.uk)

Website: <http://www.semelab.co.uk>

Issue 4

## ELECTRICAL CHARACTERISTICS (T<sub>case</sub> = 25°C unless otherwise stated)

Parameter	Test Conditions	Min.	Typ.	Max.	Unit
<b>PER SIDE</b>					
B <sub>V</sub> DSS	Drain–Source Breakdown Voltage	V <sub>GS</sub> = 0      I <sub>D</sub> = 10mA	40		V
I <sub>DSS</sub>	Zero Gate Voltage Drain Current	V <sub>DS</sub> = 12.5V      V <sub>GS</sub> = 0		1	mA
I <sub>GSS</sub>	Gate Leakage Current	V <sub>GS</sub> = 20V      V <sub>DS</sub> = 0		1	µA
V <sub>GS(th)</sub>	Gate Threshold Voltage*	I <sub>D</sub> = 10mA      V <sub>DS</sub> = V <sub>GS</sub>	1	7	V
g <sub>fs</sub>	Forward Transconductance*	V <sub>DS</sub> = 10V      I <sub>D</sub> = 0.2A	0.18		S
<b>TOTAL DEVICE</b>					
G <sub>PS</sub>	Common Source Power Gain	P <sub>O</sub> = 5W	10		dB
η	Drain Efficiency	V <sub>DS</sub> = 12.5V      I <sub>DQ</sub> = 0.2A	40		%
V <sub>SWR</sub>	Load Mismatch Tolerance	f = 1GHz	20:1		—
<b>PER SIDE</b>					
C <sub>iss</sub>	Input Capacitance	V <sub>DS</sub> = 12.5V      V <sub>GS</sub> = -5V      f = 1MHz		12	pF
C <sub>oss</sub>	Output Capacitance	V <sub>DS</sub> = 12.5V      V <sub>GS</sub> = 0      f = 1MHz		10	pF
C <sub>rss</sub>	Reverse Transfer Capacitance	V <sub>DS</sub> = 12.5V      V <sub>GS</sub> = 0      f = 1MHz		1	pF

\* Pulse Test: Pulse Duration = 300 µs , Duty Cycle ≤ 2%

## HAZARDOUS MATERIAL WARNING

The ceramic portion of the device between leads and metal flange is beryllium oxide. Beryllium oxide dust is highly toxic and care must be taken during handling and mounting to avoid damage to this area.

**THESE DEVICES MUST NEVER BE THROWN AWAY WITH GENERAL INDUSTRIAL OR DOMESTIC WASTE.**

## THERMAL DATA

R <sub>THj-case</sub>	Thermal Resistance Junction – Case	Max. 5.0°C / W
-----------------------	------------------------------------	----------------

Semelab Plc reserves the right to change test conditions, parameter limits and package dimensions without notice. Information furnished by Semelab is believed to be both accurate and reliable at the time of going to press. However Semelab assumes no responsibility for any errors or omissions discovered in its use. Semelab encourages customers to verify that datasheets are current before placing orders.

**Semelab plc.** Telephone +44(0)1455 556565. Fax +44(0)1455 552612.

E-mail: [sales@semelab.co.uk](mailto:sales@semelab.co.uk) Website: <http://www.semelab.co.uk>

Document Number 2626

Issue 4

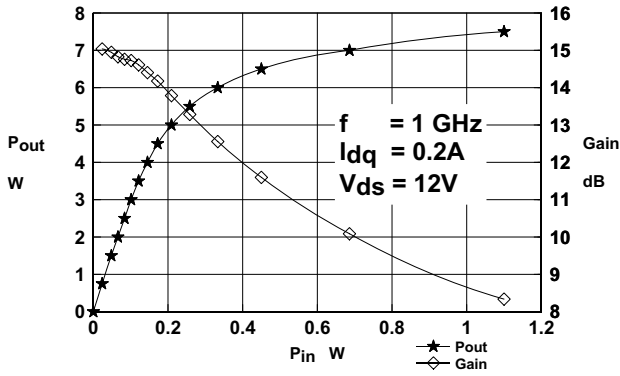

Figure 1 Output Power and Gain vs. Input power

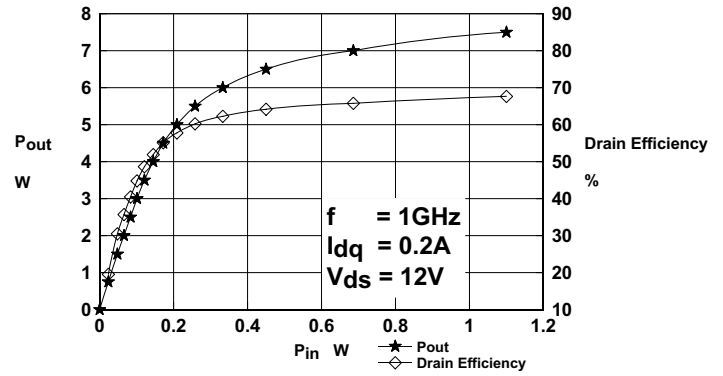

Figure 2 Output Power and Efficiency vs. Input Power

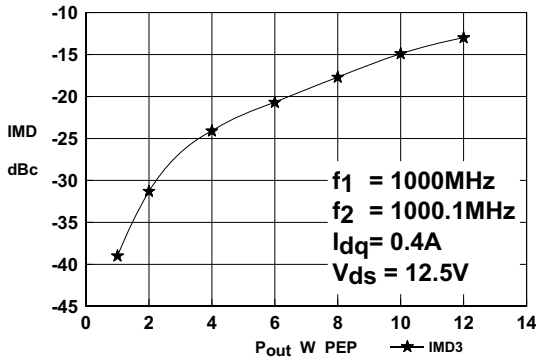

Figure 3 IMD Vs. Output Power.

OPTIMUM SOURCE AND LOAD IMPEDANCE

Frequency MHz	Z <sub>S</sub> Ω	Z <sub>L</sub> Ω
1000MHZ	6.0 + j8.3	7.0 + j9.3

Typical S Parameters

! V<sub>ds</sub>=12.5V, I<sub>dq</sub>=0.2A  
# MHZ S MA R 50

IFreq MHz	S11 mag	ang	S21 mag	ang	S12 mag	ang	S22 mag	ang
100	0.88	-59	13.48	137	0.039	48	0.82	-51
150	0.79	-77	11.02	119	0.047	34	0.75	-65
200	0.74	-88	8.78	105	0.049	24	0.71	-76
250	0.71	-98	7.33	97	0.049	17	0.69	-84
300	0.7	-105	6.36	91	0.048	16	0.68	-91
350	0.69	-111	5.56	81	0.047	9	0.67	-97
400	0.69	-118	4.87	78	0.044	10	0.67	-103
450	0.7	-125	4.3	71	0.04	7	0.67	-110
500	0.71	-131	3.94	68	0.038	10	0.68	-116
550	0.72	-138	3.62	62	0.034	11	0.69	-124
600	0.73	-145	3.43	58	0.033	16	0.7	-130
650	0.75	-151	3.05	51	0.029	21	0.72	-137
700	0.75	-156	2.91	47	0.028	28	0.72	-142
750	0.76	-160	2.59	41	0.027	40	0.72	-147
800	0.76	-162	2.26	36	0.028	49	0.72	-150
850	0.76	-164	2.03	36	0.03	63	0.72	-153
900	0.77	-166	1.93	35	0.034	71	0.72	-156
950	0.77	-168	1.88	34	0.042	79	0.72	-159
1000	0.78	-170	1.81	30	0.05	81	0.72	-162

Semelab Plc reserves the right to change test conditions, parameter limits and package dimensions without notice. Information furnished by Semelab is believed to be both accurate and reliable at the time of going to press. However Semelab assumes no responsibility for any errors or omissions discovered in its use. Semelab encourages customers to verify that datasheets are current before placing orders.

Semelab plc. Telephone +44(0)1455 556565. Fax +44(0)1455 552612.

Document Number 2626

E-mail: [sales@semelab.co.uk](mailto:sales@semelab.co.uk)

Website: <http://www.semelab.co.uk>

Issue 4

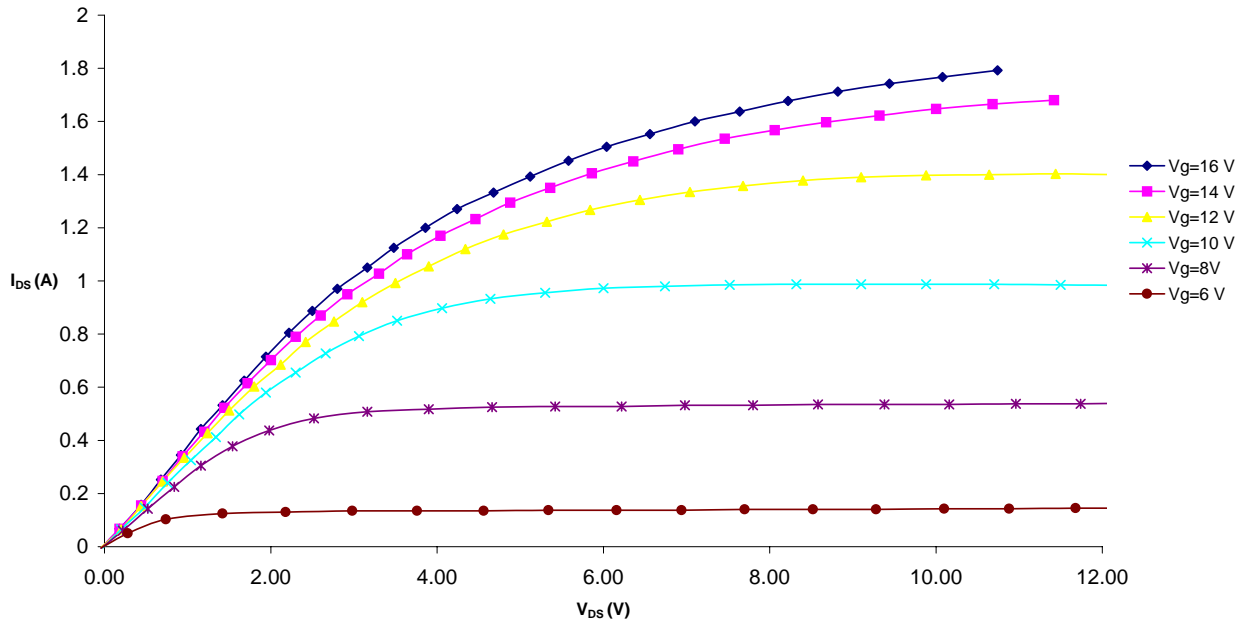

Figure 4 – Typical IV Characteristics.

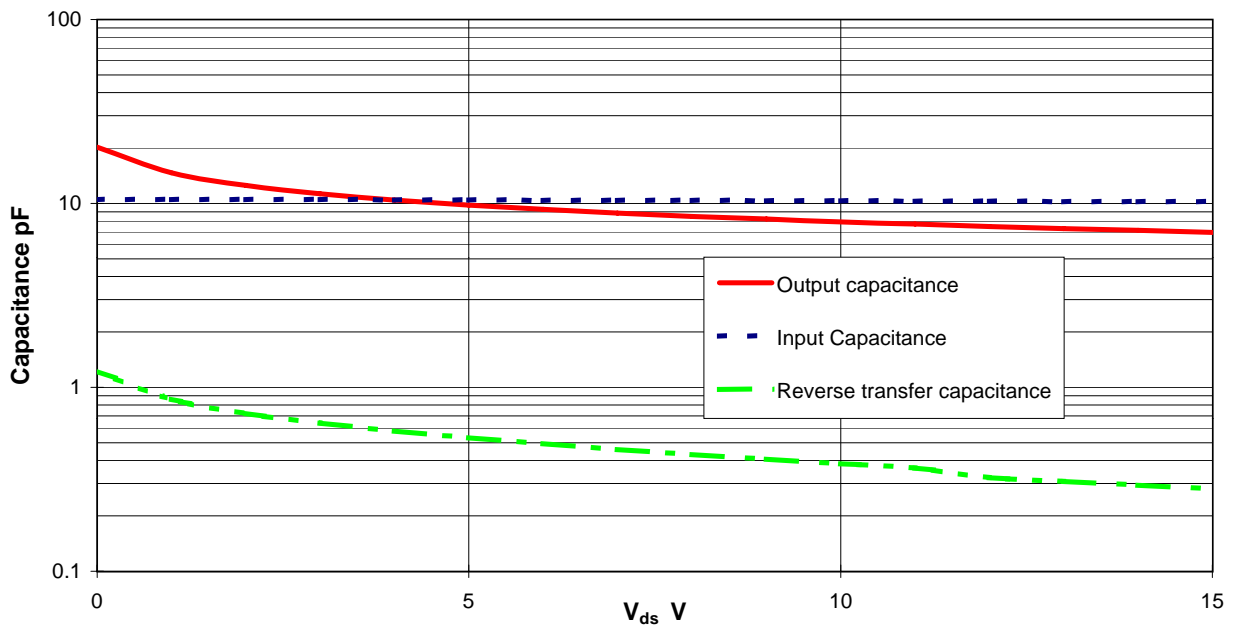
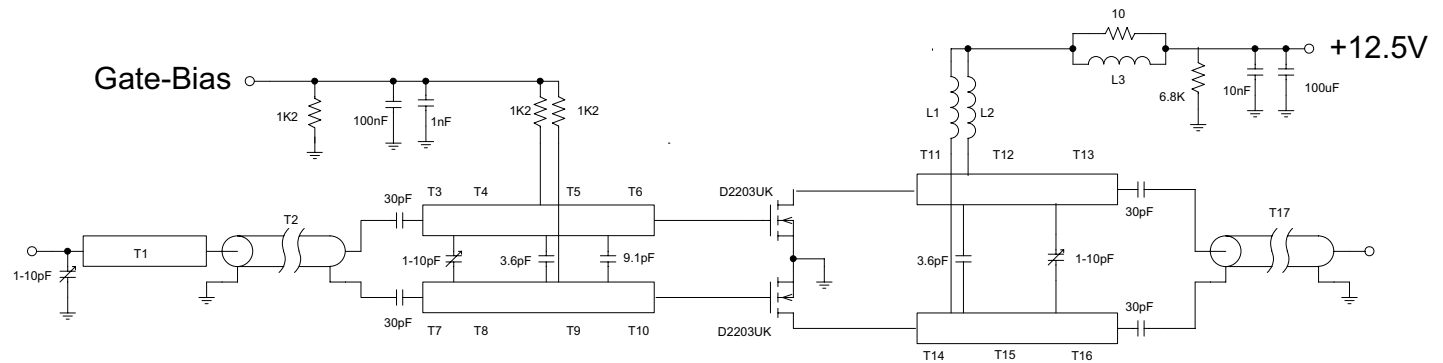

Figure 5 – Typical CV Characteristics.

Semelab Plc reserves the right to change test conditions, parameter limits and package dimensions without notice. Information furnished by Semelab is believed to be both accurate and reliable at the time of going to press. However Semelab assumes no responsibility for any errors or omissions discovered in its use. Semelab encourages customers to verify that datasheets are current before placing orders.



## D2203UK 1000MHz TEST FIXTURE

Substrate 0.8mm thick PTFE/glass

All microstrip lines  $W=2.7\text{mm}$

- T1 15.7mm
- T2, T17 45mm 50 Ohm UT34 semi-rigid coax
- T3, T7 7mm
- T4, T8 15mm
- T5, T9 7.6mm
- T6, T10 8mm
- T11, T14 8mm
- T12, T15 11.2mm
- T13, T16 7mm

L1, L2 6 turns of 24swg enamelled copper wire, 3mm i.d.

L3 1.5 turn 24swg enamelled copper wire on Siemens B62152-A7X 2 hole core

Semelab Plc reserves the right to change test conditions, parameter limits and package dimensions without notice. Information furnished by Semelab is believed to be both accurate and reliable at the time of going to press. However Semelab assumes no responsibility for any errors or omissions discovered in its use. Semelab encourages customers to verify that datasheets are current before placing orders.

**Semelab plc.** Telephone +44(0)1455 556565. Fax +44(0)1455 552612.

E-mail: [sales@semelab.co.uk](mailto:sales@semelab.co.uk) Website: <http://www.semelab.co.uk>

Document Number 2626

Issue 4