

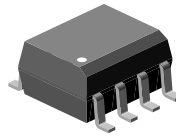

## Optocoupler, Photodarlington Output, Low Input Current, High Gain, With Base Connection

### Features

- Isolation test voltage, 3000 V<sub>RMS</sub>
- Industry Standard SOIC-8 surface mountable package
- Standard Lead Spacing, .05 "
- Available only on tape and reel (conforms to EIA Standard RS481A)
- Compatible with dual wave, vapor phase and IR reflow soldering
- Lead-free component



1179022

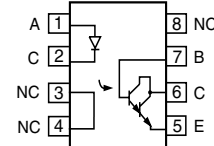

- Component in accordance to RoHS 2002/95/EC and WEEE 2002/96/EC

The device has a CTR tested at 1.0 mA LED current. This low drive current permits easy interfacing from CMOS to LSTTL or TTL.

### Agency Approvals

- UL1577, File No. E52744 System Code Y
- DIN EN 60747-5-2 (VDE0884)  
DIN EN 60747-5-5 pending  
Available with Option 1
- FIMKO

This optocoupler is constructed in a standard SOIC-8 foot print which makes it ideally suited for high density applications. In addition to eliminating through-hole requirements, this package conforms to standards for surface mount devices.

### Description

The IL221AT/ IL222AT/ IL223AT is a high current transfer ratio (CTR) optocoupler with a gallium arsenide infrared LED emitter and a silicon NPN photodarlington transistor detector.

### Order Information

Part	Remarks
IL221AT	CTR > 100 %, SOIC-8
IL222AT	CTR > 200 %, SOIC-8
IL223AT	CTR > 500 %, SOIC-8

For additional information on the available options refer to Option Information.

### Absolute Maximum Ratings

T<sub>amb</sub> = 25 °C, unless otherwise specified

Stresses in excess of the absolute Maximum Ratings can cause permanent damage to the device. Functional operation of the device is not implied at these or any other conditions in excess of those given in the operational sections of this document. Exposure to absolute Maximum Rating for extended periods of the time can adversely affect reliability.

### Input

Parameter	Test condition	Symbol	Value	Unit
Peak reverse voltage		V <sub>R</sub>	6.0	V
Forward continuous current		I <sub>F</sub>	60	mA
Power dissipation		P <sub>diss</sub>	90	mW
Derate linearly from 25°C			1.2	mW/°C

### Output

Parameter	Test condition	Symbol	Value	Unit
Collector-emitter breakdown voltage		$BV_{CEO}$	30	V
Emitter-collector breakdown voltage		$BV_{ECO}$	5.0	V
Collector-base breakdown voltage		$BV_{CBO}$	70	V
$I_{C\text{MAX DC}}$		$I_{C\text{MAX DC}}$	50	mA
$I_{C\text{MAX}}$	$t < 1.0 \text{ ms}$	$I_{C\text{MAX}}$	100	mW
Power dissipation		$P_{\text{diss}}$	150	mW
Derate linearly from 25 °C			2.0	mW/°C

### Coupler

Parameter	Test condition	Symbol	Value	Unit
Total package dissipation (at 25 °C ambient) (LED + detector)		$P_{\text{tot}}$	240	mW
Derate linearly from 25 °C			3.2	mW/°C
Storage temperature		$T_{\text{stg}}$	- 55 to +150	°C
Operating temperature		$T_{\text{amb}}$	- 55 to +100	°C
Soldering time at 260 °C			10	sec.

### Electrical Characteristics

$T_{\text{amb}} = 25 \text{ °C}$ , unless otherwise specified

Minimum and maximum values are testing requirements. Typical values are characteristics of the device and are the result of engineering evaluation. Typical values are for information only and are not part of the testing requirements.

### Input

Parameter	Test condition	Symbol	Min	Typ.	Max	Unit
Forward voltage	$I_F = 1.0 \text{ mA}$	$V_F$		1.0	1.5	V
Reverse current	$V_R = 6.0 \text{ V}$	$I_R$		0.1	100	$\mu\text{A}$
Capacitance	$V_R = 0 \text{ V}$ , $F = 1.0 \text{ MHz}$	$C_O$		25		pF

### Output

Parameter	Test condition	Symbol	Min	Typ.	Max	Unit
Collector-emitter breakdown voltage	$I_C = 100 \mu\text{A}$	$BV_{CEO}$	30			V
Emitter-collector breakdown voltage	$I_E = 100 \mu\text{A}$	$BV_{ECO}$	5.0			V
Collector-emitter breakdown voltage	$I_C = 10 \mu\text{A}$	$BV_{CEO}$	70			V
Collector-emitter capacitance	$V_{CE} = 10 \text{ V}$	$C_{CE}$		3.4		pF

## Coupler

Parameter	Test condition	Symbol	Min	Typ.	Max	Unit
Saturation voltage collector-emitter	$I_{CE} = 0.5 \text{ mA}$	$V_{CEsat}$			1.0	V
Isolation test voltage	$t = 1.0 \text{ sec.}$	$V_{ISO}$	3000			$V_{RMS}$
Capacitance (input-output)		$C_{IO}$		0.5		pF
Resistance input to output		$R_{IO}$		100		$G\Omega$

## Current Transfer Ratio

Parameter	Test condition	Part	Symbol	Min	Typ.	Max	Unit
DC Current Transfer Ratio	$I_F = 1.0 \text{ mA}, V_{CE} = 5.0 \text{ V}$	IL221AT	$CTR_{DC}$	100			%
		IL222AT	$CTR_{DC}$	200			%
		IL223AT	$CTR_{DC}$	500			%

## Typical Characteristics ( $T_{amb} = 25^\circ\text{C}$ unless otherwise specified)

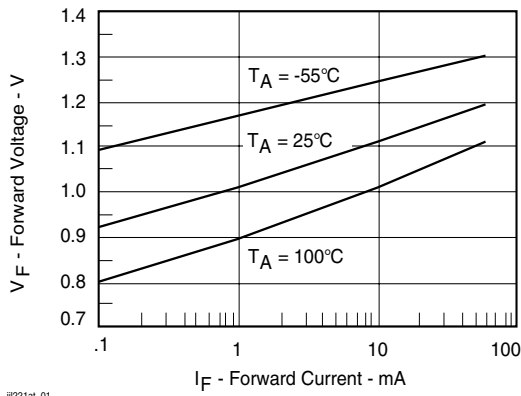

Figure 1. Forward Voltage vs. Forward Current

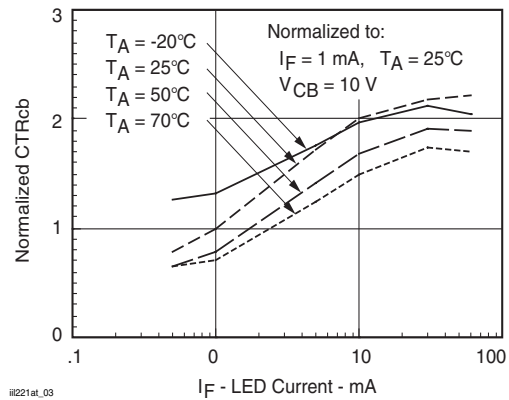

Figure 3. Normalized  $CTR_{CB}$  vs.  $I_F$

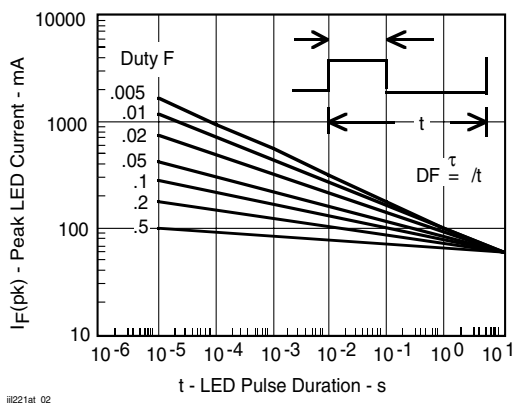

Figure 2. Peak LED Current vs. Duty Factor, Tau

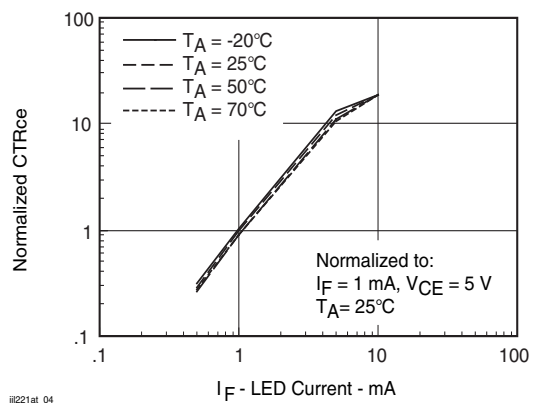

Figure 4. Normalized  $CTR_{CE}$  vs. LED Current

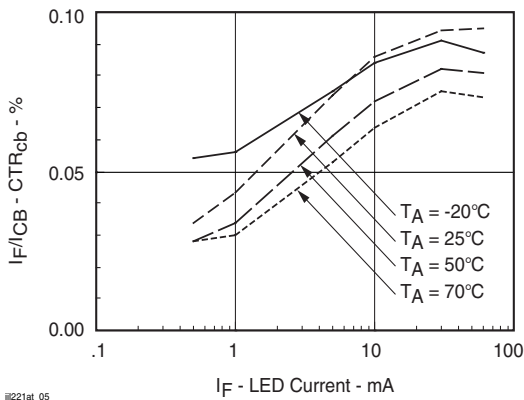

Figure 5.  $CTR_{CB}$  vs. LED Current

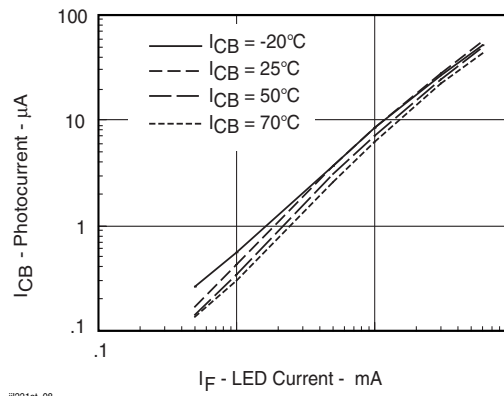

Figure 8. Photocurrent vs. LED Current

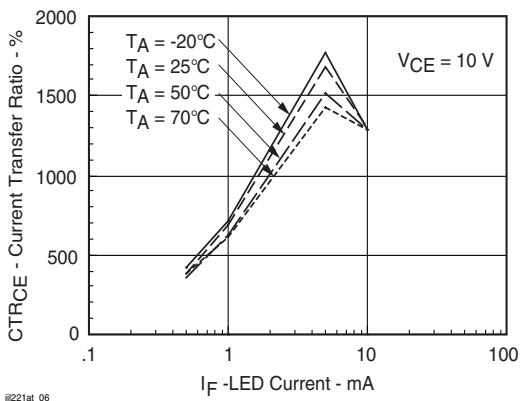

Figure 6. CTR vs. LED Current

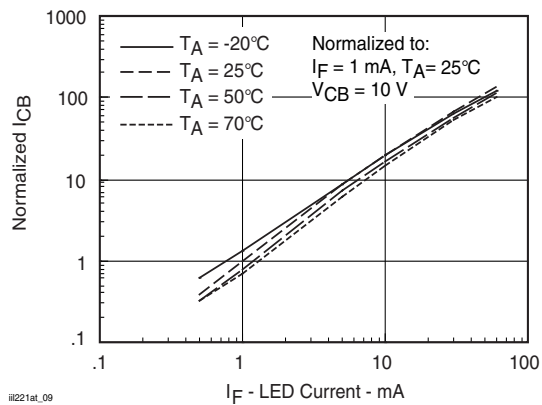

Figure 9. Normalized  $I_{CB}$  vs.  $I_F$

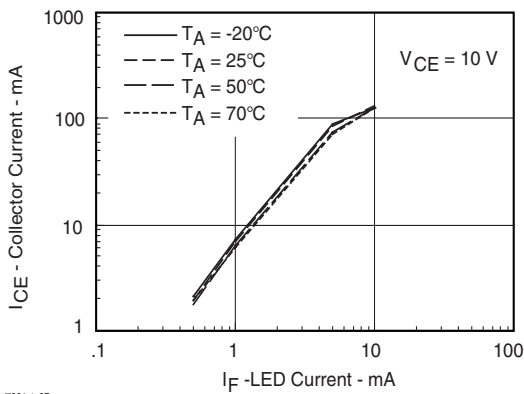

Figure 7. Collector Current vs. LED Current

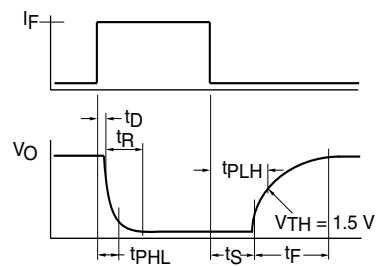
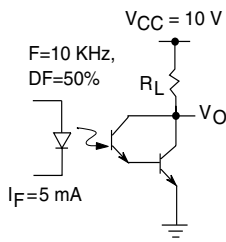

Figure 10. Switching Timing

Figure 11. Switching Schematic



il221at\_11

## Package Dimensions in Inches (mm)

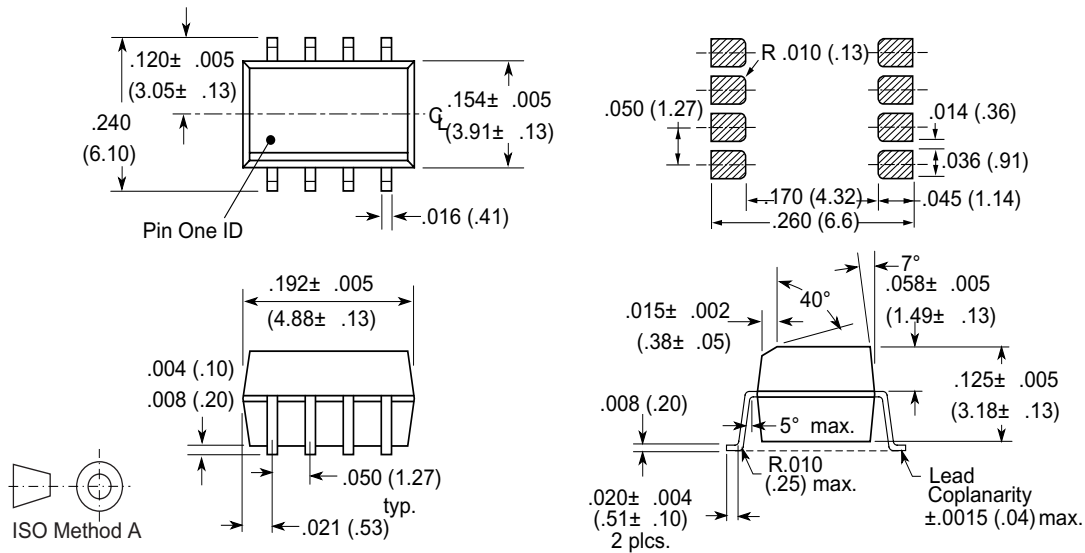

1178003

### Ozone Depleting Substances Policy Statement

It is the policy of Vishay Semiconductor GmbH to

1. Meet all present and future national and international statutory requirements.
2. Regularly and continuously improve the performance of our products, processes, distribution and operating systems with respect to their impact on the health and safety of our employees and the public, as well as their impact on the environment.

It is particular concern to control or eliminate releases of those substances into the atmosphere which are known as ozone depleting substances (ODSs).

The Montreal Protocol (1987) and its London Amendments (1990) intend to severely restrict the use of ODSs and forbid their use within the next ten years. Various national and international initiatives are pressing for an earlier ban on these substances.

Vishay Semiconductor GmbH has been able to use its policy of continuous improvements to eliminate the use of ODSs listed in the following documents.

1. Annex A, B and list of transitional substances of the Montreal Protocol and the London Amendments respectively
2. Class I and II ozone depleting substances in the Clean Air Act Amendments of 1990 by the Environmental Protection Agency (EPA) in the USA
3. Council Decision 88/540/EEC and 91/690/EEC Annex A, B and C (transitional substances) respectively.

Vishay Semiconductor GmbH can certify that our semiconductors are not manufactured with ozone depleting substances and do not contain such substances.

We reserve the right to make changes to improve technical design  
and may do so without further notice.

Parameters can vary in different applications. All operating parameters must be validated for each customer application by the customer. Should the buyer use Vishay Semiconductors products for any unintended or unauthorized application, the buyer shall indemnify Vishay Semiconductors against all claims, costs, damages, and expenses, arising out of, directly or indirectly, any claim of personal damage, injury or death associated with such unintended or unauthorized use.

Vishay Semiconductor GmbH, P.O.B. 3535, D-74025 Heilbronn, Germany  
Telephone: 49 (0)7131 67 2831, Fax number: 49 (0)7131 67 2423