

Optocoupler, Phototransistor Output, AC Input

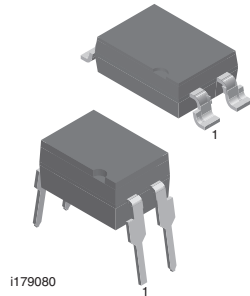

i179080

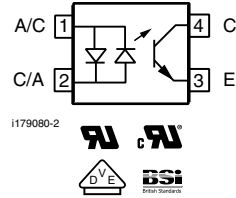

FEATURES

- Good CTR linearity depending on forward current
- Isolation test voltage, 5300 V_{RMS}
- High collector emitter voltage, V_{CEO} = 70 V
- Low saturation voltage
- Fast switching times
- Low CTR degradation
- Temperature stable
- Low coupling capacitance
- End-stackable, 0.100" (2.54 mm) spacing
- High common-mode interference immunity
- Compliant to RoHS Directive to 2002/95/EC and in accordance WEEE 2002/96/EC

RoHS
COMPLIANT

DESCRIPTION

The SFH620A (DIP) and SFH6206 (SMD) feature a high current transfer ratio, low coupling capacitance and high isolation voltage. These couplers have a GaAs infrared diode emitter, which is optically coupled to a silicon planar phototransistor detector, and is incorporated in a plastic DIP-4 or SMD package.

The coupling devices are designed for signal transmission between two electrically separated circuits. The couplers are end-stackable with 2.54 mm lead spacing. Creepage and clearance distances of > 8 mm are achieved with option 6. This version complies with IEC 60950 (DIN VDE 0805) for reinforced insulation to an operation voltage of 400 V_{RMS} or DC.

AGENCY APPROVALS

- UL1577, file no. E52744 system code H, double protection
- CSA 93751
- BSI IEC 60950; IEC 60065
- DIN EN 60747-5-2 (VDE 0884)/DIN EN 60747-5-5 (pending), available with option 1

ORDERING INFORMATION

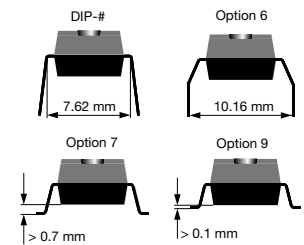
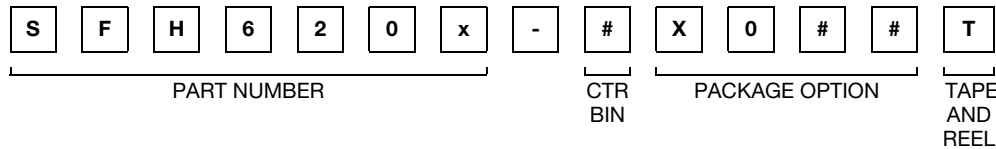

AGENCY CERTIFIED/PACKAGE	CTR (%)					
	± 10 mA					
	SFH620A			SFH6206		
UL, cUL, BSI	40 to 125	63 to 200	100 to 320	40 to 125	63 to 200	100 to 320
DIP-4	SFH620A-1	SFH620A-2	SFH620A-3	-	-	-
DIP-4, 400 mil, option 6	SFH620A-1X006	SFH620A-2X006	SFH620A-3X006	-	-	-
SMD-4, option 7	-	SFH620A-2X007T ⁽¹⁾	-	-	-	-
SMD-4, option 9	-	-	-	SFH6206-1T ⁽¹⁾	SFH6206-2T ⁽¹⁾	SFH6206-3T ⁽¹⁾
VDE, UL, cUL, BSI	40 to 125	63 to 200	100 to 320	40 to 125	63 to 200	100 to 320
DIP-4	SFH620A-1X001	SFH620A-2X001	SFH620A-3X001	-	-	-
DIP-4, 400 mil, option 6	-	SFH620A-2X016	SFH620A-3X016	-	-	-
SMD-4, option 7	-	SFH620A-2X017T	-	-	-	-
SMD-4, option 9	-	-	-	-	SFH6206-2X001T ⁽¹⁾	SFH6206-3X001T ⁽¹⁾

Note

- Additional options may be possible, please contact sales office.
- ⁽¹⁾ Also available in tubes; do not add T to end.

ABSOLUTE MAXIMUM RATINGS ($T_{amb} = 25\text{ }^{\circ}\text{C}$, unless otherwise specified)				
PARAMETER	TEST CONDITION	SYMBOL	VALUE	UNIT
INPUT				
DC forward current		I_F	± 60	mA
Surge forward current	$t_p \leq 10\text{ }\mu\text{s}$	I_{FSM}	± 2.5	A
Power dissipation		P_{diss}	100	mW
OUTPUT				
Collector emitter voltage		V_{CE}	70	V
Emitter collector voltage		V_{EC}	7	V
Collector current		I_C	50	mA
	$t_p \leq 1\text{ }\mu\text{s}$	I_C	100	mA
Power dissipation		P_{diss}	150	mW
COUPLER				
Isolation test voltage between emitter and detector	$t = 1\text{ s}$	V_{ISO}	5300	V_{RMS}
Isolation voltage		V_{IORM}	890	V_P
Total power dissipation		P_{tot}	250	mW
Creepage distance			≥ 7	mm
Clearance distance			≥ 7	mm
Insulation thickness between emitter and detector			≥ 4	mm
Comparative tracking index per DIN IEC112/ VDE 0303, part 1		CTI	175	
Isolation resistance	$V_{IO} = 500\text{ V}, T_{amb} = 25\text{ }^{\circ}\text{C}$	R_{IO}	$\geq 10^{12}$	Ω
	$V_{IO} = 500\text{ V}, T_{amb} = 100\text{ }^{\circ}\text{C}$	R_{IO}	$\geq 10^{11}$	Ω
Storage temperature range		T_{stg}	- 55 to + 150	$^{\circ}\text{C}$
Ambient temperature range		T_{amb}	- 55 to + 100	$^{\circ}\text{C}$
Junction temperature		T_j	100	$^{\circ}\text{C}$
Soldering temperature ⁽¹⁾	max. 10 s, dip soldering distance	T_{sld}	260	$^{\circ}\text{C}$

Notes

- Stresses in excess of the absolute maximum ratings can cause permanent damage to the device. Functional operation of the device is not implied at these or any other conditions in excess of those given in the operational sections of this document. Exposure to absolute maximum ratings for extended periods of the time can adversely affect reliability.
- ⁽¹⁾ Refer to reflow profile for soldering conditions for surface mounted devices (SMD). Refer to wave profile for soldering conditions for through hole devices (DIP).

ELECTRICAL CHARACTERISTICS ($T_{amb} = 25\text{ }^{\circ}\text{C}$, unless otherwise specified)							
PARAMETER	TEST CONDITION	PART	SYMBOL	MIN.	TYP.	MAX.	UNIT
INPUT							
Forward voltage	$I_F = \pm 60\text{ mA}$		V_F		1.25	1.65	V
Capacitance	$V_R = 0\text{ V}, f = 1\text{ MHz}$		C_O		50		pF
Thermal resistance			R_{thja}		750		K/W
OUTPUT							
Collector emitter capacitance	$V_{CE} = 5\text{ V}, f = 1\text{ MHz}$		C_{CE}		6.8		pF
Thermal resistance			R_{thja}		500		$^{\circ}\text{C}/\text{W}$
COUPLER							
Collector emitter saturation voltage	$I_F = \pm 10\text{ mA}, I_C = 2.5\text{ mA}$		V_{CEsat}		0.25	0.4	V
Coupling capacitance			C_C		0.2		pF
Collector emitter leakage current	$V_{CE} = 10\text{ V}$	SFH620A-1	I_{CEO}		2	50	nA
		SFH6206-1	I_{CEO}		2	50	nA
		SFH620A-2	I_{CEO}		2	50	nA
		SFH6206-2	I_{CEO}		2	50	nA
		SFH620A-3	I_{CEO}		5	100	nA
		SFH6206-3	I_{CEO}		5	100	nA

Note

- Minimum and maximum values are testing requirements. Typical values are characteristics of the device and are the result of engineering evaluation. Typical values are for information only and are not part of the testing requirements. Still air, coupler soldered to PCB or base.

CURRENT TRANSFER RATIO ($T_{amb} = 25\text{ }^{\circ}\text{C}$, unless otherwise specified)							
PARAMETER	TEST CONDITION	PART	SYMBOL	MIN.	TYP.	MAX.	UNIT
I_C/I_F	$V_{CE} = 5\text{ V}$, $I_F = \pm 10\text{ mA}$	SFH620A-1	CTR	40		125	%
		SFH6206-1	CTR	40		125	%
		SFH620A-2	CTR	63		200	%
		SFH6206-2	CTR	63		200	%
		SFH620A-3	CTR	100		320	%
		SFH6206-3	CTR	100		320	%
	$V_{CE} = 5\text{ V}$, $I_F = \pm 1\text{ mA}$	SFH620A-1	CTR	13	30		%
		SFH6206-1	CTR	13	30		%
		SFH620A-2	CTR	22	45		%
		SFH6206-2	CTR	22	45		%
		SFH620A-3	CTR	34	70		%
		SFH6206-3	CTR	34	70		%

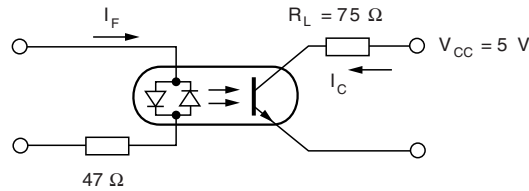

isfh620a_08

Fig. 1 - Switching Times Linear Operation (without Saturation)

SWITCHING CHARACTERISTICS ($T_{amb} = 25\text{ }^{\circ}\text{C}$, unless otherwise specified)						
PARAMETER	TEST CONDITION	SYMBOL	MIN.	TYP.	MAX.	UNIT
Turn-on time	$R_L = 75\text{ }\Omega$, $I_F = \pm 10\text{ mA}$, $V_{CC} = 5\text{ V}$	t_{on}		3		μs
Rise time	$R_L = 75\text{ }\Omega$, $I_F = \pm 10\text{ mA}$, $V_{CC} = 5\text{ V}$	t_r		2		μs
Turn-off time	$R_L = 75\text{ }\Omega$, $I_F = \pm 10\text{ mA}$, $V_{CC} = 5\text{ V}$	t_{off}		2.3		μs
Fall time	$R_L = 75\text{ }\Omega$, $I_F = \pm 10\text{ mA}$, $V_{CC} = 5\text{ V}$	t_f		2		μs
Cut-off frequency	$R_L = 75\text{ }\Omega$, $I_F = \pm 10\text{ mA}$, $V_{CC} = 5\text{ V}$	t_{ctr}		250		kHz

SAFETY AND INSULATION RATINGS						
PARAMETER	TEST CONDITION	SYMBOL	MIN.	TYP.	MAX.	UNIT
Climatic classification (according to IEC 68 part 1)				55/100/21		
Comparative tracking index		CTI	175		399	
V_{IOTM}			10 000			V
V_{IORM}			890			V
P_{SO}					400	mW
I_{SI}					275	mA
T_{SI}					175	$^{\circ}\text{C}$
Creepage distance	Standard DIP-4		7			mm
Clearance distance	Standard DIP-4		7			mm
Creepage distance	400 mil DIP-4		8			mm
Clearance distance	400 mil DIP-4		8			mm
Insulation thickness, reinforced rated	per IEC 60950 2.10.5.1		0.4			mm

Note

- As per IEC 60747-5-5, § 7.4.3.8.1, this optocoupler is suitable for "safe electrical insulation" only within the safety ratings. Compliance with the safety ratings shall be ensured by means of protective circuits.

TYPICAL CHARACTERISTICS ($T_{amb} = 25\text{ }^{\circ}\text{C}$, unless otherwise specified)

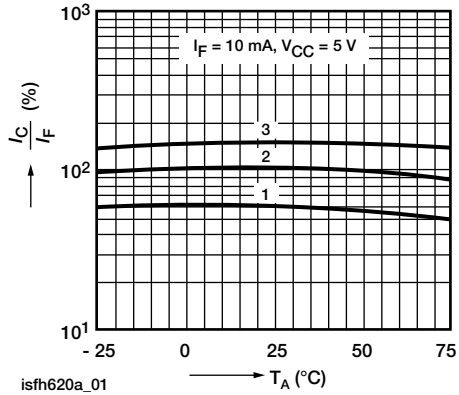

Fig. 2 - Current Transfer Ratio (CTR) vs. Temperature

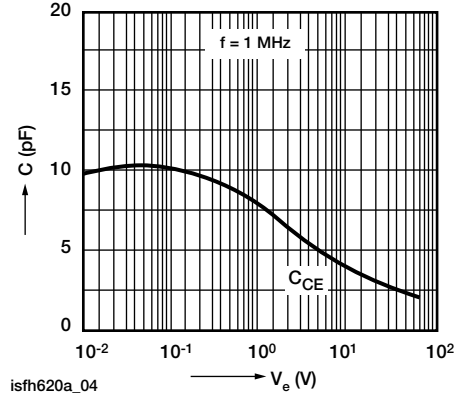

Fig. 5 - Transistor Capacitance (Typ.) vs. Collector Emitter Voltage

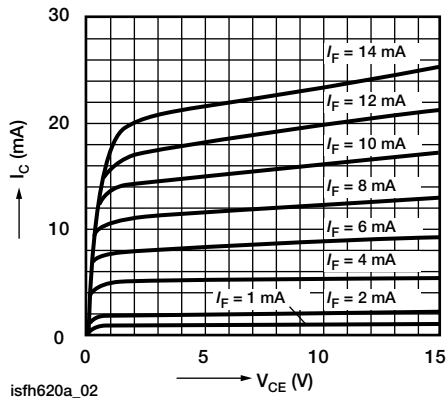

Fig. 3 - Output Characteristics (Typ.) Collector Current vs. Collector Emitter Voltage

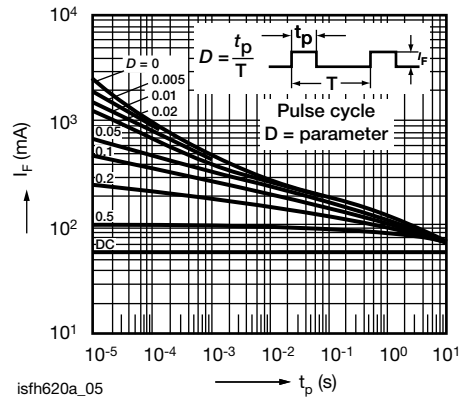

Fig. 6 - Permissible Pulse Handling Capability Forward Current vs. Pulse Width

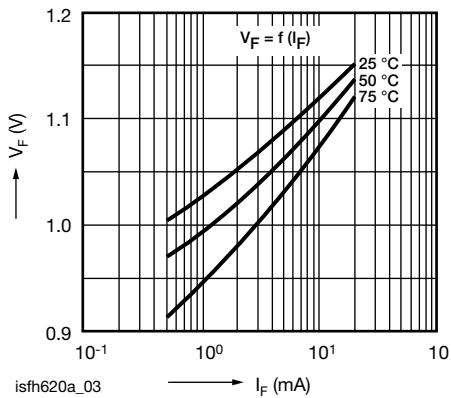

Fig. 4 - Diode Forward Voltage (Typ.) vs. Forward Current

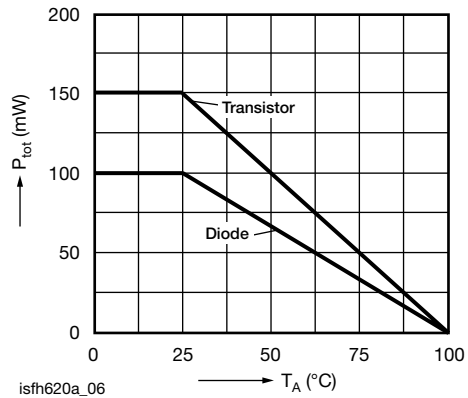

Fig. 7 - Permissible Power Dissipation vs. Ambient Temperature

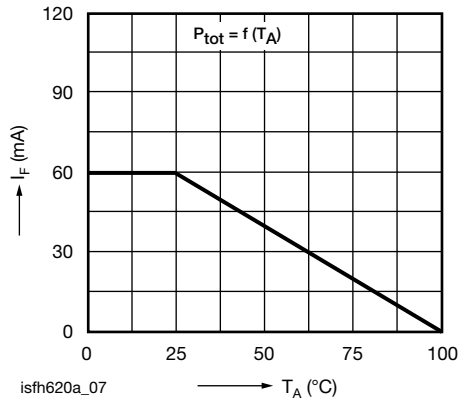
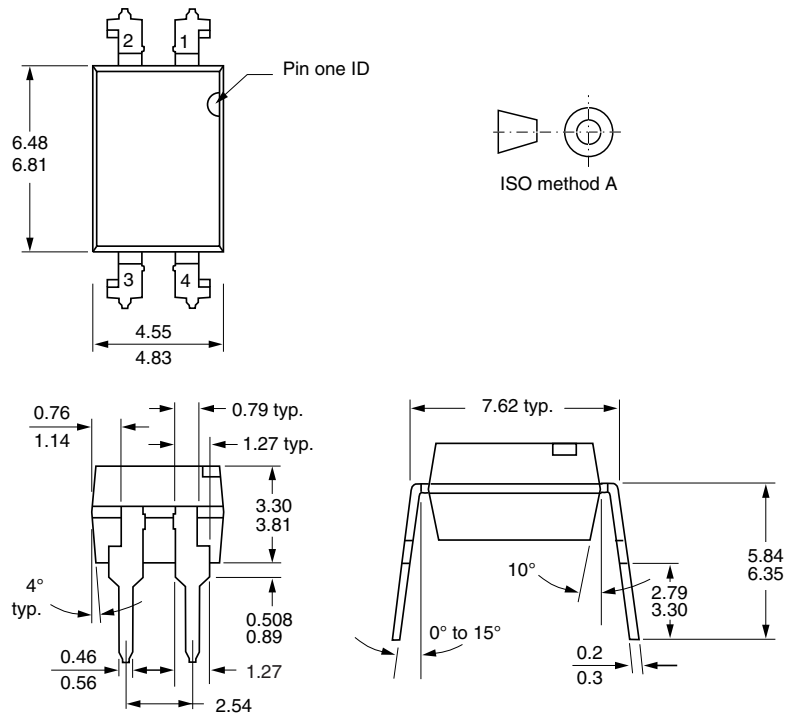

Fig. 8 - Permissible Diode Forward Current vs. Ambient Temperature

PACKAGE DIMENSIONS in millimeters



i178027

SFH620A, SFH6206



Vishay Semiconductors Optocoupler, Phototransistor Output,
AC Input

PACKAGE DIMENSIONS in millimeters

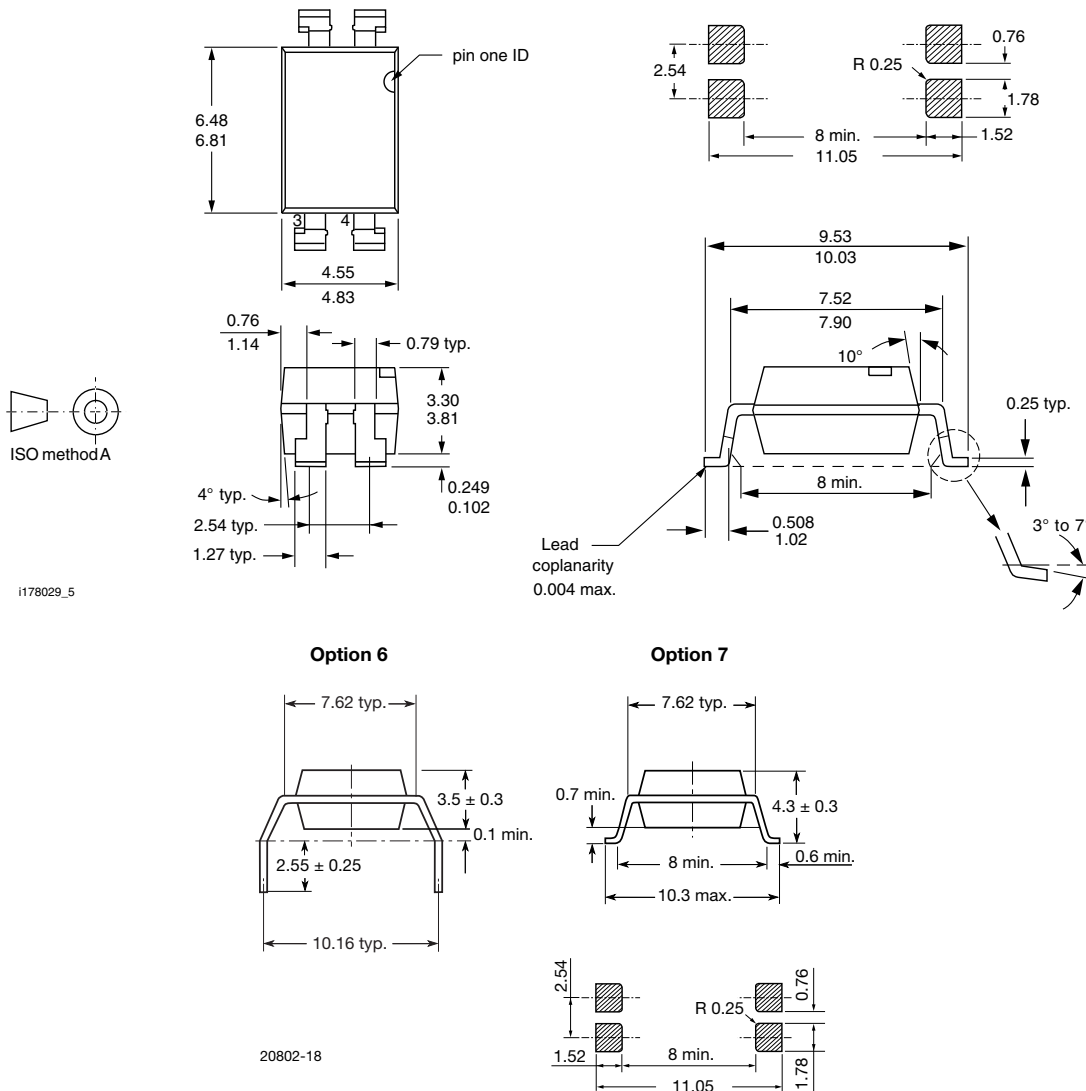

PACKAGE MARKING (example)

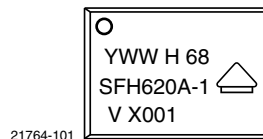

Notes

- Only options 1 and 7 are reflected in the package marking.
- The VDE Logo is only marked on option1 parts.
- Tape and reel suffix (T) is not part of the package marking.



Disclaimer

ALL PRODUCT, PRODUCT SPECIFICATIONS AND DATA ARE SUBJECT TO CHANGE WITHOUT NOTICE TO IMPROVE RELIABILITY, FUNCTION OR DESIGN OR OTHERWISE.

Vishay Intertechnology, Inc., its affiliates, agents, and employees, and all persons acting on its or their behalf (collectively, "Vishay"), disclaim any and all liability for any errors, inaccuracies or incompleteness contained in any datasheet or in any other disclosure relating to any product.

Vishay makes no warranty, representation or guarantee regarding the suitability of the products for any particular purpose or the continuing production of any product. To the maximum extent permitted by applicable law, Vishay disclaims (i) any and all liability arising out of the application or use of any product, (ii) any and all liability, including without limitation special, consequential or incidental damages, and (iii) any and all implied warranties, including warranties of fitness for particular purpose, non-infringement and merchantability.

Statements regarding the suitability of products for certain types of applications are based on Vishay's knowledge of typical requirements that are often placed on Vishay products in generic applications. Such statements are not binding statements about the suitability of products for a particular application. It is the customer's responsibility to validate that a particular product with the properties described in the product specification is suitable for use in a particular application. Parameters provided in datasheets and/or specifications may vary in different applications and performance may vary over time. All operating parameters, including typical parameters, must be validated for each customer application by the customer's technical experts. Product specifications do not expand or otherwise modify Vishay's terms and conditions of purchase, including but not limited to the warranty expressed therein.

Except as expressly indicated in writing, Vishay products are not designed for use in medical, life-saving, or life-sustaining applications or for any other application in which the failure of the Vishay product could result in personal injury or death. Customers using or selling Vishay products not expressly indicated for use in such applications do so at their own risk and agree to fully indemnify and hold Vishay and its distributors harmless from and against any and all claims, liabilities, expenses and damages arising or resulting in connection with such use or sale, including attorneys fees, even if such claim alleges that Vishay or its distributor was negligent regarding the design or manufacture of the part. Please contact authorized Vishay personnel to obtain written terms and conditions regarding products designed for such applications.

No license, express or implied, by estoppel or otherwise, to any intellectual property rights is granted by this document or by any conduct of Vishay. Product names and markings noted herein may be trademarks of their respective owners.

Material Category Policy

Vishay Intertechnology, Inc. hereby certifies that all its products that are identified as RoHS-Compliant fulfill the definitions and restrictions defined under Directive 2011/65/EU of The European Parliament and of the Council of June 8, 2011 on the restriction of the use of certain hazardous substances in electrical and electronic equipment (EEE) - recast, unless otherwise specified as non-compliant.

Please note that some Vishay documentation may still make reference to RoHS Directive 2002/95/EC. We confirm that all the products identified as being compliant to Directive 2002/95/EC conform to Directive 2011/65/EU.