

Low Current LED in \varnothing 3 mm Tinted Diffused Package

Features

- Low power consumption
- High brightness
- CMOS/MOS compatible
- Specified at $I_F = 2$ mA
- Luminous intensity categorized
- Yellow and green color categorized
- Lead-free device

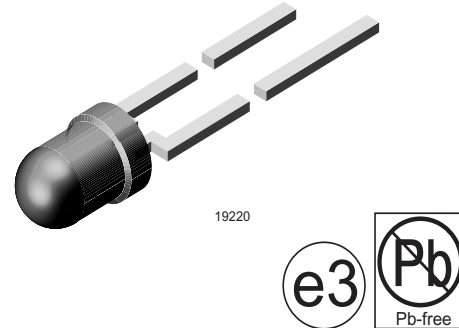

Applications

Low power DC circuits

Parts Table

Part	Color, Luminous Intensity	Angle of Half Intensity ($\pm\phi$)	Technology
TLLR4400	Red, $I_V > 0.63$ mcd	25 °	GaAsP on GaP
TLLR4401	Red, $I_V > 1$ mcd	25 °	GaAsP on GaP
TLLY4400	Yellow, $I_V > 0.63$ mcd	25 °	GaAsP on GaP
TLLY4401	Yellow, $I_V > 1$ mcd	25 °	GaAsP on GaP
TLLG4400	Green, $I_V > 0.63$ mcd	25 °	GaP on GaP
TLLG4401	Green, $I_V > 1$ mcd	25 °	GaP on GaP

Absolute Maximum Ratings

$T_{amb} = 25$ °C, unless otherwise specified

TLL.440.

Parameter	Test condition	Symbol	Value	Unit
Reverse voltage		V_R	6	V
DC Forward current		I_F	7	mA
Surge forward current	$t_p \leq 10$ μ s	I_{FSM}	0.15	A
Power dissipation	$T_{amb} \leq 84$ °C	P_V	20	mW
Junction temperature		T_j	100	°C
Operating temperature range		T_{amb}	- 40 to + 100	°C
Storage temperature range		T_{stg}	- 55 to + 100	°C
Soldering temperature	$t \leq 5$ s, 2 mm from body	T_{sd}	260	°C
Thermal resistance junction/ambient		R_{thJA}	800	K/W

Optical and Electrical Characteristics

$T_{amb} = 25\text{ }^{\circ}\text{C}$, unless otherwise specified

Red

TLLR440.

Parameter	Test condition	Part	Symbol	Min	Typ.	Max	Unit
Luminous intensity ¹⁾	$I_F = 2\text{ mA}$	TLLR4400	I_V	0.63	1.2		mcd
		TLLR4401	I_V	1	2		mcd
Dominant wavelength	$I_F = 2\text{ mA}$		λ_d	612		625	nm
Peak wavelength	$I_F = 2\text{ mA}$		λ_p		635		nm
Angle of half intensity	$I_F = 2\text{ mA}$		ϕ		± 25		deg
Forward voltage	$I_F = 2\text{ mA}$		V_F		1.9	2.4	V
Reverse voltage	$I_R = 10\text{ }\mu\text{A}$		V_R	6	20		V
Junction capacitance	$V_R = 0, f = 1\text{ MHz}$		C_j		50		pF

¹⁾ in one Packing Unit $I_{Vmin}/I_{Vmax} \leq 0.5$

Yellow

TLLY440.

Parameter	Test condition	Part	Symbol	Min	Typ.	Max	Unit
Luminous intensity ¹⁾	$I_F = 2\text{ mA}$	TLLY4400	I_V	0.63	1.2		mcd
		TLLY4401	I_V	1	2		mcd
Dominant wavelength	$I_F = 2\text{ mA}$		λ_d	581		594	nm
Peak wavelength	$I_F = 2\text{ mA}$		λ_p		585		nm
Angle of half intensity	$I_F = 2\text{ mA}$		ϕ		± 25		deg
Forward voltage	$I_F = 2\text{ mA}$		V_F		2.4	2.9	V
Reverse voltage	$I_R = 10\text{ }\mu\text{A}$		V_R	6	20		V
Junction capacitance	$V_R = 0, f = 1\text{ MHz}$		C_j		50		pF

¹⁾ in one Packing Unit $I_{Vmin}/I_{Vmax} \leq 0.5$

Green

TLLG440.

Parameter	Test condition	Part	Symbol	Min	Typ.	Max	Unit
Luminous intensity ¹⁾	$I_F = 2\text{ mA}$	TLLG4400	I_V	0.63	1.2		mcd
		TLLG4401	I_V	1	2		mcd
Dominant wavelength	$I_F = 2\text{ mA}$		λ_d	562		575	nm
Peak wavelength	$I_F = 2\text{ mA}$		λ_p		565		nm
Angle of half intensity	$I_F = 2\text{ mA}$		ϕ		± 25		deg
Forward voltage	$I_F = 2\text{ mA}$		V_F		1.9	2.4	V
Reverse voltage	$I_R = 10\text{ }\mu\text{A}$		V_R	6	20		V
Junction capacitance	$V_R = 0, f = 1\text{ MHz}$		C_j		50		pF

¹⁾ in one Packing Unit $I_{Vmin}/I_{Vmax} \leq 0.5$

Typical Characteristics ($T_{amb} = 25\text{ }^{\circ}\text{C}$ unless otherwise specified)

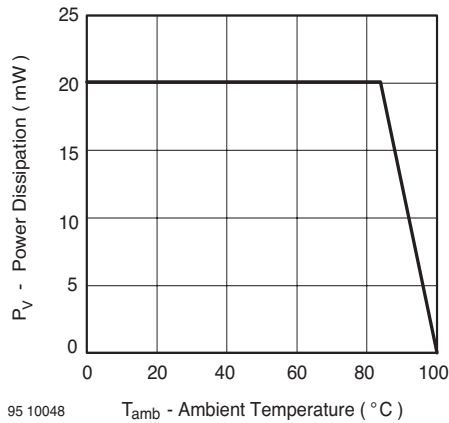

Figure 1. Power Dissipation vs. Ambient Temperature

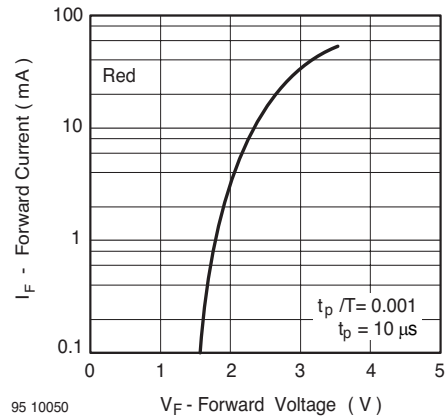

Figure 4. Forward Current vs. Forward Voltage

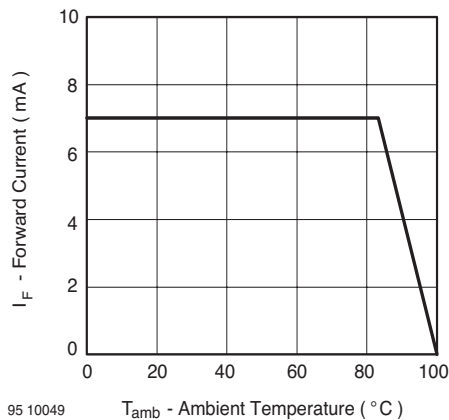

Figure 2. Forward Current vs. Ambient Temperature

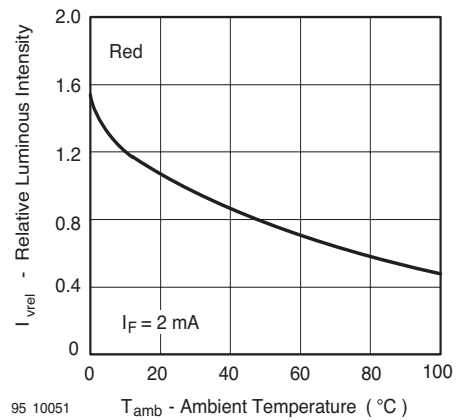

Figure 5. Rel. Luminous Intensity vs. Ambient Temperature

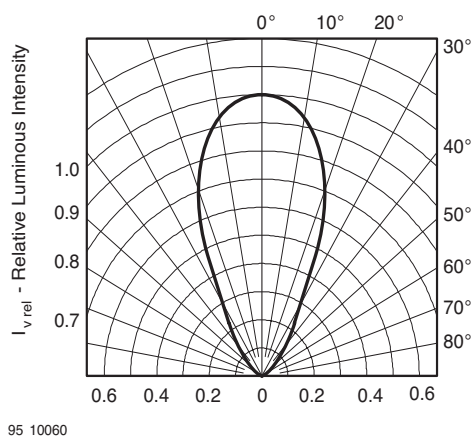

Figure 3. Rel. Luminous Intensity vs. Angular Displacement

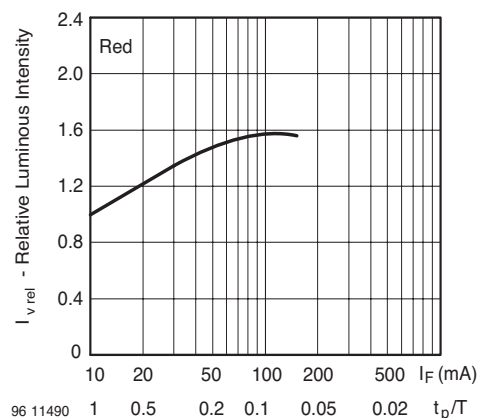

Figure 6. Rel. Lumin. Intensity vs. Forw. Current/Duty Cycle

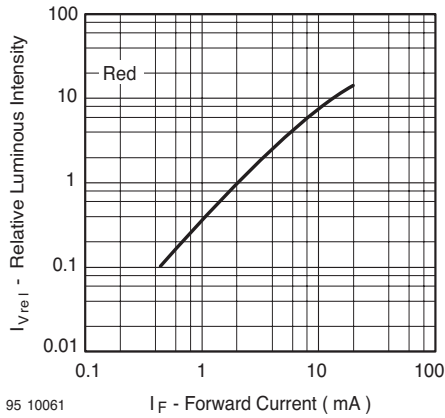

Figure 7. Relative Luminous Intensity vs. Forward Current

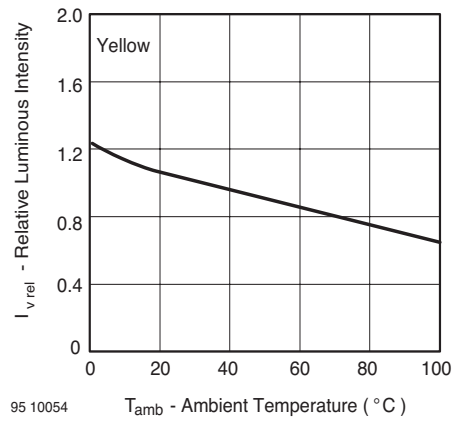

Figure 10. Rel. Luminous Intensity vs. Ambient Temperature

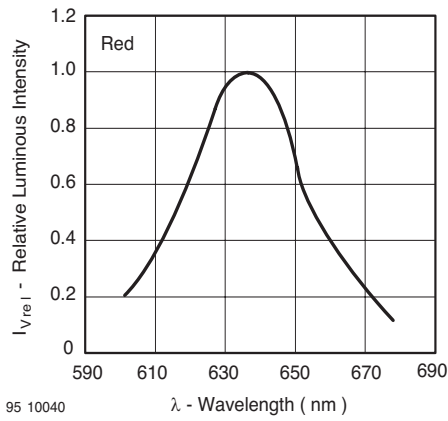

Figure 8. Relative Intensity vs. Wavelength

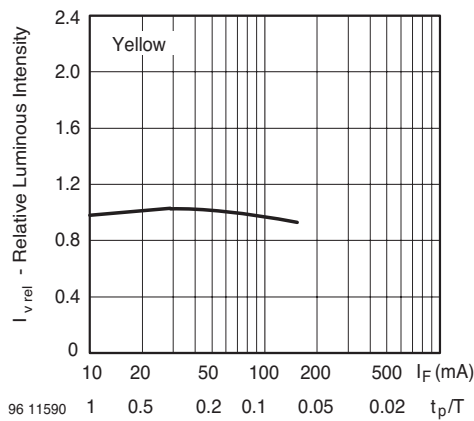

Figure 11. Rel. Lumin. Intensity vs. Forw. Current/Duty Cycle

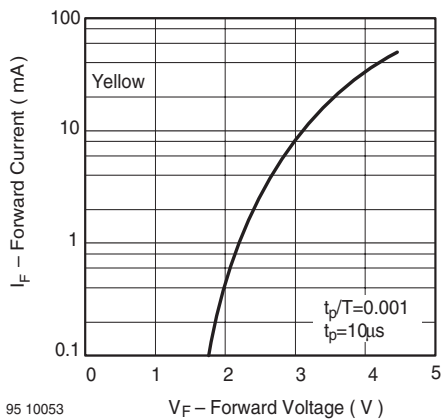

Figure 9. Forward Current vs. Forward Voltage

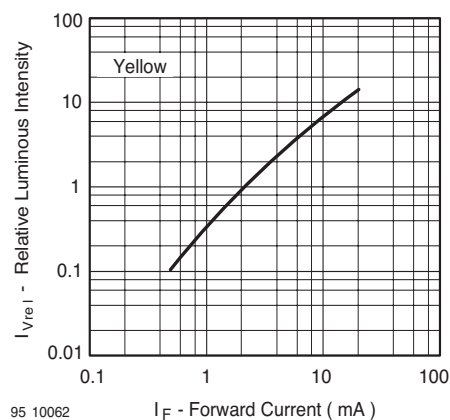

Figure 12. Relative Luminous Intensity vs. Forward Current

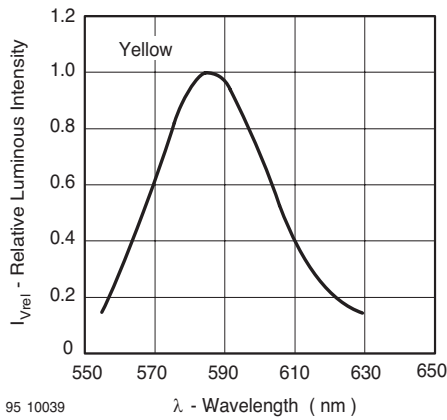

Figure 13. Relative Intensity vs. Wavelength

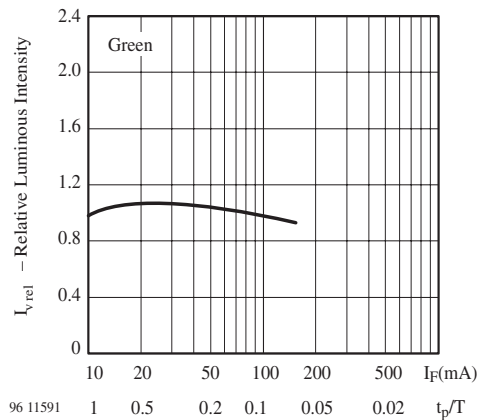

Figure 16. Rel. Lumin. Intensity vs. Forw. Current/Duty Cycle

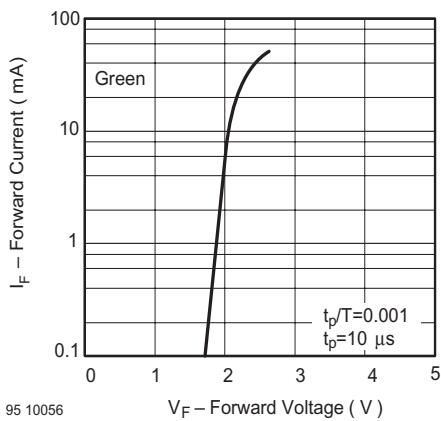

Figure 14. Forward Current vs. Forward Voltage

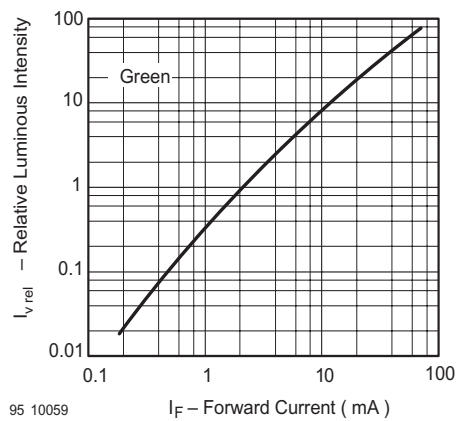

Figure 17. Relative Luminous Intensity vs. Forward Current

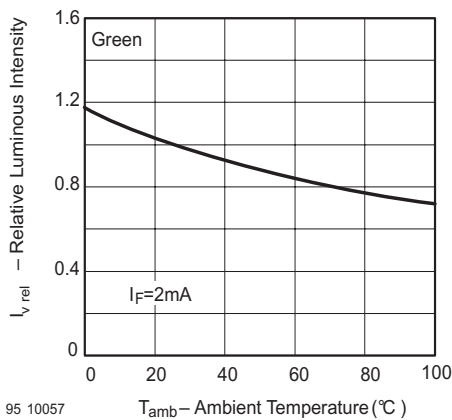

Figure 15. Rel. Luminous Intensity vs. Ambient Temperature

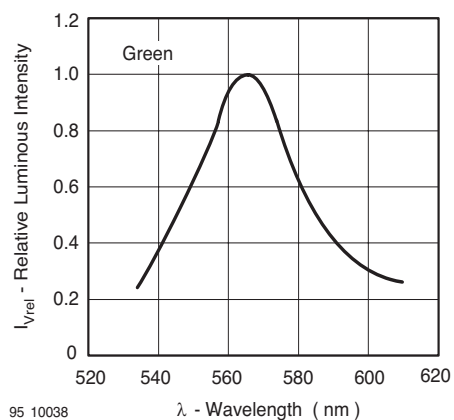
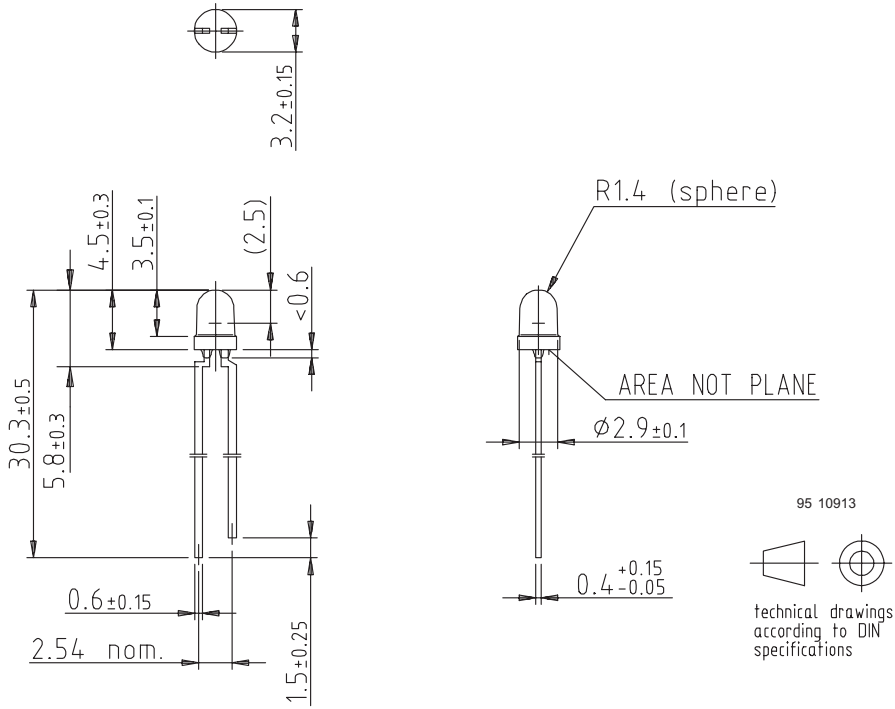

Figure 18. Relative Intensity vs. Wavelength

Package Dimensions in mm





Ozone Depleting Substances Policy Statement

It is the policy of **Vishay Semiconductor GmbH** to

1. Meet all present and future national and international statutory requirements.
2. Regularly and continuously improve the performance of our products, processes, distribution and operating systems with respect to their impact on the health and safety of our employees and the public, as well as their impact on the environment.

It is particular concern to control or eliminate releases of those substances into the atmosphere which are known as ozone depleting substances (ODSs).

The Montreal Protocol (1987) and its London Amendments (1990) intend to severely restrict the use of ODSs and forbid their use within the next ten years. Various national and international initiatives are pressing for an earlier ban on these substances.

Vishay Semiconductor GmbH has been able to use its policy of continuous improvements to eliminate the use of ODSs listed in the following documents.

1. Annex A, B and list of transitional substances of the Montreal Protocol and the London Amendments respectively
2. Class I and II ozone depleting substances in the Clean Air Act Amendments of 1990 by the Environmental Protection Agency (EPA) in the USA
3. Council Decision 88/540/EEC and 91/690/EEC Annex A, B and C (transitional substances) respectively.

Vishay Semiconductor GmbH can certify that our semiconductors are not manufactured with ozone depleting substances and do not contain such substances.

**We reserve the right to make changes to improve technical design
and may do so without further notice.**

Parameters can vary in different applications. All operating parameters must be validated for each customer application by the customer. Should the buyer use Vishay Semiconductors products for any unintended or unauthorized application, the buyer shall indemnify Vishay Semiconductors against all claims, costs, damages, and expenses, arising out of, directly or indirectly, any claim of personal damage, injury or death associated with such unintended or unauthorized use.

Vishay Semiconductor GmbH, P.O.B. 3535, D-74025 Heilbronn, Germany
Telephone: 49 (0)7131 67 2831, Fax number: 49 (0)7131 67 2423