

## Schottky Rectifier, 1 A

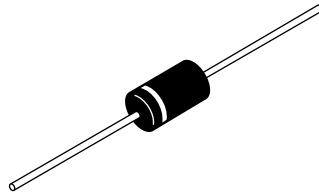

DO-204AL



### FEATURES

- Low profile, axial leaded outline
- Very low forward voltage drop
- High frequency operation
- High purity, high temperature epoxy encapsulation for enhanced mechanical strength and moisture resistance
- Guard ring for enhanced ruggedness and long term reliability
- Lead (Pb)-free plating
- Designed and qualified for industrial level

**RoHS**  
COMPLIANT

### PRODUCT SUMMARY

$I_{F(AV)}$	1 A
$V_R$	50/60 V
$I_{RM}$	10 mA at 125 °C

### DESCRIPTION

The MBR150, MBR160 axial leaded Schottky rectifier has been optimized for very low forward voltage drop, with moderate leakage. Typical applications are in switching power supplies, converters, freewheeling diodes, and reverse battery protection.

### MAJOR RATINGS AND CHARACTERISTICS

SYMBOL	CHARACTERISTICS	VALUES	UNITS
$I_{F(AV)}$	Rectangular waveform	1.0	A
$V_{RRM}$		50/60	V
$I_{FSM}$	$t_p = 5 \mu s$ sine	150	A
$V_F$	1 Apk, $T_J = 125 \text{ }^\circ\text{C}$	0.65	V
$T_J$	Range	- 40 to 150	$^\circ\text{C}$

### VOLTAGE RATINGS

PARAMETER	SYMBOL	MBR150	MBR160	UNITS
Maximum DC reverse voltage	$V_R$	50	60	V
Maximum working peak reverse voltage	$V_{RWM}$			

### ABSOLUTE MAXIMUM RATINGS

PARAMETER	SYMBOL	TEST CONDITIONS	VALUES	UNITS
Maximum average forward current See fig. 4	$I_{F(AV)}$	50 % duty cycle at $T_C = 75 \text{ }^\circ\text{C}$ , rectangular waveform	1.0	A
Maximum peak one cycle non-repetitive surge current See fig. 6	$I_{FSM}$	5 $\mu s$ sine or 3 $\mu s$ rect. pulse	150	
		10 ms sine or 6 ms rect. pulse	25	
Non-repetitive avalanche energy	$E_{AS}$	$T_J = 25 \text{ }^\circ\text{C}$ , $I_{AS} = 1 \text{ A}$ , $L = 4 \text{ mH}$	2.0	mJ
Repetitive avalanche current	$I_{AR}$	Current decaying linearly to zero in 1 $\mu s$ Frequency limited by, $T_J$ maximum $V_A = 1.5 \times V_R$ typical	1.0	A

ELECTRICAL SPECIFICATIONS					
PARAMETER	SYMBOL	TEST CONDITIONS		VALUES	UNITS
Maximum forward voltage drop See fig. 1	$V_{FM}^{(1)}$	1 A	$T_J = 25\text{ }^\circ\text{C}$	0.75	V
		2 A		0.9	
		3 A		1.0	
		1 A	$T_J = 125\text{ }^\circ\text{C}$	0.65	
		2 A		0.75	
		3 A		0.82	
Maximum reverse leakage current See fig. 2	$I_{RM}^{(1)}$	$T_J = 25\text{ }^\circ\text{C}$	$V_R = \text{Rated } V_R$	0.5	mA
		$T_J = 100\text{ }^\circ\text{C}$		5	
		$T_J = 125\text{ }^\circ\text{C}$		10	
Typical junction capacitance	$C_T$	$V_R = 5\text{ }V_{DC}$ (test signal range 100 kHz to 1 MHz) 25 °C		55	pF
Typical series inductance	$L_S$	Measured lead to lead 5 mm from package body		8.0	nH
Maximum voltage rate of change	dV/dt	Rated $V_R$		10 000	V/ $\mu$ s

**Note**

(1) Pulse width < 300  $\mu$ s, duty cycle < 2 %

THERMAL - MECHANICAL SPECIFICATIONS					
PARAMETER	SYMBOL	TEST CONDITIONS		VALUES	UNITS
Maximum junction and storage temperature range	$T_J^{(1)}, T_{Stg}$			- 40 to 150	$^\circ\text{C}$
Maximum thermal resistance, junction to lead	$R_{thJL}^{(2)}$	DC operation See fig. 4		80	$^\circ\text{C}/\text{W}$
Approximate weight				0.33	g
				0.012	oz.
Marking device		Case style DO-204AL (DO-41)		MBR150	
				MBR160	

**Notes**

(1)  $\frac{dP_{tot}}{dT_J} < \frac{1}{R_{thJA}}$  thermal runaway condition for a diode on its own heatsink

(2) Mounted 1" square PCB, thermal probe connected to lead 2 mm from package

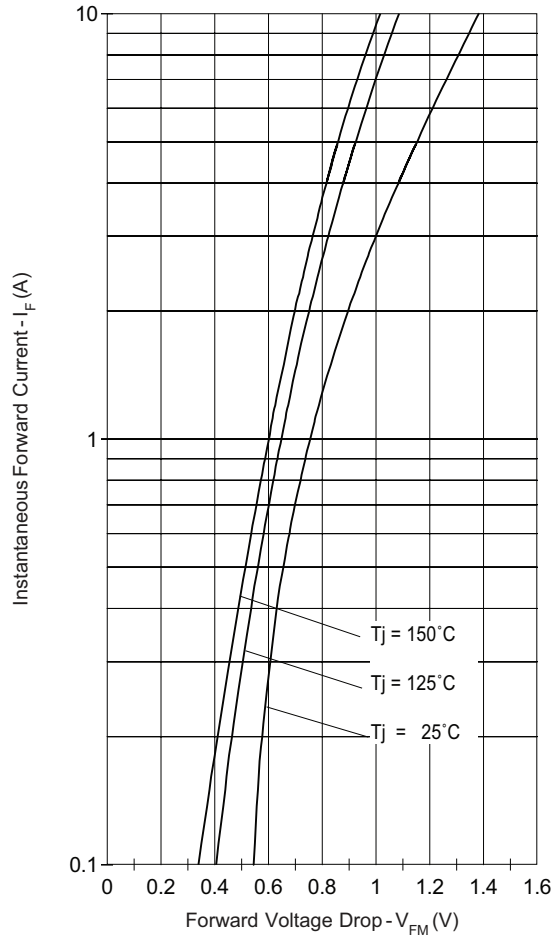

Fig. 1 - Maximum Forward Voltage Drop Characteristics

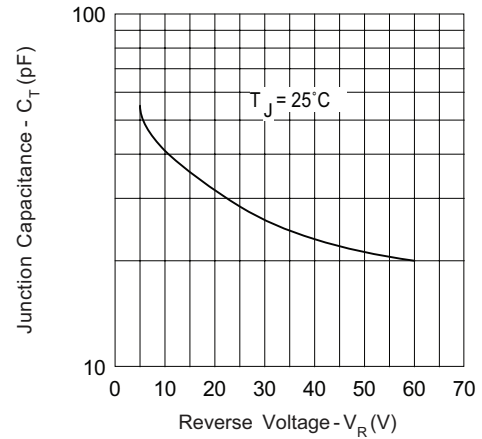

Fig. 3 - Typical Junction Capacitance vs. Reverse Voltage

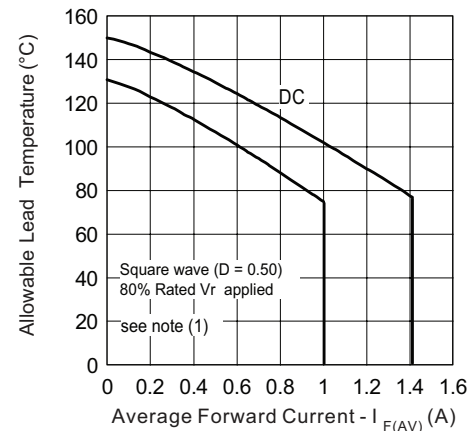

Fig. 4 - Maximum Ambient Temperature vs. Average Forward Current, Printed Circuit Board Mounted

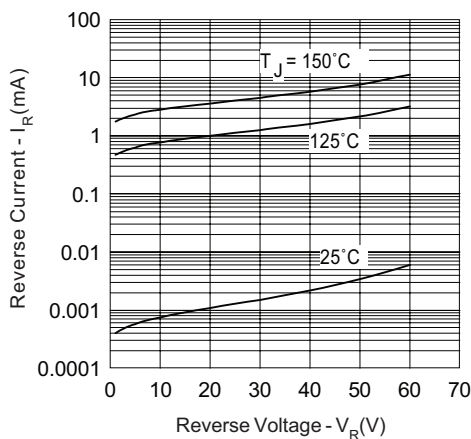

Fig. 2 - Typical Values of Reverse Current vs. Reverse Voltage

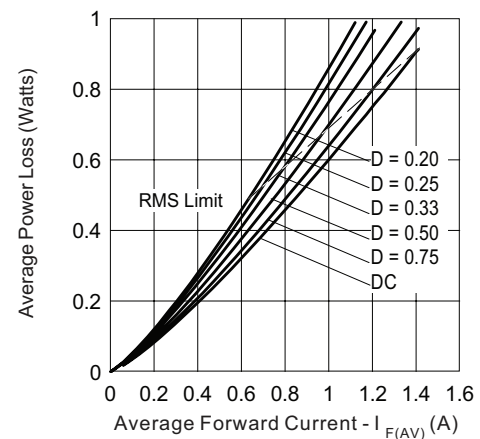

Fig. 5 - Forward Power Loss Characteristics

**Note**

(1) Formula used:  $T_C = T_J - (Pd + Pd_{REV}) \times R_{thJC}$ ;

$Pd$  = Forward power loss =  $I_{F(AV)} \times V_{FM}$  at  $(I_{F(AV)}/D)$  (see fig. 6);  $Pd_{REV}$  = Inverse power loss =  $V_{R1} \times I_R (1 - D)$ ;  $I_R$  at  $V_{R1} = 80\%$  rated  $V_R$

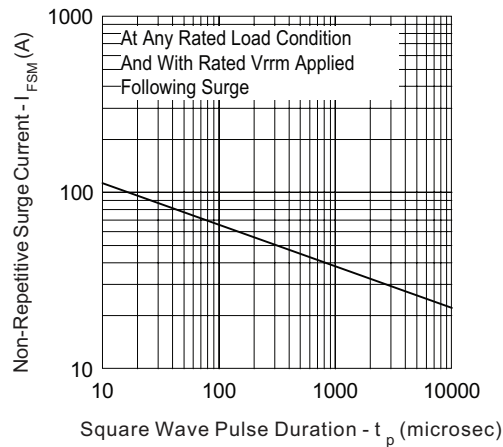

Fig. 6 - Maximum Non-Repetitive Surge Current

## ORDERING INFORMATION TABLE

Device code	<b>MBR</b>	<b>1</b>	<b>60</b>	<b>TR</b>
	①	②	③	④
	<b>1</b>	-	Schottky MBR series	
	<b>2</b>	-	Current rating: 1 = 1 A	
	<b>3</b>	-	Voltage rating	50 = 50 V 60 = 60 V
	<b>4</b>	-	TR = Tape and reel package (5000 pcs) None = Box package (1000 pcs)	

LINKS TO RELATED DOCUMENTS	
Dimensions	<a href="http://www.vishay.com/doc?95241">http://www.vishay.com/doc?95241</a>
Part marking information	<a href="http://www.vishay.com/doc?95304">http://www.vishay.com/doc?95304</a>
Packaging information	<a href="http://www.vishay.com/doc?95308">http://www.vishay.com/doc?95308</a>

## Axial DO-204AL (DO-41)

**DIMENSIONS** in millimeters (inches)

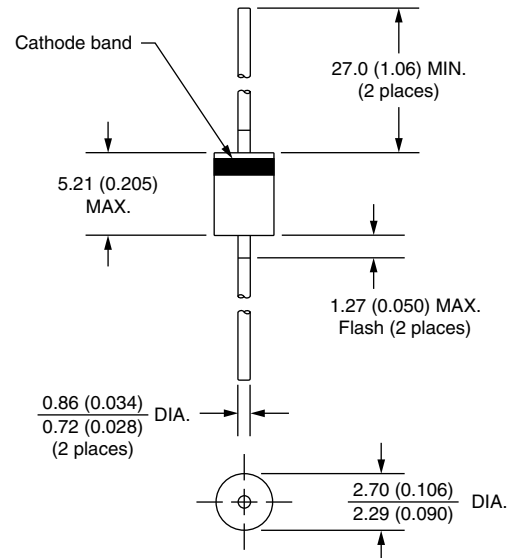
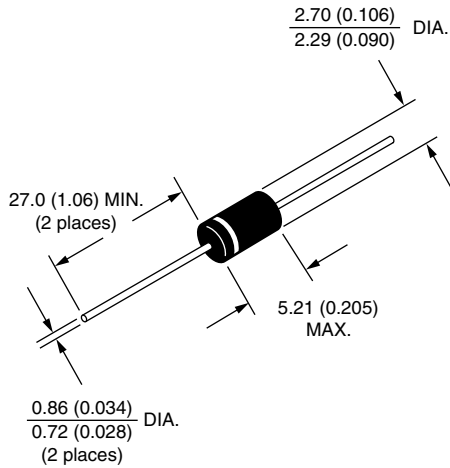



## Disclaimer

ALL PRODUCT, PRODUCT SPECIFICATIONS AND DATA ARE SUBJECT TO CHANGE WITHOUT NOTICE TO IMPROVE RELIABILITY, FUNCTION OR DESIGN OR OTHERWISE.

Vishay Intertechnology, Inc., its affiliates, agents, and employees, and all persons acting on its or their behalf (collectively, "Vishay"), disclaim any and all liability for any errors, inaccuracies or incompleteness contained in any datasheet or in any other disclosure relating to any product.

Vishay makes no warranty, representation or guarantee regarding the suitability of the products for any particular purpose or the continuing production of any product. To the maximum extent permitted by applicable law, Vishay disclaims (i) any and all liability arising out of the application or use of any product, (ii) any and all liability, including without limitation special, consequential or incidental damages, and (iii) any and all implied warranties, including warranties of fitness for particular purpose, non-infringement and merchantability.

Statements regarding the suitability of products for certain types of applications are based on Vishay's knowledge of typical requirements that are often placed on Vishay products in generic applications. Such statements are not binding statements about the suitability of products for a particular application. It is the customer's responsibility to validate that a particular product with the properties described in the product specification is suitable for use in a particular application. Parameters provided in datasheets and/or specifications may vary in different applications and performance may vary over time. All operating parameters, including typical parameters, must be validated for each customer application by the customer's technical experts. Product specifications do not expand or otherwise modify Vishay's terms and conditions of purchase, including but not limited to the warranty expressed therein.

Except as expressly indicated in writing, Vishay products are not designed for use in medical, life-saving, or life-sustaining applications or for any other application in which the failure of the Vishay product could result in personal injury or death. Customers using or selling Vishay products not expressly indicated for use in such applications do so at their own risk and agree to fully indemnify and hold Vishay and its distributors harmless from and against any and all claims, liabilities, expenses and damages arising or resulting in connection with such use or sale, including attorneys fees, even if such claim alleges that Vishay or its distributor was negligent regarding the design or manufacture of the part. Please contact authorized Vishay personnel to obtain written terms and conditions regarding products designed for such applications.

No license, express or implied, by estoppel or otherwise, to any intellectual property rights is granted by this document or by any conduct of Vishay. Product names and markings noted herein may be trademarks of their respective owners.