

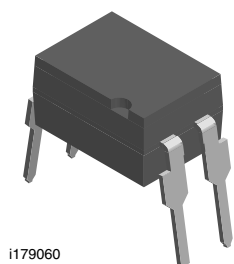

Optocoupler, Photodarlington Output

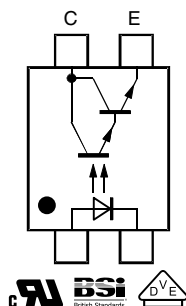

i179060



FEATURES

- High isolation test voltage 5300 V_{RMS}
- Standard plastic DIP-4 package
- Material categorization:
for definitions of compliance please see
www.vishay.com/doc?99912

RoHS
COMPLIANT

AGENCY APPROVALS

- UL - file no. E52744 system code H, double protection
- DIN EN 60747-5-2 (VDE 0884), IEC 60747-5-5
- DIN EN 60747-5-5 (VDE 0884) pending
- BSI IEC 60950; IEC 60065

DESCRIPTION

The SFH655A is optically coupled isolators with a gallium arsenide infrared LED and a silicon photodarlington detector. Switching can be achieved while maintaining a high degree of isolation between driving and load circuits.

This optocouplers can be used to replace reed and mercury relays with advantages of long life, high speed switching and elimination of magnetic fields.

ORDERING INFORMATION

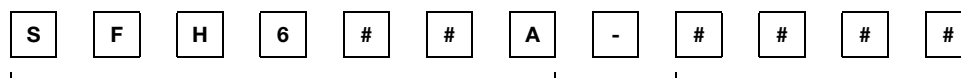

PART NUMBER

PACKAGE OPTION

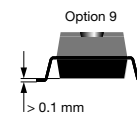
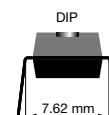

AGENCY CERTIFIED/PACKAGE	CTR (%)
cUL, VDE	> 600
DIP-4	SFH655A
SMD-4, option 9	SFH655A-X009

Note

- For additional information on the available options refer to option information

ABSOLUTE MAXIMUM RATINGS (T_{amb} = 25 °C, unless otherwise specified)

PARAMETER	TEST CONDITION	SYMBOL	VALUE	UNIT
INPUT				
Peak reverse voltage		V _{RM}	6	V
Forward continuous current		I _F	60	mA
Surge forward current	t _p ≤ 10μs	I _{FSM}	2.5	A
Derate linearly from 25 °C			1.33	mW/°C
Power dissipation		P _{diss}	100	mW
OUTPUT				
Collector emitter breakdown voltage		BV _{CEO}	55	V
Emitter collector breakdown voltage		BV _{ECO}	6	V
Collector (load) current		I _C	125	mA
Derate linearly from 25 °C			2	mW/°C
Power dissipation		P _{diss}	150	mW



ABSOLUTE MAXIMUM RATINGS ($T_{amb} = 25\text{ }^{\circ}\text{C}$, unless otherwise specified)				
PARAMETER	TEST CONDITION	SYMBOL	VALUE	UNIT
COUPLER				
Derate linearly from 25 °C			3.33	mW/°C
Total power dissipation		P_{tot}	250	mW
Storage temperature range		T_{stg}	-55 to +150	°C
Operating temperature range		T_{amb}	-55 to +100	°C
Soldering temperature ⁽¹⁾	max. 10 s, dip soldering distance to seating plane ≥ 1.5 mm	T_{sld}	260	°C

Notes

- Stresses in excess of the absolute maximum ratings can cause permanent damage to the device. Functional operation of the device is not implied at these or any other conditions in excess of those given in the operational sections of this document. Exposure to absolute maximum ratings for extended periods of the time can adversely affect reliability
- ⁽¹⁾ Refer to reflow profile for soldering conditions for surface mounted devices (SMD). Refer to wave profile for soldering conditions for through hole devices (DIP)

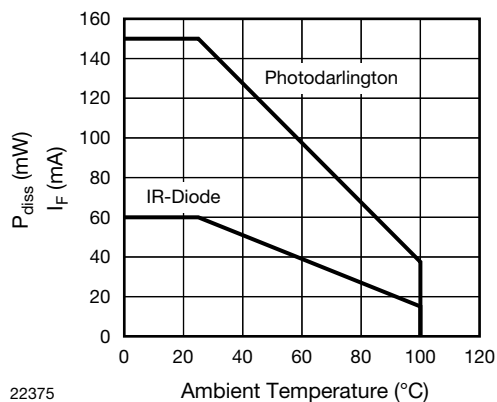

Fig. 1 - Power Dissipation vs. Ambient Temperature

ELECTRICAL CHARACTERISTICS ($T_{amb} = 25\text{ }^{\circ}\text{C}$, unless otherwise specified)							
PARAMETER	TEST CONDITION	PART	SYMBOL	MIN.	TYP.	MAX.	UNIT
INPUT							
Forward voltage	$I_F = 10\text{ mA}$		V_F	-	1.15	1.5	V
Reverse current	$V_R = 6\text{ V}$		I_R	-	0.02	10	μA
Capacitance	$V_R = 0\text{ V}$, $f = 1\text{ MHz}$		C_O	-	50	-	pF
OUTPUT							
Collector emitter breakdown voltage	$I_{CE} = 100\text{ }\mu\text{A}$		BV_{CEO}	55	-	-	V
Emitter collector breakdown voltage	$I_{EC} = 10\text{ }\mu\text{A}$		BV_{ECO}	6	-	-	V
Collector emitter dark current	$V_{CE} = 40\text{ V}$		I_{CEO}	-	12	400	nA
Collector emitter capacitance	$V_{CE} = 0\text{ V}$, $f = 1\text{ MHz}$		C_{CE}	-	13.5	-	pF
COUPLER							
Collector emitter saturation voltage	$I_F = 20\text{ mA}$, $I_C = 5\text{ mA}$	SFH655A	V_{CEsat}	-	-	1	V
Coupling capacitance	$V_{I-O} = 0\text{ V}$, $f = 1\text{ MHz}$		C_C	-	0.45	-	pF

Note

- Minimum and maximum values are testing requirements. Typical values are characteristics of the device and are the result of engineering evaluation. Typical values are for information only and are not part of the testing requirements



CURRENT TRANSFER RATIO ($T_{amb} = 25\text{ }^{\circ}\text{C}$, unless otherwise specified)							
PARAMETER	TEST CONDITION	PART	SYMBOL	MIN.	TYP.	MAX.	UNIT
Current transfer ratio	$I_F = 1\text{ mA}$, $V_{CE} = 2\text{ V}$	SFH655A	CTR	600	-	-	%

SAFETY AND INSULATION RATINGS				
PARAMETER	TEST CONDITION	SYMBOL	VALUE	UNIT
Climatic classification	According to IEC 68 part 1		55 / 100 / 21	
Comparative tracking index		CTI	175	
Maximum rated withstanding isolation voltage	$t = 1\text{ min}$	V_{ISO}	4420	V_{RMS}
Maximum transient isolation voltage		V_{IOTM}	10 000	V
Maximum repetitive peak isolation voltage		V_{IORM}	890	V
Isolation resistance	$V_{IO} = 500\text{ V}$, $T_{amb} = 25\text{ }^{\circ}\text{C}$	R_{IO}	$\geq 10^{12}$	Ω
	$V_{IO} = 500\text{ V}$, $T_{amb} = 100\text{ }^{\circ}\text{C}$	R_{IO}	$\geq 10^{11}$	Ω
	$V_{IO} = 500\text{ V}$, $T_{amb} = 150\text{ }^{\circ}\text{C}$ (construction test only)	R_{IO}	$\geq 10^9$	Ω
Output safety power		P_{SO}	400	mW
Input safety current		I_{SI}	275	mA
Input safety temperature		T_{SI}	175	$^{\circ}\text{C}$
Creepage distance	Standard DIP-4		≥ 7	mm
Clearance distance	Standard DIP-4		≥ 7	mm
Insulation thickness		DTI	≥ 0.4	mm
Partial discharge test voltage - routine test	100 %, $t_{test} = 1\text{ s}$	V_{pd}	1.669	kV
Partial discharge test voltage - lot test (sample test)	$t_{Tr} = 60\text{ s}$, $t_{test} = 10\text{ s}$, (see fig. 2)	V_{pd}	1.424	kV

Note

- As per IEC 60747-5-5, § 7.4.3.8.2, this optocoupler is suitable for "safe electrical insulation" only within the safety ratings. Compliance with the safety ratings shall be ensured by means of protective circuits

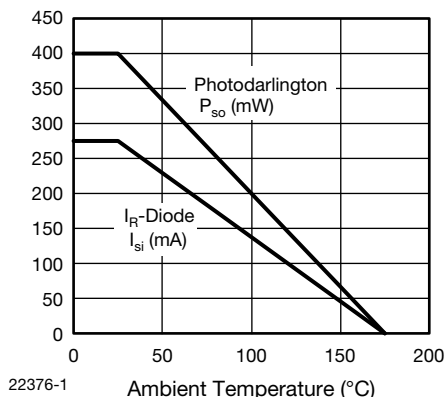

Fig. 2 - Derating Diagram

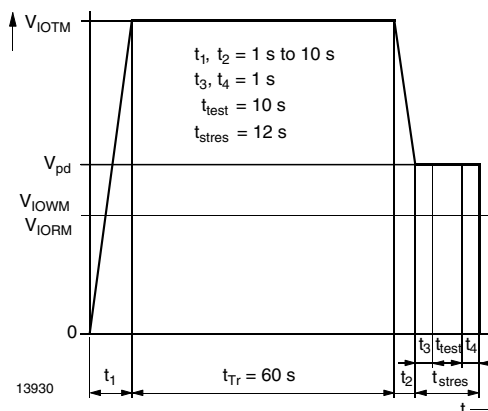

Fig. 3 - Test Pulse Diagram for Sample Test according to DIN EN 60747-5-2 (VDE 0884); IEC 60747-5-5



SWITCHING CHARACTERISTICS ($T_{amb} = 25\text{ }^{\circ}\text{C}$, unless otherwise specified)							
PARAMETER	TEST CONDITION	PART	SYMBOL	MIN.	TYP.	MAX.	UNIT
Turn-on time (fig. 10, test circuit 1)	$V_{CC} = 10\text{ V}$, $I_C = 2\text{ mA}$, $R_L = 100\ \Omega$	SFH612A	t_{on}		16		μs
Turn-off time (fig. 10, test circuit 1)	$V_{CC} = 10\text{ V}$, $I_C = 2\text{ mA}$, $R_L = 100\ \Omega$	SFH612A	t_{off}		15		μs
Rise time (fig. 10, test circuit 1)	$V_{CC} = 10\text{ V}$, $I_C = 2\text{ mA}$, $R_L = 100\ \Omega$	SFH612A	t_r		14		μs
Fall time (fig. 10, test circuit 1)	$V_{CC} = 10\text{ V}$, $I_C = 2\text{ mA}$, $R_L = 100\ \Omega$	SFH612A	t_f		14		μs
Turn-on time (fig. 11, test circuit 2)	$V_{CC} = 2\text{ V}$, $I_C = 10\text{ mA}$, $R_L = 100\ \Omega$	SFH655A	t_{on}		31		μs
Turn-off time (fig. 11, test circuit 2)	$V_{CC} = 2\text{ V}$, $I_C = 10\text{ mA}$, $R_L = 100\ \Omega$	SFH655A	t_{off}		55		μs
Rise time (fig. 11, test circuit 2)	$V_{CC} = 2\text{ V}$, $I_C = 10\text{ mA}$, $R_L = 100\ \Omega$	SFH655A	t_r		27	250	μs
Fall time (fig. 11, test circuit 2)	$V_{CC} = 2\text{ V}$, $I_C = 10\text{ mA}$, $R_L = 100\ \Omega$	SFH655A	t_f		56	200	μs

TYPICAL CHARACTERISTICS ($T_{amb} = 25\text{ }^{\circ}\text{C}$, unless otherwise specified)

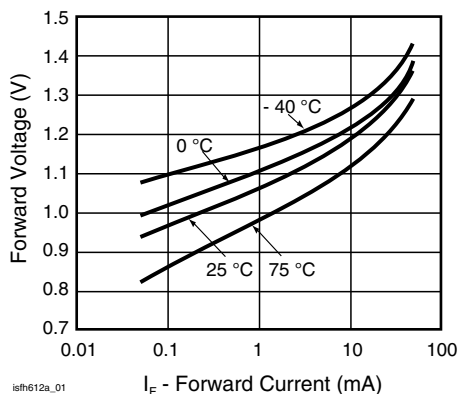

Fig. 4 - Forward Voltage vs. Forward Current

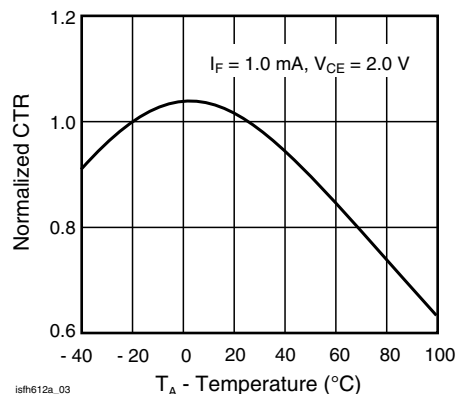

Fig. 6 - Normalized CTR vs. Temperature

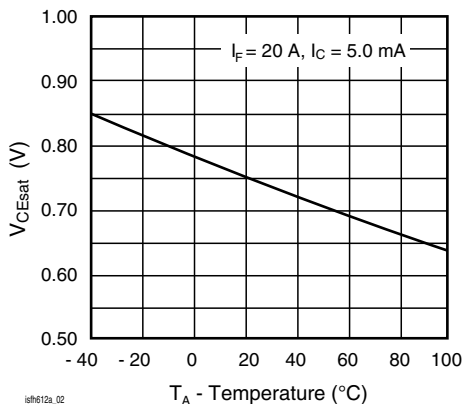

Fig. 5 - Collector Emitter Saturation Voltage vs. Temperature

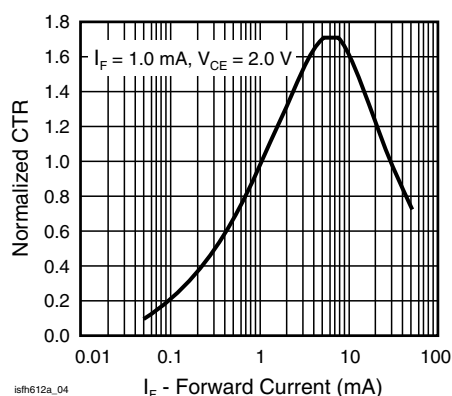

Fig. 7 - Normalized CTR vs. Forward Current

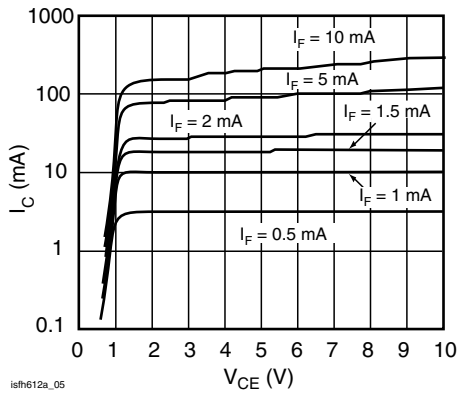

Fig. 8 - Collector Current vs. Collector Emitter Voltage

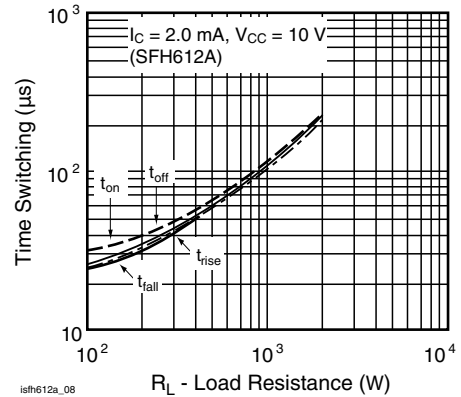

Fig. 11 - Switching Time vs. Load Resistor

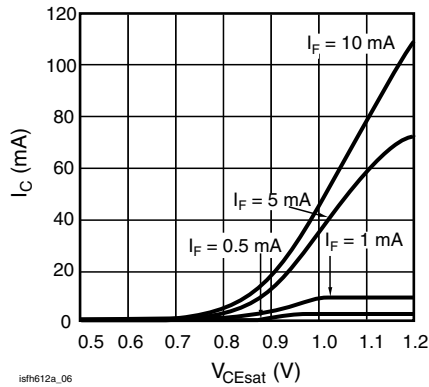

Fig. 9 - Collector Current vs. Collector Emitter Saturation Voltage

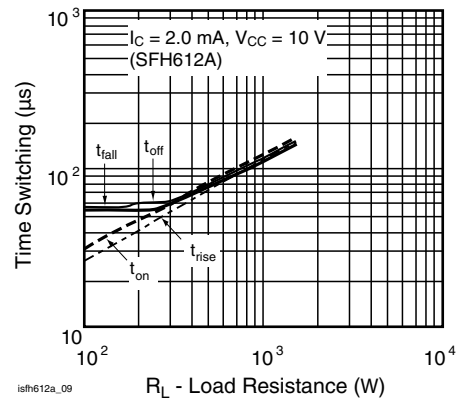

Fig. 12 - Switching Time vs. Load Resistor

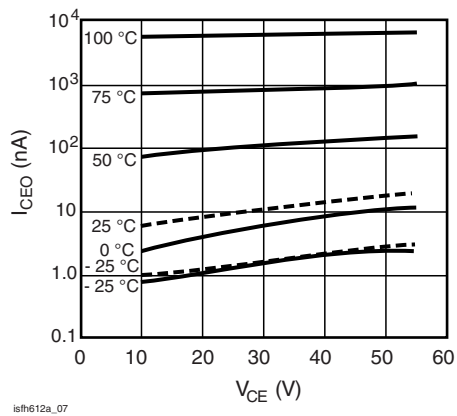
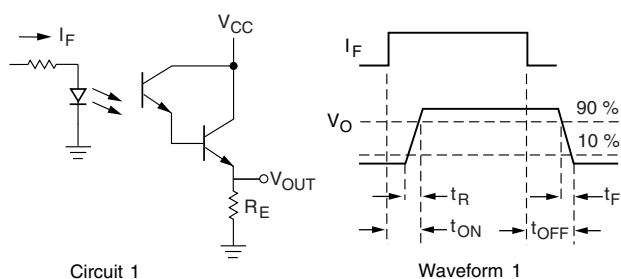

Fig. 10 - Collector Emitter Dark Current vs. Collector Emitter Voltage over Temperature



Circuit 1

Waveform 1

isfh612a_10

Fig. 13 - Switching Time Test Circuit and Waveforms

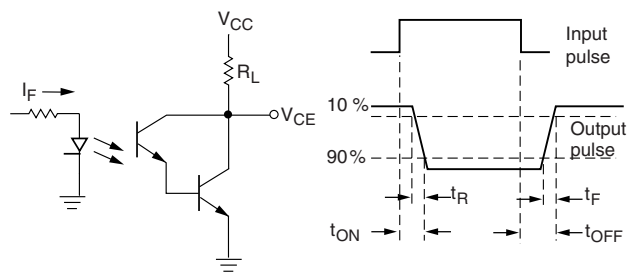

Circuit 2

Waveform 2

isfh612a_11

Fig. 14 - Switching Time Test Circuit and Waveforms

PACKAGE DIMENSIONS in millimeters

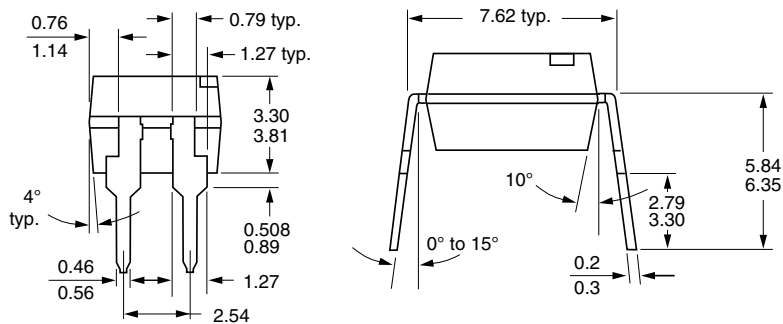
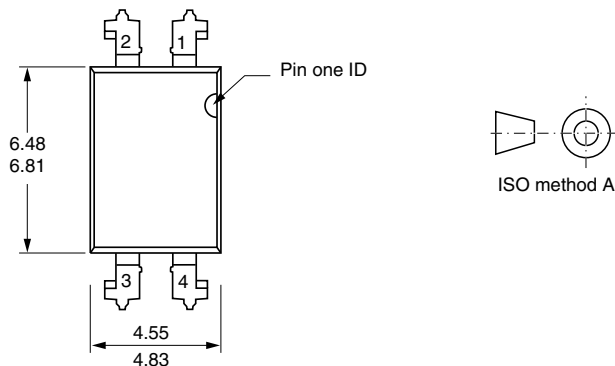

i178027

Option 9

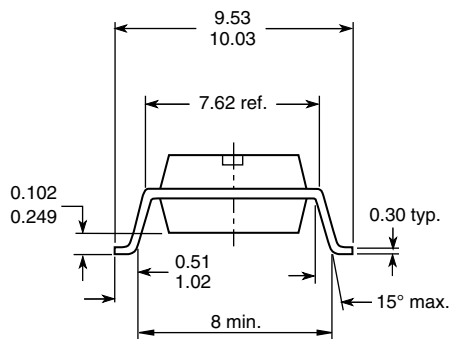

18449



PACKAGE MARKING

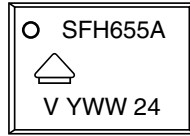

Note

- VDE logo is only printed on option 1 parts. Option information is not marked on the part



Footprint and Schematic Information for SFH655A

The footprint and schematic symbols for the following parts can be accessed using the associated links. They are available in Eagle, Altium, KiCad, OrCAD / Allegro, Pulsonix, and PADS.

Note that the 3D models for these parts can be found on the Vishay product page.

PART NUMBER	FOOTPRINT / SCHEMATIC
SFH655A	www.snapeda.com/parts/SFH655A/Vishay/view-part
SFH655A-X009	www.snapeda.com/parts/SFH655A-X009/Vishay/view-part

For technical issues and product support, please contact optocoupleranswers@vishay.com.

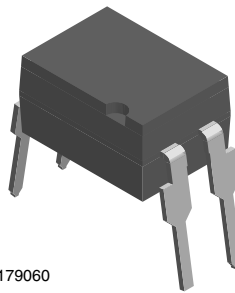



Disclaimer

ALL PRODUCT, PRODUCT SPECIFICATIONS AND DATA ARE SUBJECT TO CHANGE WITHOUT NOTICE TO IMPROVE RELIABILITY, FUNCTION OR DESIGN OR OTHERWISE.

Vishay Intertechnology, Inc., its affiliates, agents, and employees, and all persons acting on its or their behalf (collectively, "Vishay"), disclaim any and all liability for any errors, inaccuracies or incompleteness contained in any datasheet or in any other disclosure relating to any product.

Vishay makes no warranty, representation or guarantee regarding the suitability of the products for any particular purpose or the continuing production of any product. To the maximum extent permitted by applicable law, Vishay disclaims (i) any and all liability arising out of the application or use of any product, (ii) any and all liability, including without limitation special, consequential or incidental damages, and (iii) any and all implied warranties, including warranties of fitness for particular purpose, non-infringement and merchantability.

Statements regarding the suitability of products for certain types of applications are based on Vishay's knowledge of typical requirements that are often placed on Vishay products in generic applications. Such statements are not binding statements about the suitability of products for a particular application. It is the customer's responsibility to validate that a particular product with the properties described in the product specification is suitable for use in a particular application. Parameters provided in datasheets and / or specifications may vary in different applications and performance may vary over time. All operating parameters, including typical parameters, must be validated for each customer application by the customer's technical experts. Product specifications do not expand or otherwise modify Vishay's terms and conditions of purchase, including but not limited to the warranty expressed therein.

Except as expressly indicated in writing, Vishay products are not designed for use in medical, life-saving, or life-sustaining applications or for any other application in which the failure of the Vishay product could result in personal injury or death. Customers using or selling Vishay products not expressly indicated for use in such applications do so at their own risk. Please contact authorized Vishay personnel to obtain written terms and conditions regarding products designed for such applications.

No license, express or implied, by estoppel or otherwise, to any intellectual property rights is granted by this document or by any conduct of Vishay. Product names and markings noted herein may be trademarks of their respective owners.