

(Ø3.5mm DC PLUG DETAIL DRWING)

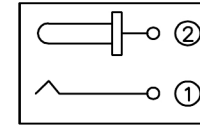

SCHEMATIC

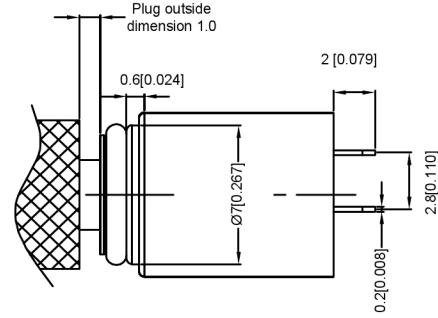
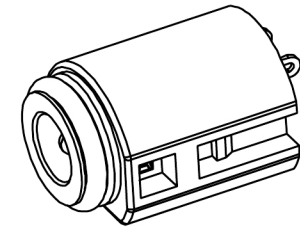

3D VIEW

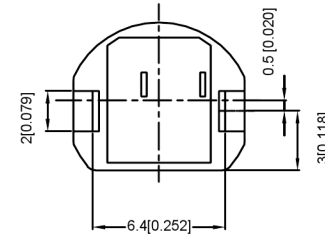
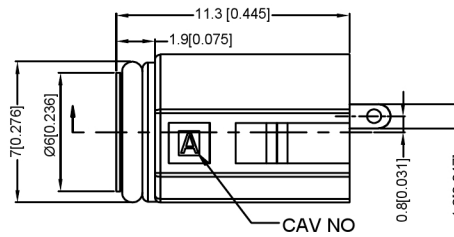

NOTES:

- 注释:
 1. CONTACT CURRENT RATING: 1.5A.
 触点额定电流: 1.5A.
 2. CONTACT RESISTANCE: 60 mΩ MAX.
 接触电阻: 最大60 mΩ.
 3. INSULATION RESISTANCE: 100MΩ MIN.
 绝缘电阻: 最小100MΩ.
 4. DIELECTRIC WITHSTANDING: 500V AC MIN.
 耐介质: 最小500V AC.
 5. DURABILITY: 5,000 CYCLES MIN..
 耐久性: 至少5,000次循环。
 6. CONNECTOR MATING FORCES: 2.94~29.4N (0.30~3.00Kgf);
 连接器配合力: 2.94~29.4N (0.30~3.00Kgf);
 7. CONNECTOR UNMATING FORCES: 2.94~29.4N (0.30~3.00Kgf)
 连接器脱离力: 2.94~29.4N (0.30~3.00Kgf)
 8. WATERPROOF STRENGTH: IP-X7
 防水强度: IP-X7

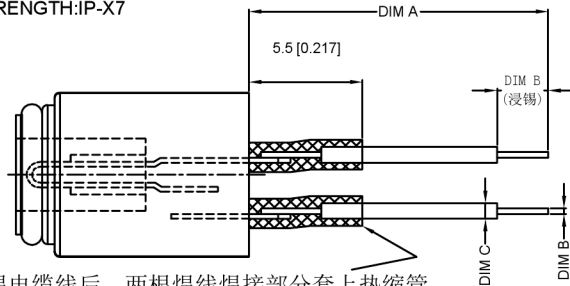
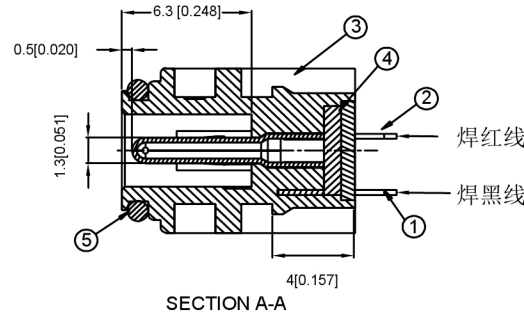
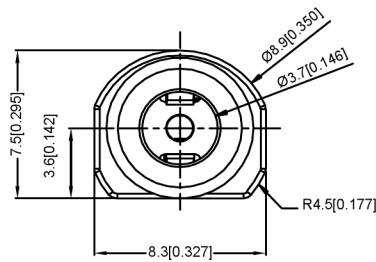

焊电缆线后, 两根焊线焊接部分套上热缩管
 焊电缆线图

	MATERIAL	PLATING
	plastic	Pa66
	bond	
	center pin	Brass tin
	terminal 2	Brass tin
	terminal 3	Phosphor Bronze tin

广东星坤科技股份有限公司

ΔX	日期
ΔX	日期
ΔX	日期
MARK	DESCRIPTION

文件工程章

REVISIONS	DATE	REVISED	APPROVED	UNSPECIFIED TOLERANCES
ANGLAR		±5°		
L ≤ 4		±0.2		
4 < L ≤ 16		±0.3		
16 < L ≤ 63		±0.4		
L > 63		±0.5		



DSND	SCALE: N/A	MODEL TYPE: DC POWER JACK
DWN	VIEW:	PART NO.: DC-F745
CHKD	UNIT: mm/in	DWG NO.:
APPD	SIZE: A4	

XKB INDUSTRIAL PRECISION CO., LIMITED

WEIGHT	SHEET	REVISI
	1/1	A0