

P . C . B LAYOUT

Specifications:
 规格:
 Voltage rating:250V AC/DC
 额定电压: 250V AC/DC
 Current rating:1A AC/DC
 额定电流: 1A AC/DC
 Withstanding voltage:500V AC/minute
 耐受电压: 500V AC/分钟
 Temperature range:-40°C--+105°C
 温度范围: -40°C--+105°C
 Insulation resistance: 1000MΩ min
 绝缘电阻: 1000MΩ Min
 Contact resistance:20mΩ Max
 接触电阻: 20mΩ Max

- X2001 W V - 2xXX A - 6T V01
 ① ② ③ ④ ⑤ ⑥ ⑦
 1.Series No
 2.Category:W-Wafer
 3.Welding Board Angle:V-Straight 180°
 4.Row No.Pin No:2xXX-2x03-2x32P
 5.Category:A-No gap
 6.Material:6T-Nylon 6T UL94V-0
 7.Plating:V01-Gold Flash

Poles	Dimensions		Poles	Dimensions	
	A	B		A	B
2x03	4.00	13.30	2x12	22.00	31.30
2x04	6.00	15.30	2x13	24.00	33.30
2x05	8.00	17.30	2x15	28.00	37.30
2x06	10.00	19.30	2x17	32.00	41.30
2x07	12.00	21.30	2x20	38.00	47.30
2x08	14.00	23.30	2x22	42.00	51.30
2x09	16.00	25.30	2x25	48.00	57.30
2x10	18.00	27.30	2x30	58.00	67.30
2x11	20.00	29.30	2x32	62.00	71.30

X2001WV-2xXXA-6TV01	Nylon 6T	Brass	X2001H / X2001H2
PART NO	Material	Material(Pin)	Suitable XKB IDC

广东星坤科技股份有限公司

DATE	DATE	REVISED	APPROVED
DATE	DATE	REVISED	APPROVED
DATE	DATE	REVISED	APPROVED

文件工程章

DESCRIPTION	DATE	REVISED	APPROVED	UNSPECIFIED TOLERANCES

DSND
DWN
CHKD
APPD

SCALE: N/A
VIEW:

UNIT: mm/in
SIZE: A4

MODEL TYPE:
2.0mm Crimp Style Connector
PART NO.:
X2001WV-2xXXA-6TV01
DWG NO.:
X-X2001WV-2xXXA-6TV01

WEIGHT SHEET REVISION
1/1 A0

XKB INDUSTRIAL PRECISION CO., LIMITED

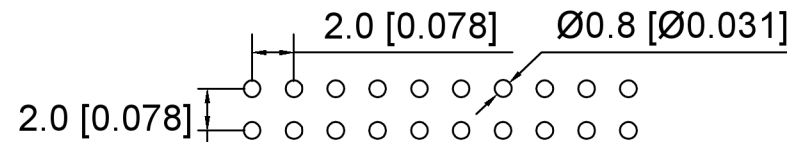
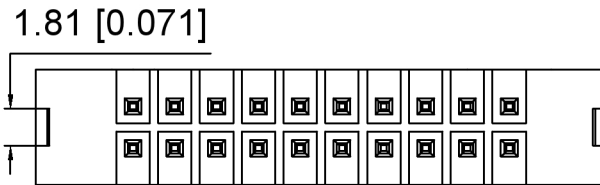
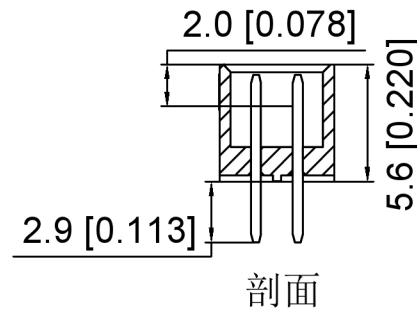
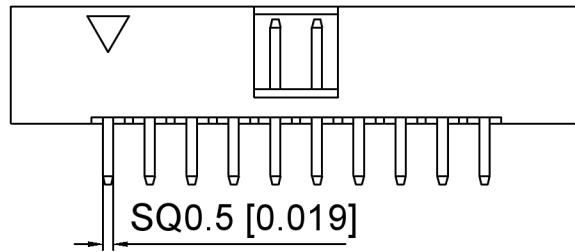
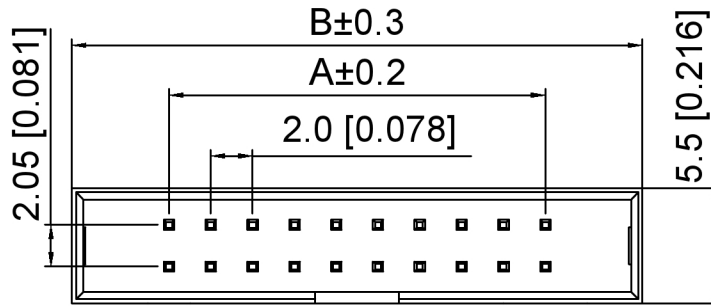

P . C . B LAYOUT

Specifications:

规格:

- Voltage rating: 250V AC/DC
- 额定电压: 250V AC/DC
- Current rating: 1A AC/DC
- 额定电流: 1A AC/DC
- Withstanding voltage: 500V AC/minute
- 耐受电压: 500V AC/分钟
- Temperature range: -40°C +105°C
- 温度范围: -40°C +105°C
- Insulation resistance: 1000MΩ min
- 绝缘电阻: 1000MΩ Min
- Contact resistance: 20mΩ Max
- 接触电阻: 20mΩ Max

X2001 W V - 2xXX B - 6T V01
 ① ② ③ ④ ⑤ ⑥ ⑦

1. Series No
2. Category: W-Wafer
3. Welding Board Angle: V-Stright 180°
4. Row No. Pin No: 2xXX-2x03-2x32P
5. Category: B-have gaps
6. Material: 6T-Nylon 6T UL94V-0
7. Plating: V01-Gold Flash

Poles	Dimensions		Poles	Dimensions	
	A	B		A	B
2x03	4.00	13.30	2x13	24.00	33.30
2x04	6.00	15.30	2x15	28.00	37.30
2x05	8.00	17.30	2x17	32.00	41.30
2x06	10.00	19.30	2x20	38.00	47.30
2x07	12.00	21.30	2x22	42.00	51.30
2x08	14.00	23.30	2x25	48.00	57.30
2x09	16.00	25.30	2x30	58.00	67.30
2x10	18.00	27.30	2x32	62.00	71.30
2x12	20.00	31.30	/		

X2001WV-2xXXB-6TV01	Nylon 6T	Brass	X2001H3 / X2001HA3
PART NO	Material	Material(Pin)	Suitable XKB IDC

DSND	SCALE: N/A	MODEL TYPE:
DWN	VIEW:	2.0mm Crimp Style Connector
CHKD	UNIT: mm/in	PART NO.:
APPD	SIZE: A4	X2001WV-2xXXB-6TV01
		DWG NO.:
		X-X2001WV-2xXXB-6TV01



XKB INDUSTRIAL PRECISION CO., LIMITED

WEIGHT	SHEET	REVISION
	1/1	A0

广东星坤科技股份有限公司

Δx	日期
Δx	
Δx	
MARK	DESCRIPTION

文件工程章

REVISIONS	DATE	REVISED	APPROVED	UNSPECIFIED TOLERANCES
ANGLAR				±5°
L ≤ 4				±0.2
4 < L ≤ 16				±0.3
16 < L ≤ 63				±0.4
L > 63				±0.5

www.helloxkb.com www.helloxkb.cn www.xk-dg.cn

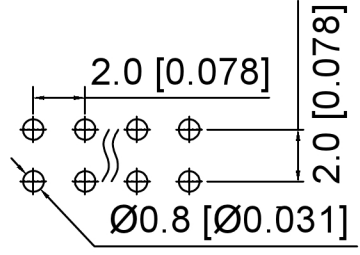
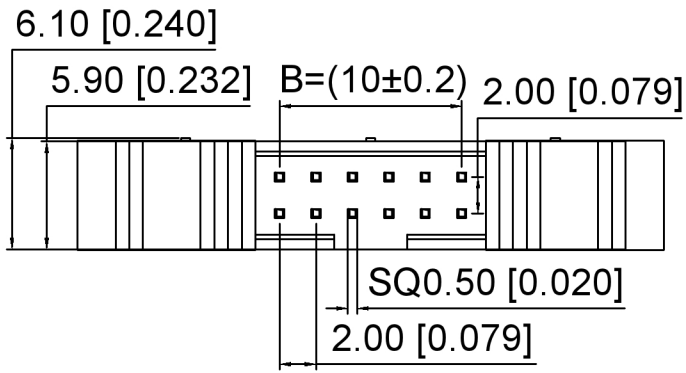

PCB Layout

Specifications:
 规格:
 Voltage rating:250V AC/DC
 额定电压: 250V AC/DC
 Current rating:1A AC/DC
 额定电流: 1A AC/DC
 Withstanding voltage:500V AC/minute
 耐受电压: 500V AC/分钟
 Temperature range:-40℃+105℃
 温度范围: -40℃+105℃
 Insulation resistance: 1000MΩ min
 绝缘电阻: 1000MΩ Min
 Contact resistance:20mΩ Max
 接触电阻: 20mΩ Max

X2001 W V - 2xXX C - 6T V01
 ① ② ③ ④ ⑤ ⑥ ⑦

- 1.Series No
- 2.Category:W-Wafer
- 3.Welding Board Angle:V-Stright 180°
- 4.Row No.Pin No.:2xXX-2x03-2x32P
- 5.Category:C-long ears
- 6.Material:6T-Nylon 6T UL94V-0
- 7.Plating:V01-Gold Flash

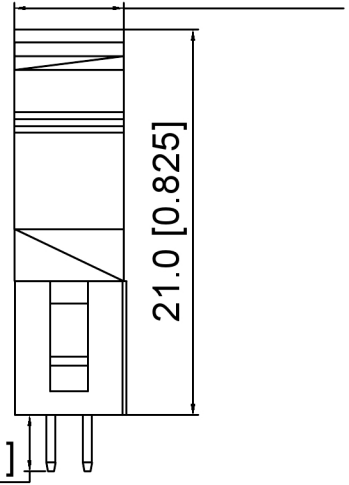
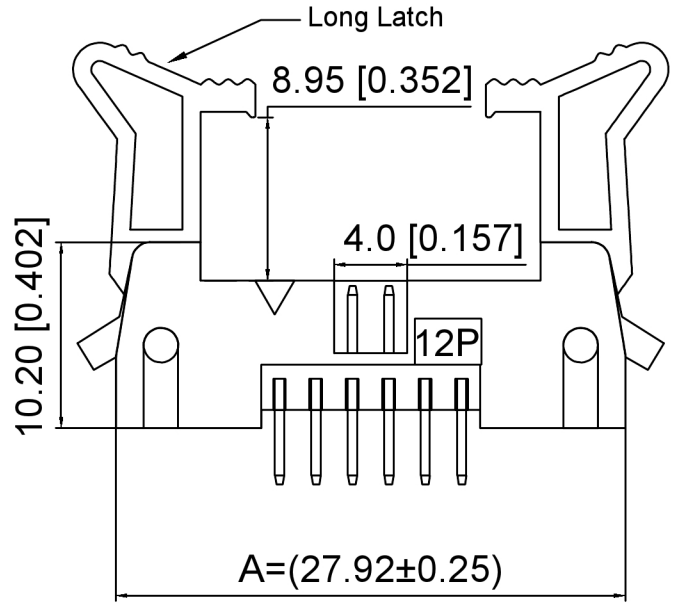

$$A = 2.0 * \frac{NP}{2} + 15.92 \pm 0.25$$

$$B = 2.0 * \frac{NP}{2} - 2.0 \pm 0.2$$

Poles	Dimensions		Poles	Dimensions	
	A	B		A	B
2x03	21.92	4.00	2x13	41.92	24.00
2x04	23.92	6.00	2x15	45.92	28.00
2x05	25.92	8.00	2x17	49.92	32.00
2x06	27.92	10.00	2x20	55.92	38.00
2x07	29.92	12.00	2x22	59.92	42.00
2x08	31.92	14.00	2x25	65.92	48.00
2x10	35.92	18.00	2x30	75.92	58.00
2x12	39.92	22.00	2x32	79.92	62.00

X2001WV-2xXXC-6TV01	Nylon 6T	Brass	X2001H2
PART NO	Material	Material(Pin)	Suitable XKB IDC

广东星坤科技股份有限公司
 文件工程章

REVISIONS	DESCRIPTION	DATE	REVISED	APPROVED	UNSPECIFIED TOLERANCES
ANGLAR					±5°
L ≤ 4					±0.2
4 < L ≤ 16					±0.3
16 < L ≤ 63					±0.4
L > 63					±0.5

XKB	DSND	SCALE: N/A	MODEL TYPE:
	DWN	VIEW:	2.0mm Crimp Style Connector
	CHKD	UNIT: mm/in	PART NO.:
	APPD	SIZE: A4	X2001WV-2xXXC-6TV01
XKB INDUSTRIAL PRECISION CO., LIMITED			DWG NO.:
			X-X2001WV-2xXXC-6TV01
		WEIGHT	SHEET
		1/1	REVISION
			A0

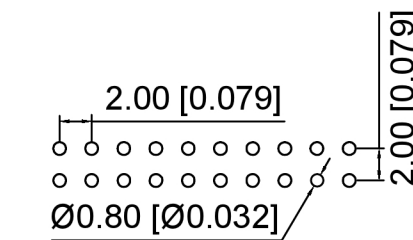
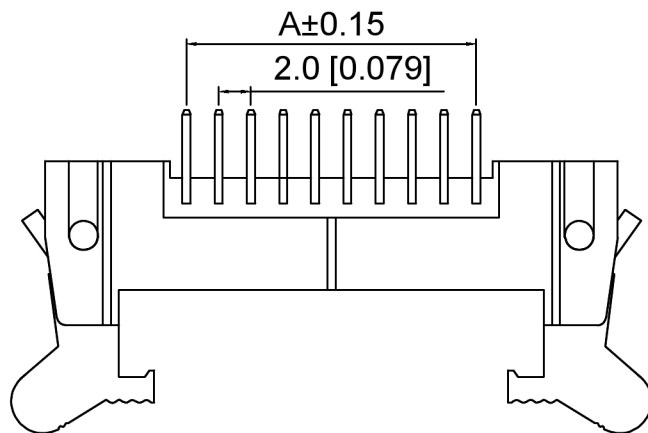
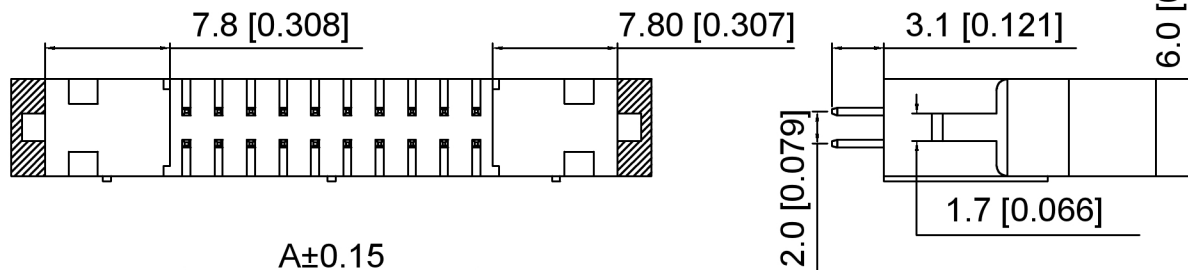
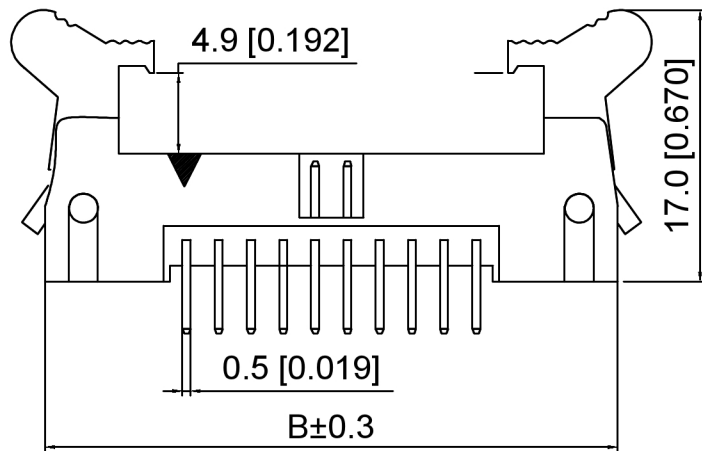

Specifications:

规格:

Voltage rating:250V AC/DC
 额定电压: 250V AC/DC
 Current rating:1A AC/DC
 额定电流: 1A AC/DC
 Withstanding voltage:500V AC/minute
 耐受电压: 500V AC/分钟
 Temperature range:-40°C-+105°C
 温度范围: -40°C-+105°C
 Insulation resistance: 1000MΩ min
 绝缘电阻: 1000MΩ Min
 Contact resistance:20mΩ Max
 接触电阻: 20mΩ Max

X2001 W V - 2xXX D - 6T V01
 ① ② ③ ④ ⑤ ⑥ ⑦

- 1.Series No
- 2.Category:W-Wafer
- 3.Welding Board Angle:V-Stright 180°
- 4.Row No.Pin No :2xXX-2x03-2x30P
- 5.Category:D-Short ears
- 6.Material:6T-Nylon 6T UL94V-0
- 7.Plating:V01-Gold Flash

Poles	Dimensions		Poles	Dimensions	
	A	B		A	B
2x03	4.00	21.60	2x13	24.00	41.60
2x04	6.00	23.60	2x15	28.00	45.60
2x05	8.00	25.60	2x17	32.00	49.60
2x06	10.00	27.60	2x20	38.00	55.60
2x07	12.00	29.60	2x22	42.00	59.60
2x08	14.00	31.60	2x25	48.00	65.60
2x10	18.00	35.60	2x30	58.00	75.60
2x12	22.00	39.60	/		

X2001WV-2xXXD-6TV01	Nylon 6T	Brass	X2001H
PART NO	Material	Material(Pin)	Suitable XKB IDC

广东星坤科技股份有限公司
 文件工程章

REVISIONS	DATE	REVISED	APPROVED	UNSPECIFIED TOLERANCES
ANGLAR				±5°
L ≤ 4				±0.2
4 < L ≤ 16				±0.3
16 < L ≤ 63				±0.4
L > 63				±0.5

DSND	SCALE: N/A	MODEL TYPE: 2.0mm Crimp Style Connector
DWN	VIEW:	PART NO.: X2001WV-2xXXD-6TV01
CHKD	UNIT: mm/in	DWG NO.: X-X2001WV-2xXXD-6TV01
APPD	SIZE: A4	WEIGHT
XKB INDUSTRIAL PRECISION CO., LIMITED		SHEET
		REVISION
		1/1
		A0

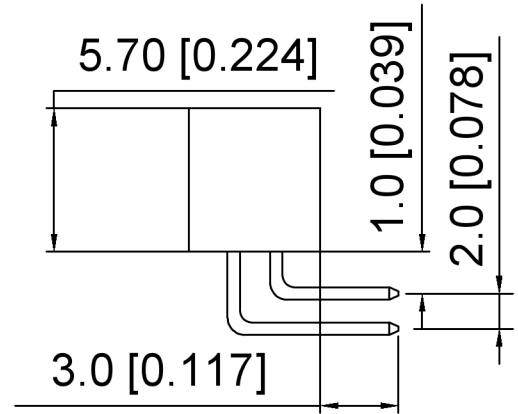
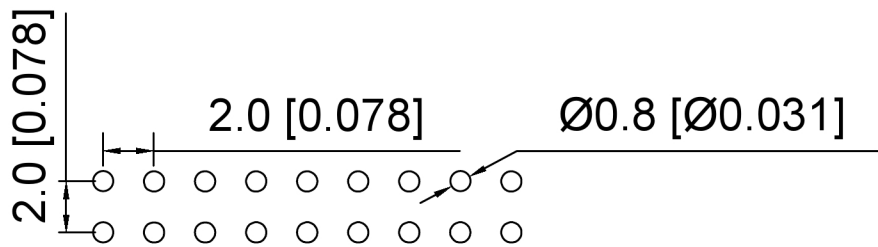
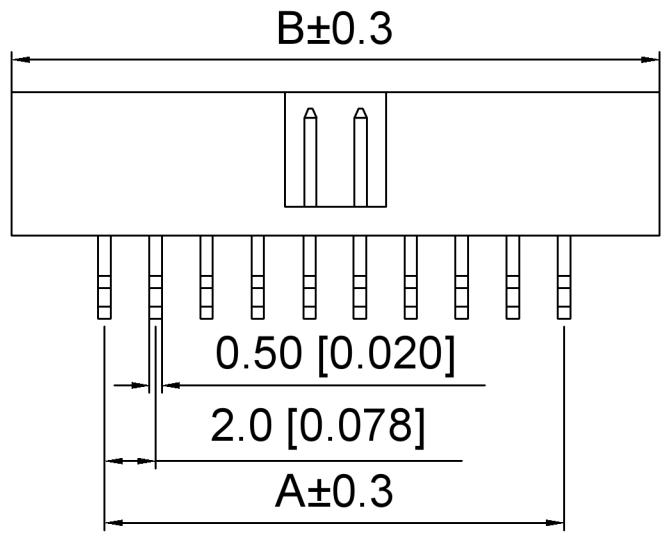
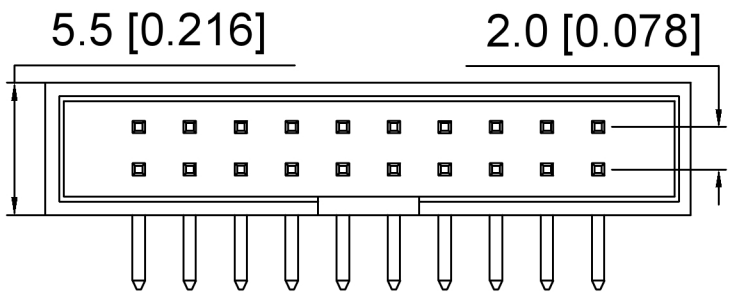

P . C . B LAYOUT

Specifications:
 规格:
 Voltage rating:250V AC/DC
 额定电压: 250V AC/DC
 Current rating:1A AC/DC
 额定电流: 1A AC/DC
 Withstanding voltage:500V AC/minute
 耐受电压: 500V AC/分钟
 Temperature range:-40℃+105℃
 温度范围: -40℃+105℃
 Insulation resistance: 1000MΩ min
 绝缘电阻: 1000MΩ Min
 Contact resistance:20mΩ Max
 接触电阻: 20mΩ Max

- X2001 W R - 2xXX A - 6T V01
 ① ② ③ ④ ⑤ ⑥ ⑦
- 1.Series No
 - 2.Category:W-Wafer
 - 3.Welding Board Angle:R-Stright 90°
 - 4.Row No.Pin No.:2xXX-2x03-2x32P
 - 5.Category:A-No gap
 - 6.Material:6T-Nylon 6T UL94V-0
 - 7.Plating:V01-Gold Flash

Poles	Dimensions		Poles	Dimensions	
	A	B		A	B
2x03	4.00	13.30	2x12	22.00	31.30
2x04	6.00	15.30	2x13	24.00	33.30
2x05	8.00	17.30	2x15	28.00	37.30
2x06	10.00	19.30	2x17	32.00	41.30
2x07	12.00	21.30	2x20	38.00	47.30
2x08	14.00	23.30	2x22	42.00	51.30
2x09	16.00	25.30	2x25	48.00	57.30
2x10	18.00	27.30	2x30	58.00	67.30
2x11	20.00	29.30	2x32	62.00	71.30

X2001WR-2xXXA-6TV01	Nylon 6T	Brass	X2001H / X2001H2
PART NO	Material	Material(Pin)	Suitable XKB IDC

广东星坤科技股份有限公司
 日期
 文件工程章

REVISIONS	DATE	REVISED	APPROVED	DESCRIPTION
Δx				
Δx				
Δx				
MARK				

DSND	SCALE: N/A	MODEL TYPE: 2.0mm Crimp Style Connector
DWN	VIEW:	PART NO.: X2001WR-2xXXA-6TV01
CHKD	UNIT: mm/in	DWG NO.: X-X2001WR-2xXXA-6TV01
APPD	SIZE: A4	WEIGHT SHEET REVISION 1/1 A0
XKB INDUSTRIAL PRECISION CO.,LIMITED		



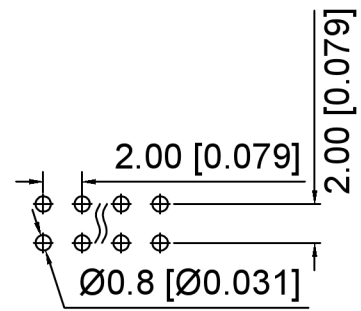
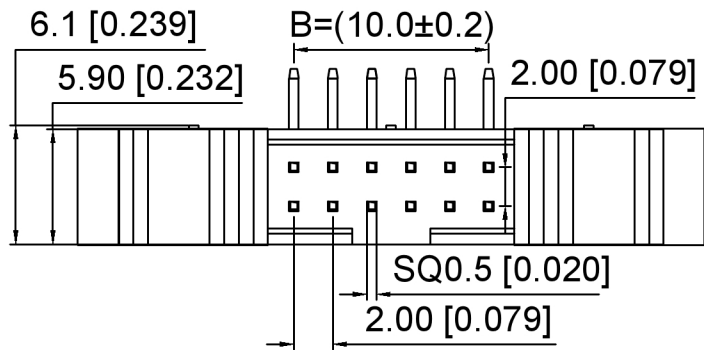

PCB Layout

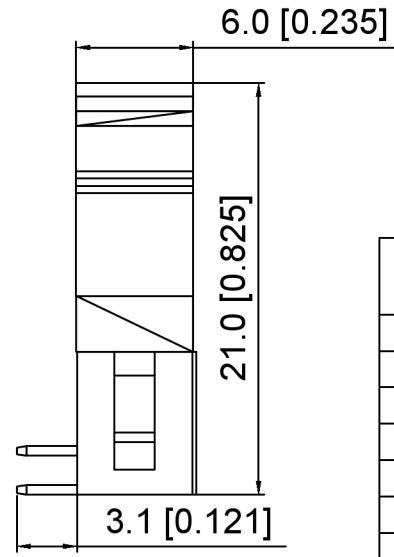
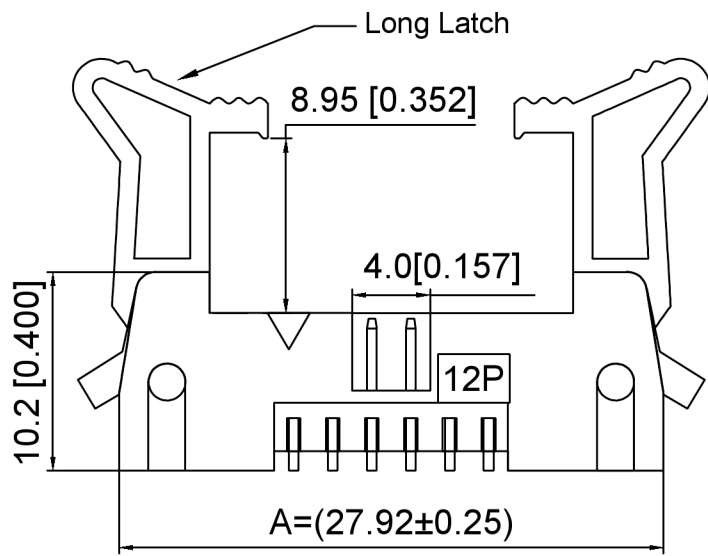

Specifications:
 规格:
 Voltage rating: 250V AC/DC
 额定电压: 250V AC/DC
 Current rating: 1A AC/DC
 额定电流: 1A AC/DC
 Withstanding voltage: 500V AC/minute
 耐受电压: 500V AC/分钟
 Temperature range: -40°C~+105°C
 温度范围: -40°C~+105°C
 Insulation resistance: 1000MΩ min
 绝缘电阻: 1000MΩ Min
 Contact resistance: 20mΩ Max
 接触电阻: 20mΩ Max

X2001 W R - 2xXX C - 6T V01
 ① ② ③ ④ ⑤ ⑥ ⑦

1. Series No
2. Category: W-Wafer
3. Welding Board Angle: R-Stright 90°
4. Row No. Pin No: 2xXX-2x03-2x32P
5. Category: C-long ears
6. Material: 6T-Nylon 6T UL94V-0
7. Plating: V01-Gold Flash

Poles	Dimensions		Poles	Dimensions	
	A	B		A	B
2x03	21.92	4.00	2x13	41.92	24.00
2x04	23.92	6.00	2x15	45.92	28.00
2x05	25.92	8.00	2x17	49.92	32.00
2x06	27.92	10.00	2x20	55.92	38.00
2x07	29.92	12.00	2x22	59.92	42.00
2x08	31.92	14.00	2x25	65.92	48.00
2x10	35.92	18.00	2x30	75.92	58.00
2x12	39.92	22.00	2x32	79.92	62.00

$$A = 2.0 \times \frac{NP}{2} + 15.92 \pm 0.25$$

$$B = 2.0 \times \frac{NP}{2} - 2.0 \pm 0.2$$

X2001WR-2xXXC-6TV01	Nylon 6T	Brass	X2001H2
PART NO	Material	Material(Pin)	Suitable XKB IDC

广东星坤科技股份有限公司

MARK	DESCRIPTION	DATE	REVISED	APPROVED	UNSPECIFIED TOLERANCES
±Δx					ANGULAR ±5°
Δx					L ≤ 4 ±0.2
Δx					4 < L ≤ 16 ±0.3
Δx					16 < L ≤ 63 ±0.4
					L > 63 ±0.5

DSND	SCALE: N/A	MODEL TYPE: 2.0mm Crimp Style Connector
DWN	VIEW:	PART NO.: X2001WR-2xXXC-6TV01
CHKD	UNIT: mm/in	DWG NO.: X-X2001WR-2xXXC-6TV01
APPD	SIZE: A4	WEIGHT

文件工程章

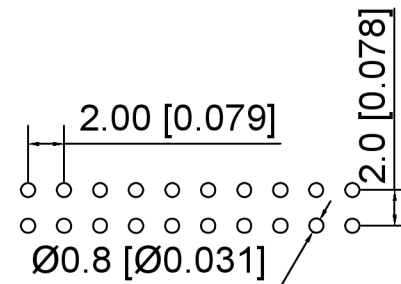
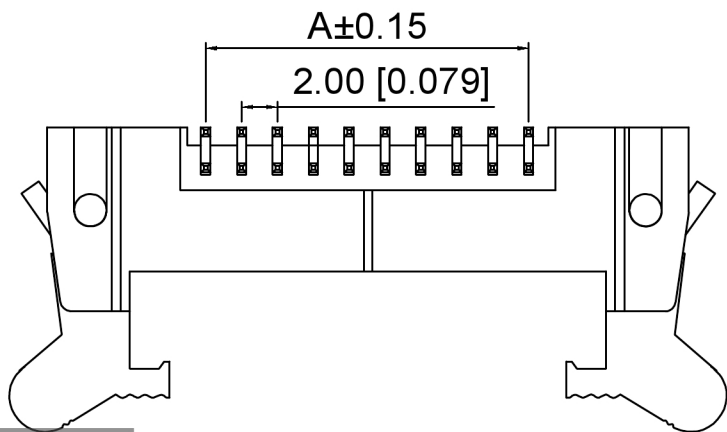
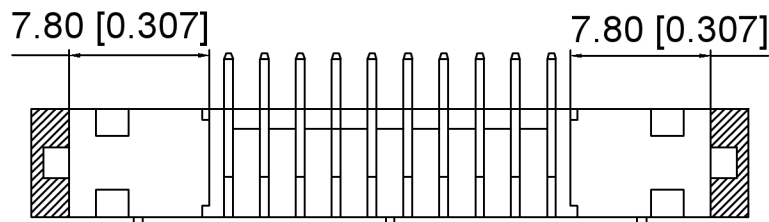
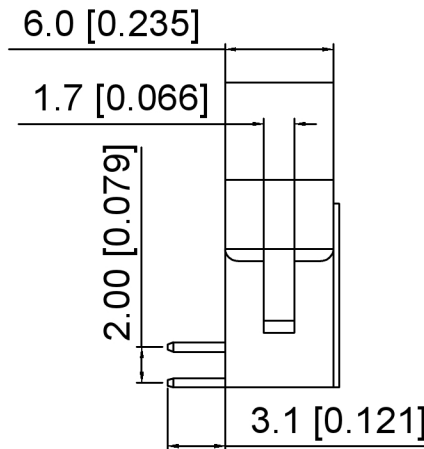
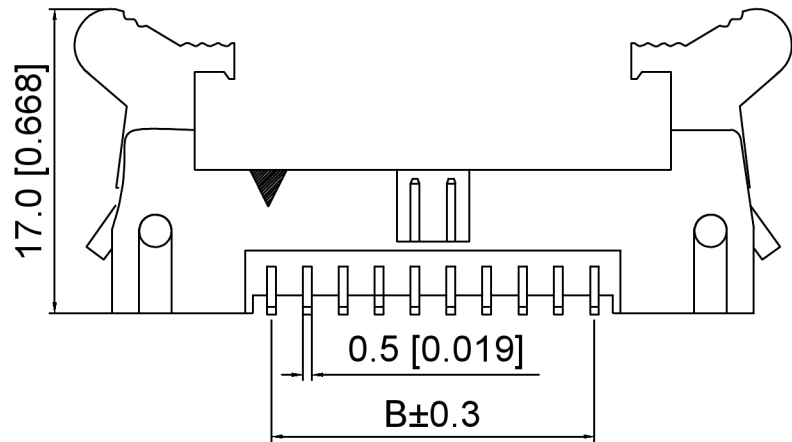

Specifications:

规格:

- Voltage rating: 250V AC/DC
- 额定电压: 250V AC/DC
- Current rating: 1A AC/DC
- 额定电流: 1A AC/DC
- Withstanding voltage: 500V AC/minute
- 耐受电压: 500V AC/分钟
- Temperature range: -40°C~+105°C
- 温度范围: -40°C~+105°C
- Insulation resistance: 1000MΩ min
- 绝缘电阻: 1000MΩ Min
- Contact resistance: 20mΩ Max
- 接触电阻: 20mΩ Max

X2001 W R - 2xXX D - 6T V01
 ① ② ③ ④ ⑤ ⑥ ⑦

1. Series No
2. Category: W-Wafer
3. Welding Board Angle: R-Stright 90°
4. Row No. Pin No.: 2xXX-2x03-2x30P
5. Category: D-Short ears
6. Material: 6T-Nylon 6T UL94V-0
7. Plating: V01-Gold Flash

Poles	Dimensions		Poles	Dimensions	
	A	B		A	B
2x03	4.00	21.60	2x13	24.00	41.60
2x04	6.00	23.60	2x15	28.00	45.60
2x05	8.00	25.60	2x17	32.00	49.60
2x06	10.00	27.60	2x20	38.00	55.60
2x07	12.00	29.60	2x22	42.00	59.60
2x08	14.00	31.60	2x25	48.00	65.60
2x10	18.00	35.60	2x30	58.00	75.60
2x12	22.00	39.60	/		

X2001WR-2xXXD-6TV01	Nylon 6T	Brass	X2001H
PART NO	Material	Material(Pin)	Suitable XKB IDC

DSND	SCALE: N/A	MODEL TYPE: 2.0mm Crimp Style Connector
DWN	VIEW:	PART NO.: X2001WR-2xXXD-6TV01
CHKD	UNIT: mm/in	DWG NO.: X-X2001WR-2xXXD-6TV01
APPD	SIZE: A4	WEIGHT
XKB INDUSTRIAL PRECISION CO., LIMITED		SHEET
		REVISION
		1/1
		A0



广东星坤科技股份有限公司

日期

文件工程章

REVISIONS	DATE	REVISED	APPROVED	UNSPECIFIED TOLERANCES
ANGLAR				±5°
L ≤ 4				±0.2
4 < L ≤ 16				±0.3
16 < L ≤ 63				±0.4
L > 63				±0.5

www.helloxkb.com www.helloxkb.cn www.xk-dg.cn

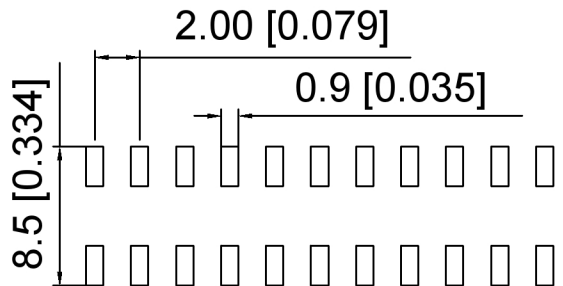
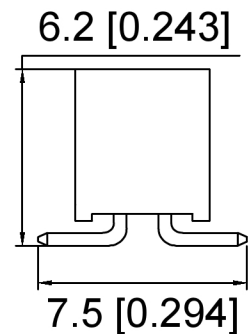
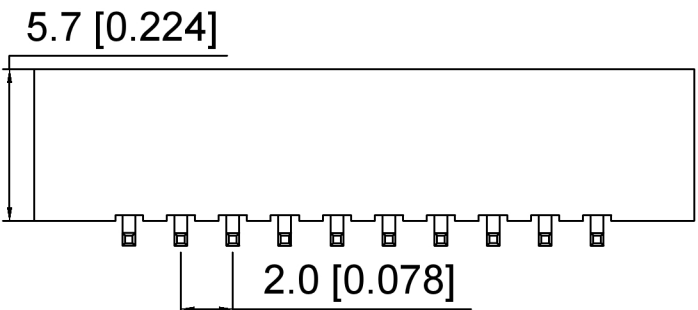
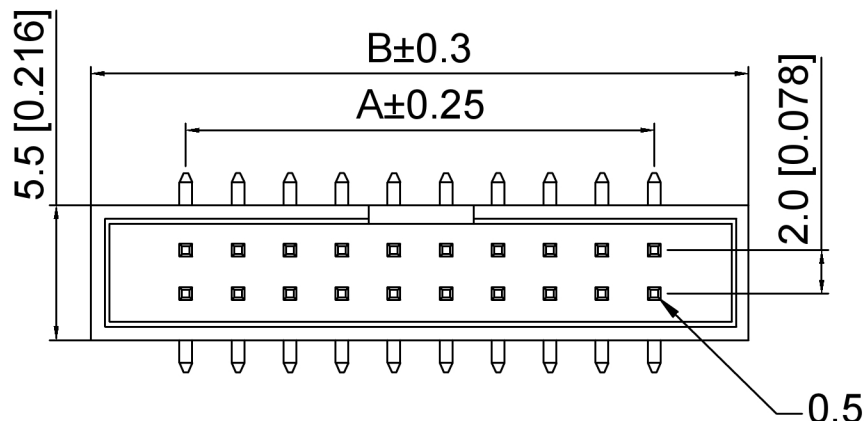

P.C.B LAYOUT

Specifications:
 规格:
 Voltage rating:250V AC/DC
 额定电压: 250V AC/DC
 Current rating:1A AC/DC
 额定电流: 1A AC/DC
 Withstanding voltage:500V AC/minute
 耐受电压: 500V AC/分钟
 Temperature range:-40°C+105°C
 温度范围: -40°C+105°C
 Insulation resistance: 1000MΩ min
 绝缘电阻: 1000MΩ Min
 Contact resistance:20mΩ Max
 接触电阻: 20mΩ Max

X2001 W V S - 2xXX A - 6T V01
 ① ② ③ ④ ⑤ ⑥ ⑦ ⑧

- 1.Series No
- 2.Category:W-Wafer
- 3.Welding Board Angle:V-Stright 180°
- 4.Welding Way : S-SMT
- 5.Row No.Pin No: 2xXX-2x03-2x32P
- 6.Category:A-No gap
- 7.Material:6T-Nylon 6T UL 94V-0
- 8.Plating:V01-Gold Flash

Poles	Dimensions		Poles	Dimensions	
	A	B		A	B
2x03	4.00	13.30	2x12	22.00	31.30
2x04	6.00	15.30	2x13	24.00	33.30
2x05	8.00	17.30	2x15	28.00	37.30
2x06	10.00	19.30	2x17	32.00	41.30
2x07	12.00	21.30	2x20	38.00	47.30
2x08	14.00	23.30	2x22	42.00	51.30
2x09	16.00	25.30	2x25	48.00	57.30
2x10	18.00	27.30	2x30	58.00	67.30
2x11	20.00	29.30	2x32	62.00	71.30

X2001WVS-2xXXA-6TV01	Nylon 6T	Brass	X2001H / X2001H2
PART NO	Material	Material(Pin)	Suitable XKB IDC

广东星坤科技股份有限公司

Δx	日期
Δx	日期
Δx	日期
MARK	DESCRIPTION

文件工程章

REVISIONS	DATE	REVISED	APPROVED	UNSPECIFIED TOLERANCES
ANGLAR				±5°
L ≤ 4				±0.2
4 < L ≤ 16				±0.3
16 < L ≤ 63				±0.4
L > 63				±0.5



DSND	SCALE: N/A	MODEL TYPE: 2.0mm Crimp Style Connector
DWN	VIEW:	PART NO.: X2001WVS-2xXXA-6TV01
CHKD	UNIT: mm/in	DWG NO.: X-X2001WVS-2xXXA-6TV01
APPD	SIZE: A4	WEIGHT

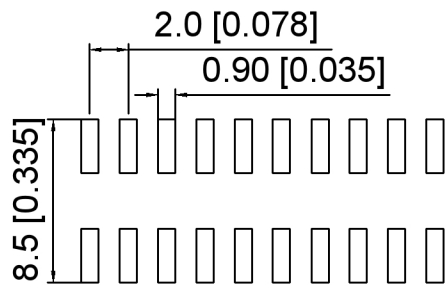
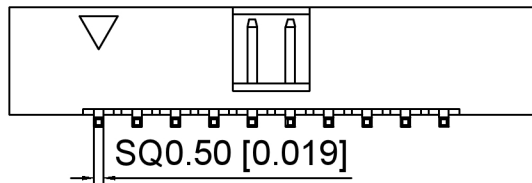
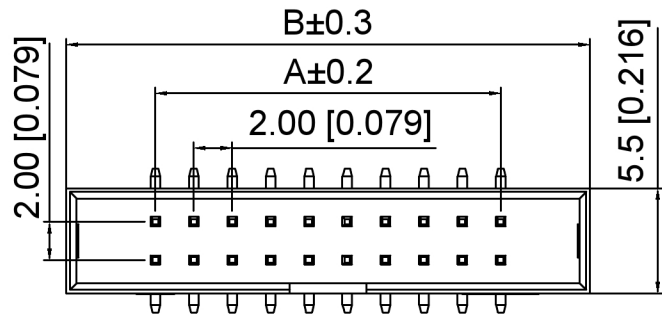

P.C.B LAYOUT

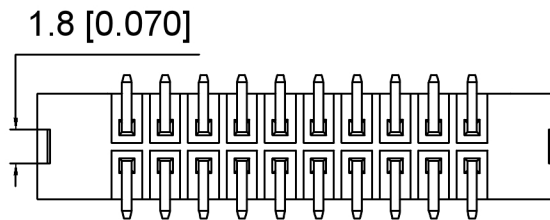
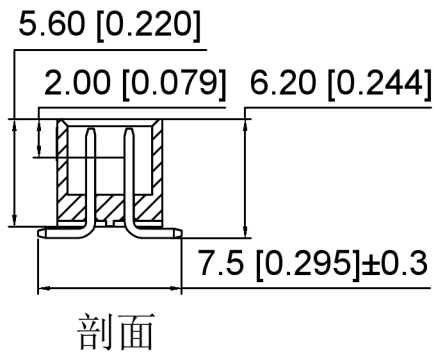

Specifications:

规格:

Voltage rating:250V AC/DC

额定电压: 250V AC/DC

Current rating:1A AC/DC

额定电流: 1A AC/DC

Withstanding voltage:500V AC/minute

耐受电压: 500V AC/分钟

Temperature range:-40℃+105℃

温度范围: -40℃+105℃

Insulation resistance: 1000MΩ min

绝缘电阻: 1000MΩ Min

Contact resistance:20mΩ Max

接触电阻: 20mΩ Max

X2001 W V S - 2xXX B - 6T V01
① ② ③ ④ ⑤ ⑥ ⑦ ⑧

1. Series No

2. Category:W-Wafer

3. Welding Board Angle:V-Stright 180°

4. Welding Way : S-SMT

5. Row No. Pin No: 2xXX-2x03-2x32P

6. Category:B-Have gaps

7. Material:6T-Nylon 6T UL 94V-0

8. Plating:V01-Gold Flash

Poles	Dimensions		Poles	Dimensions	
	A	B		A	B
2x03	4.00	13.30	2x12	22.00	31.30
2x04	6.00	15.30	2x13	24.00	33.30
2x05	8.00	17.30	2x15	28.00	37.30
2x06	10.00	19.30	2x17	32.00	41.30
2x07	12.00	21.30	2x20	38.00	47.30
2x08	14.00	23.30	2x22	42.00	51.30
2x09	16.00	25.30	2x25	48.00	57.30
2x10	18.00	27.30	2x30	58.00	67.30
2x11	20.00	29.30	2x32	62.00	71.30

X2001WVS-2xXXB-6TV01	Nylon 6T	Brass	X2001H3 / X2001HA3
PART NO	Material	Material(Pin)	Suitable XKB IDC

广东星坤科技股份有限公司

MARK	DESCRIPTION	DATE	REVISED	APPROVED	UNSPECIFIED TOLERANCES
ΔX					ANGULAR ±5°
ΔX					L ≤ 4 ±0.2
ΔX					4 < L ≤ 16 ±0.3
ΔX					16 < L ≤ 63 ±0.4
ΔX					L > 63 ±0.5



XKB INDUSTRIAL PRECISION CO., LIMITED

DSND	SCALE: N/A	MODEL TYPE:
DWN	VIEW:	2.0mm Crimp Style Connector
CHKD	UNIT: mm/in	PART NO.: X2001WVS-2xXXB-6TV01
APPD	SIZE: A4	DWG NO.: X-X2001WVS-2xXXB-6TV01
		WEIGHT
		SHEET 1/1
		REVISION A0

文件工程章

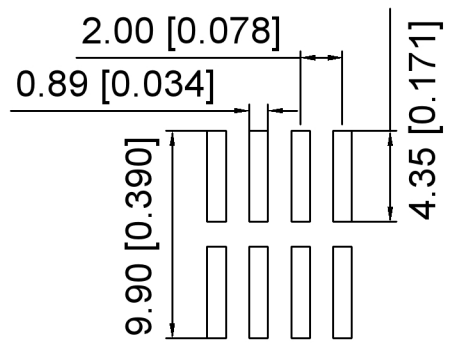
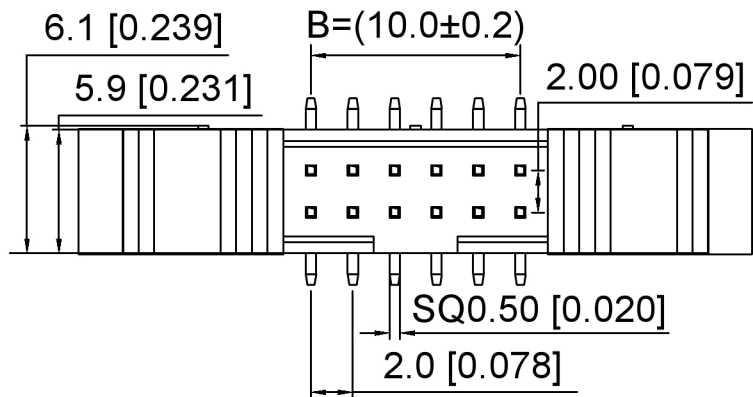

PCB Layout

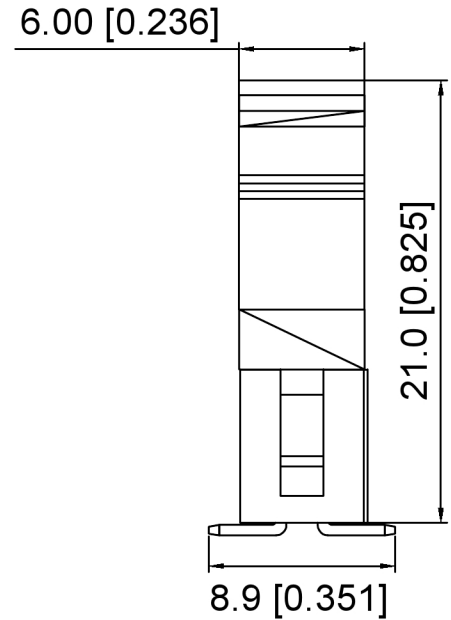
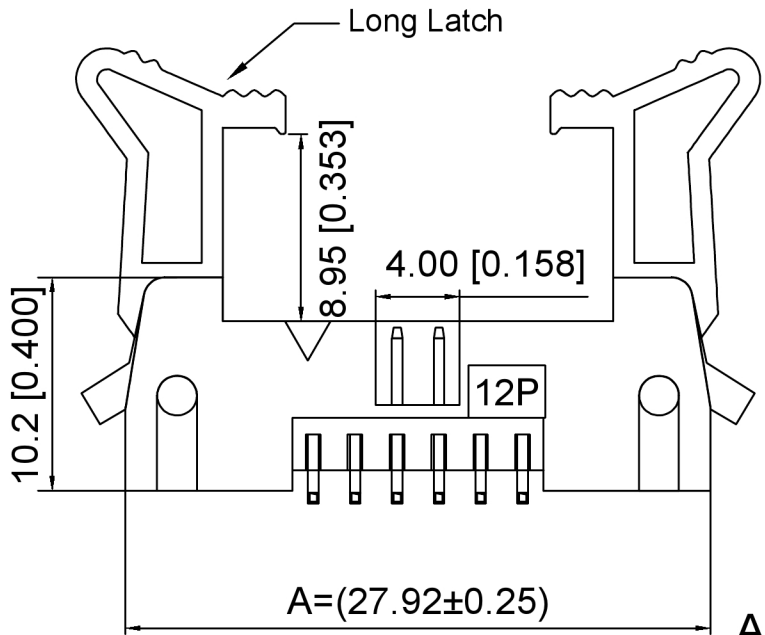

$$A = 2.0 \cdot \frac{NP}{2} + 15.92 \pm 0.25$$

$$B = 2.0 \cdot \frac{NP}{2} - 2.0 \pm 0.2$$

Specifications:
 规格:
 Voltage rating: 250V AC/DC
 额定电压: 250V AC/DC
 Current rating: 1A AC/DC
 额定电流: 1A AC/DC
 Withstanding voltage: 500V AC/minute
 耐受电压: 500V AC/分钟
 Temperature range: -40°C +105°C
 温度范围: -40°C +105°C
 Insulation resistance: 1000MΩ min
 绝缘电阻: 1000MΩ Min
 Contact resistance: 20mΩ Max
 接触电阻: 20mΩ Max

X2001 W V S - 2xXX C - 6T V01
 ① ② ③ ④ ⑤ ⑥ ⑦ ⑧

1. Series No
2. Category: W-Wafer
3. Welding Board Angle: V-Stright 180°
4. Welding Way : S-SMT
5. Row No. Pin No: 2xXX-2x03-2x30P
6. Category: C-long ears
7. Material: 6T-Nylon 6T UL 94V-0
8. Plating: V01-Gold Flash

Poles	Dimensions		Poles	Dimensions	
	A	B		A	B
2x03	21.92	4.00	2x13	41.92	24.00
2x04	23.92	6.00	2x15	45.92	28.00
2x05	25.92	8.00	2x17	49.92	32.00
2x06	27.92	10.00	2x20	55.92	38.00
2x07	29.92	12.00	2x22	59.92	42.00
2x08	31.92	14.00	2x25	65.92	48.00
2x10	35.92	18.00	2x30	75.92	58.00
2x12	39.92	22.00	2x32	79.92	62.00

X2001WVS-2xXXC-6TV01	Nylon 6T	Brass	X2001H2
PART NO	Material	Material(Pin)	Suitable XKB IDC

广东星坤科技股份有限公司

MARK	DESCRIPTION	DATE	REVISED	APPROVED	UNSPECIFIED TOLERANCES
ΔX					ANGULAR ±5°
ΔX					L ≤ 4 ±0.2
ΔX					4 < L ≤ 16 ±0.3
					16 < L ≤ 63 ±0.4
					L > 63 ±0.5



DSND	SCALE: N/A	MODEL TYPE: 2.0mm Crimp Style Connector
DWN	VIEW:	PART NO.: X2001WVS-2xXXC-6TV01
CHKD	UNIT: mm/in	DWG NO.: X-X2001WVS-2xXXC-6TV01
APPD	SIZE: A4	WEIGHT SHEET REVISION
		1/1 AO

文件工程章

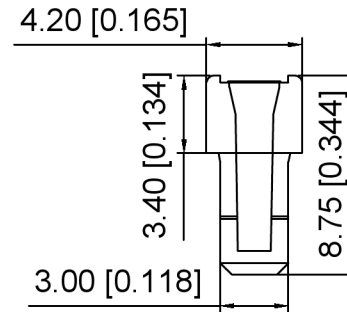
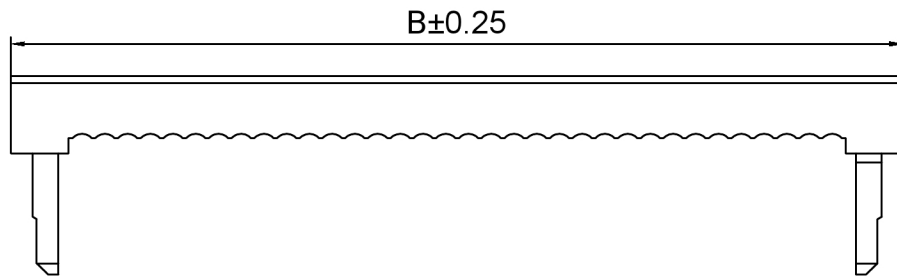

Specifications:
 规格:
 Voltage rating: 250V AC/DC
 额定电压: 250V AC/DC
 Current rating: 1A AC/DC
 额定电流: 1A AC/DC
 Withstanding voltage: 500V AC/minute
 耐受电压: 500V AC/分钟
 Temperature range: -40°C +105°C
 温度范围: -40°C +105°C
 Insulation resistance: 1000MΩ min
 绝缘电阻: 1000MΩ Min
 Contact resistance: 20mΩ Max
 接触电阻: 20mΩ Max

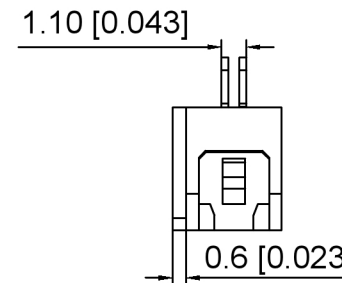
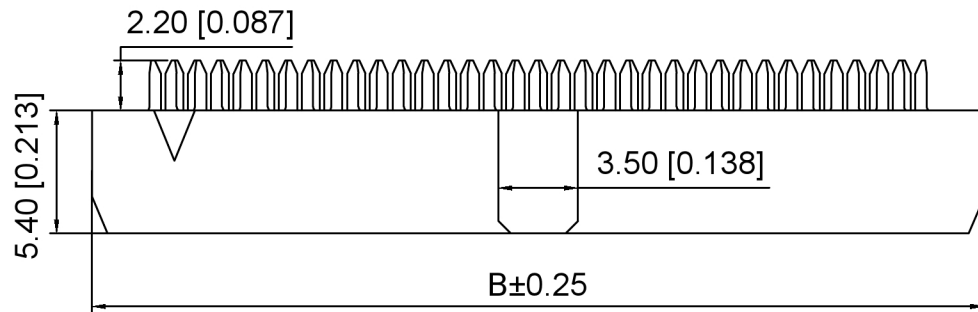

X2001 H - 2xXX -PT V01
 ① ② ③ ④ ⑤

1. Series No
2. Category: H-Two-piece
3. Row No. Pin No: 2xXX-2x03-2x25P
4. Material: PT-PBT Glass Fiber UL94V-0
5. Plating: V01-Gold Flash

Poles	DIM A	DIM B
2x03	4.00	11.20
2x04	6.00	13.20
2x05	8.00	15.20
2x06	10.00	17.20
2x07	12.00	19.20
2x08	14.00	21.20
2x09	16.00	23.20
2x10	18.00	25.20
2x11	20.00	27.20
2x12	22.00	29.20
2x13	24.00	31.20
2x14	26.00	33.20
2x15	28.00	35.20
2x17	32.00	39.20
2x18	34.00	41.20
2x20	38.00	45.20
2x22	42.00	49.20
2x25	48.00	55.20

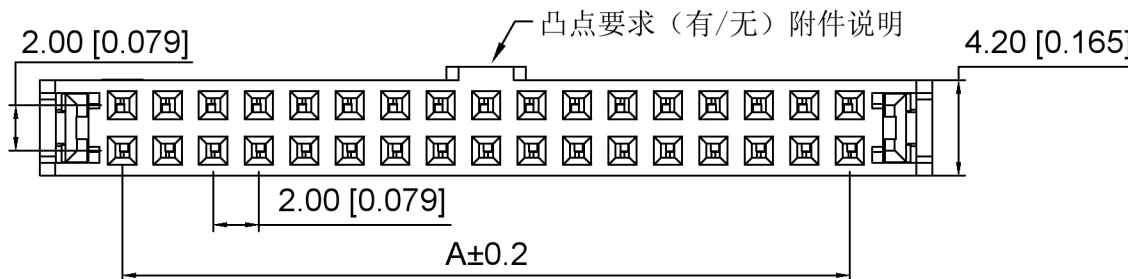

X2001H-2xXX-PTV01	PBT Glass Fiber	Brass	X2001W-A/X2001W-D
PART NO	Material	Material(Pin)	Suitable XKB Wafer

DSND	SCALE: N/A	MODEL TYPE: 2.0mm IDC Connector
DWN	VIEW:	PART NO.: X2001H-2xXX-PTV01
CHKD	UNIT: mm/in	DWG NO.: X-X2001H-2xXX-PTV01
APPD	SIZE: A4	WEIGHT
XKB INDUSTRIAL PRECISION CO., LIMITED		SHEET
		1/1
		REVISION
		A0

ANGULAR	±5°
L ≤ 4	±0.2
4 < L ≤ 16	±0.3
16 < L ≤ 63	±0.4
L > 63	±0.5



XKB INDUSTRIAL PRECISION CO., LIMITED

广东星坤科技股份有限公司

DATE	DATE	DATE	DATE
DATE	DATE	DATE	DATE
DATE	DATE	DATE	DATE
DATE	DATE	DATE	DATE

文件工程章

REVISIONS	DATE	REVISED	APPROVED	UNSPECIFIED TOLERANCES
www.helloxkb.com	www.helloxkb.cn	www.xk-dg.cn		

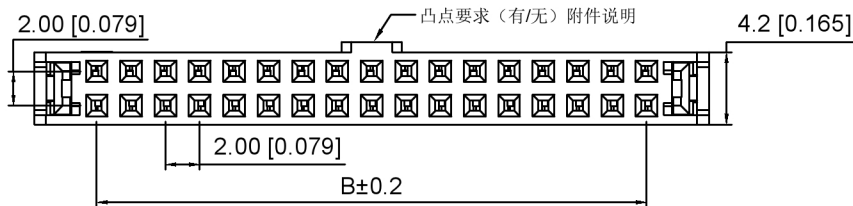
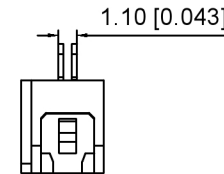
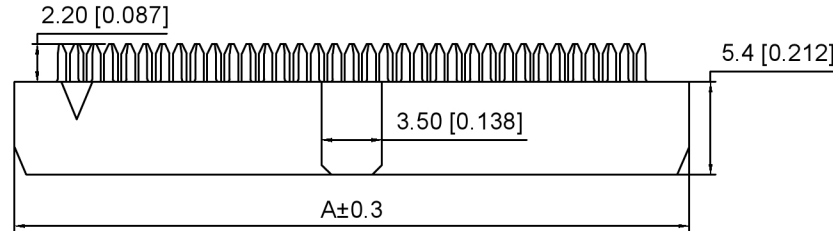
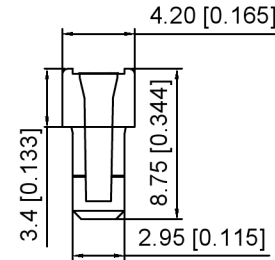
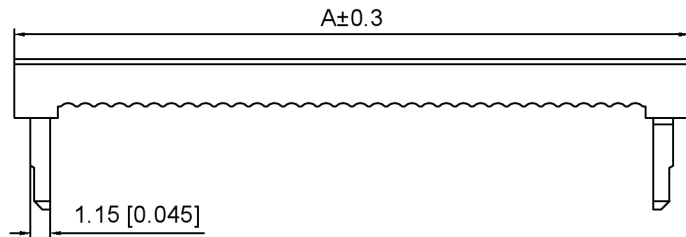
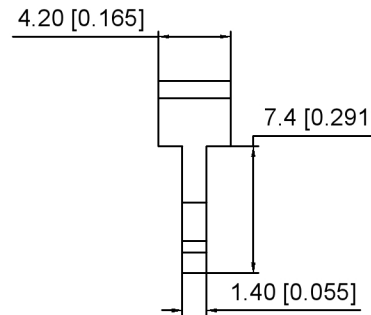
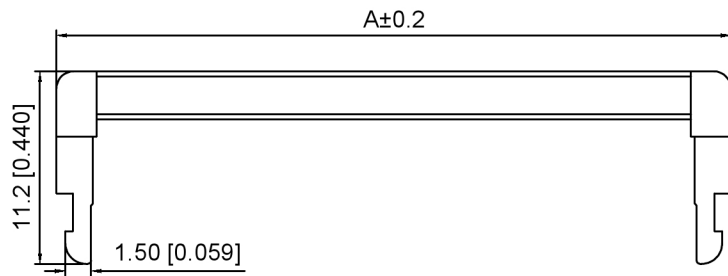

Specifications:

规格:
 Voltage rating:250V AC/DC
 额定电压: 250V AC/DC
 Current rating:1A AC/DC
 额定电流: 1A AC/DC
 Withstanding voltage:500V AC/minute
 耐受电压: 500V AC/分钟
 Temperature range:-40℃-+105℃
 温度范围: -40℃-+105℃
 Insulation resistance: 1000MΩ min
 绝缘电阻: 1000MΩ Min
 Contact resistance:20mΩ Max
 接触电阻: 20mΩ Max

X2001 H2 -2xXX -PT V01
 ① ② ③ ④ ⑤

- 1.Series No
- 2.Category:H2-three-piece
- 3.Row No.Pin No:2xXX-2x03-2x30P
- 4.Material:PT-PBT Glass Fiber UL94V-0
- 5.Plating:V01-Gold Flash

Poles	DIM A	DIM B
2x03	11.20	4.00
2x04	13.20	6.00
2x05	15.20	8.00
2x06	17.20	10.00
2x07	19.20	12.00
2x08	21.20	14.00
2x09	23.20	16.00
2x10	25.20	18.00
2x11	27.20	20.00
2x12	29.20	22.00
2x13	31.20	24.00
2x14	33.20	26.00
2x15	35.20	28.00
2x17	39.20	32.00
2x18	41.20	34.00
2x20	45.20	38.00
2x22	49.20	42.00
2x25	55.20	48.00
2x30	65.20	58.00

X2001H2-2xXX-PTV01	PBT Glass Fiber	Brass	X2001W-A/X2001W-C
PART NO	Material	Material(Pin)	Suitable XKB Wafer

DSND	SCALE: N/A	MODEL TYPE:
DWN	VIEW:	2.0mm IDC Connector
CHKD	UNIT: mm/in	PART NO.:
APPD	SIZE: A4	X2001H2-2xXX-PTV01
		DWG NO.:
		X-X2001H2-2xXX-PTV01
		WEIGHT
		SHEET
		REVISION



XKB INDUSTRIAL PRECISION CO.,LIMITED

广东星坤科技股份有限公司

MARK	DESCRIPTION	DATE	REVISED	APPROVED	UNSPECIFIED TOLERANCES
Δx					ANGULAR ±5°
Δx					L ≤ 4 ±0.2
Δx					4 < L ≤ 16 ±0.3
					16 < L ≤ 63 ±0.4
					L > 63 ±0.5

文件工程章

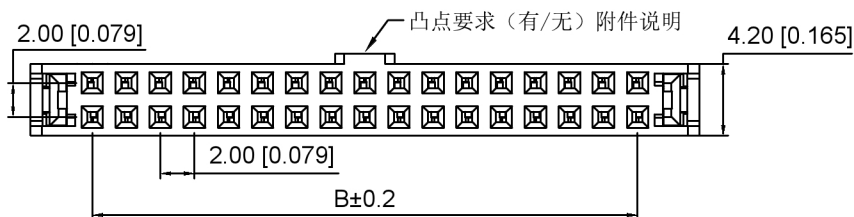
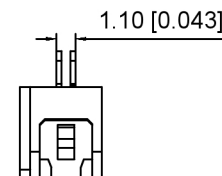
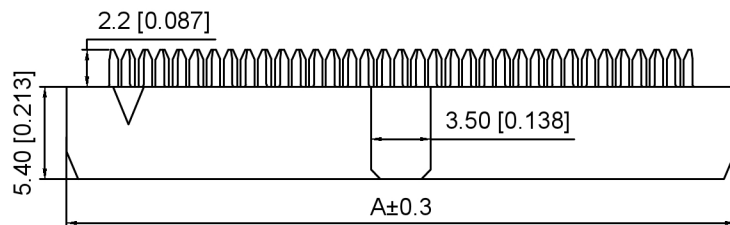
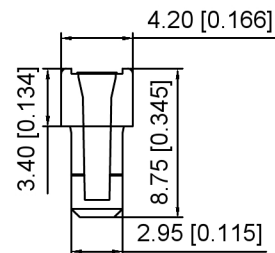
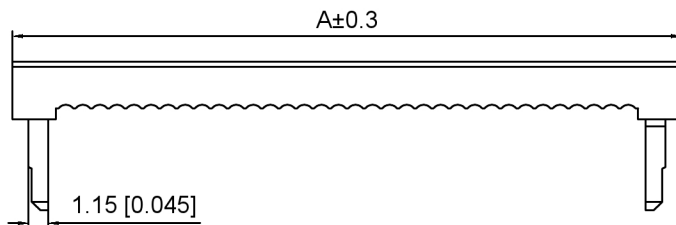
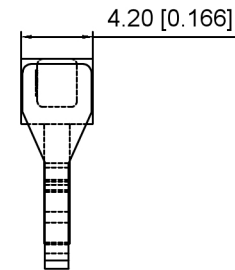
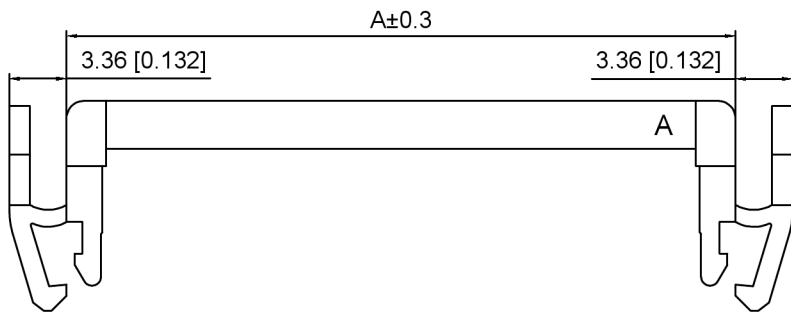

Specifications:
 规格:
 Voltage rating:250V AC/DC
 额定电压: 250V AC/DC
 Current rating:1A AC/DC
 额定电流: 1A AC/DC
 Withstanding voltage:500V AC/minute
 耐受电压: 500V AC/分钟
 Temperature range:-40°C-+105°C
 温度范围: -40°C-+105°C
 Insulation resistance: 1000MΩ min
 绝缘电阻: 1000MΩ Min
 Contact resistance:20mΩ Max
 接触电阻: 20mΩ Max

X2001 H3 -2xXX- PT V01
 ① ② ③ ④ ⑤

- Series No
- Category:H3-Two piece with bow button
- Row No.Pin No:2xXX-2x03P-2x30P
- Material:PT-PBT Glass Fiber UL94V-0
- Plating:V01-Gold Flash

Poles	DIM A	DIM B
2x03	11.20	4.00
2x04	13.20	6.00
2x05	15.20	8.00
2x06	17.20	10.00
2x07	19.20	12.00
2x08	21.20	14.00
2x09	23.20	16.00
2x10	25.20	18.00
2x11	27.20	20.00
2x12	29.20	22.00
2x13	31.20	24.00
2x14	33.20	26.00
2x15	35.20	28.00
2x17	39.20	32.00
2x18	41.20	34.00
2x20	45.20	38.00
2x22	49.20	42.00
2x25	55.20	48.00
2x30	65.20	58.00

X2001H3-2xXX-PTV01	PBT Glass Fiber	Brass	X2001W-B
PART NO	Material	Material(Pin)	Suitable XKB Wafer

DSND	SCALE: N/A	MODEL TYPE: 2.0mm IDC Connector
DWN	VIEW:	PART NO.: X2001H3-2xXX-PTV01
CHKD	UNIT: mm/in	DWG NO.: X-X2001H3-2xXX-PTV01
APPD	SIZE: A4	WEIGHT
UNSPECIFIED TOLERANCES		SHEET
XKB INDUSTRIAL PRECISION CO.,LIMITED		REVISION
		1/1
		A0



广东星坤科技股份有限公司

DATE	DATE	DATE	DATE
DATE	DATE	DATE	DATE
DATE	DATE	DATE	DATE
DATE	DATE	DATE	DATE

文件工程章

REVISIONS	DATE	REVISED	APPROVED	DESCRIPTION

www.helloxkb.com www.helloxkb.cn www.xk-dg.cn

ANGLAR	±5°
L ≤ 4	±0.2
4 < L ≤ 16	±0.3
16 < L ≤ 63	±0.4
L > 63	±0.5

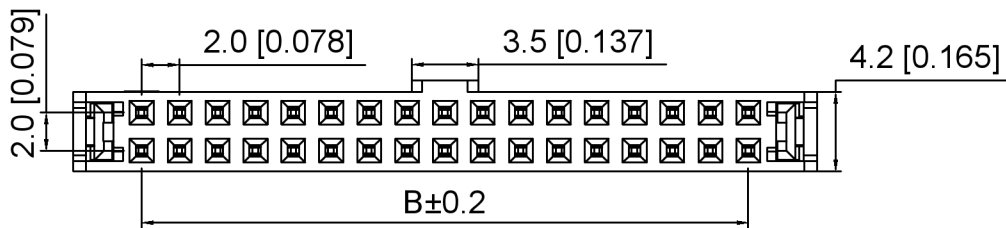
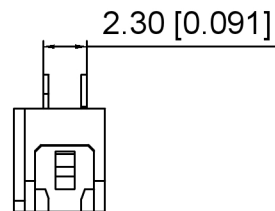
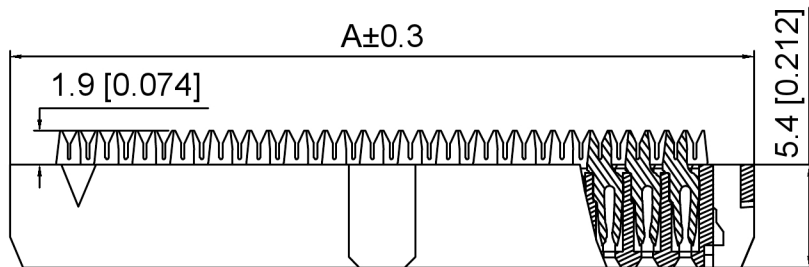
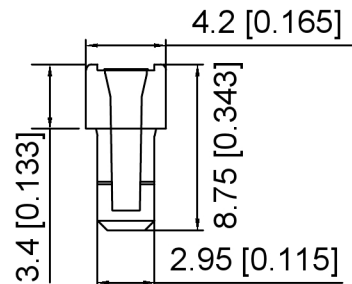
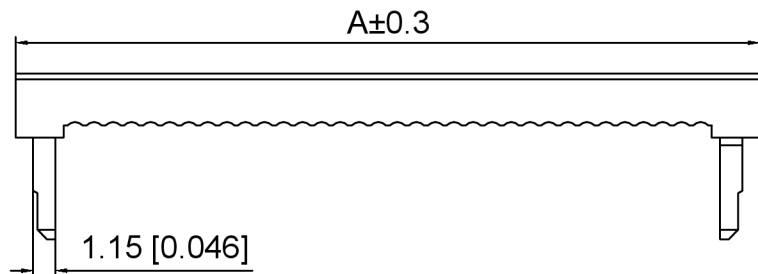

Specifications:

规格:

Voltage rating:250V AC/DC

额定电压: 250V AC/DC

Current rating:1A AC/DC

额定电流: 1A AC/DC

Withstanding voltage:500V AC/minute

耐受电压: 500V AC/分钟

Temperature range:-40℃-+105℃

温度范围: -40℃-+105℃

Insulation resistance: 1000MΩ min

绝缘电阻: 1000MΩ Min

Contact resistance:20mΩ Max

接触电阻: 20mΩ Max

X2001 HA - 2xXX- PT V01

- ① ② ③ ④ ⑤

- 1.Series No
- 2.Category:HA-Two piece double contacts
- 3.Row No.Pin No:2xXX-2x03P-2x30P
- 4.Material:PT-PBT Glass Fiber UL94V-0
- 5.Plating:V01-Gold Flash

Poles	Dimensions		Poles	Dimensions	
	A	B		A	B
2x03	11.20	4.00	2x13	31.20	24.00
2x04	13.20	6.00	2x14	33.20	26.00
2x05	15.20	8.00	2x15	35.20	28.00
2x06	17.20	10.00	2x17	39.20	32.00
2x07	19.20	12.00	2x18	41.20	34.00
2x08	21.20	14.00	2x20	45.20	38.00
2x09	23.20	16.00	2x22	49.20	42.00
2x10	25.20	18.00	2x25	55.20	48.00
2x11	27.20	20.00	2x30	65.20	58.00
2x12	29.20	22.00		/	

X2001HA-2xXX-PTV01	PBT Glass Fiber	Brass	X2001W
PART NO	Material	Material(Pin)	Suitable XKB Wafer

DSND		SCALE: N/A	MODEL TYPE: 2.0mm IDC Connector		
DWN		VIEW:	PART NO.: X2001HA-2xXX-PTV01		
CHKD		UNIT: mm/in	DWG NO.: X-X2001HA-2xXX-PTV01		
APPD		SIZE: A4	WEIGHT	SHEET	REVISION
				1/1	A0



XKB INDUSTRIAL PRECISION CO.,LIMITED

广东星坤科技股份有限公司

ΔX		日期
±ΔX		
ΔX		
MARK		DESCRIPTION

文件工程章

REVISIONS	DATE	REVISED	APPROVED	UNSPECIFIED TOLERANCES
				ANGULAR ±5°
				L ≤ 4 ±0.2
				4 < L ≤ 16 ±0.3
				16 < L ≤ 63 ±0.4
				L > 63 ±0.5

www.helloxkb.com www.helloxkb.cn www.xk-dg.cn

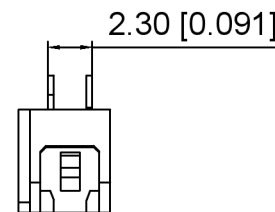
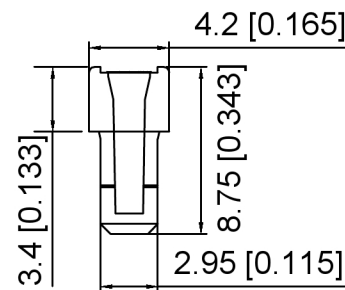
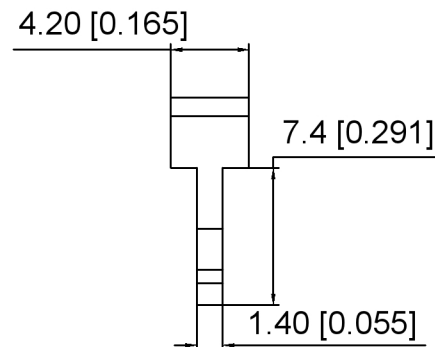
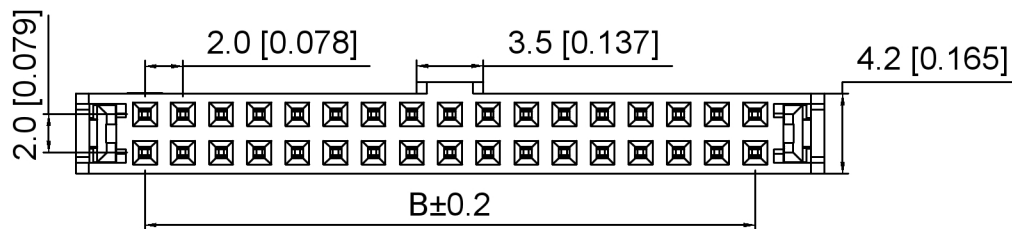
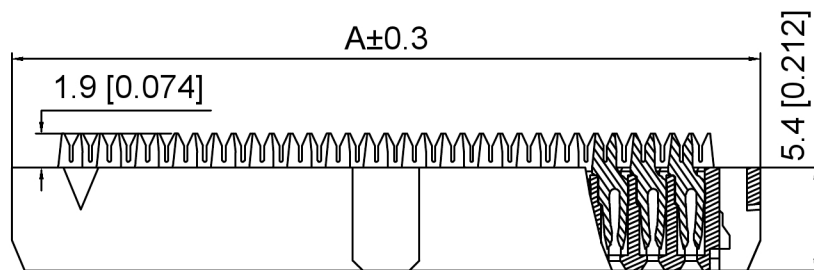
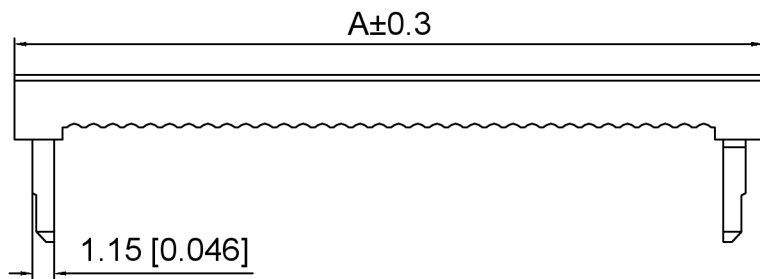
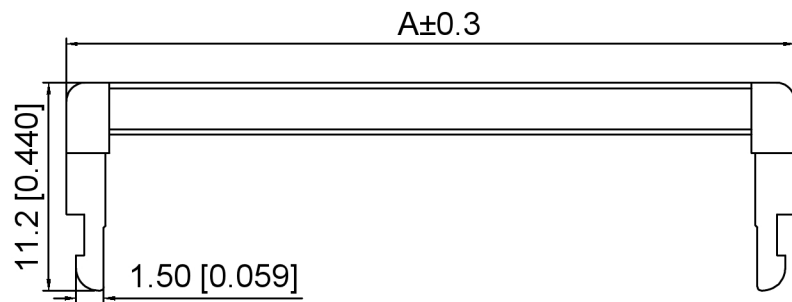

Specifications:
 规格:
 Voltage rating: 250V AC/DC
 额定电压: 250V AC/DC
 Current rating: 1A AC/DC
 额定电流: 1A AC/DC
 Withstanding voltage: 500V AC/minute
 耐受电压: 500V AC/分钟
 Temperature range: -40°C-+105°C
 温度范围: -40°C-+105°C
 Insulation resistance: 1000MΩ min
 绝缘电阻: 1000MΩ Min
 Contact resistance: 20mΩ Max
 接触电阻: 20mΩ Max

X2001 HA2 -2xXX- PT V01
 ① ② ③ ④ ⑤

1. Series No
2. Category: HA2-Three piece double contact
3. Row No. Pin No: 2xXX-2x03P-2x30P
4. Material: PT-PBT Glass Fiber UL94V-0
5. Plating: V01-Gold Flash

Poles	Dimensions		Poles	Dimensions	
	A	B		A	B
2x03	11.20	4.00	2x13	31.20	24.00
2x04	13.20	6.00	2x14	33.20	26.00
2x05	15.20	8.00	2x15	35.20	28.00
2x06	17.20	10.00	2x17	39.20	32.00
2x07	19.20	12.00	2x18	41.20	34.00
2x08	21.20	14.00	2x20	45.20	38.00
2x09	23.20	16.00	2x22	49.20	42.00
2x10	25.20	18.00	2x25	55.20	48.00
2x11	27.20	20.00	2x30	65.20	58.00
2x12	29.20	22.00		/	

X2001HA2-2xXX-PTV01	PBT Glass Fiber	Brass	X2001W
PART NO	Material	Material(Pin)	Suitable XKB Wafer

广东星坤科技股份有限公司
 文件工程章

REVISIONS	DATE	REVISED	APPROVED	UNSPECIFIED TOLERANCES
ANGLAR				±5°
L ≤ 4				±0.2
4 < L ≤ 16				±0.3
16 < L ≤ 63				±0.4
L > 63				±0.5

XKB	DSND	SCALE: N/A	MODEL TYPE:
	DWN	VIEW:	2.0mm IDC Connector
	CHKD	UNIT: mm/in	PART NO.:
	APPD	SIZE: A4	X2001HA2-2xXX-PTV01
			DWG NO.:
			X-X2001HA2-2xXX-PTV01
XKB INDUSTRIAL PRECISION CO., LIMITED		WEIGHT	SHEET
		1/1	REVISION
			A0

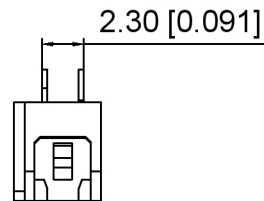
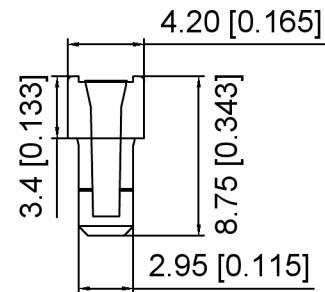
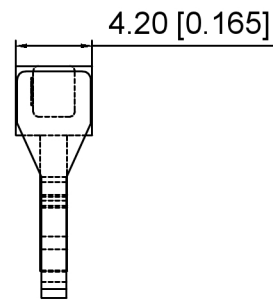
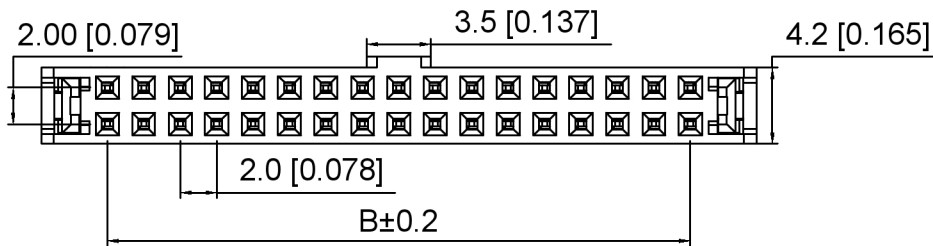
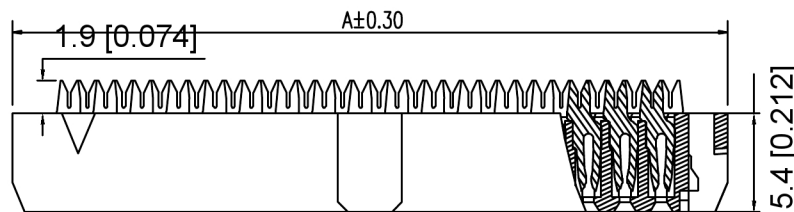
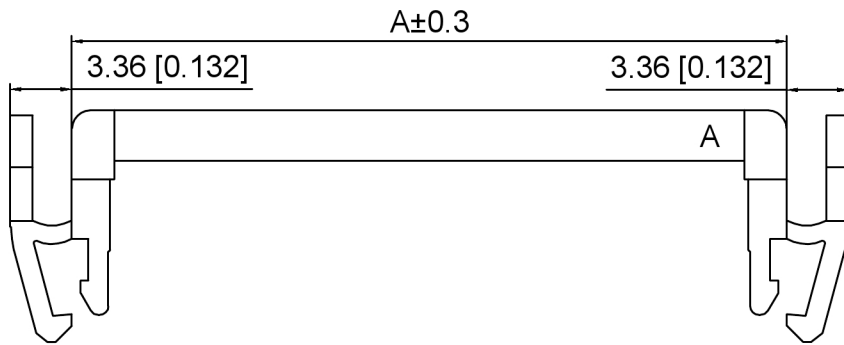

Specifications:

规格:
 Voltage rating: 250V AC/DC
 额定电压: 250V AC/DC
 Current rating: 1A AC/DC
 额定电流: 1A AC/DC
 Withstanding voltage: 500V AC/minute
 耐受电压: 500V AC/分钟
 Temperature range: -40°C +105°C
 温度范围: -40°C +105°C
 Insulation resistance: 1000MΩ min
 绝缘电阻: 1000MΩ Min
 Contact resistance: 20mΩ Max
 接触电阻: 20mΩ Max

X2001 HA3 -2xXX- PT V01

① ② ③ ④ ⑤

1. Series No
2. Category: HA3-Three piece double contact with bow button
3. Row No. Pin No: 2xXX-2x03P-2x30P
4. Material: PT-PBT Glass Fiber UL94V-0
5. Plating: V01-Gold Flash

Poles	Dimensions		Poles	Dimensions	
	A	B		A	B
2x03	11.20	4.00	2x13	31.20	24.00
2x04	13.20	6.00	2x14	33.20	26.00
2x05	15.20	8.00	2x15	35.20	28.00
2x06	17.20	10.00	2x17	39.20	32.00
2x07	19.20	12.00	2x18	41.20	34.00
2x08	21.20	14.00	2x20	45.20	38.00
2x09	23.20	16.00	2x22	49.20	42.00
2x10	25.20	18.00	2x25	55.20	48.00
2x11	27.20	20.00	2x30	65.20	58.00
2x12	29.20	22.00		/	

X2001HA3-2xXX-PTV01	PBT Glass Fiber	Brass	X2001W
PART NO	Material	Material(Pin)	Suitable XKB Wafer

广东星坤科技股份有限公司

MARK	DESCRIPTION	DATE	REVISED	APPROVED	UNSPECIFIED TOLERANCES
Δ*					ANGLAR ±5°
Δ*					L ≤ 4 ±0.2
Δ*					4 < L ≤ 16 ±0.3
					16 < L ≤ 63 ±0.4
					L > 63 ±0.5



DSND		SCALE: N/A	MODEL TYPE: 2.0mm IDC Connector
DWN		VIEW:	PART NO.: X2001HA3-2xXX-PTV01
CHKD		UNIT: mm/in	DWG NO.: X-X2001HA3-2xXX-PTV01
APPD		SIZE: A4	WEIGHT
XKB INDUSTRIAL PRECISION CO., LIMITED			SHEET
			REVISION
			1/1
			A0

文件工程章