

# OPAx392 Precision, Low-Offset-Voltage, Low-Noise, Low-Input-Bias-Current, Rail-to-Rail I/O, e-trim™ Operational Amplifiers

## 1 Features

- Low offset voltage:  $\pm 10\mu\text{V}$  (maximum)
- Low-drift:  $\pm 0.18\mu\text{V}/^\circ\text{C}$
- Low input bias current: 10fA
- Low noise:  $4.4\text{nV}/\sqrt{\text{Hz}}$  at 10kHz
- Low 1/f noise:  $2\mu\text{V}_{\text{PP}}$  (0.1Hz to 10Hz)
- Low supply voltage operation: 1.7V to 5.5V
- Low quiescent current: 1.22mA
- Fast settling:  $0.75\mu\text{s}$  (1V to 0.1%)
- Fast slew rate:  $4.5\text{V}/\mu\text{s}$
- High output current:  $+65\text{mA}/-55\text{mA}$  short circuit
- Gain bandwidth: 13MHz
- Rail-to-rail input and output
- Specified temperature range:  $-40^\circ\text{C}$  to  $+125^\circ\text{C}$
- EMI and RFI filtered inputs

## 2 Applications

- [Multiparameter patient monitor](#)
- [Electrocardiogram \(ECG\)](#)
- [Chemistry and gas analyzer](#)
- [Optical module](#)
- [Analog input module](#)
- [Process analytics \(pH, gas, concentration, force and humidity\)](#)
- [Gas detector](#)
- [Analog security camera](#)
- [Merchant DC/DC](#)
- [Pulse oximeter](#)
- [Inter-DC interconnect \(long-haul, submarine\)](#)
- [Data acquisition \(DAQ\)](#)

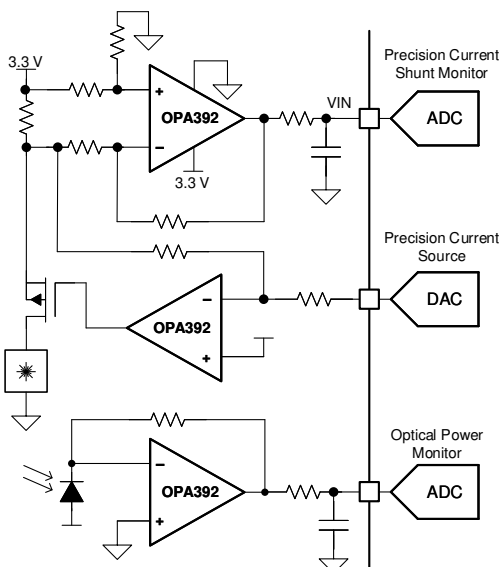

OPAx392 Applications in Optical Modules

## 3 Description

The OPAx392 family of operational amplifiers (OPA392, OPA2392, and OPA4392) features ultra-low offset, offset drift, and input bias current with rail-to-rail input and output operation. In addition to precision dc accuracy, the ac performance is optimized for low noise and fast-settling transient response. These features make the OPAx392 an excellent choice for driving high-precision analog-to-digital converters (ADCs) or buffering the output of high-resolution, digital-to-analog converters (DACs).

The OPAx392 feature TI's e-trim™ operational amplifier technology to achieve ultra-low offset voltage and offset voltage drift without any input chopping or auto-zero techniques. This technique enables ultra-low input bias current for sensor inputs or photodiode current-to-voltage measurements, creating high-performance transimpedance stages for optical modules or medical instrumentation.

### Device Information

PART NUMBER <sup>(1)</sup>	CHANNELS	PACKAGE <sup>(2)</sup>
OPA392	Single	DBV (SOT-23, 5)
	Single	DCK (SC70, 5)
	Single	YBJ (DSBGA, 6)
OPA2392	Dual	D (SOIC, 8)
	Dual	DGK (VSSOP, 8)
	Dual	DSG (WSON, 8)
	Dual	YBJ (DSBGA, 9)
OPA4392	Quad	PW (TSSOP, 14)
	Quad	RTE (WQFN, 16) <sup>(3)</sup>

- (1) See [Section 4](#).
- (2) For more information, see [Section 11](#).
- (3) Preview information (not Production Data).

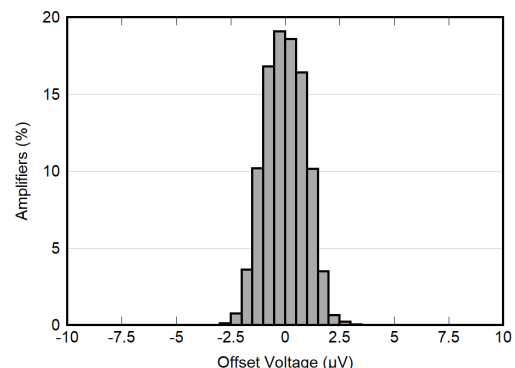

OPAx392 Input Offset Voltage Distribution



## Table of Contents

<b>1 Features</b> .....	1	7.4 Device Functional Modes.....	19
<b>2 Applications</b> .....	1	<b>8 Application and Implementation</b> .....	20
<b>3 Description</b> .....	1	8.1 Application Information.....	20
<b>4 Device Comparison Table</b> .....	2	8.2 Typical Application.....	20
<b>5 Pin Configuration and Functions</b> .....	3	8.3 Power Supply Recommendations.....	23
<b>6 Specifications</b> .....	6	8.4 Layout.....	23
6.1 Absolute Maximum Ratings.....	6	<b>9 Device and Documentation Support</b> .....	24
6.2 ESD Ratings.....	6	9.1 Device Support.....	24
6.3 Recommended Operating Conditions.....	6	9.2 Documentation Support.....	24
6.4 Thermal Information OPA392.....	7	9.3 Receiving Notification of Documentation Updates.....	24
6.5 Thermal Information OPA2392.....	7	9.4 Support Resources.....	24
6.6 Thermal Information OPA4392.....	7	9.5 Trademarks.....	24
6.7 Electrical Characteristics.....	8	9.6 Electrostatic Discharge Caution.....	25
6.8 Typical Characteristics.....	11	9.7 Glossary.....	25
<b>7 Detailed Description</b> .....	18	<b>10 Revision History</b> .....	25
7.1 Overview.....	18	<b>11 Mechanical, Packaging, and Orderable Information</b> .....	25
7.2 Functional Block Diagram.....	18		
7.3 Feature Description.....	19		

## 4 Device Comparison Table

DEVICE	CHANNELS	SHUTDOWN	PACKAGE
OPA392	Single	No	DBV (SOT-23, 5)
		No	DCK (SC70, 5)
		Yes	YBJ (DSBGA, 6)
OPA2392	Dual	No	D (SOIC, 8)
		No	DGK (VSSOP, 8)
		No	DSG (WSON, 8)
		Yes	YBJ (DSBGA, 9)
OPA4392	Quad	No	PW (TSSOP, 14)
		Yes	RTE (WQFN, 16) <sup>(1)</sup>

(1) Preview information (not Production Data).

## 5 Pin Configuration and Functions

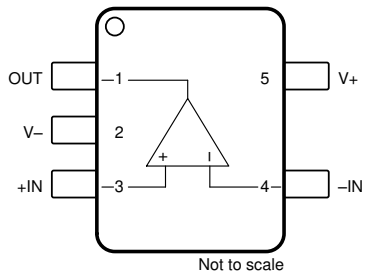

**Figure 5-1. OPA392 DBV Package, 5-Pin SOT-23 (Top View)**

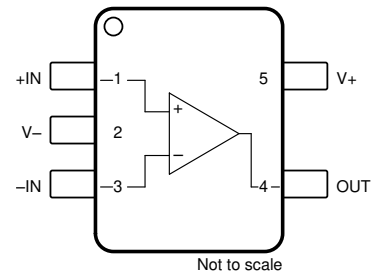

**Figure 5-2. OPA392 DCK Package, 5-Pin SC70 (Top View)**

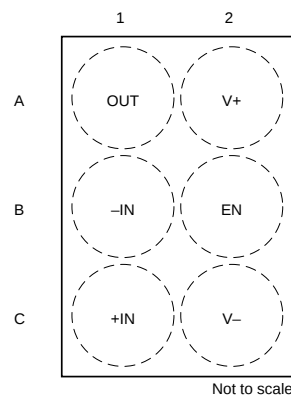

**Figure 5-3. OPA392 YBJ Package, 6-Pin DSBGA (Top View)**

**Table 5-1. Pin Functions: OPA392**

NAME	PIN NO.			TYPE	DESCRIPTION
	DBV (SOT-23)	DCK (SC70)	YBJ (DSBGA)		
EN	—	—	B2	Input	Enable pin. High = amplifier enabled.
-IN	4	3	B1	Input	Inverting input
+IN	3	1	C1	Input	Noninverting input
OUT	1	4	A1	Output	Output
V-	2	2	C2	Power	Negative (lowest) power supply
V+	5	5	A2	Power	Positive (highest) power supply

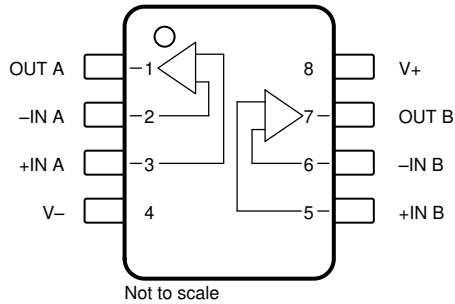

**Figure 5-4. OPA2392 D Package, 8-Pin SOIC and DGK Package, 8-Pin VSSOP (Top View)**

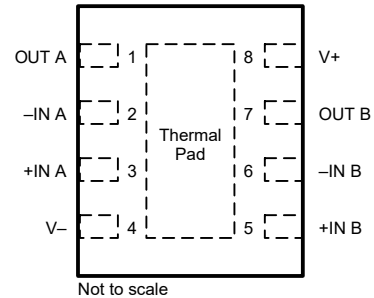

**Figure 5-5. OPA2392 DSG Package, 8-Pin WSON With Exposed Thermal Pad (Top View)**

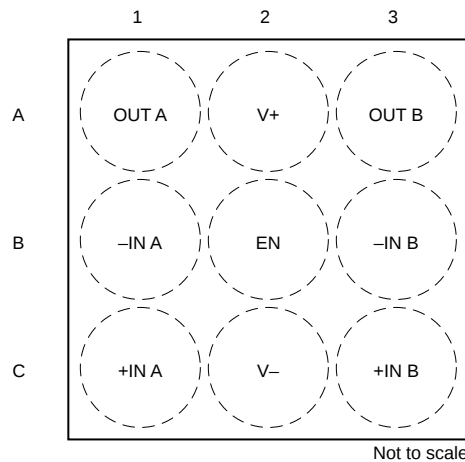

**Figure 5-6. OPA2392 YBJ Package, 9-Pin DSBGA (Top View)**

**Table 5-2. Pin Functions: OPA2392**

NAME	PIN NO.			TYPE	DESCRIPTION
	NO.				
	D (SOIC), DGK (VSSOP)	DSG (WSON)	YBJ (DSBGA)		
EN	—	—	B2	Input	Enable pin. High = both amplifiers enabled.
-IN A	2	2	B1	Input	Inverting input, channel A
+IN A	3	3	C1	Input	Noninverting input, channel A
-IN B	6	6	B3	Input	Inverting input, channel B
+IN B	5	5	C3	Input	Noninverting input, channel B
OUT A	1	1	A1	Output	Output, channel A
OUT B	7	7	A3	Output	Output, channel B
V-	4	4	C2	Power	Negative (lowest) power supply
V+	8	8	A2	Power	Positive (highest) power supply
Thermal Pad	—	Thermal pad	—	—	Connect thermal pad to V-



Figure 5-7. OPA4392 PW Package, 14-Pin TSSOP (Top View)

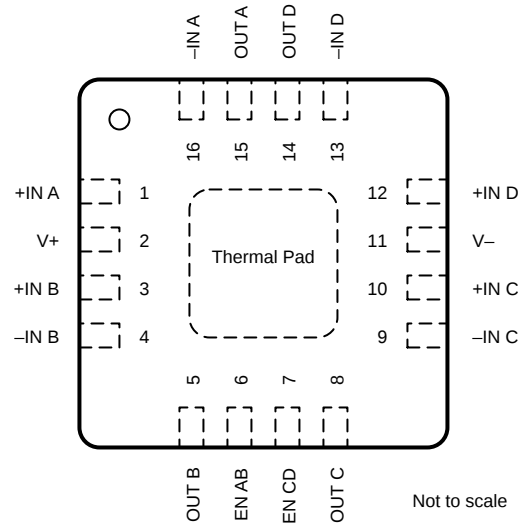

Figure 5-8. OPA4392 RTE Preview Package, 16-Pin WQFN (Top View)

Table 5-3. Pin Functions: OPA4392

NAME	PIN		TYPE	DESCRIPTION
	NO.			
	PW (TSSOP)	RTE (WQFN)		
EN AB	—	6	Input	Enable pin for A and B amplifiers. High = amplifiers A and B are enabled.
EN CD	—	7	Input	Enable pin for C and D amplifiers. High = amplifiers C and D are enabled.
-IN A	2	16	Input	Inverting input, channel A
+IN A	3	1	Input	Noninverting input, channel A
-IN B	6	4	Input	Inverting input, channel B
+IN B	5	3	Input	Noninverting input, channel B
-IN C	9	9	Input	Inverting input, channel C
+IN C	10	10	Input	Noninverting input, channel C
-IN D	13	13	Input	Inverting input, channel D
+IN D	12	12	Input	Noninverting input, channel D
OUT A	1	15	Output	Output, channel A
OUT B	7	5	Output	Output, channel B
OUT C	8	8	Output	Output, channel C
OUT D	14	14	Output	Output, channel D
Thermal Pad	—	Thermal Pad	Power	Connect thermal pad to V-
V-	11	11	Power	Negative (lowest) power supply
V+	4	2	Power	Positive (highest) power supply

## 6 Specifications

### 6.1 Absolute Maximum Ratings

over operating free-air temperature range (unless otherwise noted)<sup>(1)</sup>

			MIN	MAX	UNIT
V <sub>S</sub>	Supply voltage, V <sub>S</sub> = (V+) – (V–)	Single-supply		6	V
		Dual-supply		±3	
	Input voltage, all pins	Common-mode	(V–) – 0.5	(V+) + 0.5	V
		Differential		(V+) – (V–) + 0.2	
	Input current, all pins			±10	mA
	Output short circuit <sup>(2)</sup>		Continuous	Continuous	
T <sub>A</sub>	Operating temperature		–55	150	°C
T <sub>J</sub>	Junction temperature		–55	150	°C
T <sub>stg</sub>	Storage temperature		–65	150	°C

- (1) Operation outside the Absolute Maximum Ratings may cause permanent device damage. Absolute Maximum Ratings do not imply functional operation of the device at these or any other conditions beyond those listed under Recommended Operating Conditions. If used outside the Recommended Operating Conditions but within the Absolute Maximum Ratings, the device may not be fully functional, and this may affect device reliability, functionality, performance, and shorten the device lifetime.

- (2) Short-circuit to ground, one amplifier per package.

### 6.2 ESD Ratings

			VALUE	UNIT
V <sub>(ESD)</sub>	Electrostatic discharge	Human-body model (HBM), per ANSI/ESDA/JEDEC JS-001 <sup>(1)</sup>	±2000	V
		Charged device model (CDM) per ANSI/ESDA/JEDEC JS-002 <sup>(2)</sup>	±500	

- (1) JEDEC document JEP155 states that 500-V HBM allows safe manufacturing with a standard ESD control process.

- (2) JEDEC document JEP157 states that 250-V CDM allows safe manufacturing with a standard ESD control process.

### 6.3 Recommended Operating Conditions

over operating free-air temperature range (unless otherwise noted)

			MIN	NOM	MAX	UNIT
V <sub>S</sub>	Supply voltage	Single-supply	1.7		5.5	V
		Dual-supply	±0.85		±2.75	
T <sub>A</sub>	Specified temperature		–40		125	°C

## 6.4 Thermal Information OPA392

THERMAL METRIC <sup>(1)</sup>		OPA392			UNIT
		DBV (SOT-23)	DCK (SC70)	YBJ (DSBGA)	
		5 PINS	5 PINS	6 PINS	
R <sub>θJA</sub>	Junction-to-ambient thermal resistance	187.1	220.8	135.0	°C/W
R <sub>θJC(top)</sub>	Junction-to-case (top) thermal resistance	107.4	124.4	1.1	°C/W
R <sub>θJB</sub>	Junction-to-board thermal resistance	57.5	72.9	38.8	°C/W
Ψ <sub>JT</sub>	Junction-to-top characterization parameter	33.5	46.1	0.4	°C/W
Ψ <sub>JB</sub>	Junction-to-board characterization parameter	57.1	72.6	38.8	°C/W
R <sub>θJC(bot)</sub>	Junction-to-case (bottom) thermal resistance	N/A	N/A	N/A	°C/W

(1) For more information about traditional and new thermal metrics, see the [Semiconductor and IC Package Thermal Metrics](#) application report.

## 6.5 Thermal Information OPA2392

THERMAL METRIC <sup>(1)</sup>		OPA2392				UNIT
		D (SOIC)	DGK (VSSOP)	DSG (WSON)	YBJ (DSBGA)	
		8 PINS	8 PINS	8 PINS	9 PINS	
R <sub>θJA</sub>	Junction-to-ambient thermal resistance	131.7	165	70.9	110.7	°C/W
R <sub>θJC(top)</sub>	Junction-to-case (top) thermal resistance	71.4	53	88.3	0.7	°C/W
R <sub>θJB</sub>	Junction-to-board thermal resistance	75.2	87	37.5	32.1	°C/W
Ψ <sub>JT</sub>	Junction-to-top characterization parameter	21.8	4.9	2.9	0.3	°C/W
Ψ <sub>JB</sub>	Junction-to-board characterization parameter	74.4	85	37.5	32.1	°C/W
R <sub>θJC(bot)</sub>	Junction-to-case (bottom) thermal resistance	N/A	N/A	12.8	N/A	°C/W

(1) For more information about traditional and new thermal metrics, see the [Semiconductor and IC Package Thermal Metrics](#) application report.

## 6.6 Thermal Information OPA4392

THERMAL METRIC <sup>(1)</sup>		OPA4392	UNIT
		PW (TSSOP)	
		14 PINS	
R <sub>θJA</sub>	Junction-to-ambient thermal resistance	109.6	°C/W
R <sub>θJC(top)</sub>	Junction-to-case (top) thermal resistance	27.4	°C/W
R <sub>θJB</sub>	Junction-to-board thermal resistance	56.1	°C/W
Ψ <sub>JT</sub>	Junction-to-top characterization parameter	1.5	°C/W
Ψ <sub>JB</sub>	Junction-to-board characterization parameter	54.9	°C/W
R <sub>θJC(bot)</sub>	Junction-to-case (bottom) thermal resistance	N/A	°C/W

(1) For more information about traditional and new thermal metrics, see the [Semiconductor and IC Package Thermal Metrics](#) application report.

## 6.7 Electrical Characteristics

at  $T_A = 25^\circ\text{C}$ ,  $V_S = 1.7\text{ V to }5.5\text{ V}$  (single supply) or  $V_S = \pm 0.85\text{ V to } \pm 2.75\text{ V}$  (dual supply),  $R_L = 10\text{ k}\Omega$  connected to  $V_S / 2$ ,  $V_{CM} = V_S / 2$ , and  $V_{OUT} = V_S / 2$  (unless otherwise noted)

PARAMETER		TEST CONDITIONS		MIN	TYP	MAX	UNIT	
<b>OFFSET VOLTAGE</b>								
$V_{OS}$	Input offset voltage	$V_S = 5.0\text{ V}$			$\pm 1$	$\pm 10$	$\mu\text{V}$	
			OPA2392D, OPA4392		$\pm 1$	$\pm 20$		
			OPA392YBJ, OPA2392YBJ		$\pm 1$	$\pm 25$		
		$V_S = 5.0\text{ V}$ , $V_{CM} = (V+) - 200\text{ mV}$	OPA2392YBJ		$\pm 2$	$\pm 30$		
		$V_S = 5.0\text{ V}$ , $T_A = -40^\circ\text{C to } +125^\circ\text{C}^{(1)}$				$\pm 2$		$\pm 85$
		$V_{CM} = V-$ , $T_A = -40^\circ\text{C to } +125^\circ\text{C}^{(1)}$	OPA392, OPA2392D, YBJ, OPA4392			$\pm 125$		
			OPA2392DGK			$\pm 180$		
$dV_{OS}/dT$	Input offset voltage drift	$V_S = 5.0\text{ V}$	$T_A = 0^\circ\text{C to } 85^\circ\text{C}$		$\pm 0.16$		$\mu\text{V}/^\circ\text{C}$	
			$T_A = -40^\circ\text{C to } +125^\circ\text{C}^{(1)}$			$\pm 0.6$		
			$V_{CM} = 5.0\text{ V}$ , $T_A = -40^\circ\text{C to } +125^\circ\text{C}^{(1)}$		$\pm 0.18$	$\pm 0.9$		
PSRR	Power supply rejection ratio	$V_{CM} = V-$				$\pm 30$	$\mu\text{V}/\text{V}$	
			$T_A = -40^\circ\text{C to } +125^\circ\text{C}^{(1)}$					$\pm 80$
<b>INPUT BIAS CURRENT</b>								
$I_B$	Input bias current <sup>(1)</sup>				$\pm 0.01$	$\pm 0.8$	$\text{pA}$	
		$T_A = -40^\circ\text{C to } +85^\circ\text{C}$				$\pm 5$		
		$T_A = -40^\circ\text{C to } +125^\circ\text{C}$				$\pm 30$		
$I_{OS}$	Input offset current <sup>(1)</sup>				$\pm 0.01$	$\pm 0.8$	$\text{pA}$	
		$T_A = -40^\circ\text{C to } +85^\circ\text{C}$				$\pm 5$		
		$T_A = -40^\circ\text{C to } +125^\circ\text{C}$				$\pm 30$		
<b>NOISE</b>								
	Input voltage noise	$f = 0.1\text{ Hz to } 10\text{ Hz}$			2.0		$\mu\text{V}_{PP}$	
			$V_{CM} = (V+) - 0.3$			3.2		
$e_N$	Input voltage noise density	$f = 10\text{ Hz}$			42		$\text{nV}/\sqrt{\text{Hz}}$	
			$V_{CM} = (V+) - 0.3$			80		
		$f = 1\text{ kHz}$				6.5		
			$V_{CM} = (V+) - 0.3$			10.4		
$f = 10\text{ kHz}$				4.4				
	$V_{CM} = (V+) - 0.3$			5.8				
$i_N$	Input current noise density	$f = 1\text{ kHz}$	OPA392DBV		70		$\text{fA}/\sqrt{\text{Hz}}$	
			OPA392YBJ, OPA2392, OPA4392		25			
<b>INPUT VOLTAGE</b>								
$V_{CM}$	Common-mode voltage range			$V-$		$V+$	$V$	
CMRR	Common-mode rejection ratio	$(V-) < V_{CM} < (V+) - 1.5\text{ V}$		75	120		dB	
			$T_A = -40^\circ\text{C to } +125^\circ\text{C}$		113			
		$(V-) < V_{CM} < (V+)$ , $T_A = -40^\circ\text{C to } +125^\circ\text{C}^{(1)}$		66	97			
			$V_S = 5.5\text{ V}$	88	111			
<b>INPUT CAPACITANCE</b>								
$Z_{ID}$	Differential				$10^{13} \parallel 2.8$		$\Omega \parallel \text{pF}$	
$Z_{ICM}$	Common-mode				$10^{13} \parallel 3.5$		$\Omega \parallel \text{pF}$	

## 6.7 Electrical Characteristics (continued)

at  $T_A = 25^\circ\text{C}$ ,  $V_S = 1.7\text{ V}$  to  $5.5\text{ V}$  (single supply) or  $V_S = \pm 0.85\text{ V}$  to  $\pm 2.75\text{ V}$  (dual supply),  $R_L = 10\text{ k}\Omega$  connected to  $V_S / 2$ ,  $V_{CM} = V_S / 2$ , and  $V_{OUT} = V_S / 2$  (unless otherwise noted)

PARAMETER		TEST CONDITIONS		MIN	TYP	MAX	UNIT
<b>OPEN-LOOP GAIN</b>							
$A_{OL}$	Open-loop voltage gain	$V_S = 5.5\text{ V}$	$(V^-) + 50\text{ mV} < V_{OUT} < (V^+) - 50\text{ mV}$	115	132		dB
			$(V^-) + 100\text{ mV} < V_O < (V^+) - 100\text{ mV}$ , $R_L = 2\text{ k}\Omega$	110	128		
			$(V^-) + 100\text{ mV} < V_{OUT} < (V^+) - 100\text{ mV}$ , $R_L = 2\text{ k}\Omega$ , $T_A = -40^\circ\text{C}$ to $+125^\circ\text{C}^{(1)}$	100			
		$V_S = 1.7\text{ V}$	$(V^-) + 50\text{ mV} < V_{OUT} < (V^+) - 50\text{ mV}$ , $V_{CM} = (V^+) - 1.15\text{ V}$	106	124		
			$(V^-) + 100\text{ mV} < V_{OUT} < (V^+) - 100\text{ mV}$ , $R_L = 2\text{ k}\Omega$ , $V_{CM} = (V^+) - 1.15\text{ V}$	106	124		
			$(V^-) + 100\text{ mV} < V_{OUT} < (V^+) - 100\text{ mV}$ , $R_L = 2\text{ k}\Omega$ , $V_{CM} = (V^+) - 1.15\text{ V}$ , $T_A = -40^\circ\text{C}$ to $+125^\circ\text{C}^{(1)}$	100			
<b>FREQUENCY RESPONSE</b>							
GBW	Gain-bandwidth product	$A_V = 1000\text{ V/V}$			13		MHz
SR	Slew rate	4-V step, gain = +1	falling		4.5		V/ $\mu\text{s}$
			rising		3.5		
	Phase margin	$C_L = 100\text{ pF}$	OPA392DBV, DCK, OPA2392DSG		45		°
			OPA392YBJ, OPA2392D, DGK, YBJ, OPA4392		35		
$t_s$	Settling time	To 0.1%, 2-V step, gain = +1			0.75		$\mu\text{s}$
		To 0.01%, 2-V step, gain = +1			1		
	Overload recovery time	$V_{IN} \times \text{gain} > V_S$			0.45		$\mu\text{s}$
THD+N	Total harmonic distortion + noise	$V_{OUT} = 1\text{ V}_{RMS}$ , gain = +1, $f = 1\text{ kHz}$ , $V_{CM} = (V^-) + 1.5\text{ V}$			-112		dB
					0.00025		%
<b>OUTPUT</b>							
	Voltage output swing from both rails	$V_S = 1.7\text{ V}$			20		mV
			$R_L = 2\text{ k}\Omega$		30		
		$V_S = 5.5\text{ V}$			20		
			$R_L = 2\text{ k}\Omega$		35		
$I_{SC}$	Short-circuit current	Sinking, $V_S = 5.5\text{ V}$			-55		mA
		Sourcing, $V_S = 5.5\text{ V}$			65		
$R_O$	Open-loop output impedance	$f = 1\text{ MHz}$			120		$\Omega$
<b>POWER SUPPLY</b>							
$I_Q$	Quiescent current per amplifier	$I_O = 0\text{ mA}$			1.22	1.4	mA
				$T_A = -40^\circ\text{C}$ to $+125^\circ\text{C}^{(1)}$		1.5	

## 6.7 Electrical Characteristics (continued)

at  $T_A = 25^\circ\text{C}$ ,  $V_S = 1.7\text{ V}$  to  $5.5\text{ V}$  (single supply) or  $V_S = \pm 0.85\text{ V}$  to  $\pm 2.75\text{ V}$  (dual supply),  $R_L = 10\text{ k}\Omega$  connected to  $V_S / 2$ ,  $V_{CM} = V_S / 2$ , and  $V_{OUT} = V_S / 2$  (unless otherwise noted)

PARAMETER		TEST CONDITIONS	MIN	TYP	MAX	UNIT
<b>SHUTDOWN (OPA392YBJ, OPA2392YBJ and OPA4392RTE only)</b>						
$I_{QSD}$	Quiescent current per amplifier	All amplifiers disabled, EN = V–		6		$\mu\text{A}$
$V_{IH}$	High-level input voltage	Amplifier enabled	(V+) – 0.5			V
$V_{IL}$	Low-level input voltage	Amplifier disabled			(V–) + 0.5	V
$t_{ON}$	Amplifier enable time	G = 1, $V_{OUT} = 0.9 \times V_S/2$ , two amplifiers enabled		9.5		$\mu\text{s}$
$t_{OFF}$	Amplifier disable time	G = 1, $V_{OUT} = 0.1 \times V_S/2$ , two amplifiers disabled		7.8		$\mu\text{s}$
	EN pin input leakage current	$V_{IH} = V+$		0.02		$\mu\text{A}$
		$V_{IL} = V-$		1		

(1) Specification established from device population bench system measurements across multiple lots.

## 6.8 Typical Characteristics

at  $T_A = 25^\circ\text{C}$ ,  $V_S = 5.5\text{ V}$ ,  $V_{CM} = V_S / 2$ ,  $R_{LOAD} = 10\text{ k}\Omega$  connected to  $V_S / 2$ , and  $C_L = 100\text{ pF}$  (unless otherwise noted)

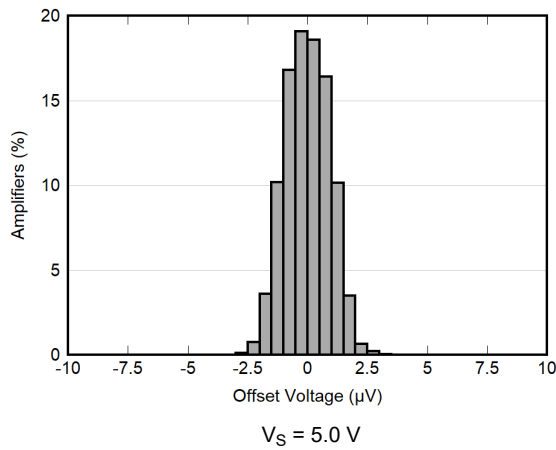

**Figure 6-1. Offset Voltage Distribution**

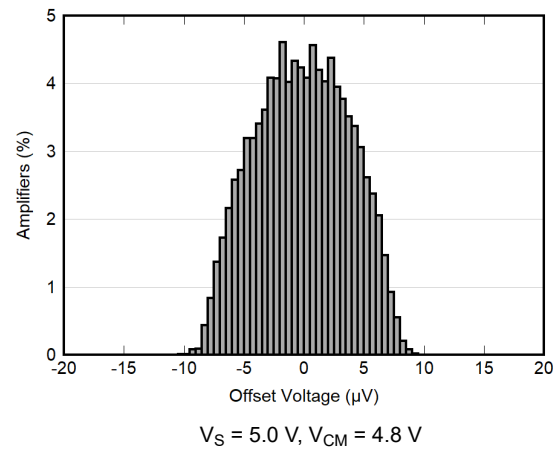

**Figure 6-2. Offset Voltage Distribution**

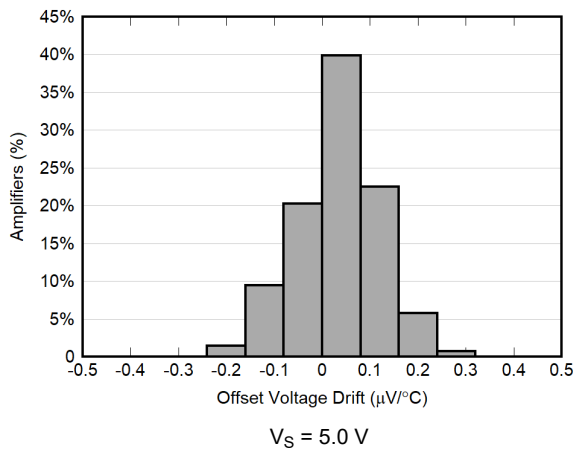

**Figure 6-3. Offset Voltage Distribution**

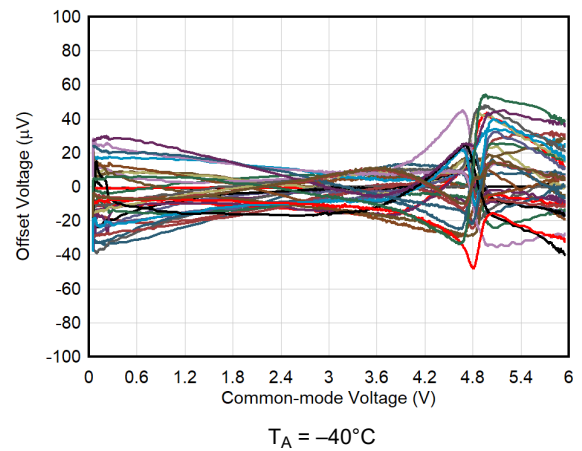

**Figure 6-4. Offset Voltage vs Common-Mode Voltage**

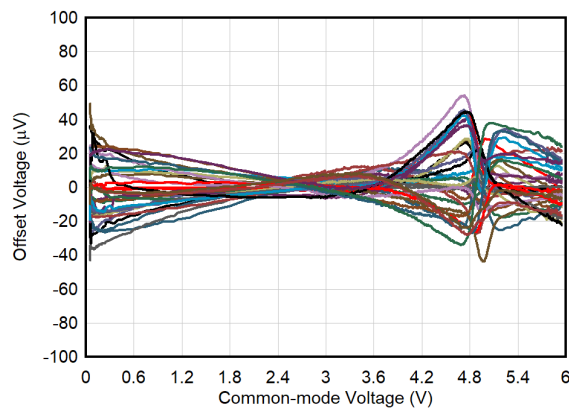

**Figure 6-5. Offset Voltage vs Common-Mode Voltage**

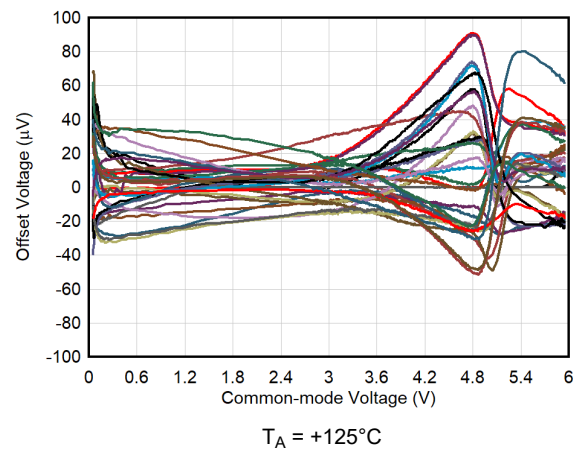

**Figure 6-6. Offset Voltage vs Common-Mode Voltage**

### 6.8 Typical Characteristics (continued)

at  $T_A = 25^\circ\text{C}$ ,  $V_S = 5.5\text{ V}$ ,  $V_{CM} = V_S / 2$ ,  $R_{LOAD} = 10\text{ k}\Omega$  connected to  $V_S / 2$ , and  $C_L = 100\text{ pF}$  (unless otherwise noted)

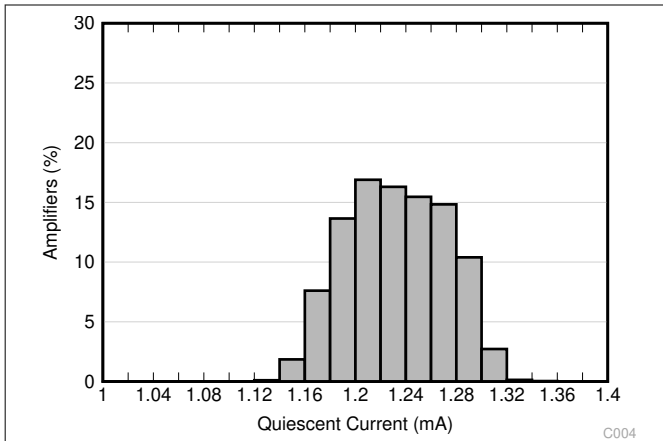

Figure 6-7. Quiescent Current Distribution

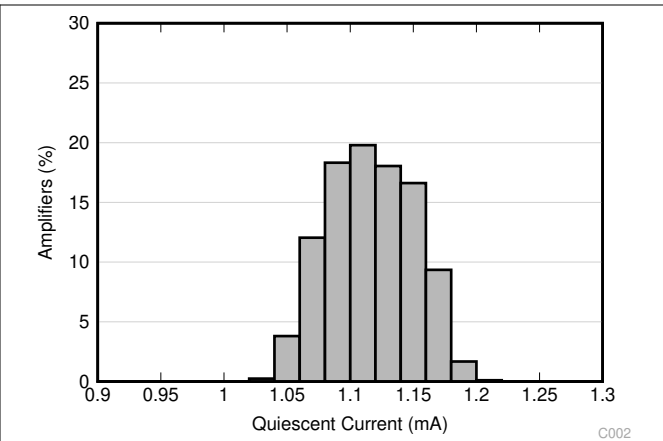

Figure 6-8. Quiescent Current Distribution

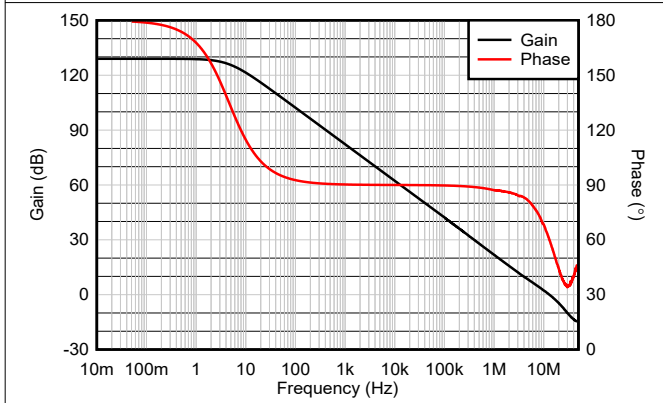

Figure 6-9. Open-Loop Gain and Phase vs Frequency

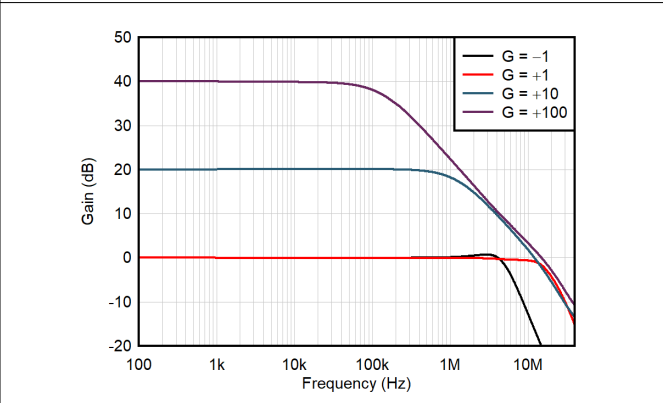

Figure 6-10. Closed-Loop Gain vs Frequency

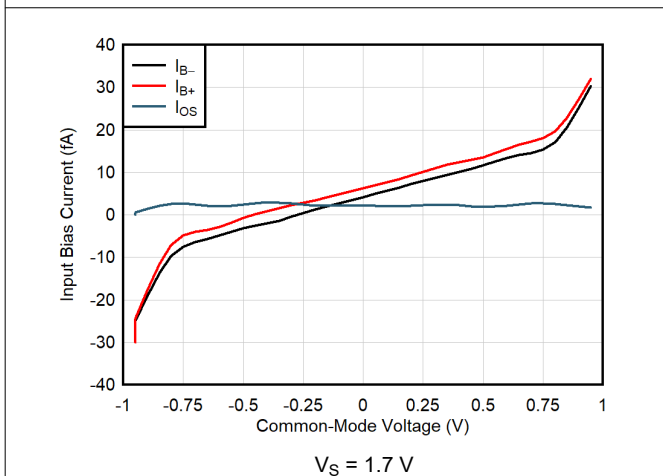

Figure 6-11. Input Bias Current vs Common-Mode Voltage

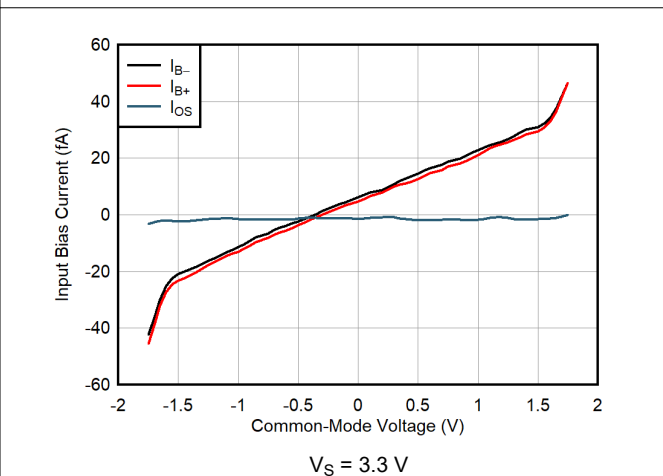
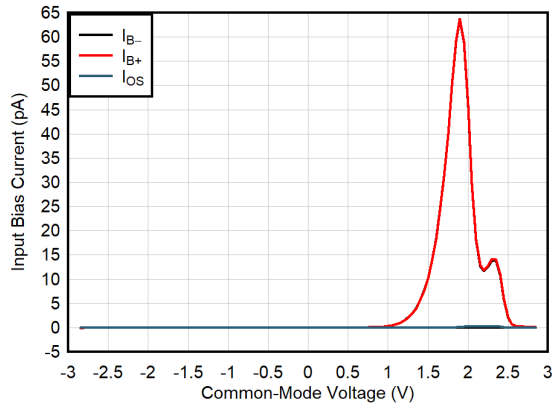

Figure 6-12. Input Bias Current vs Common-Mode Voltage

### 6.8 Typical Characteristics (continued)

at  $T_A = 25^\circ\text{C}$ ,  $V_S = 5.5\text{ V}$ ,  $V_{CM} = V_S / 2$ ,  $R_{LOAD} = 10\text{ k}\Omega$  connected to  $V_S / 2$ , and  $C_L = 100\text{ pF}$  (unless otherwise noted)



**Figure 6-13. Input Bias Current vs Common-Mode Voltage**

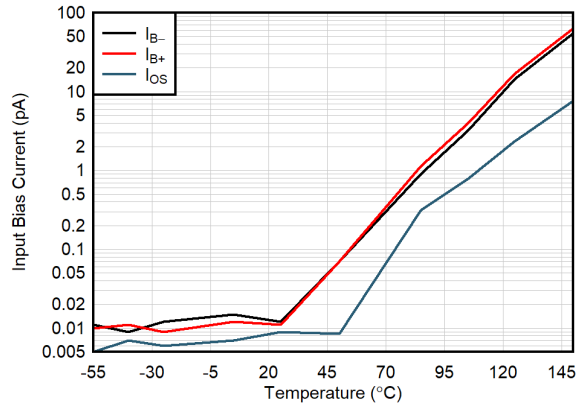

**Figure 6-14. Input Bias Current vs Temperature**

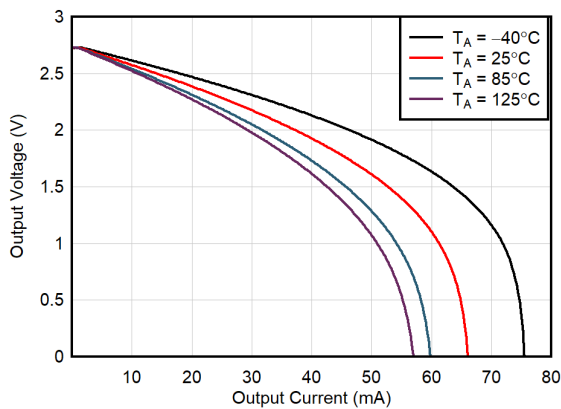

**Figure 6-15. Output Voltage Swing vs Output Current (Sourcing)**

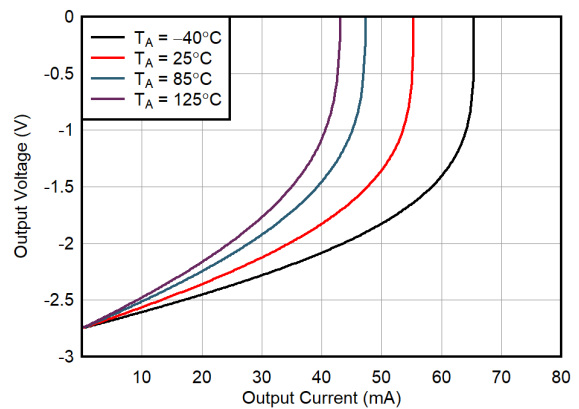

**Figure 6-16. Output Voltage Swing vs Output Current (Sinking)**

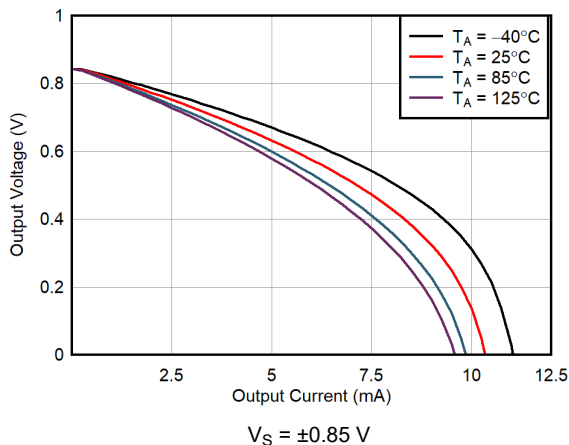

**Figure 6-17. Output Voltage Swing vs Output Current (Sourcing)**

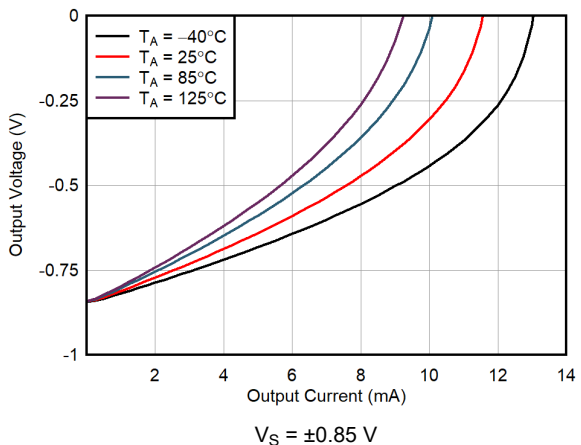

**Figure 6-18. Output Voltage Swing vs Output Current (Sinking)**

## 6.8 Typical Characteristics (continued)

at  $T_A = 25^\circ\text{C}$ ,  $V_S = 5.5\text{ V}$ ,  $V_{CM} = V_S / 2$ ,  $R_{LOAD} = 10\text{ k}\Omega$  connected to  $V_S / 2$ , and  $C_L = 100\text{ pF}$  (unless otherwise noted)

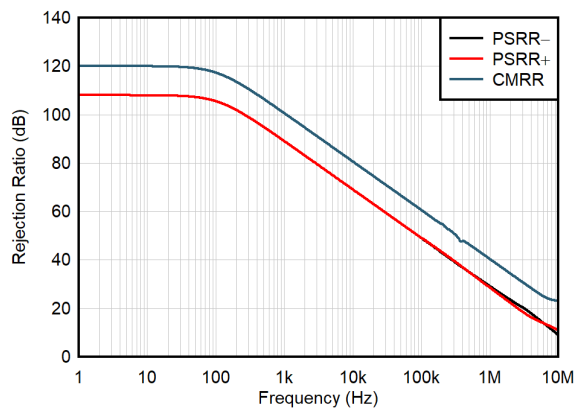

Figure 6-19. CMRR and PSRR vs Frequency

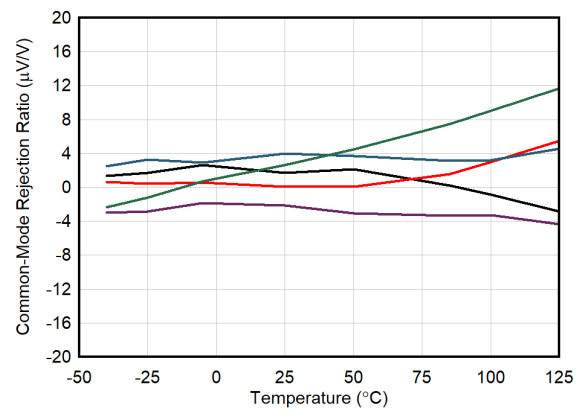

Figure 6-20. CMRR vs Temperature

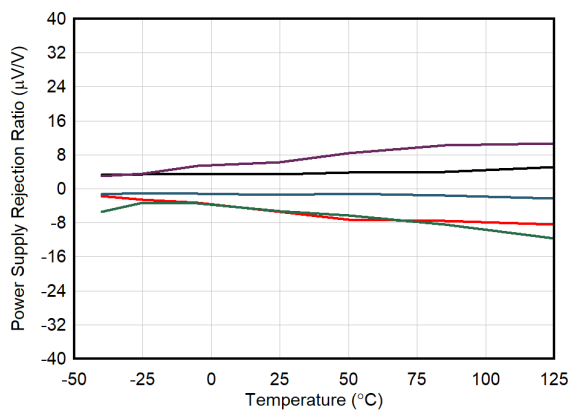

Figure 6-21. PSRR vs Temperature

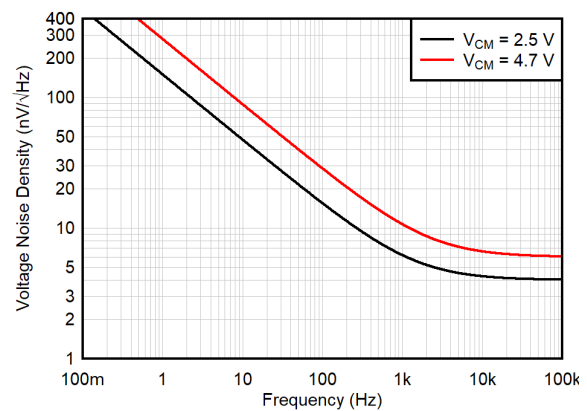

Figure 6-22. Voltage Noise vs Frequency

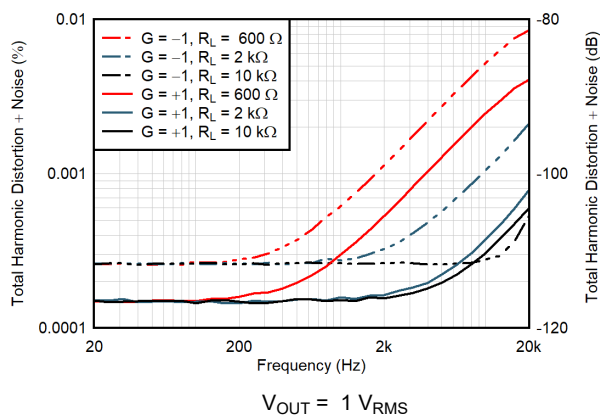

Figure 6-23. THD+N Ratio vs Frequency

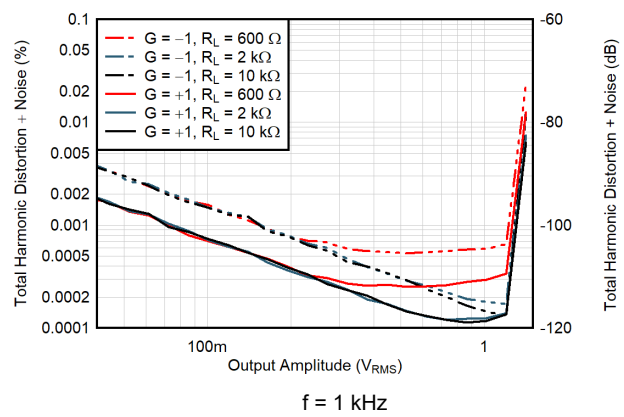
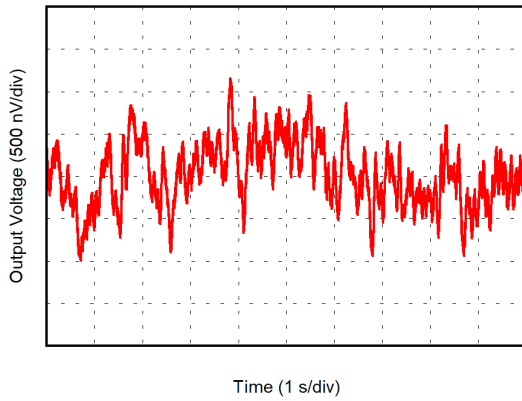

Figure 6-24. THD+N vs Output Amplitude

## 6.8 Typical Characteristics (continued)

at  $T_A = 25^\circ\text{C}$ ,  $V_S = 5.5\text{ V}$ ,  $V_{CM} = V_S / 2$ ,  $R_{LOAD} = 10\text{ k}\Omega$  connected to  $V_S / 2$ , and  $C_L = 100\text{ pF}$  (unless otherwise noted)



**Figure 6-25. 0.1-Hz to 10-Hz Noise**

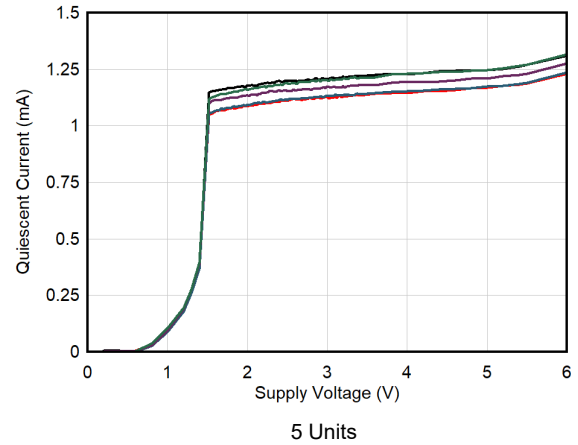

**Figure 6-26. Quiescent Current vs Supply Voltage**

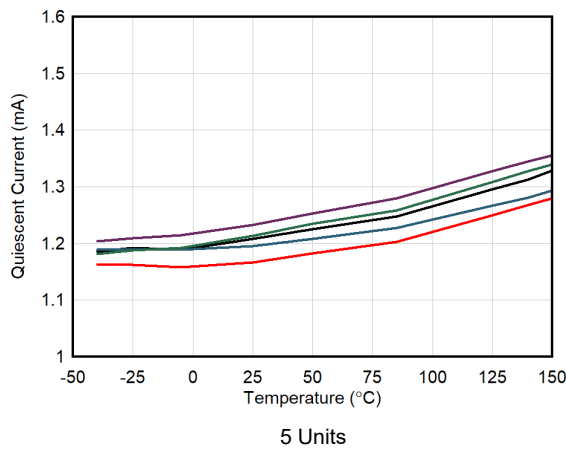

**Figure 6-27. Quiescent Current vs Temperature**

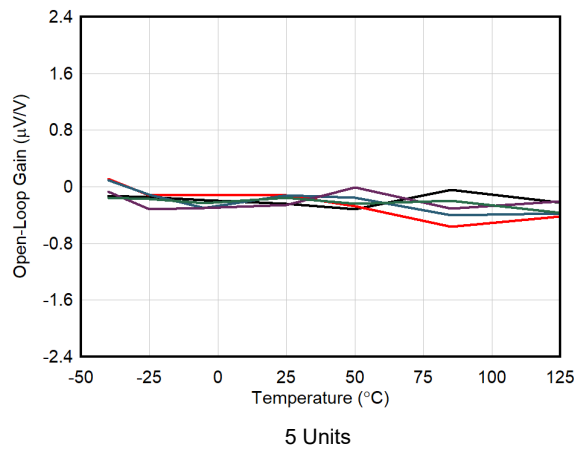

**Figure 6-28. Open-Loop Gain vs Temperature**

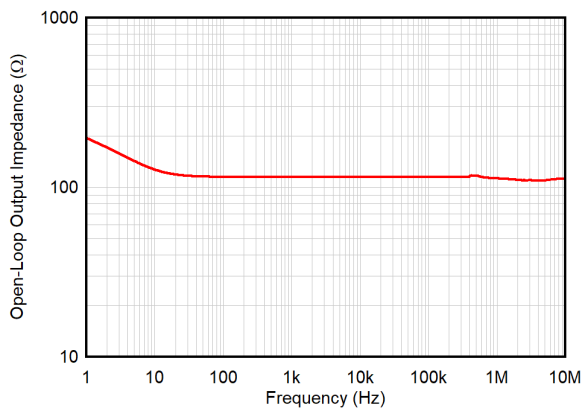

**Figure 6-29. Open-Loop Output Impedance vs Frequency**

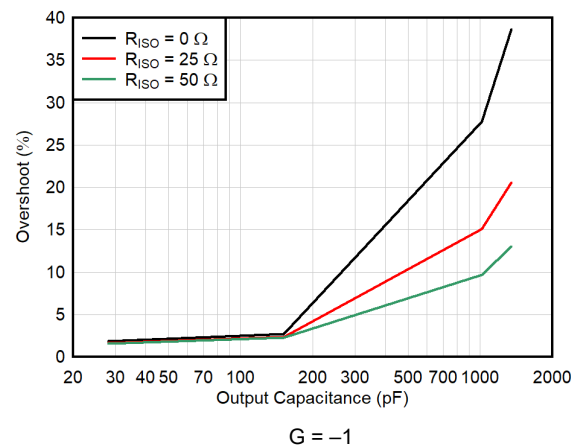

**Figure 6-30. Small-Signal Overshoot vs Capacitive Load (10-mV Step)**

## 6.8 Typical Characteristics (continued)

at  $T_A = 25^\circ\text{C}$ ,  $V_S = 5.5\text{ V}$ ,  $V_{CM} = V_S / 2$ ,  $R_{LOAD} = 10\text{ k}\Omega$  connected to  $V_S / 2$ , and  $C_L = 100\text{ pF}$  (unless otherwise noted)

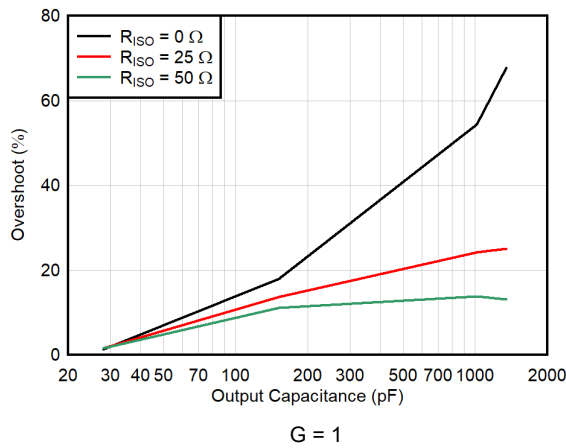

**Figure 6-31. Small-Signal Overshoot vs Capacitive Load (10-mV Step)**

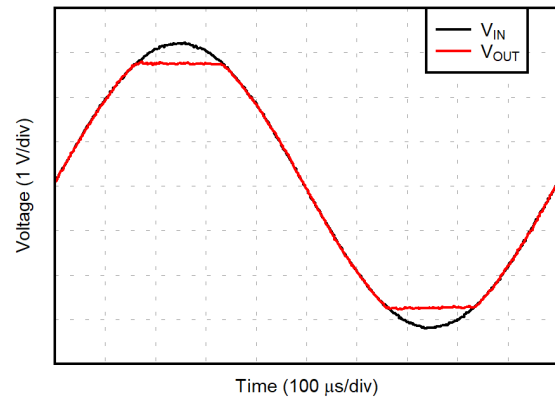

**Figure 6-32. No Phase Reversal**

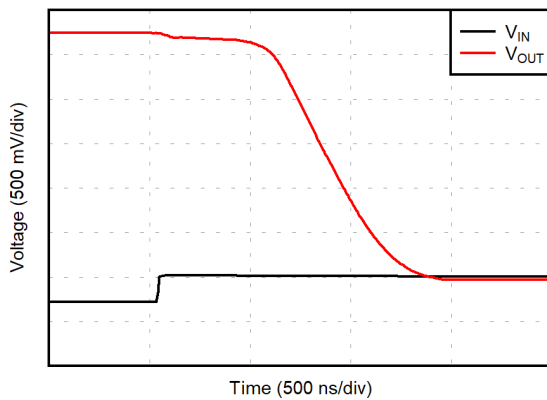

**Figure 6-33. Positive Overload Recovery**

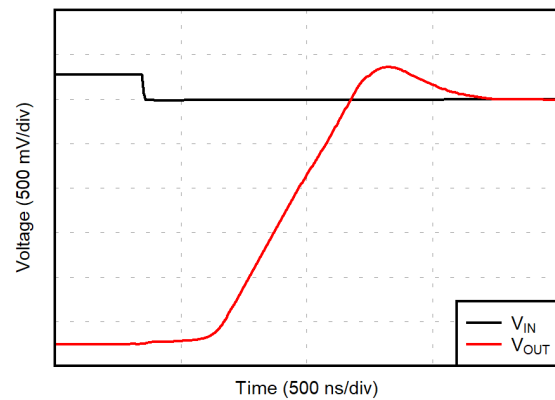

**Figure 6-34. Negative Overload Recovery**

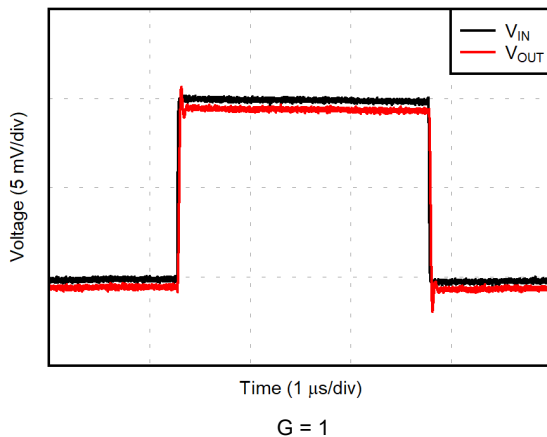

**Figure 6-35. Small-Signal Step Response (10-mV Step)**

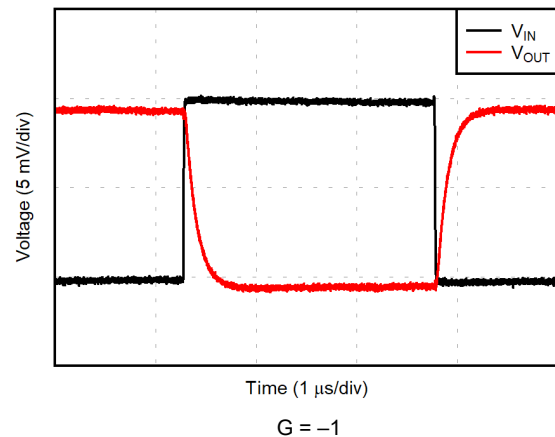

**Figure 6-36. Small-Signal Step Response (10-mV Step)**

## 6.8 Typical Characteristics (continued)

at  $T_A = 25^\circ\text{C}$ ,  $V_S = 5.5\text{ V}$ ,  $V_{CM} = V_S / 2$ ,  $R_{LOAD} = 10\text{ k}\Omega$  connected to  $V_S / 2$ , and  $C_L = 100\text{ pF}$  (unless otherwise noted)

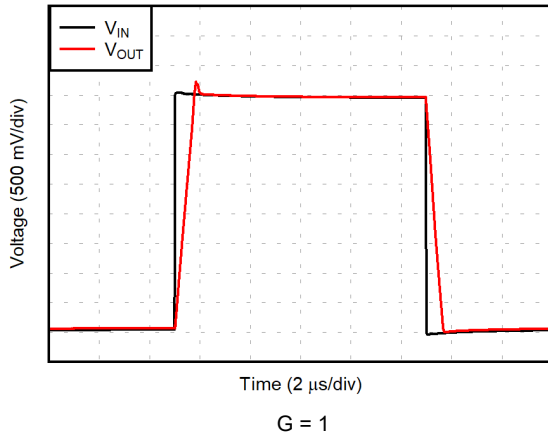

Figure 6-37. Large-Signal Step Response (4-V Step)

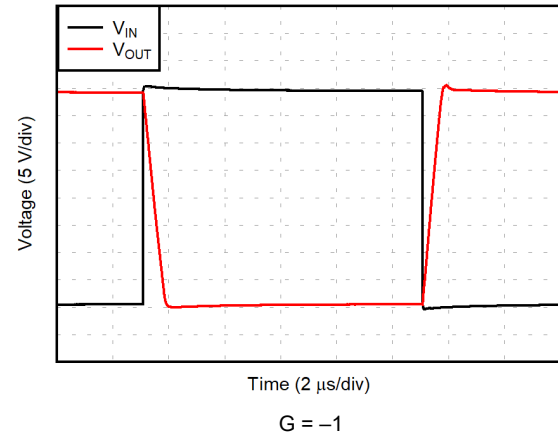

Figure 6-38. Large-Signal Step Response (4-V Step)

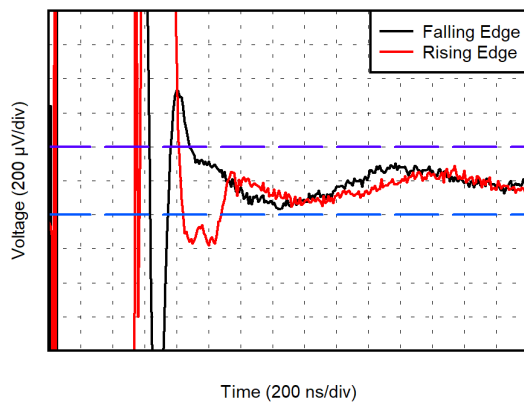

Figure 6-39. Settling Time

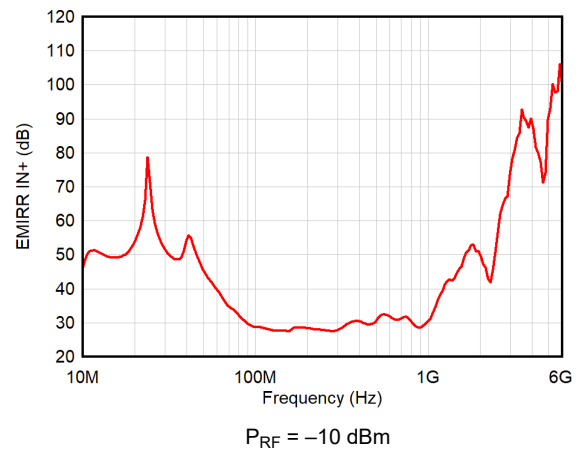

Figure 6-40. EMIRR vs Frequency

## 7 Detailed Description

### 7.1 Overview

The OPAx392 is a family of low offset, low-noise e-trim operational amplifiers (op amps) that uses a proprietary offset trim technique. These op amps offer ultra-low input offset voltage and drift and achieve excellent input and output dynamic linearity. The OPAx392 operate from 1.7 V to 5.5 V, are unity-gain stable, and are designed for a wide range of general-purpose and precision applications.

The amplifiers feature state-of-the-art CMOS technology and advanced design features that help achieve extremely low input bias current, wide input and output voltage ranges, high loop gain, and low, flat output impedance in small package options. The OPAx392 strengths also include 13-MHz bandwidth, 4.4-nV/ $\sqrt{\text{Hz}}$  noise spectral density, and low  $1/f$  noise. These features make the OPAx392 an exceptional choice for interfacing with sensors, photodiodes, and high-performance analog-to-digital converters (ADCs).

### 7.2 Functional Block Diagram

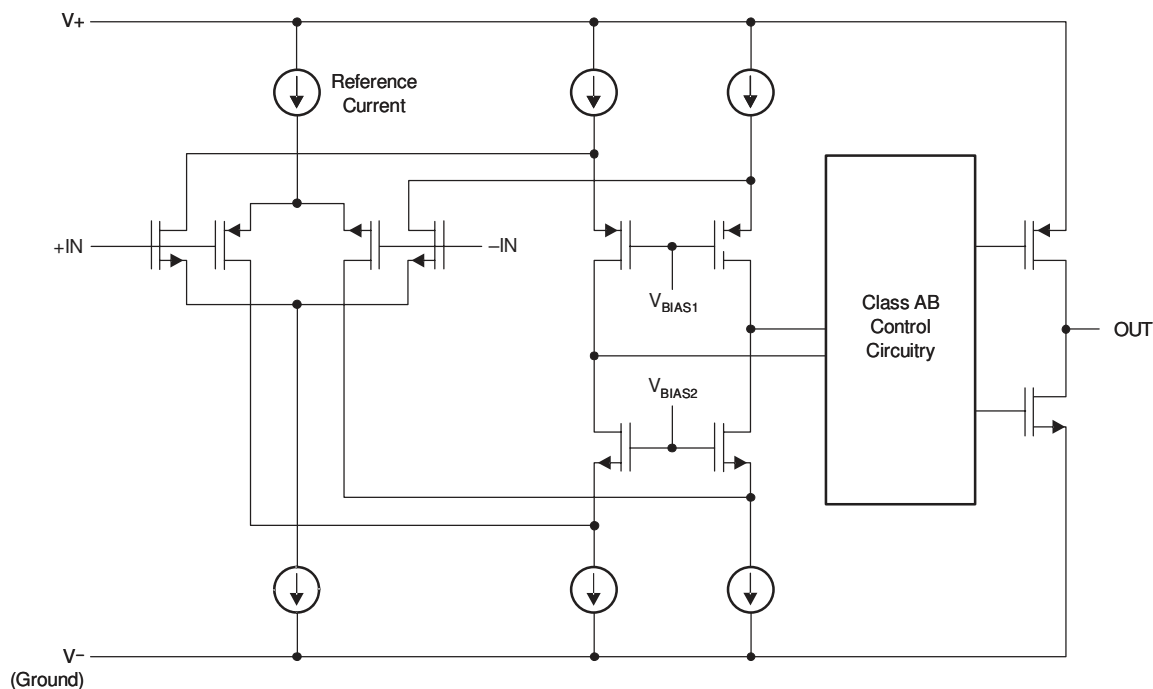

## 7.3 Feature Description

### 7.3.1 Low Operating Voltage

The OPAx392 family can be used with single or dual supplies from an operating range of  $V_S = 1.7\text{ V}$  ( $\pm 0.85\text{ V}$ ) up to  $5.5\text{ V}$  ( $\pm 2.75\text{ V}$ ). The offset voltage is trimmed at  $5.0\text{ V}$ , however, the device maintains ultra-low offset voltages down to  $V_S = 1.7\text{ V}$ .

Key parameters that vary over the supply voltage or temperature range are shown in the *Typical Characteristics*.

### 7.3.2 Low Input Bias Current

The typical input bias current of the OPAx392 is extremely low (typically  $10\text{ fA}$ ). Input bias current is dominated by leakage current from the ESD protection diodes, which is proportional to the area of the diode. The OPAx392 is able to achieve ultra-low input bias current as a result of modern process technology and advanced electrostatic discharge (ESD) protection design that minimizes the area of the diode.

In overdriven conditions, the bias current can increase significantly. The most common cause of an overdriven condition occurs when the operational amplifier is outside of the linear range of operation. When the output of the operational amplifier is driven to one of the supply rails, the feedback loop requirements cannot be satisfied and a differential input voltage develops across the input pins. This differential input voltage results in the forward-biasing of the ESD cells. [Figure 7-1](#) shows the equivalent circuit.

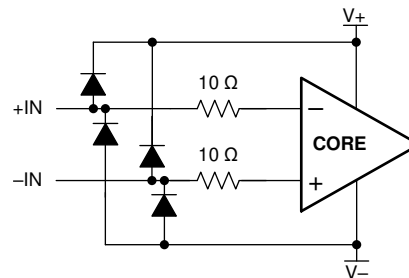

**Figure 7-1. Equivalent Input Circuit**

## 7.4 Device Functional Modes

The OPAx392 family is operational when the power-supply voltage is greater than  $1.7\text{ V}$  ( $\pm 0.85\text{ V}$ ). For devices that use the EN function (see [Section 5](#)), the devices are disabled when the EN pin is low. In this state, quiescent current is significantly reduced, and the output is high impedance. The maximum specified power-supply voltage for the OPAx392 is  $5.5\text{ V}$  ( $\pm 2.75\text{ V}$ ).

## 8 Application and Implementation

### Note

Information in the following applications sections is not part of the TI component specification, and TI does not warrant its accuracy or completeness. TI's customers are responsible for determining suitability of components for their purposes, as well as validating and testing their design implementation to confirm system functionality.

### 8.1 Application Information

The OPAx392 is a unity-gain stable, precision operational amplifier family free from unexpected output and phase reversal. The use of proprietary e-trim operational amplifier technology gives the benefit of low input offset voltage over time and temperature, along with ultra-low input bias current. The OPAx392 are optimized for full rail-to-rail input, allowing for low-voltage, single-supply operation or split-supply use. These miniature, high-precision, low-noise amplifiers offer high-impedance inputs that have a common-mode range to the supply rail, with low offset across the supply range, and a rail-to-rail output that swings within 5 mV of the supplies under normal test conditions. The OPAx392 precision amplifiers are designed for upstream analog signal chain applications in low or high gains, as well as downstream signal chain functions such as DAC buffering.

### 8.2 Typical Application

This single-supply, low-side, bidirectional current-sensing design example detects load currents from  $-1$  A to  $+1$  A. The single-ended output spans from 110 mV to 3.19 V. This design uses the OPA392 because of the low offset voltage and rail-to-rail input and output. One of the amplifiers is configured as a difference amplifier and the other amplifier provides the reference voltage.

Figure 8-1 shows the schematic.

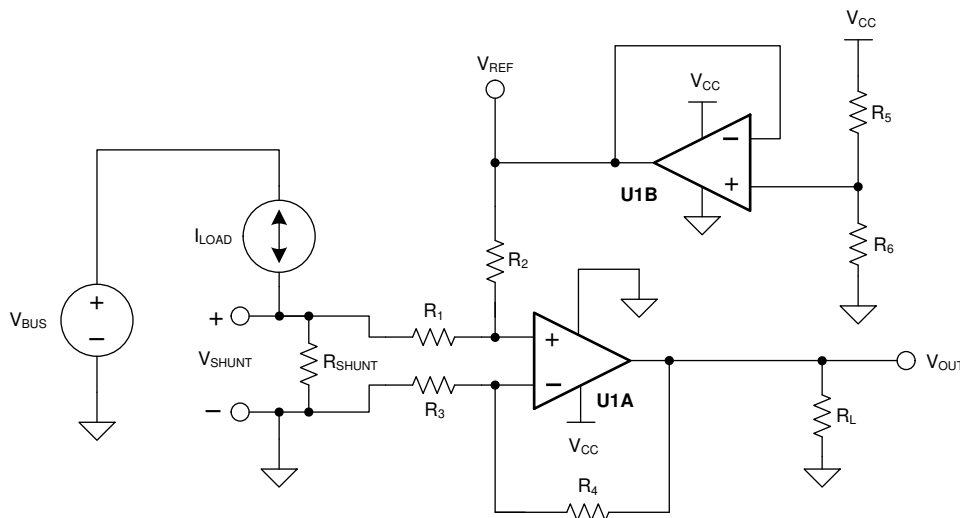

**Figure 8-1. Bidirectional Current-Sensing Schematic**

### 8.2.1 Design Requirements

This design example has the following requirements:

- Supply voltage: 3.3 V
- Input: –1 A to +1 A
- Output: 1.65 V ±1.54 V (110 mV to 3.19 V)

### 8.2.2 Detailed Design Procedure

The load current,  $I_{LOAD}$ , flows through the shunt resistor,  $R_{SHUNT}$ , to develop the shunt voltage,  $V_{SHUNT}$ . The shunt voltage is then amplified by the difference amplifier consisting of U1A and  $R_1$  through  $R_4$ . The gain of the difference amplifier is set by the ratio of  $R_4$  to  $R_3$ . To minimize errors, set  $R_2 = R_4$  and  $R_1 = R_3$ . The reference voltage,  $V_{REF}$ , is supplied by buffering a resistor divider using U1B. The transfer function is given by [Equation 1](#).

$$V_{OUT} = V_{SHUNT} \times \text{Gain}_{\text{Diff\_Amp}} + V_{REF} \quad (1)$$

where

- $V_{SHUNT} = I_{LOAD} \times R_{SHUNT}$
- $\text{Gain}_{\text{Diff\_Amp}} = \frac{R_4}{R_3}$
- $V_{REF} = V_{CC} \times \left[ \frac{R_6}{R_5 + R_6} \right]$

There are two types of errors in this design: offset and gain. Gain errors are introduced by the tolerance of the shunt resistor and the ratios of  $R_4$  to  $R_3$  and, similarly,  $R_2$  to  $R_1$ . Offset errors are introduced by the voltage divider ( $R_5$  and  $R_6$ ) and how closely the ratio of  $R_4 / R_3$  matches  $R_2 / R_1$ . The latter value affects the CMRR of the difference amplifier, ultimately translating to an offset error.

The value of  $V_{SHUNT}$  is the ground potential for the system load because  $V_{SHUNT}$  is a low-side measurement. Therefore, a maximum value must be placed on  $V_{SHUNT}$ . In this design, the maximum value for  $V_{SHUNT}$  is set to 100 mV. [Equation 2](#) calculates the maximum value of the shunt resistor given a maximum shunt voltage of 100 mV and maximum load current of 1 A.

$$R_{SHUNT(\text{Max})} = \frac{V_{SHUNT(\text{Max})}}{I_{LOAD(\text{Max})}} = \frac{100 \text{ mV}}{1 \text{ A}} = 100 \text{ m}\Omega \quad (2)$$

The tolerance of  $R_{SHUNT}$  is directly proportional to cost. For this design, a shunt resistor with a tolerance of 0.5% is selected. If greater accuracy is required, select a 0.1% resistor or better.

The load current is bidirectional; therefore, the shunt voltage range is –100 mV to +100 mV. This voltage is divided down by  $R_1$  and  $R_2$  before reaching the operational amplifier, U1A. Make sure that the voltage present at the noninverting node of U1A is within the common-mode range of the device. Therefore, use an operational amplifier, such as the OPA392, that has a common-mode range that extends below the negative supply voltage. Finally, to minimize offset error, the OPA392 has a typical offset voltage of merely  $\pm 0.25 \mu\text{V}$  ( $\pm 5 \mu\text{V}$  maximum).

Given a symmetric load current of –1 A to +1 A, the voltage divider resistors ( $R_5$  and  $R_6$ ) must be equal. To be consistent with the shunt resistor, a tolerance of 0.5% is selected. To minimize power consumption, 10-k $\Omega$  resistors are used.

To set the gain of the difference amplifier, the common-mode range and output swing of the OPA392 must be considered. Equation 3 and Equation 4 depict the typical common-mode range and maximum output swing, respectively, of the OPA392 given a 3.3-V supply.

$$-100 \text{ mV} < V_{\text{CM}} < 3.4 \text{ V} \quad (3)$$

$$100 \text{ mV} < V_{\text{OUT}} < 3.2 \text{ V} \quad (4)$$

The gain of the difference amplifier can now be calculated as shown in Equation 5:

$$\text{Gain}_{\text{Diff\_Amp}} = \frac{V_{\text{OUT\_Max}} - V_{\text{OUT\_Min}}}{R_{\text{SHUNT}} \times (I_{\text{MAX}} - I_{\text{MIN}})} = \frac{3.2 \text{ V} - 100 \text{ mV}}{100 \text{ m}\Omega \times [1 \text{ A} - (-1 \text{ A})]} = 15.5 \frac{\text{V}}{\text{V}} \quad (5)$$

The resistor value selected for  $R_1$  and  $R_3$  is 1 k $\Omega$ . 15.4 k $\Omega$  is selected for  $R_2$  and  $R_4$  because this number is the nearest standard value. Therefore, the calculated gain of the difference amplifier is 15.4 V/V.

The gain error of the circuit primarily depends on  $R_1$  through  $R_4$ . As a result of this dependence, 0.1% resistors are selected. This configuration reduces the likelihood that the design requires a two-point calibration. A simple one-point calibration, if desired, removes the offset errors introduced by the 0.5% resistors.

### 8.2.3 Application Curve

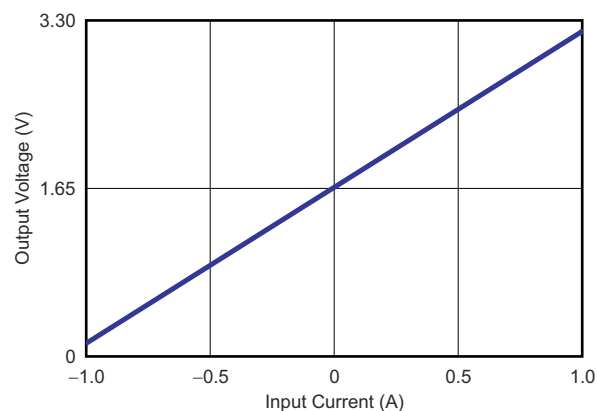

**Figure 8-2. Bidirectional Current-Sensing Circuit Performance: Output Voltage vs Input Current**

### 8.3 Power Supply Recommendations

The OPAx392 are specified for operation from 1.7 V to 5.5 V ( $\pm 0.85$  V to  $\pm 2.75$  V).

**CAUTION**

Exceeding supply voltages listed in the *Absolute Maximum Ratings* table can permanently damage the device.

### 8.4 Layout

#### 8.4.1 Layout Guidelines

Pay attention to good layout practice. Keep traces short, and when possible, use a printed-circuit board (PCB) ground plane with surface-mount components placed as close to the device pins as possible. Place a 0.1- $\mu$ F capacitor closely across the supply pins. These guidelines must be applied throughout the analog circuit to improve performance and provide benefits such as reducing the electromagnetic interference (EMI) susceptibility.

For lowest offset voltage and precision performance, circuit layout and mechanical conditions must be optimized. Avoid temperature gradients that create thermoelectric (Seebeck) effects in the thermocouple junctions formed from connecting dissimilar conductors. These thermally-generated potentials can be made to cancel by making sure these potentials are equal on both input terminals. Other layout and design considerations include:

- Use low thermoelectric-coefficient conditions (avoid dissimilar metals).
- Use guard traces to minimize leakage current when ultra-low bias current is required.
- Thermally isolate components from power supplies or other heat sources.
- Shield operational amplifier and input circuitry from air currents, such as cooling fans.

Following these guidelines reduces the likelihood of junctions being at different temperatures, which can cause thermoelectric voltage drift of 0.1  $\mu$ V/ $^{\circ}$ C or higher, depending on materials used.

#### 8.4.2 Layout Example

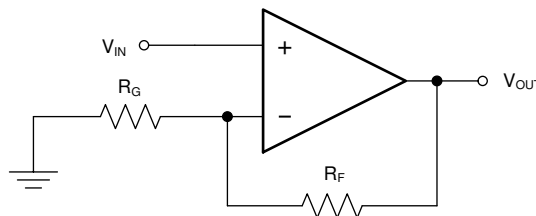

**Figure 8-3. OPA392 Layout Schematic**

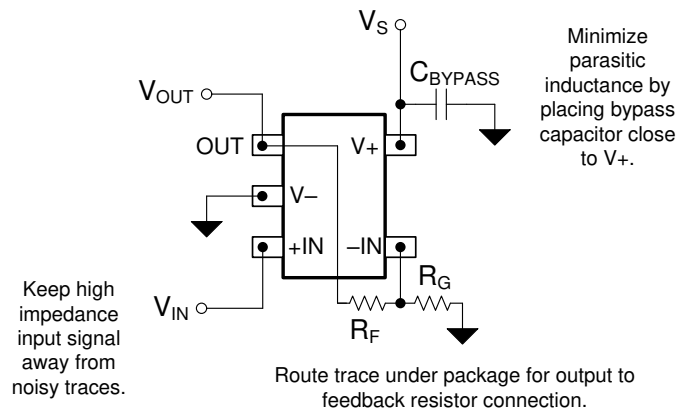

**Figure 8-4. OPA392 Layout Example**

## 9 Device and Documentation Support

### 9.1 Device Support

#### 9.1.1 Development Support

##### 9.1.1.1 PSpice® for TI

PSpice® for TI is a design and simulation environment that helps evaluate performance of analog circuits. Create subsystem designs and prototype solutions before committing to layout and fabrication, reducing development cost and time to market.

##### 9.1.1.2 TINA-TI™ Simulation Software (Free Download)

TINA-TI™ simulation software is a simple, powerful, and easy-to-use circuit simulation program based on a SPICE engine. TINA-TI simulation software is a free, fully-functional version of the TINA™ software, preloaded with a library of macromodels, in addition to a range of both passive and active models. TINA-TI simulation software provides all the conventional dc, transient, and frequency domain analysis of SPICE, as well as additional design capabilities.

Available as a [free download](#) from the [Design and simulation tools](#) web page, TINA-TI simulation software offers extensive post-processing capability that allows users to format results in a variety of ways. Virtual instruments offer the ability to select input waveforms and probe circuit nodes, voltages, and waveforms, creating a dynamic quick-start tool.

---

#### Note

These files require that either the TINA software or TINA-TI software be installed. Download the free TINA-TI simulation software from the [TINA-TI™ software folder](#).

---

### 9.2 Documentation Support

#### 9.2.1 Related Documentation

For related documentation see the following:

- Texas Instruments, [Amplifier Input Common-Mode and Output-Swing Limitations application note](#)
- Texas Instruments, [Offset Correction Methods: Laser Trim, e-Trim™, and Chopper application brief](#)

### 9.3 Receiving Notification of Documentation Updates

To receive notification of documentation updates, navigate to the device product folder on [ti.com](#). Click on *Notifications* to register and receive a weekly digest of any product information that has changed. For change details, review the revision history included in any revised document.

### 9.4 Support Resources

[TI E2E™ support forums](#) are an engineer's go-to source for fast, verified answers and design help — straight from the experts. Search existing answers or ask your own question to get the quick design help you need.

Linked content is provided "AS IS" by the respective contributors. They do not constitute TI specifications and do not necessarily reflect TI's views; see TI's [Terms of Use](#).

### 9.5 Trademarks

e-trim™, TINA-TI™, and TI E2E™ are trademarks of Texas Instruments.

TINA™ is a trademark of DesignSoft, Inc.

PSpice® is a registered trademark of Cadence Design Systems, Inc.

All trademarks are the property of their respective owners.

## 9.6 Electrostatic Discharge Caution



This integrated circuit can be damaged by ESD. Texas Instruments recommends that all integrated circuits be handled with appropriate precautions. Failure to observe proper handling and installation procedures can cause damage.

ESD damage can range from subtle performance degradation to complete device failure. Precision integrated circuits may be more susceptible to damage because very small parametric changes could cause the device not to meet its published specifications.

## 9.7 Glossary

[TI Glossary](#) This glossary lists and explains terms, acronyms, and definitions.

## 10 Revision History

NOTE: Page numbers for previous revisions may differ from page numbers in the current version.

<b>Changes from Revision H (April 2024) to Revision I (March 2025)</b>	<b>Page</b>
• Changed status of OPA4392 PW (TSSOP, 14) from preview to production data (active) and added associated content.....	1

<b>Changes from Revision G (April 2024) to Revision H (November 2024)</b>	<b>Page</b>
• Changed status of OPA392 DCK (SC70, 5) and OPA2392 DSG (WSON, 8) packages from preview to production data (active) and added associated content.....	1
• Changed max $V_{OS}$ of OPA2392DGK for overtemperature range condition from $\pm 125\mu V$ to $\pm 180\mu V$ based on the latest characterization data.....	8
• Changed typical phase margin specification of OPA392YBJ and OPA2392D, DGK, and YBJ from $45^\circ$ to $35^\circ$ based on the latest characterization data.....	8

<b>Changes from Revision F (December 2023) to Revision G (April 2024)</b>	<b>Page</b>
• Changed OPA2392 DGK (VSSOP, 8) package status from advanced information (preview with samples) to production data (active) and added associated content.....	1

<b>Changes from Revision E (September 2023) to Revision F (December 2023)</b>	<b>Page</b>
• Changed OPA392 YBJ (DSBGA, 6) package status from advanced information (preview with samples) to production data (active) and added associated content.....	1
• Changed OPA2392 D (SOIC, 8) package status from preview to production data (active) and added associated content.....	1
• Changed OPA2392 DGK (VSSOP, 8) package status from preview to advanced information (preview with samples) and added associated content.....	1

## 11 Mechanical, Packaging, and Orderable Information

The following pages include mechanical packaging and orderable information. This information is the most current data available for the designated devices. This data is subject to change without notice and revision of this document. For browser-based versions of this data sheet, refer to the left-hand navigation.

**YBJ0006**

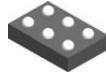

**PACKAGE OUTLINE**  
**DSBGA - 0.35 mm max height**

DIE SIZE BALL GRID ARRAY

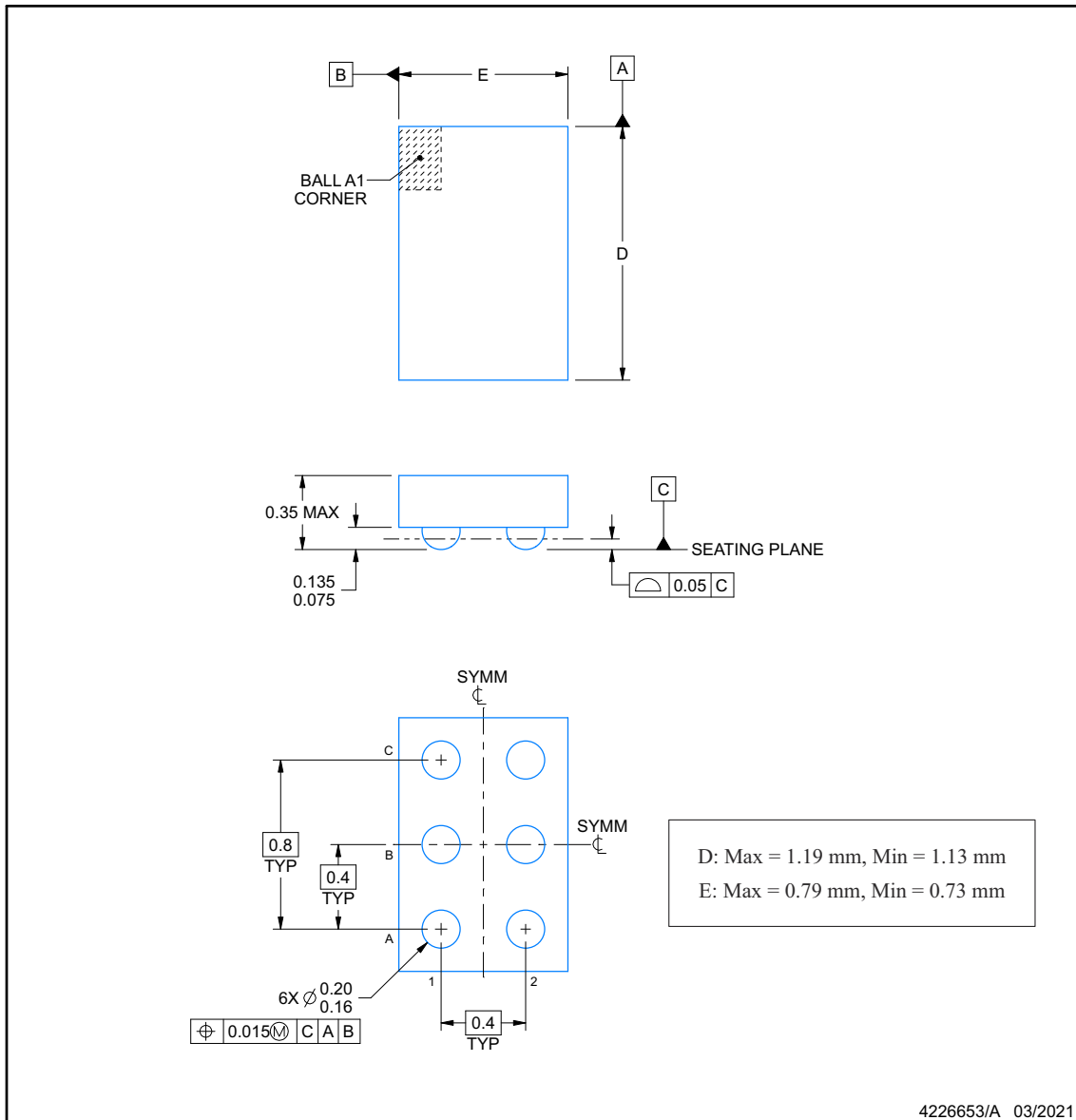

## EXAMPLE BOARD LAYOUT

**YBJ0006**

**DSBGA - 0.35 mm max height**

DIE SIZE BALL GRID ARRAY

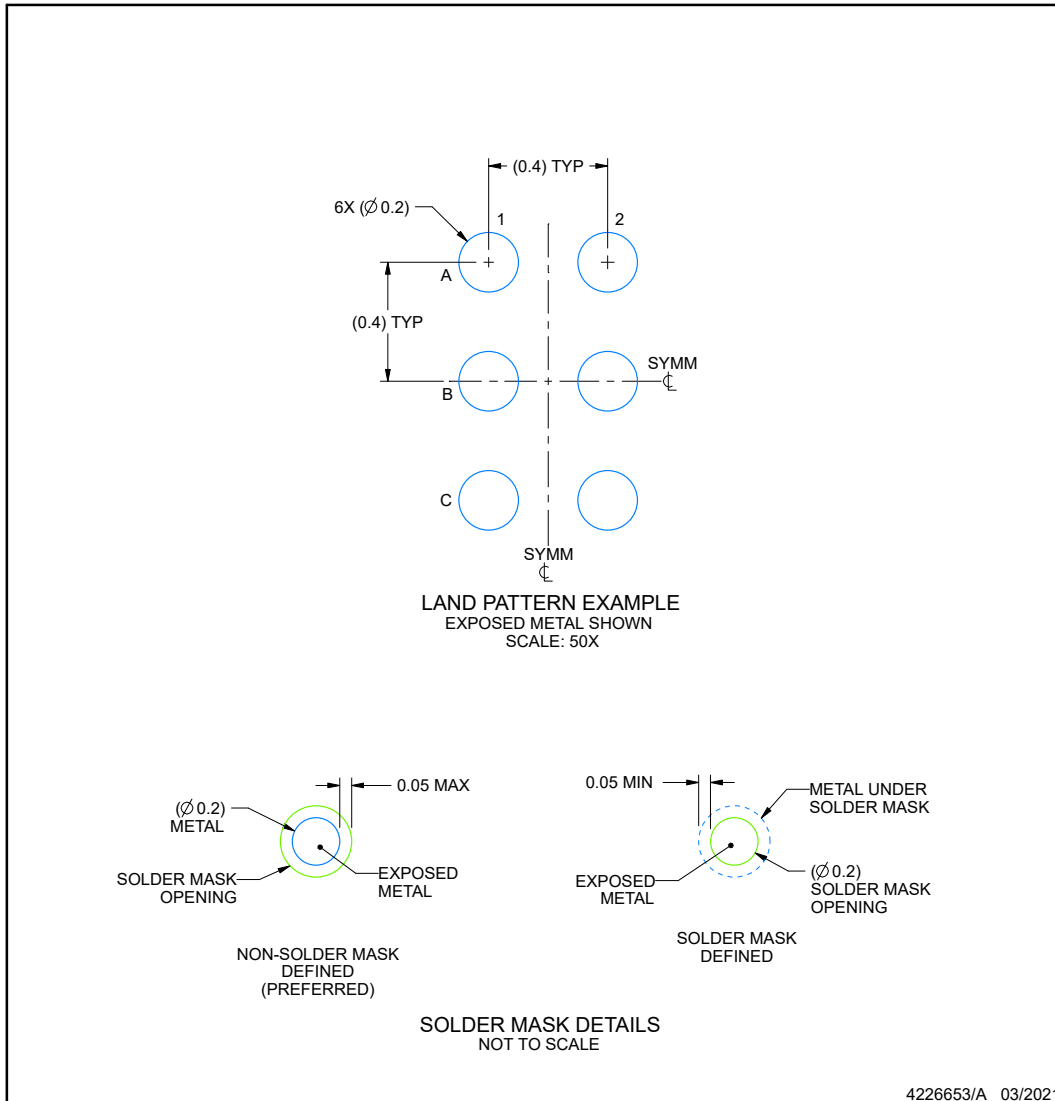

NOTES: (continued)

- Final dimensions may vary due to manufacturing tolerance considerations and also routing constraints. See Texas Instruments Literature No. SNVA009 ([www.ti.com/lit/snva009](http://www.ti.com/lit/snva009)).

## EXAMPLE STENCIL DESIGN

**YBJ0006**

**DSBGA - 0.35 mm max height**

DIE SIZE BALL GRID ARRAY

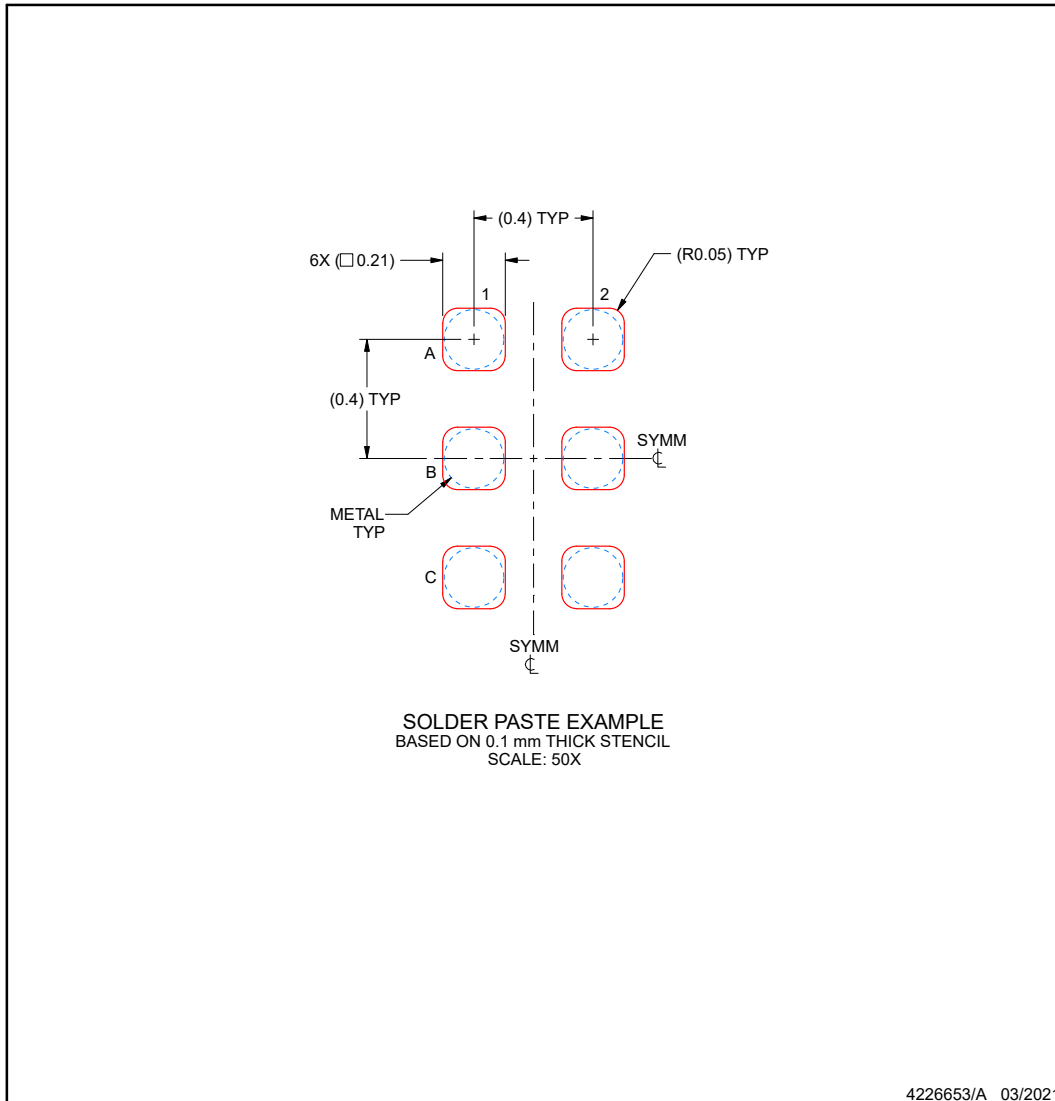

NOTES: (continued)

4. Laser cutting apertures with trapezoidal walls and rounded corners may offer better paste release.

**PACKAGING INFORMATION**

Orderable part number	Status (1)	Material type (2)	Package   Pins	Package qty   Carrier	RoHS (3)	Lead finish/ Ball material (4)	MSL rating/ Peak reflow (5)	Op temp (°C)	Part marking (6)
<a href="#">OPA2392DGKR</a>	Active	Production	VSSOP (DGK)   8	2500   LARGE T&R	Yes	NIPDAU	Level-2-260C-1 YEAR	-40 to 125	3BJS
OPA2392DGKR.A	Active	Production	VSSOP (DGK)   8	2500   LARGE T&R	Yes	NIPDAU	Level-2-260C-1 YEAR	-40 to 125	3BJS
<a href="#">OPA2392DR</a>	Active	Production	SOIC (D)   8	3000   LARGE T&R	Yes	NIPDAU	Level-1-260C-UNLIM	-40 to 125	O2392D
OPA2392DR.A	Active	Production	SOIC (D)   8	3000   LARGE T&R	Yes	NIPDAU	Level-1-260C-UNLIM	-40 to 125	O2392D
<a href="#">OPA2392DSGR</a>	Active	Production	WSON (DSG)   8	3000   LARGE T&R	Yes	NIPDAU	Level-1-260C-UNLIM	-40 to 125	3B8H
OPA2392DSGR.A	Active	Production	WSON (DSG)   8	3000   LARGE T&R	Yes	NIPDAU	Level-1-260C-UNLIM	-40 to 125	3B8H
<a href="#">OPA2392YBJR</a>	Active	Production	DSBGA (YBJ)   9	3000   LARGE T&R	Yes	SNAGCU	Level-1-260C-UNLIM	-40 to 125	O23
OPA2392YBJR.A	Active	Production	DSBGA (YBJ)   9	3000   LARGE T&R	Yes	SNAGCU	Level-1-260C-UNLIM	-40 to 125	O23
<a href="#">OPA2392YBJT</a>	Active	Production	DSBGA (YBJ)   9	250   SMALL T&R	Yes	SNAGCU	Level-1-260C-UNLIM	-40 to 125	O23
OPA2392YBJT.A	Active	Production	DSBGA (YBJ)   9	250   SMALL T&R	Yes	SNAGCU	Level-1-260C-UNLIM	-40 to 125	O23
<a href="#">OPA392DBVR</a>	Active	Production	SOT-23 (DBV)   5	3000   LARGE T&R	Yes	NIPDAU	Level-1-260C-UNLIM	-40 to 125	23GT
OPA392DBVR.A	Active	Production	SOT-23 (DBV)   5	3000   LARGE T&R	Yes	NIPDAU	Level-1-260C-UNLIM	-40 to 125	23GT
<a href="#">OPA392DBVT</a>	Active	Production	SOT-23 (DBV)   5	250   SMALL T&R	Yes	NIPDAU	Level-1-260C-UNLIM	-40 to 125	23GT
OPA392DBVT.A	Active	Production	SOT-23 (DBV)   5	250   SMALL T&R	Yes	NIPDAU	Level-1-260C-UNLIM	-40 to 125	23GT
<a href="#">OPA392DCKR</a>	Active	Production	SC70 (DCK)   5	3000   LARGE T&R	Yes	NIPDAU	Level-1-260C-UNLIM	-40 to 125	1QL
OPA392DCKR.A	Active	Production	SC70 (DCK)   5	3000   LARGE T&R	Yes	NIPDAU	Level-1-260C-UNLIM	-40 to 125	1QL
<a href="#">OPA392YBJR</a>	Active	Production	DSBGA (YBJ)   6	3000   LARGE T&R	Yes	SNAGCU	Level-1-260C-UNLIM	-40 to 125	PL
OPA392YBJR.A	Active	Production	DSBGA (YBJ)   6	3000   LARGE T&R	Yes	SNAGCU	Level-1-260C-UNLIM	-40 to 125	PL
<a href="#">OPA4392PWR</a>	Active	Production	TSSOP (PW)   14	3000   LARGE T&R	Yes	NIPDAU	Level-2-260C-1 YEAR	-40 to 125	OPA4392
OPA4392PWR.A	Active	Production	TSSOP (PW)   14	3000   LARGE T&R	Yes	NIPDAU	Level-2-260C-1 YEAR	-40 to 125	OPA4392

(1) **Status:** For more details on status, see our [product life cycle](#).

(2) **Material type:** When designated, preproduction parts are prototypes/experimental devices, and are not yet approved or released for full production. Testing and final process, including without limitation quality assurance, reliability performance testing, and/or process qualification, may not yet be complete, and this item is subject to further changes or possible discontinuation. If available for ordering, purchases will be subject to an additional waiver at checkout, and are intended for early internal evaluation purposes only. These items are sold without warranties of any kind.

(3) **RoHS values:** Yes, No, RoHS Exempt. See the [TI RoHS Statement](#) for additional information and value definition.

(4) **Lead finish/Ball material:** Parts may have multiple material finish options. Finish options are separated by a vertical ruled line. Lead finish/Ball material values may wrap to two lines if the finish value exceeds the maximum column width.

(5) **MSL rating/Peak reflow:** The moisture sensitivity level ratings and peak solder (reflow) temperatures. In the event that a part has multiple moisture sensitivity ratings, only the lowest level per JEDEC standards is shown. Refer to the shipping label for the actual reflow temperature that will be used to mount the part to the printed circuit board.

(6) **Part marking:** There may be an additional marking, which relates to the logo, the lot trace code information, or the environmental category of the part.

Multiple part markings will be inside parentheses. Only one part marking contained in parentheses and separated by a "~" will appear on a part. If a line is indented then it is a continuation of the previous line and the two combined represent the entire part marking for that device.

**Important Information and Disclaimer:** The information provided on this page represents TI's knowledge and belief as of the date that it is provided. TI bases its knowledge and belief on information provided by third parties, and makes no representation or warranty as to the accuracy of such information. Efforts are underway to better integrate information from third parties. TI has taken and continues to take reasonable steps to provide representative and accurate information but may not have conducted destructive testing or chemical analysis on incoming materials and chemicals. TI and TI suppliers consider certain information to be proprietary, and thus CAS numbers and other limited information may not be available for release.

In no event shall TI's liability arising out of such information exceed the total purchase price of the TI part(s) at issue in this document sold by TI to Customer on an annual basis.

**TAPE AND REEL INFORMATION**

**QUADRANT ASSIGNMENTS FOR PIN 1 ORIENTATION IN TAPE**

\*All dimensions are nominal

Device	Package Type	Package Drawing	Pins	SPQ	Reel Diameter (mm)	Reel Width W1 (mm)	A0 (mm)	B0 (mm)	K0 (mm)	P1 (mm)	W (mm)	Pin1 Quadrant
OPA2392DGKR	VSSOP	DGK	8	2500	330.0	12.4	5.3	3.4	1.4	8.0	12.0	Q1
OPA2392DR	SOIC	D	8	3000	330.0	12.4	6.4	5.2	2.1	8.0	12.0	Q1
OPA2392DSGR	WSO8	DSG	8	3000	180.0	8.4	2.3	2.3	1.15	4.0	8.0	Q2
OPA2392YBJR	DSBGA	YBJ	9	3000	180.0	8.4	1.26	1.26	0.43	4.0	8.0	Q1
OPA2392YBJT	DSBGA	YBJ	9	250	180.0	8.4	1.26	1.26	0.43	4.0	8.0	Q1
OPA392DBVR	SOT-23	DBV	5	3000	178.0	9.0	3.3	3.2	1.4	4.0	8.0	Q3
OPA392DBVT	SOT-23	DBV	5	250	178.0	9.0	3.3	3.2	1.4	4.0	8.0	Q3
OPA392DCKR	SC70	DCK	5	3000	178.0	9.0	2.4	2.5	1.2	4.0	8.0	Q3
OPA392YBJR	DSBGA	YBJ	6	3000	180.0	8.4	0.85	1.27	0.43	2.0	8.0	Q1
OPA4392PWR	TSSOP	PW	14	3000	330.0	12.4	6.9	5.6	1.6	8.0	12.0	Q1

**TAPE AND REEL BOX DIMENSIONS**

\*All dimensions are nominal

Device	Package Type	Package Drawing	Pins	SPQ	Length (mm)	Width (mm)	Height (mm)
OPA2392DGKR	VSSOP	DGK	8	2500	353.0	353.0	32.0
OPA2392DR	SOIC	D	8	3000	356.0	356.0	35.0
OPA2392DSGR	WSON	DSG	8	3000	210.0	185.0	35.0
OPA2392YBJR	DSBGA	YBJ	9	3000	182.0	182.0	20.0
OPA2392YBJT	DSBGA	YBJ	9	250	182.0	182.0	20.0
OPA392DBVR	SOT-23	DBV	5	3000	180.0	180.0	18.0
OPA392DBVT	SOT-23	DBV	5	250	180.0	180.0	18.0
OPA392DCKR	SC70	DCK	5	3000	180.0	180.0	18.0
OPA392YBJR	DSBGA	YBJ	6	3000	182.0	182.0	20.0
OPA4392PWR	TSSOP	PW	14	3000	353.0	353.0	32.0



# EXAMPLE BOARD LAYOUT

DBV0005A

SOT-23 - 1.45 mm max height

SMALL OUTLINE TRANSISTOR



LAND PATTERN EXAMPLE  
EXPOSED METAL SHOWN  
SCALE:15X

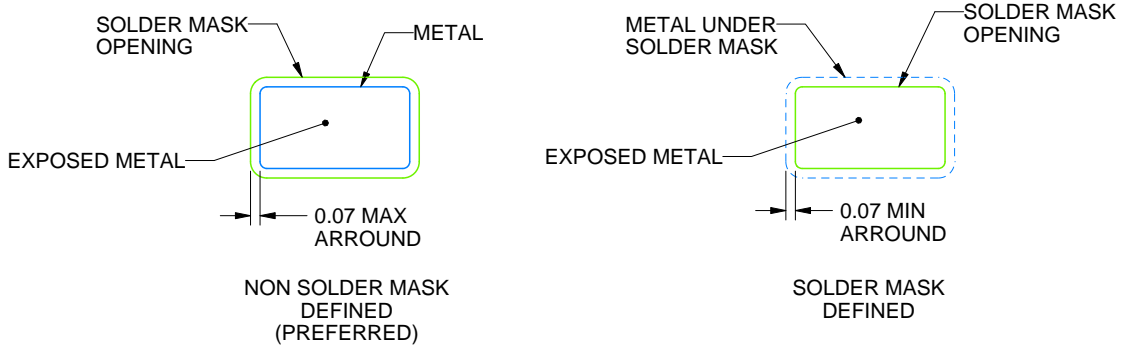

SOLDER MASK DETAILS

4214839/K 08/2024

NOTES: (continued)

- 6. Publication IPC-7351 may have alternate designs.
- 7. Solder mask tolerances between and around signal pads can vary based on board fabrication site.

# EXAMPLE STENCIL DESIGN

DBV0005A

SOT-23 - 1.45 mm max height

SMALL OUTLINE TRANSISTOR



SOLDER PASTE EXAMPLE  
BASED ON 0.125 mm THICK STENCIL  
SCALE:15X

4214839/K 08/2024

NOTES: (continued)

8. Laser cutting apertures with trapezoidal walls and rounded corners may offer better paste release. IPC-7525 may have alternate design recommendations.
9. Board assembly site may have different recommendations for stencil design.

# DGK0008A



# PACKAGE OUTLINE

VSSOP - 1.1 mm max height

SMALL OUTLINE PACKAGE

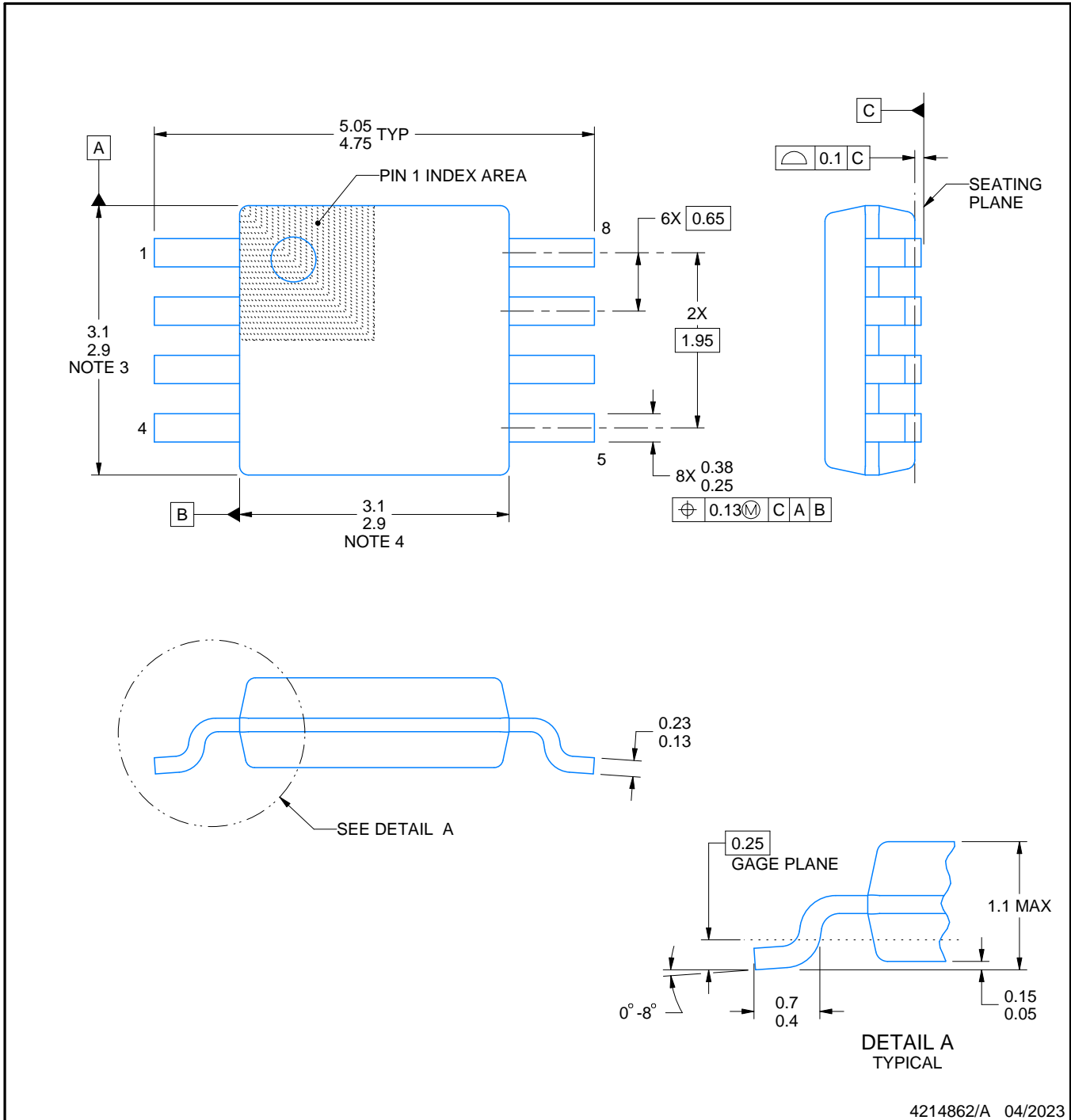

4214862/A 04/2023

**NOTES:**

PowerPAD is a trademark of Texas Instruments.

1. All linear dimensions are in millimeters. Any dimensions in parenthesis are for reference only. Dimensioning and tolerancing per ASME Y14.5M.
2. This drawing is subject to change without notice.
3. This dimension does not include mold flash, protrusions, or gate burrs. Mold flash, protrusions, or gate burrs shall not exceed 0.15 mm per side.
4. This dimension does not include interlead flash. Interlead flash shall not exceed 0.25 mm per side.
5. Reference JEDEC registration MO-187.

# EXAMPLE BOARD LAYOUT

DGK0008A

™ VSSOP - 1.1 mm max height

SMALL OUTLINE PACKAGE



LAND PATTERN EXAMPLE  
EXPOSED METAL SHOWN  
SCALE: 15X



SOLDER MASK DETAILS

4214862/A 04/2023

NOTES: (continued)

6. Publication IPC-7351 may have alternate designs.
7. Solder mask tolerances between and around signal pads can vary based on board fabrication site.
8. Vias are optional depending on application, refer to device data sheet. If any vias are implemented, refer to their locations shown on this view. It is recommended that vias under paste be filled, plugged or tented.
9. Size of metal pad may vary due to creepage requirement.

# EXAMPLE STENCIL DESIGN

DGK0008A

<sup>TM</sup> VSSOP - 1.1 mm max height

SMALL OUTLINE PACKAGE



SOLDER PASTE EXAMPLE  
SCALE: 15X

4214862/A 04/2023

NOTES: (continued)

11. Laser cutting apertures with trapezoidal walls and rounded corners may offer better paste release. IPC-7525 may have alternate design recommendations.
12. Board assembly site may have different recommendations for stencil design.

YBJ0009

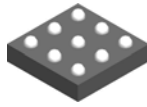

# PACKAGE OUTLINE

DSBGA - 0.35 mm max height

DIE SIZE BALL GRID ARRAY

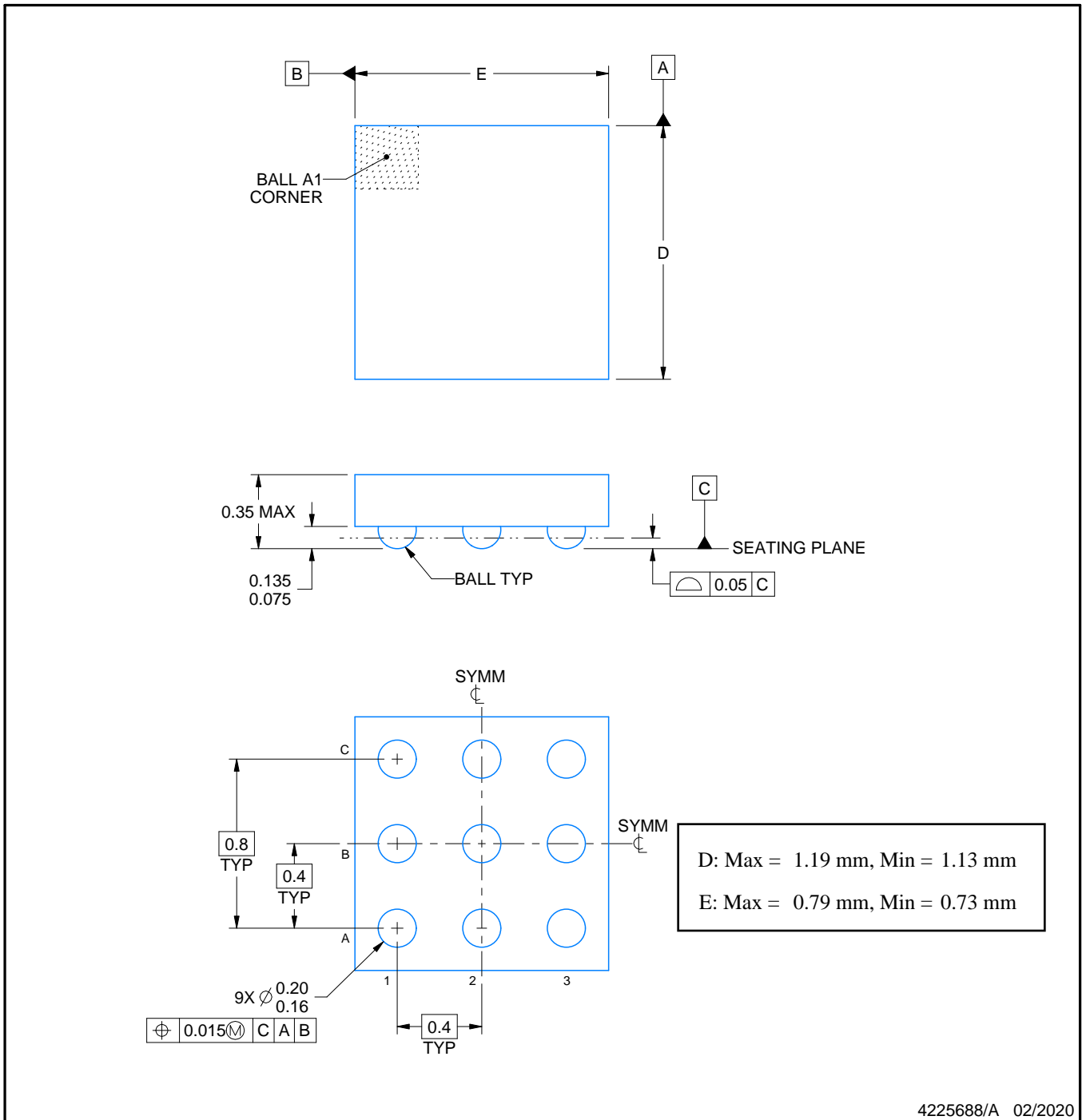

NOTES:

1. All linear dimensions are in millimeters. Any dimensions in parenthesis are for reference only. Dimensioning and tolerancing per ASME Y14.5M.
2. This drawing is subject to change without notice.

# EXAMPLE BOARD LAYOUT

YBJ0009

DSBGA - 0.35 mm max height

DIE SIZE BALL GRID ARRAY

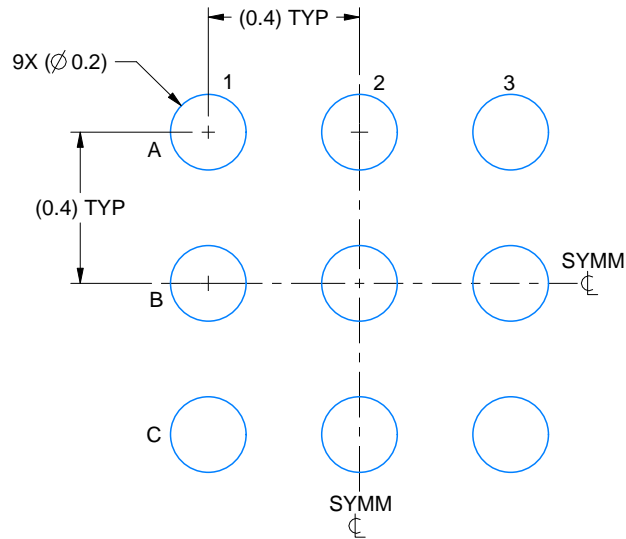

LAND PATTERN EXAMPLE  
EXPOSED METAL SHOWN  
SCALE: 50X

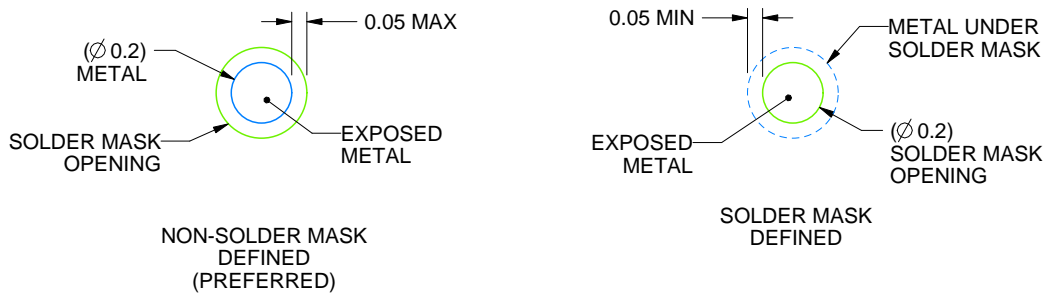

SOLDER MASK DETAILS  
NOT TO SCALE

4225688/A 02/2020

NOTES: (continued)

- Final dimensions may vary due to manufacturing tolerance considerations and also routing constraints. See Texas Instruments Literature No. SNVA009 ([www.ti.com/lit/snva009](http://www.ti.com/lit/snva009)).

# EXAMPLE STENCIL DESIGN

YBJ0009

DSBGA - 0.35 mm max height

DIE SIZE BALL GRID ARRAY

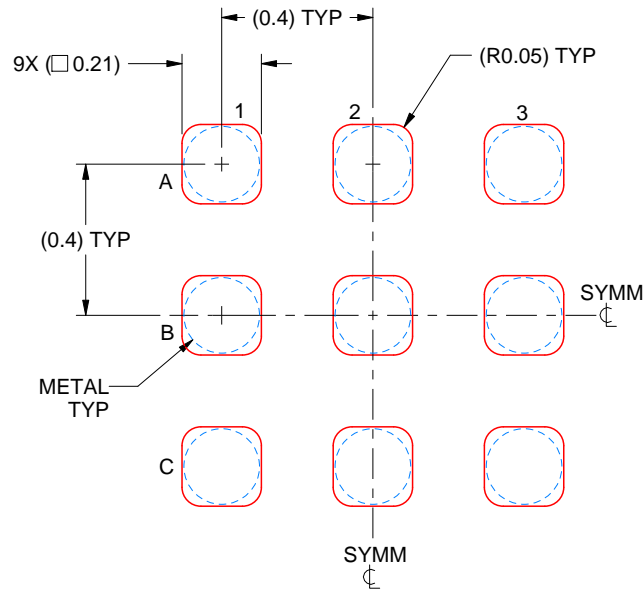

SOLDER PASTE EXAMPLE  
BASED ON 0.1 mm THICK STENCIL  
SCALE: 50X

4225688/A 02/2020

NOTES: (continued)

4. Laser cutting apertures with trapezoidal walls and rounded corners may offer better paste release.

# DCK0005A



## PACKAGE OUTLINE

SOT - 1.1 max height

SMALL OUTLINE TRANSISTOR

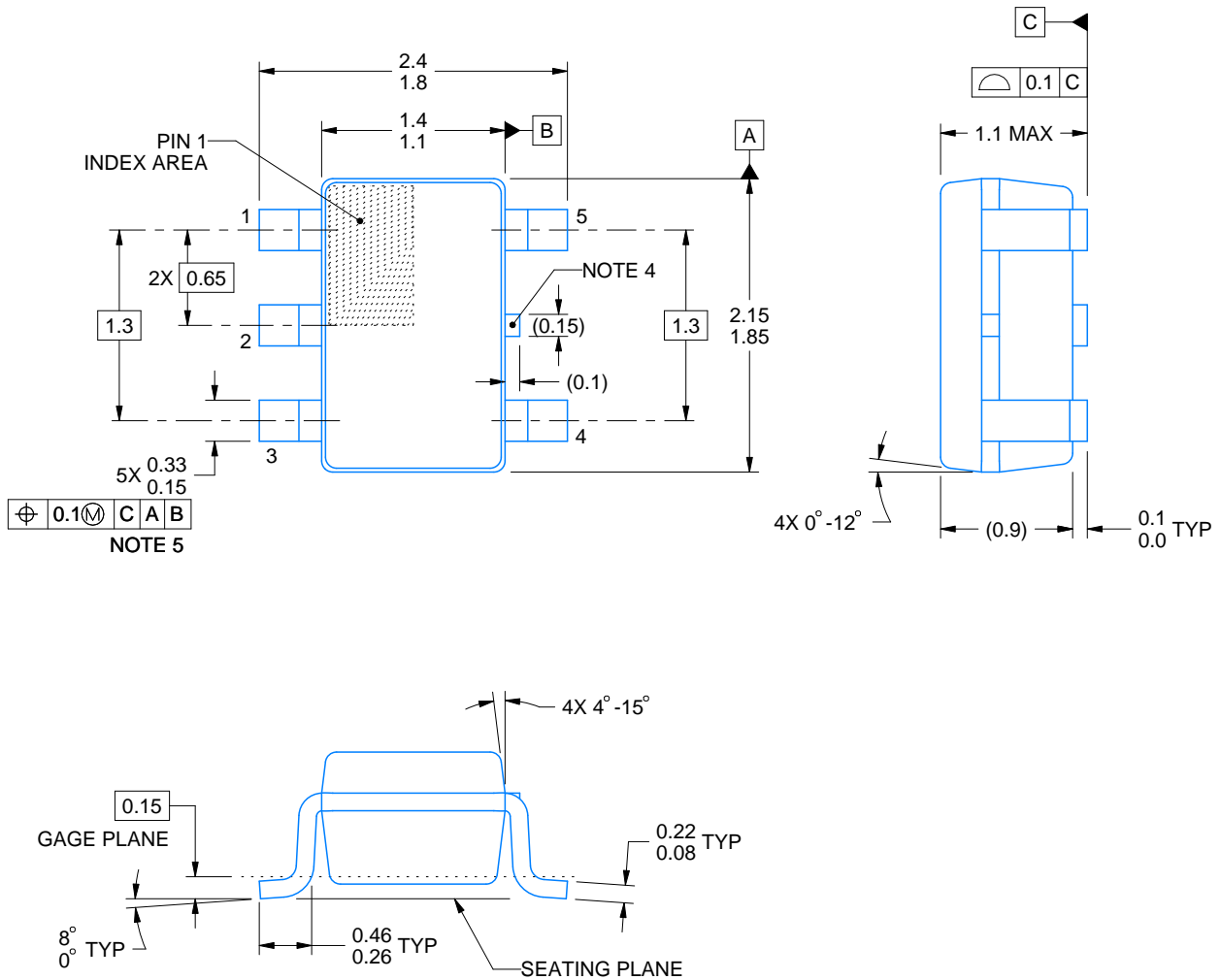

4214834/G 11/2024

### NOTES:

1. All linear dimensions are in millimeters. Any dimensions in parenthesis are for reference only. Dimensioning and tolerancing per ASME Y14.5M.
2. This drawing is subject to change without notice.
3. Reference JEDEC MO-203.
4. Support pin may differ or may not be present.
5. Lead width does not comply with JEDEC.
6. Body dimensions do not include mold flash, protrusions, or gate burrs. Mold flash, protrusions, or gate burrs shall not exceed 0.25mm per side

# EXAMPLE BOARD LAYOUT

DCK0005A

SOT - 1.1 max height

SMALL OUTLINE TRANSISTOR



LAND PATTERN EXAMPLE  
EXPOSED METAL SHOWN  
SCALE:18X

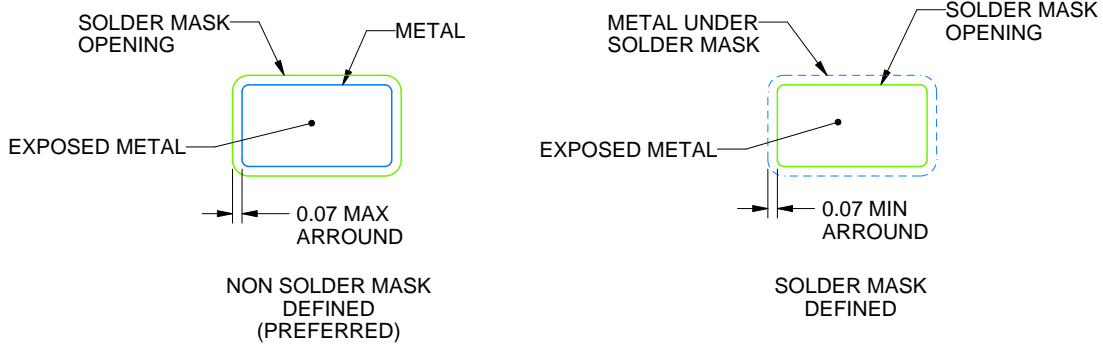

SOLDER MASK DETAILS

4214834/G 11/2024

NOTES: (continued)

- 7. Publication IPC-7351 may have alternate designs.
- 8. Solder mask tolerances between and around signal pads can vary based on board fabrication site.

# EXAMPLE STENCIL DESIGN

DCK0005A

SOT - 1.1 max height

SMALL OUTLINE TRANSISTOR



SOLDER PASTE EXAMPLE  
BASED ON 0.125 THICK STENCIL  
SCALE: 18X

4214834/G 11/2024

NOTES: (continued)

9. Laser cutting apertures with trapezoidal walls and rounded corners may offer better paste release. IPC-7525 may have alternate design recommendations.
10. Board assembly site may have different recommendations for stencil design.



D0008A

# PACKAGE OUTLINE

SOIC - 1.75 mm max height

SMALL OUTLINE INTEGRATED CIRCUIT



4214825/C 02/2019

### NOTES:

- Linear dimensions are in inches [millimeters]. Dimensions in parenthesis are for reference only. Controlling dimensions are in inches. Dimensioning and tolerancing per ASME Y14.5M.
- This drawing is subject to change without notice.
- This dimension does not include mold flash, protrusions, or gate burrs. Mold flash, protrusions, or gate burrs shall not exceed .006 [0.15] per side.
- This dimension does not include interlead flash.
- Reference JEDEC registration MS-012, variation AA.

# EXAMPLE BOARD LAYOUT

D0008A

SOIC - 1.75 mm max height

SMALL OUTLINE INTEGRATED CIRCUIT



LAND PATTERN EXAMPLE  
EXPOSED METAL SHOWN  
SCALE:8X



SOLDER MASK DETAILS

4214825/C 02/2019

NOTES: (continued)

- 6. Publication IPC-7351 may have alternate designs.
- 7. Solder mask tolerances between and around signal pads can vary based on board fabrication site.

# EXAMPLE STENCIL DESIGN

D0008A

SOIC - 1.75 mm max height

SMALL OUTLINE INTEGRATED CIRCUIT



SOLDER PASTE EXAMPLE  
BASED ON .005 INCH [0.125 MM] THICK STENCIL  
SCALE:8X

4214825/C 02/2019

NOTES: (continued)

8. Laser cutting apertures with trapezoidal walls and rounded corners may offer better paste release. IPC-7525 may have alternate design recommendations.
9. Board assembly site may have different recommendations for stencil design.



# EXAMPLE BOARD LAYOUT

YBJ0006

DSBGA - 0.35 mm max height

DIE SIZE BALL GRID ARRAY

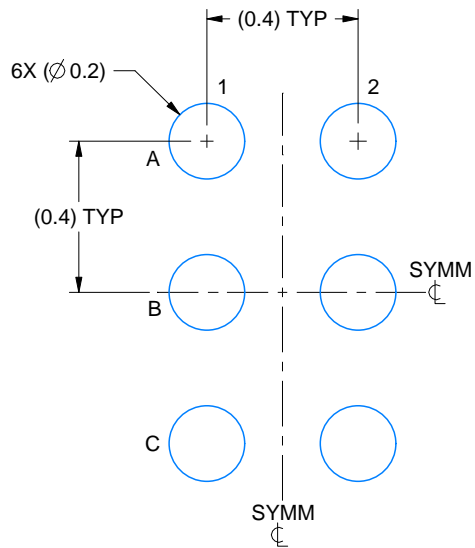

LAND PATTERN EXAMPLE  
EXPOSED METAL SHOWN  
SCALE: 50X

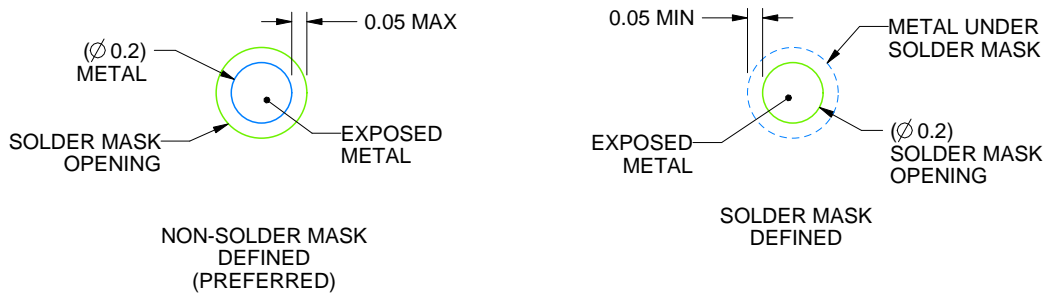

SOLDER MASK DETAILS  
NOT TO SCALE

4226653/A 03/2021

NOTES: (continued)

- Final dimensions may vary due to manufacturing tolerance considerations and also routing constraints. See Texas Instruments Literature No. SNVA009 ([www.ti.com/lit/snva009](http://www.ti.com/lit/snva009)).

# EXAMPLE STENCIL DESIGN

YBJ0006

DSBGA - 0.35 mm max height

DIE SIZE BALL GRID ARRAY

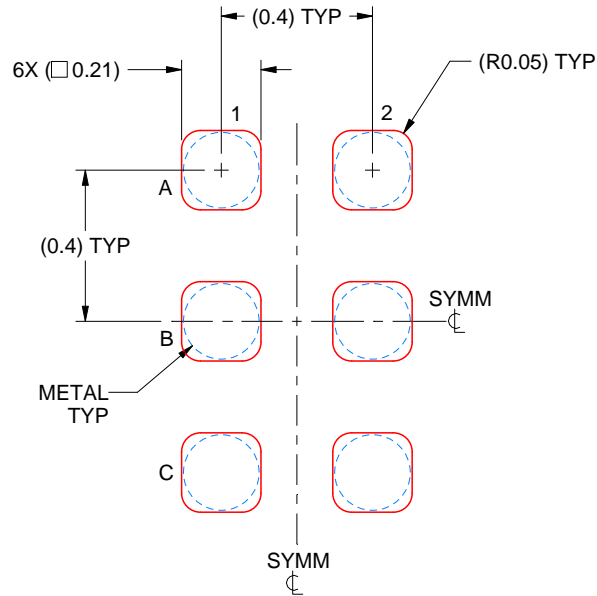

SOLDER PASTE EXAMPLE  
BASED ON 0.1 mm THICK STENCIL  
SCALE: 50X

4226653/A 03/2021

NOTES: (continued)

4. Laser cutting apertures with trapezoidal walls and rounded corners may offer better paste release.

## GENERIC PACKAGE VIEW

**DSG 8**

**WSON - 0.8 mm max height**

2 x 2, 0.5 mm pitch

PLASTIC SMALL OUTLINE - NO LEAD

This image is a representation of the package family, actual package may vary.  
Refer to the product data sheet for package details.

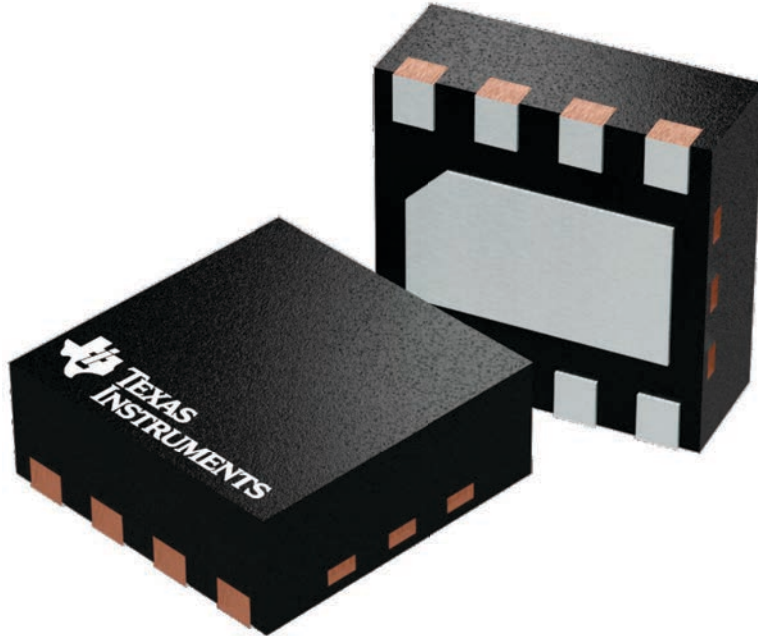

4224783/A

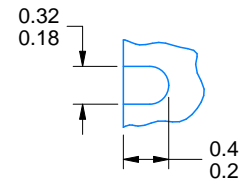
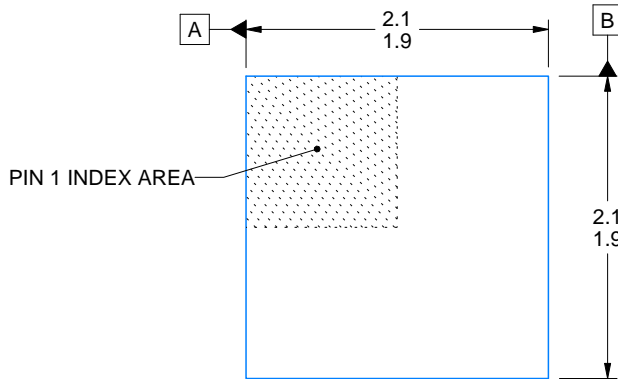
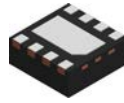

ALTERNATIVE TERMINAL SHAPE TYPICAL

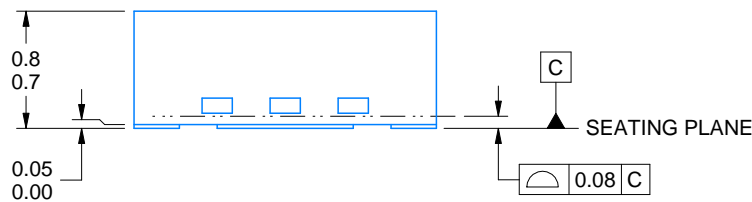

SIDE WALL METAL THICKNESS DIM A	
OPTION 1	OPTION 2
0.1	0.2

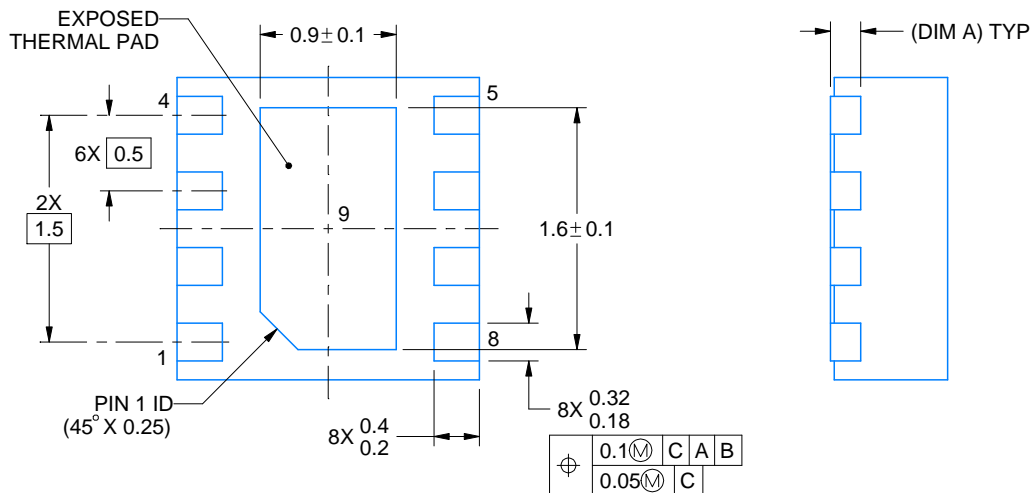

4218900/E 08/2022

NOTES:

1. All linear dimensions are in millimeters. Any dimensions in parenthesis are for reference only. Dimensioning and tolerancing per ASME Y14.5M.
2. This drawing is subject to change without notice.
3. The package thermal pad must be soldered to the printed circuit board for thermal and mechanical performance.

# EXAMPLE BOARD LAYOUT

DSG0008A

WSON - 0.8 mm max height

PLASTIC SMALL OUTLINE - NO LEAD

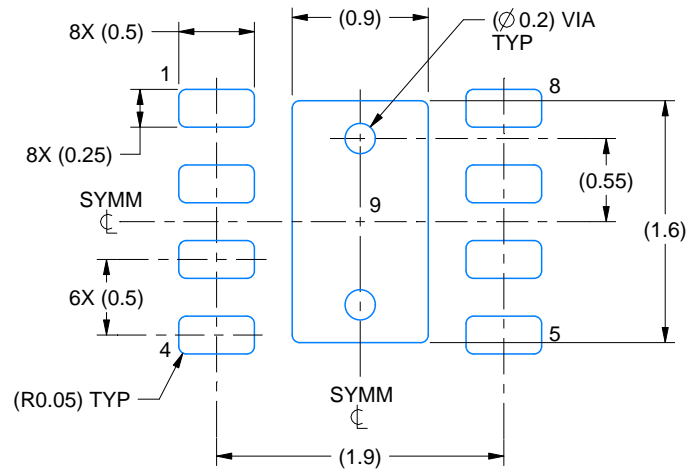

LAND PATTERN EXAMPLE  
SCALE:20X

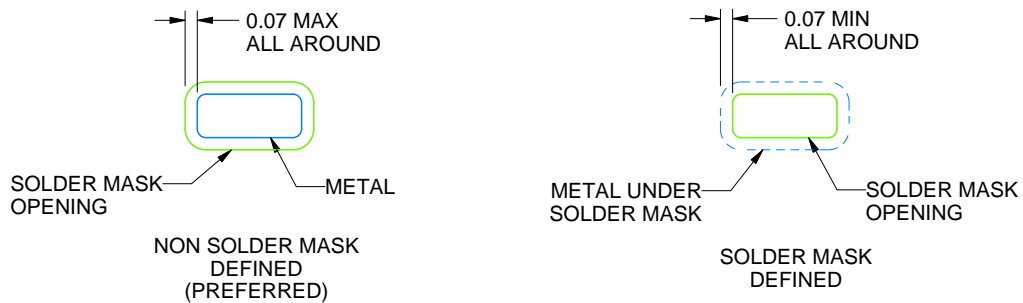

SOLDER MASK DETAILS

4218900/E 08/2022

NOTES: (continued)

- This package is designed to be soldered to a thermal pad on the board. For more information, see Texas Instruments literature number SLUA271 ([www.ti.com/lit/slua271](http://www.ti.com/lit/slua271)).
- Vias are optional depending on application, refer to device data sheet. If any vias are implemented, refer to their locations shown on this view. It is recommended that vias under paste be filled, plugged or tented.

# EXAMPLE STENCIL DESIGN

DSG0008A

WSON - 0.8 mm max height

PLASTIC SMALL OUTLINE - NO LEAD

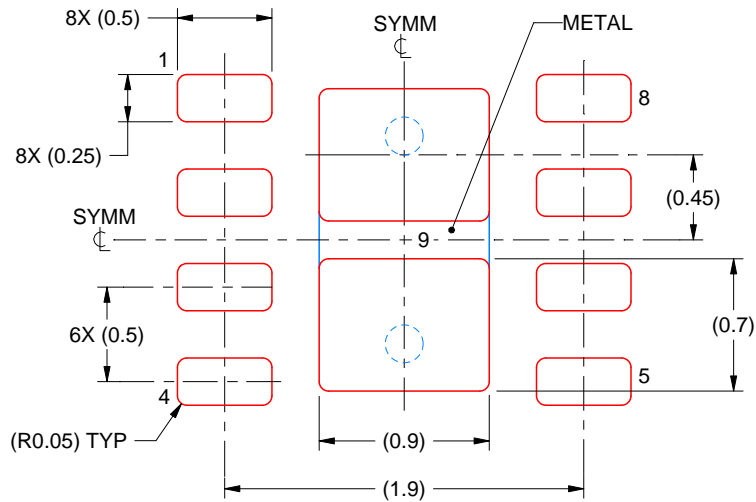

SOLDER PASTE EXAMPLE  
BASED ON 0.125 mm THICK STENCIL

EXPOSED PAD 9:  
87% PRINTED SOLDER COVERAGE BY AREA UNDER PACKAGE  
SCALE:25X

4218900/E 08/2022

NOTES: (continued)

6. Laser cutting apertures with trapezoidal walls and rounded corners may offer better paste release. IPC-7525 may have alternate design recommendations.

PW0014A

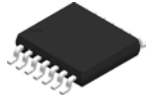

# PACKAGE OUTLINE

## TSSOP - 1.2 mm max height

SMALL OUTLINE PACKAGE

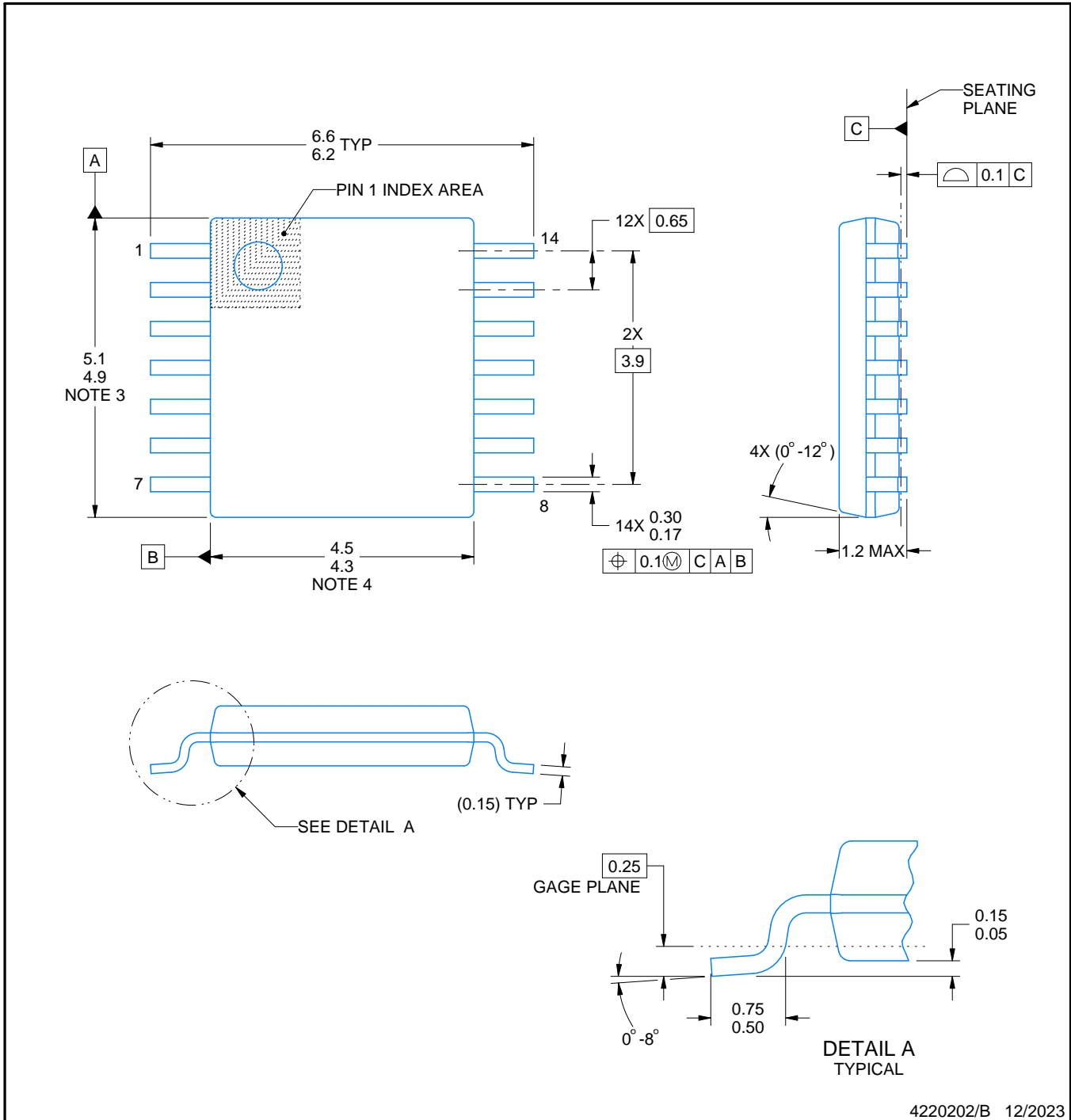

4220202/B 12/2023

NOTES:

1. All linear dimensions are in millimeters. Any dimensions in parenthesis are for reference only. Dimensioning and tolerancing per ASME Y14.5M.
2. This drawing is subject to change without notice.
3. This dimension does not include mold flash, protrusions, or gate burrs. Mold flash, protrusions, or gate burrs shall not exceed 0.15 mm per side.
4. This dimension does not include interlead flash. Interlead flash shall not exceed 0.25 mm per side.
5. Reference JEDEC registration MO-153.

# EXAMPLE BOARD LAYOUT

PW0014A

TSSOP - 1.2 mm max height

SMALL OUTLINE PACKAGE

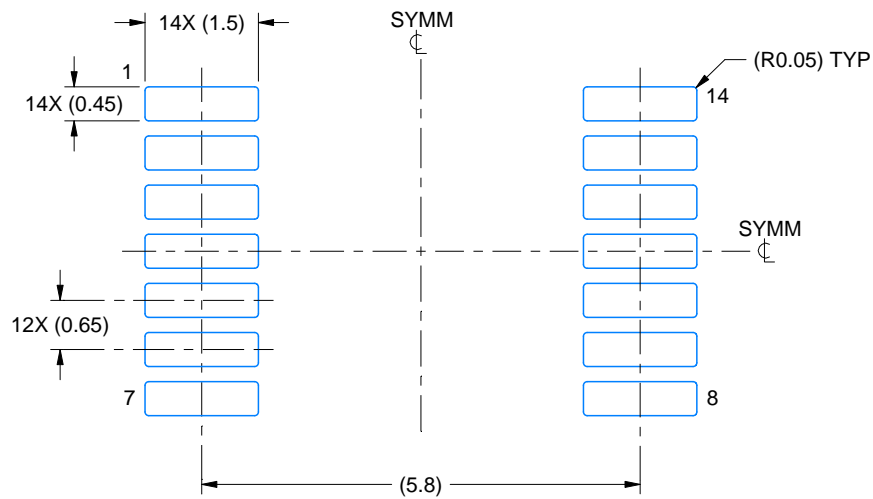

LAND PATTERN EXAMPLE  
EXPOSED METAL SHOWN  
SCALE: 10X

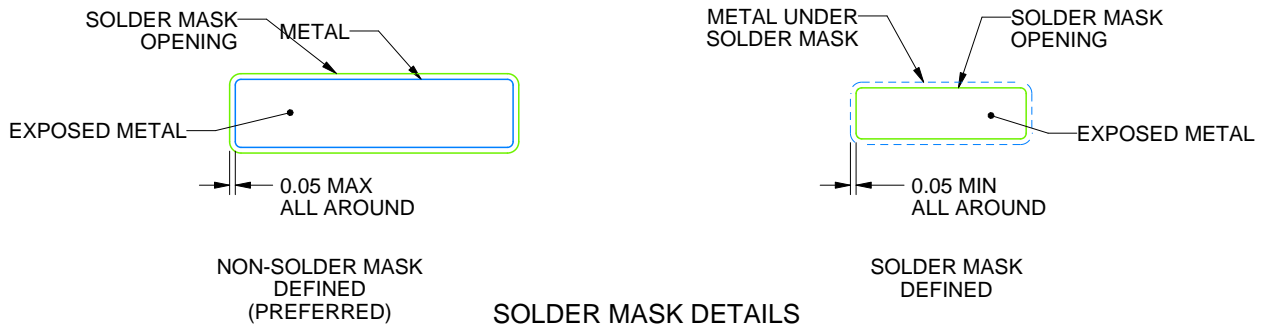

4220202/B 12/2023

NOTES: (continued)

- 6. Publication IPC-7351 may have alternate designs.
- 7. Solder mask tolerances between and around signal pads can vary based on board fabrication site.

# EXAMPLE STENCIL DESIGN

PW0014A

TSSOP - 1.2 mm max height

SMALL OUTLINE PACKAGE

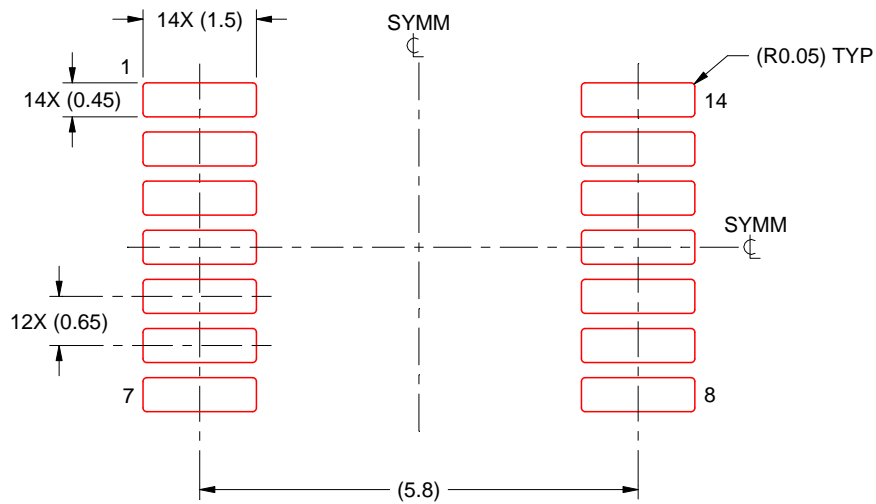

SOLDER PASTE EXAMPLE  
BASED ON 0.125 mm THICK STENCIL  
SCALE: 10X

4220202/B 12/2023

NOTES: (continued)

8. Laser cutting apertures with trapezoidal walls and rounded corners may offer better paste release. IPC-7525 may have alternate design recommendations.
9. Board assembly site may have different recommendations for stencil design.

## IMPORTANT NOTICE AND DISCLAIMER

TI PROVIDES TECHNICAL AND RELIABILITY DATA (INCLUDING DATA SHEETS), DESIGN RESOURCES (INCLUDING REFERENCE DESIGNS), APPLICATION OR OTHER DESIGN ADVICE, WEB TOOLS, SAFETY INFORMATION, AND OTHER RESOURCES "AS IS" AND WITH ALL FAULTS, AND DISCLAIMS ALL WARRANTIES, EXPRESS AND IMPLIED, INCLUDING WITHOUT LIMITATION ANY IMPLIED WARRANTIES OF MERCHANTABILITY, FITNESS FOR A PARTICULAR PURPOSE OR NON-INFRINGEMENT OF THIRD PARTY INTELLECTUAL PROPERTY RIGHTS.

These resources are intended for skilled developers designing with TI products. You are solely responsible for (1) selecting the appropriate TI products for your application, (2) designing, validating and testing your application, and (3) ensuring your application meets applicable standards, and any other safety, security, regulatory or other requirements.

These resources are subject to change without notice. TI grants you permission to use these resources only for development of an application that uses the TI products described in the resource. Other reproduction and display of these resources is prohibited. No license is granted to any other TI intellectual property right or to any third party intellectual property right. TI disclaims responsibility for, and you will fully indemnify TI and its representatives against, any claims, damages, costs, losses, and liabilities arising out of your use of these resources.

TI's products are provided subject to [TI's Terms of Sale](#) or other applicable terms available either on [ti.com](https://www.ti.com) or provided in conjunction with such TI products. TI's provision of these resources does not expand or otherwise alter TI's applicable warranties or warranty disclaimers for TI products.

TI objects to and rejects any additional or different terms you may have proposed.

Mailing Address: Texas Instruments, Post Office Box 655303, Dallas, Texas 75265

Copyright © 2025, Texas Instruments Incorporated